

修 订 NO	标 记 MARK	修 改 描 述 REVISION DESCRIPTION	签 名 SIGNATURE	日 期 DATE
		NEW DWG		2016-03-12

性能:

额定电流: 1A  
 额定电压: 100V  
 耐电压: 500V  
 接触电阻:  $\leq 20m\Omega$   
 绝缘电阻: 500M $\Omega$   
 工作温度:  $-20^{\circ}C \sim +85^{\circ}C$

塑件(材质): LCP, UL94V-0  
 插簧(材质): 黄铜, 镀锡  
 焊片(材质): 磷青铜, 镀锡

孔位	A	B	C
2	2.00	8.00	4.80
3	4.00	10.00	6.80
4	6.00	12.00	8.80
5	8.00	14.00	10.80
6	10.00	16.00	12.80
7	12.00	18.00	14.80
8	14.00	20.00	16.80
9	16.00	22.00	18.80
10	18.00	24.00	20.80
11	20.00	26.00	22.80
12	22.00	28.00	24.80

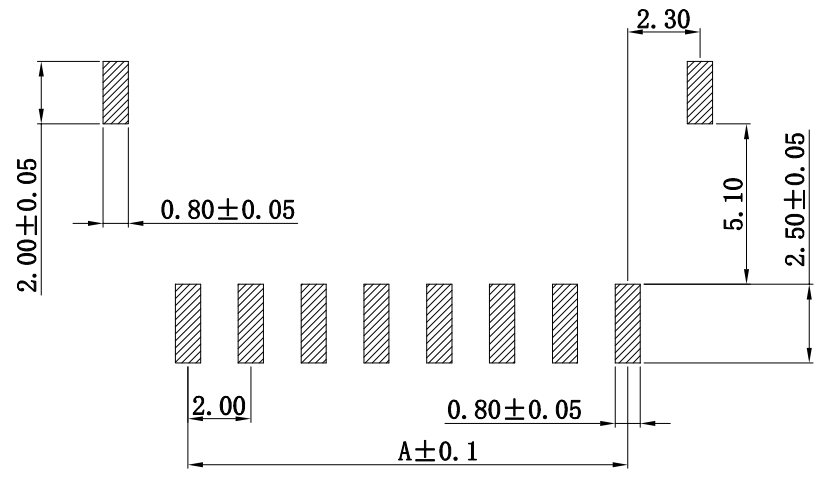
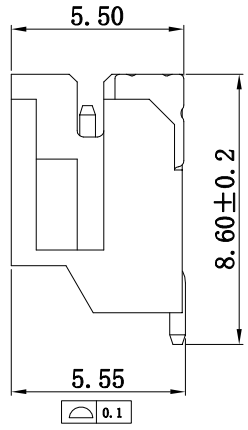
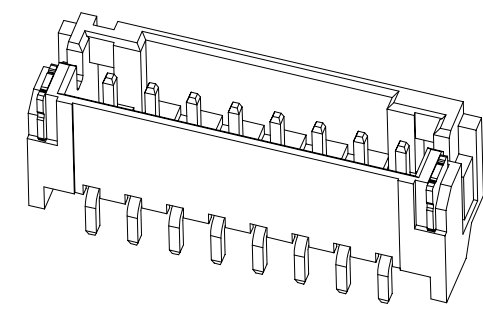
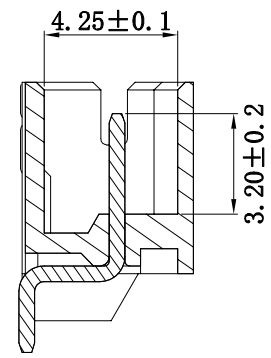
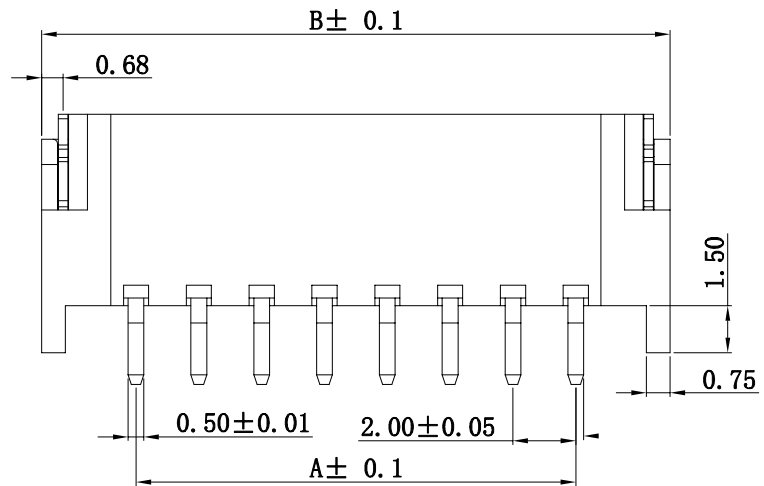
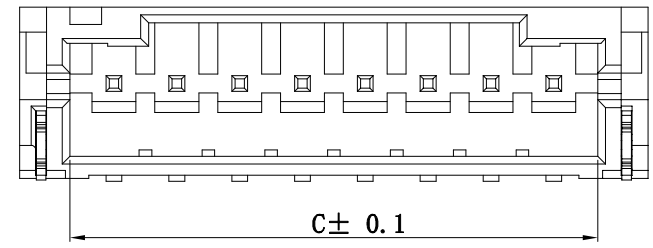

PCB LAYOUT



深圳市华德共创科技有限公司  
 Shenzhen Huade co-create Technology Co., LTD  
 电话: 0755-23304126 传真: 0755-29940187

-TOLERANCES- UNLESS OTHERWISE SPECIFIED 公差参数表		TITLE: 产品名称: 2.0 卧贴/wafer	
X.X ±0.30	X.X* ±3°	APPD: 核准:	PART NO: 产品编号: 2.0-A-nPWB
X.XX ±0.20	X.XX* ±2°	CHECK: 校对: 王建业	DATE SCALE UNIT CODE NUMBER
X.XXX ±0.10	X.XXX* ±1°	DRAW: 绘图: 黄艳兰	2016-03-12 1:1 mm A001