

REV	MARK	修改摘要	签名	日期
NO		REVISION DESCRIPTION	SIGNATURE	DATE
		NEW DWG		2016-03-12

孔位	A	B	C	D
2	1	3.15	7.2	9.1
3	2	4.15	8.2	10.1
4	3	5.15	9.2	11.1
5	4	6.15	10.2	12.1
6	5	7.15	11.2	13.1
7	6	8.15	12.2	14.1
8	7	9.15	13.2	15.1
9	8	10.15	14.2	16.1
10	9	11.15	15.2	17.1
11	10	12.15	16.2	18.1
12	11	13.15	17.2	19.1
13	12	14.15	18.2	20.1
14	13	15.15	19.2	21.1
15	14	16.15	20.2	22.1
16	15	17.15	21.2	23.1
17	16	18.15	22.2	24.1
18	17	19.15	23.2	25.1
19	18	20.15	24.2	26.1
20	19	21.15	25.2	27.1
21	20	22.15	26.2	28.1
22	21	23.15	27.2	29.1
23	22	24.15	28.2	30.1
24	23	25.15	29.2	31.1
25	24	26.15	30.2	32.1
26	25	27.15	31.2	33.1
27	26	28.15	32.2	34.1
28	27	29.15	33.2	35.1
29	28	30.15	34.2	36.1
30	29	31.15	35.2	37.1
31	30	32.15	36.2	38.1
32	31	33.15	37.2	39.1
33	32	34.15	38.2	40.1
34	33	35.15	39.2	41.1
35	34	36.15	40.2	42.1

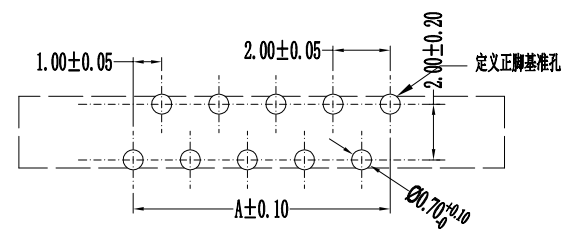
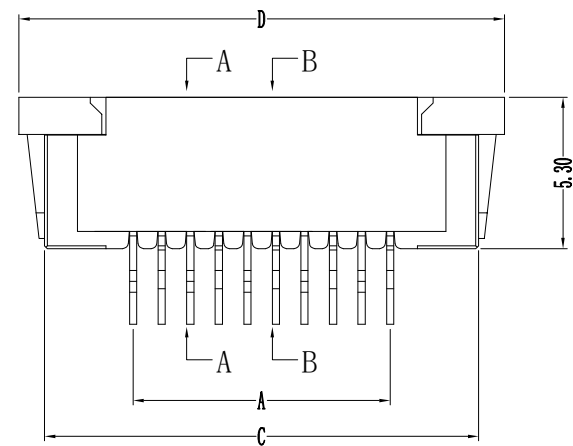
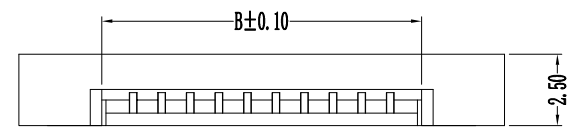

PCB Layout

性能:

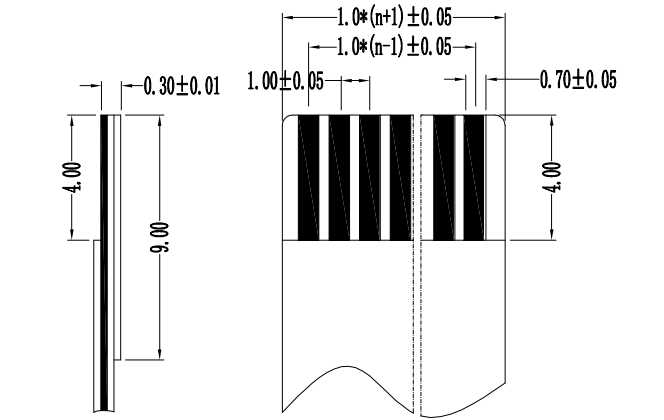
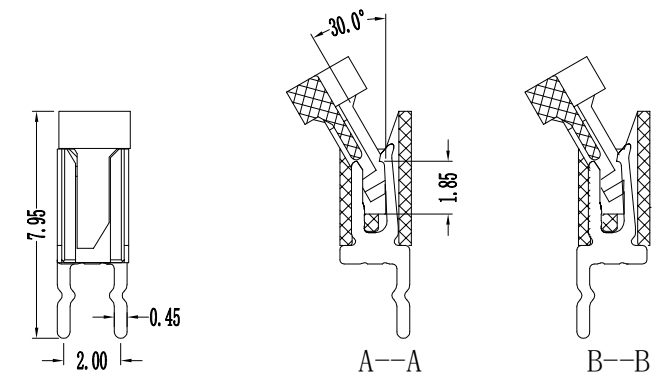

- 额定电流: 0.5A
- 额定电压: 50V
- 耐压: 500V
- 接触电阻: $\leq 20m\Omega$
- 绝缘电阻: 800M Ω
- 工作温度: $-20^{\circ}C \sim +85^{\circ}C$
- 塑件(材质): LCP, UL94V-0
- 锁扣(材质): LCP, UL94V-0
- 插簧(材质): 磷青铜, 镀锡/镀金



适用扁平电缆



深圳市华德共创科技有限公司
Shenzhen Huade co-create Technology Co., LTD
电话: 0755-23304126 传真: 0755-29940187

-TOLERANCES- UNLESS OTHERWISE SPECIFIED 公差参数表		 		TITLE: 产品名称: 1.0mm FPC (H型)直插式(正脚)				
X.X	± 0.30	X.X*	$\pm 3^{\circ}$	APPD: 核准:	PART NO: 产品编号: 1.0K-H-nP			
X.XX	± 0.20	X.XX*	$\pm 2^{\circ}$	CHECK: 校对: 王建业	DATE	SCALE	UNIT	CODE NUMBER
X.XXX	± 0.10	X.XXX*	$\pm 1^{\circ}$	DRAW: 绘图: 黄艳兰	2016-03-12	1:1	mm	A001