

ROHS

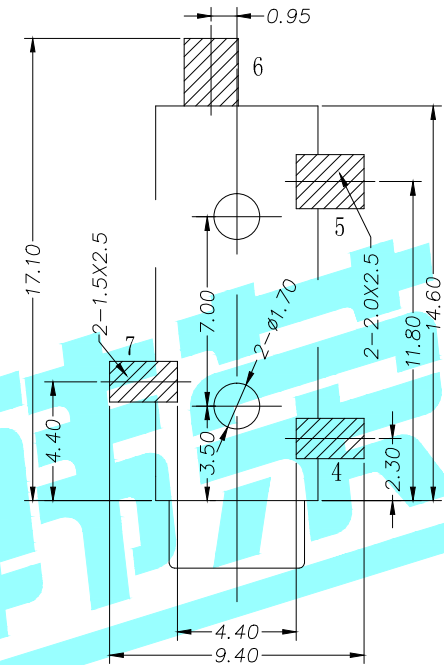

P.C.B Layout (copper-sided view)

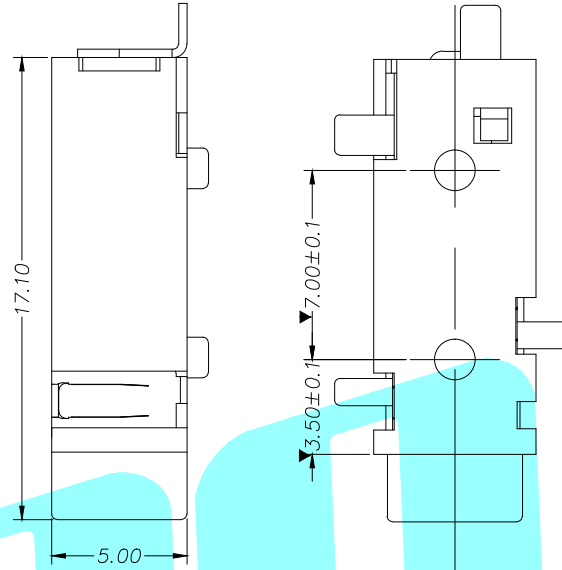
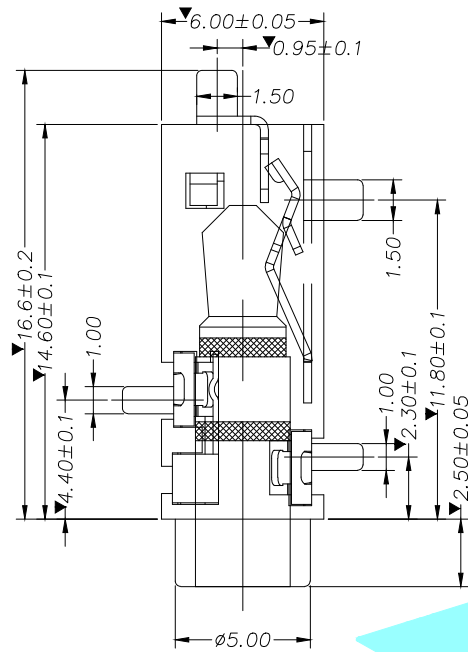
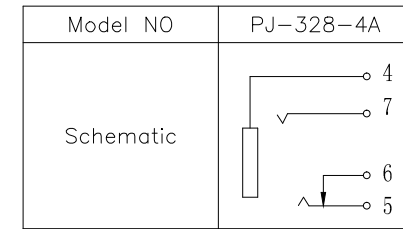
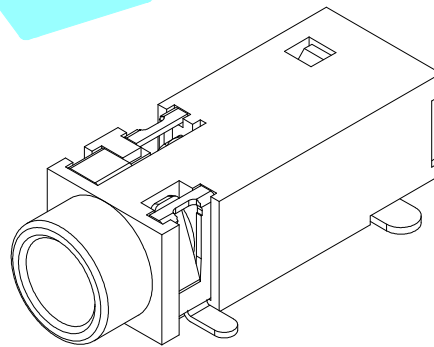
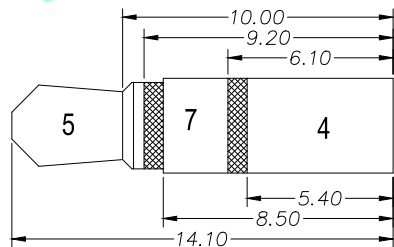
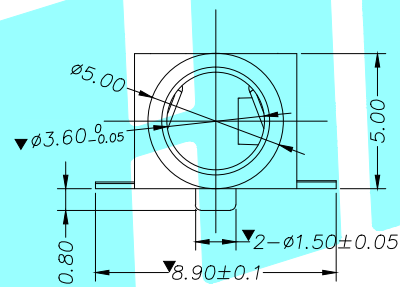

Rating:0.5A 30V DC
 Contact Resistance:100 mΩ Max.
 Operating temperature:-20℃~70℃
 Operating force:3-20N
 Operating Life:5,000cycles

②	Terminal	4	Phosphor bronze	Ag Plating													
①	Housing	1	PPA	Black													
ITEM	PART NAME	TER'NO.	QTY.	MATERIAL	FINISHING	REMARK											
APPROVALS			DATE	 ELECTRONICS CO.,LTD													
DRAWN	J.X.Zhang	2013/11/11					TITLE:	PHONE JACKES									
CHECKED				PART NO.	PJ-328-4A												
APPROVALS				TOLERANCES ARE	<table border="1"> <tr> <td>30~以上</td> <td>±0.30</td> <td rowspan="4">ANGLE</td> <td rowspan="4">UNIT: mm</td> <td rowspan="4">SCALE: 1:1</td> <td rowspan="4">PROJ: </td> </tr> <tr> <td>10~30</td> <td>±0.20</td> </tr> <tr> <td>5~10</td> <td>±0.15</td> </tr> <tr> <td>~ 5</td> <td>±0.10</td> </tr> </table>	30~以上	±0.30	ANGLE	UNIT: mm	SCALE: 1:1	PROJ:	10~30	±0.20	5~10	±0.15	~ 5	±0.10
30~以上	±0.30	ANGLE	UNIT: mm	SCALE: 1:1	PROJ:												
10~30	±0.20																
5~10	±0.15																
~ 5	±0.10																
ECN NO.	REV.	DATE.	DESCRIPTION.	CHANGE.	CHECK.	APPRO.											

_____	A	_____	NEW	_____	_____	_____
ECN NO.	REV.	DATE.	DESCRIPTION.	CHANGE.	CHECK.	APPRO.

