

RoHS

CAD GENERATED DRAWING. DON'T CHANGE BY HAND.

REV.	ECN. NO.	APPD.

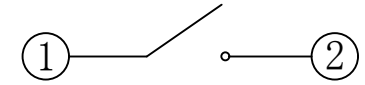
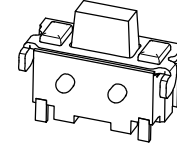
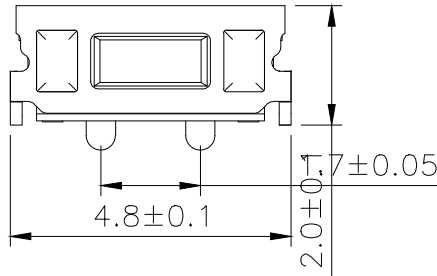
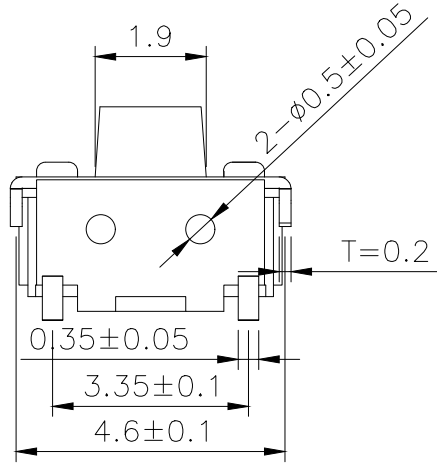
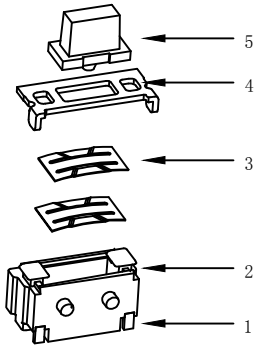

CIRCUIT DIAGRAM

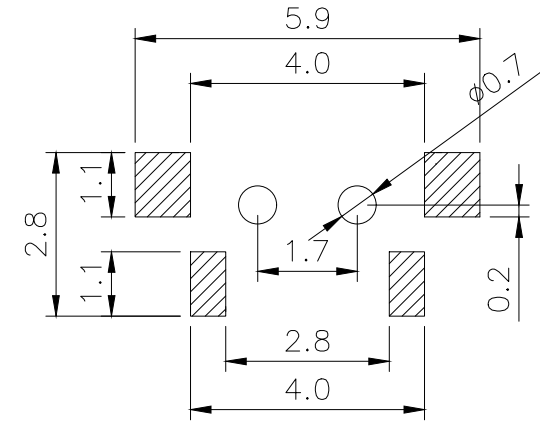
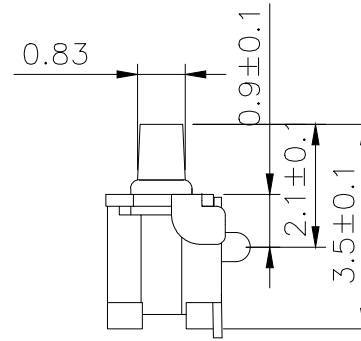

PCB. WELDING DRAWING

Specification

Rate voltage.current	50mA DC12V
Contact resistance	≤100mΩ
Operating force	160±50gf
Travel	0.20±0.10mm
Insulated resistance	≥100MΩ
Dielectric strength	≥250VAC/1min
Life cycle	≥30000次

ITEM	PART NAME	Q' TY	MATERIAL	FINSH/COLOR
5	Button	1	LCP	Black
4	Cover	1	Brass	Silver
3	Shrapnel	1	Stainless steel	Silver
2	Housing	1	LCP	White
1	Cards	1	Brass	Silver

X.	±0.50	X.°	±2°
.X	±0.30	.X°	±1°
.XX	±0.10	.XX°	±0.5°
.XXX	±0.05		

THESE DRAWINGS AND SPECIFICATIONS ARE THE PROPERTY OF YIYUAN TECHNOLOGY CO.,LTD AND SHALL NOT BE REPRODUCED, COPIED OR USED IN ANY MANNER WITHOUT THE PRIOR WRITTEN CONSENT OF YIYUAN TECHNOLOGY CO.,LTD

UNITS	mm	深圳市怡远科技有限公司 SHENZHEN YIYUAN TECHNOLOGY CO., LTD	TITLE:		
MAT'L			TACTILE SWITCH		
FINISH		PART NO.	TITLE:		
Q' TY		YTS-A002-1	TACTILE SWITCH		
		APPD: ROGER	DWG NO.:		
		CHKD: ROC	YTS-A002-1		
		DR: BILLY WANG 2020/08/21	SCALE	SHEET	REV.
			1/1	1/1	A1