



ATP22 Series Anti-Vandal Sealed Pushbutton Switch

NEW

Pushbutton
A

Features/Benefits

- Momentary or Lock version
- IP67 sealed & IK10 (Stainless steel bushing)
- Capable of up to 3A resistive load
- 50,000 life cycle at full load
- Various colors of LED illuminate indicator
- Choices of pushbutton with symbol on spot, ring or power logo

Typical Applications

- Control Panels including car park and traffic light
- Industrial Instruments
- Lifts / Escalator
- Communication equipment
- Alarm, safety and security systems



C&K US

Specifications

FUNCTION: Single pole and double poles
CONTACT ARRANGEMENT: N.O. and N.C.
MOUNTING TYPE: Threaded front panel mount
TORQUE FOR THREADED BODY: 5-14 Nm

Mechanical

OPERATING LIFE: Momentary 1,000,000 cycles
Self-lock 500,000 cycles
TOTAL TRAVEL: about 3.2 mm
OPERATING FORCE: 1 pole 2.5 ± 1N
2 pole 3.5 ± 1N

Electrical

CONTACT RATING: 1th 5A/250VAC
3A / 250VAC
3A / 28VDC
OPERATING LIFE: 50,000 make-and-break cycles at full load
DIELECTRIC STRENGTH: 2,000 V RMS @ sea level
INSULATION RESISTANCE: 1,000 MΩ min. @ 500 VDC
INITIAL CONTACT RESISTANCE : 50 mΩ max @1A 12VDC

Materials

BUSHING: Stainless steel / Aluminum alloy
BASE: PBT (UL 94-A0), PC (UL 94-V2)
ACTUATOR: PC; Stainless steel / Aluminum alloy
INTERNAL ASSEMBLY: POM / PA66
SPRING: Steel
SEALING / O-ring: Silicone
TERMINALS: Brass with silver or gold plated
CONTACT: Copper, silver plated

Operating Environment

OPERATING TEMPERATURE: -20°C to +55°C
SEALING / PROTECTION: IP67 / IK10 (Stainless steel bushing)

NOTE: Specifications and materials listed above are for switches with standard options. For information on specific and custom switches, please contact Customer Service.

Build-A-Switch

To order, simply select desired option from each category and place in the appropriate box.



Designation
ATP22 Series

Actuator Style
S Standard

Actuator Indicator
L0 Without LED
L3 Moving ring
L6 Ring LED*
L7 Ring LED + power logo**
L8 Ring LED + power logo***

Illumination

Color	Dual color
0 Without LED	A Red & Green
2 White	B Red & Blue
3 Red	D Blue & Yellow
5 Yellow	G Red & Yellow
6 Green	H Green & Yellow
7 Blue	J Orange & Green

LED voltage (20mA)

00 Without LED
03 3V
06 6V
12 12V
24 24V
36 36V
A1 110V AC
A2 220V AC

Terminal plating
Q Silver
G Gold

Termination

03 STD solder lug
W1 Wire lead 500mm****
W2 Wire lead 1,000mm****

Mechanical function

A Momentary
E Lock

Contact arrangement

S SPDT
D DPDT

Bushing type

B0 Stainless (Round)
B3 Al alloy: black anodized (Round)
M0 Stainless (Double D-shape)

* Available on ring color CAP of red/green/blue only.

** Power logo and ring with clear color CAP available on double D-shape bushing only.

*** Power logo and ring with red/green/blue color CAP available on double D-shape bushing only.

**** Available upon request, please contact your sales representative for details.

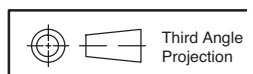

11 Apr 19

Dimensions are shown: mm (inches)
Specifications and dimensions subject to change

NEW

ATP22 Series Anti-Vandal Sealed Pushbutton Switch



A

Pushbutton

STANDARD VIEW

ROUND BUSHING

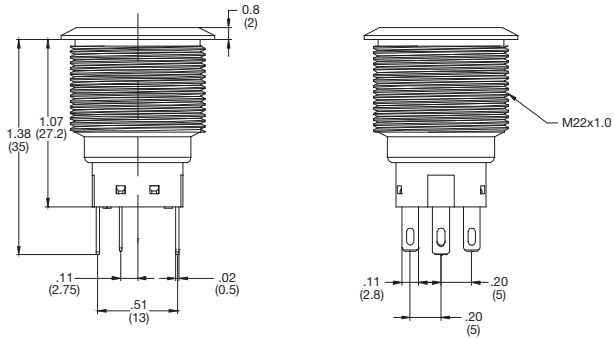

DOUBLE-D BUSHING

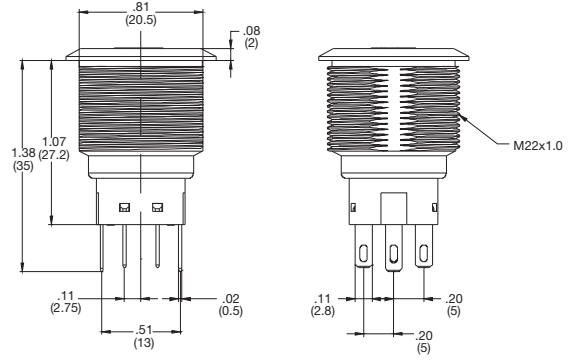

ACTUATOR STYLE

S STANDARD

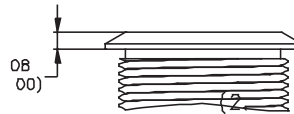

ACTUATOR INDICATOR

L0 WITHOUT LED

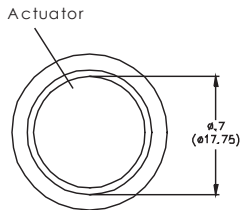

L3 & L6 RING LED

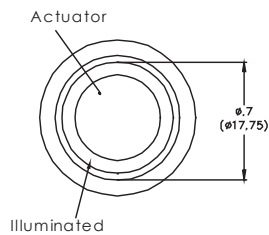

L7 & L8 POWER & RING

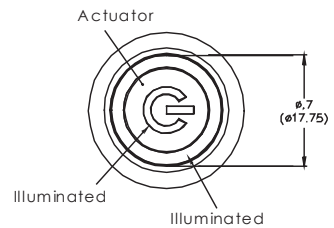



ATP22 Series Anti-Vandal Sealed Pushbutton Switch

NEW

Pushbutton
A

CIRCUIT

SPDT



SPDT - SINGLE COLOR LED

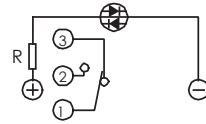

SPDT - DUAL COLOR LED

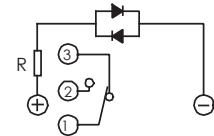

DPDT

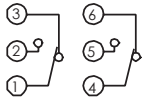

DPDT - SINGLE COLOR LED

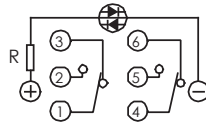

DPDT - DUAL COLOR LED

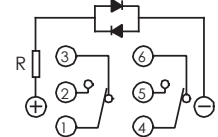

TERMINATION

03 SOLDERLUG

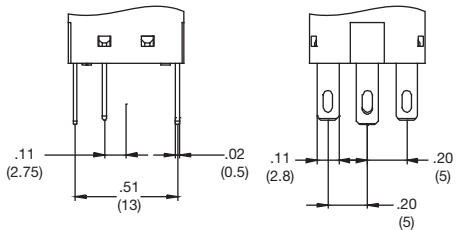

W1 OR W2 WIRE LEAD

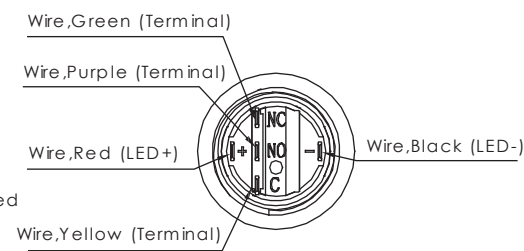
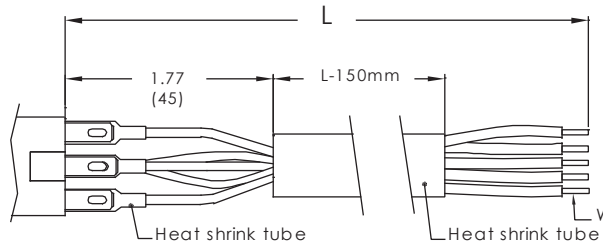

HARDWARE

HEX NUT

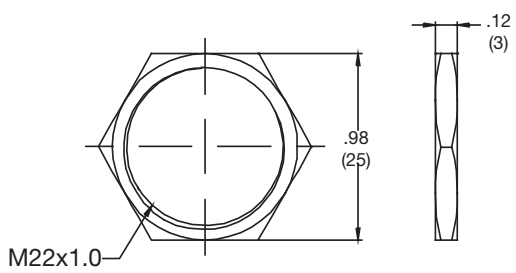

O - RING

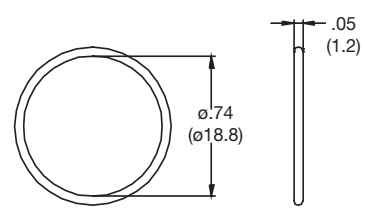

11 Apr 19

Dimensions are shown: mm (inches)
Specifications and dimensions subject to change