

Features

- 150 Watts peak pulse power ($t_p = 8/20\mu s$)
- Transient protection for high speed data lines to
- IEC 61000-4-2 (ESD) $\pm 30kV$ (air), $\pm 30kV$ (contact)
- IEC 61000-4-4 (EFT) 40A(5/50ns)
- Protects One Power or I/O Port
- Low leakage current
- Low operating and clamping voltages
- Solid-state silicon avalanche technology

Mechanical Characteristics

- Package: SOD-523
- Lead Finish: Matte Tin
- Case Material: "Green" Molding Compound.
- UL Flammability Classification Rating 94V-0
- Moisture Sensitivity: Level 3 per J-STD-020
- Terminal Connections: See Diagram Below
- Shipping Qty :3000pcs/7Inch Tape & Reel

Applications

- Cellular Handsets and Accessories
- Personal Digital Assistants
- Notebooks and Handhelds
- Portable Instrumentation
- Digital Cameras
- Peripherals
- Audio Players
- Keypads, Side Keys, LCD Displays, USB2.0

Dimensions and Pin Configuration

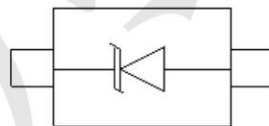

SOD-523 (Top View)

Absolute Maximum Ratings ($T_A=25^\circ\text{C}$ unless otherwise specified)

Parameter	Symbol	Value	Unit
ESD per IEC 61000-4-2 (Air)	VESD	± 30	kV
ESD per IEC 61000-4-2 (Contact)		± 30	
Operating Temperature Range	TJ	-55 to +125	$^\circ\text{C}$
Storage Temperature Range	Tstg	-55 to +150	$^\circ\text{C}$

Electrical Characteristics ($T_A=25^\circ\text{C}$ unless otherwise specified)

Symbol	Parameter
I_{PP}	Maximum Reverse Peak Pulse Current
V_C	Clamping Voltage @ I_{PP}
V_{RWM}	Working Peak Reverse Voltage
I_R	Maximum Reverse Leakage Current @ V_{RWM}
V_{BR}	Breakdown Voltage @ I_T
I_T	Test Current
I_F	Forward Current
V_F	Forward Voltage @ I_F
P_{pk}	Peak Power Dissipation
C	Capacitance @ $V_R = 0$ and $f = 1.0$ MHz

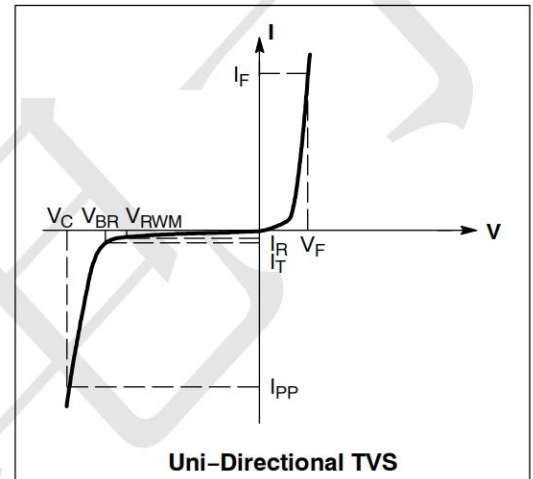

Parameter	Symbol	Min	Typ	Max	Unit	Test Condition
Reverse Working Voltage	V_{RWM}			15	V	
Breakdown Voltage	V_{BR}	16.5	15	20	V	$I_T = 1\text{mA}$
Reverse Leakage Current	I_R			0.2	μA	$V_{RWM} = 15\text{V}$
Clamping Voltage	V_C			24	V	$I_{PP} = 1\text{A}$ (8 x 20 μs pulse)
Clamping Voltage	V_C			40	V	$I_{PP} = 5\text{A}$ (8 x 20 μs pulse)
Junction Capacitance	CJ			35	pF	$V_R = 0\text{V}$, $f = 1\text{MHz}$

Characteristic Curves

Fig1. 8/20 μ s Pulse Waveform

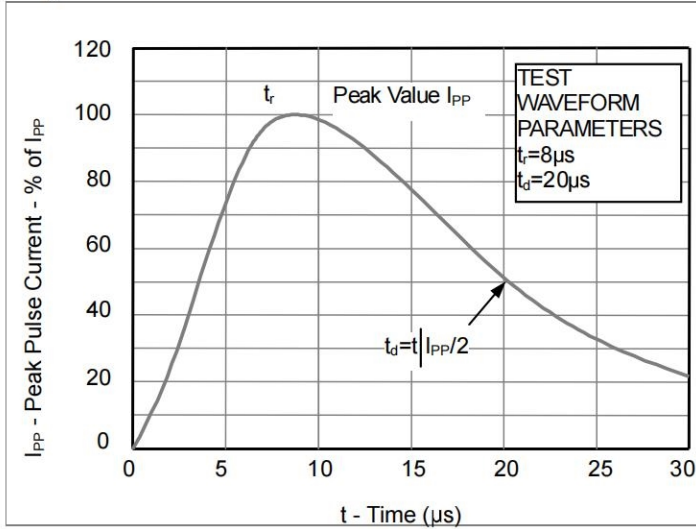

Fig2. ESD Pulse Waveform (according to IEC 61000-4-2)

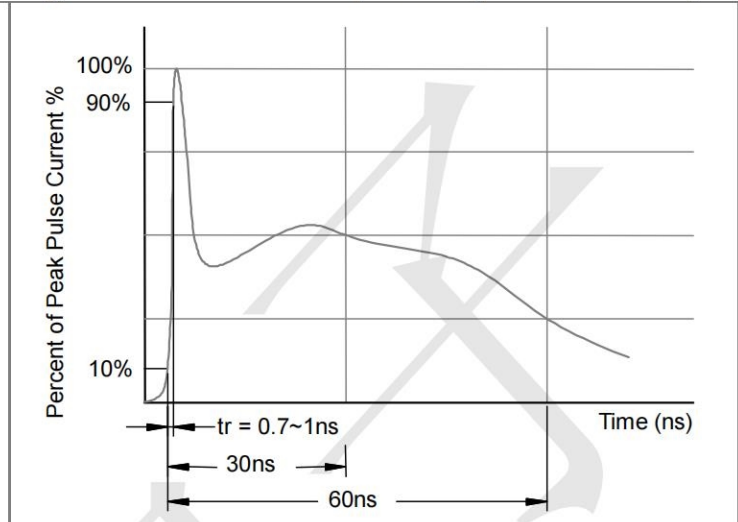
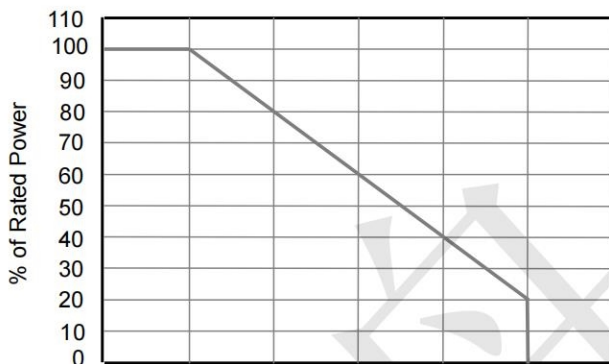
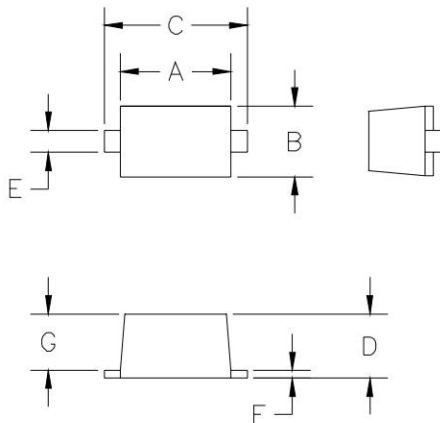

Fig3. Power Derating Curve



SOD-523 Package Outline Drawing



DIM ^N	INCHES		MM [1]		NOTE
	MIN	MAX	MIN	MAX	
A	.043	.051	1.10	1.30	—
B	.028	.035	0.70	0.90	—
C	.059	.067	1.50	1.70	—
D	.020	.028	0.50	0.70	—
E	.010	.014	0.25	0.35	—
F	.004	.008	0.10	0.20	—
G	.020	.028	0.50	0.70	—

[1] CONTROLLING DIMENSION: MILLIMETERS

Suggested Land Pattern

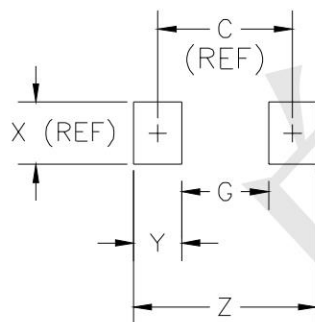

DIM ^N	INCHES		MM [1]		NOTE
	MIN	MAX	MIN	MAX	
C	—	.067	—	1.70	REF
G	—	.043	—	1.10	—
X	—	.031	—	0.80	REF
Y	—	.024	—	0.60	—
Z	—	.091	—	2.30	—

[1] CONTROLLING DIMENSION: MILLIMETERS