

6	7	8
版本	变更内容	工程确认
		日期

A

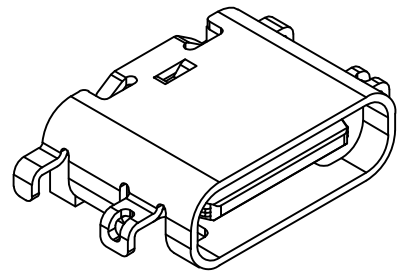
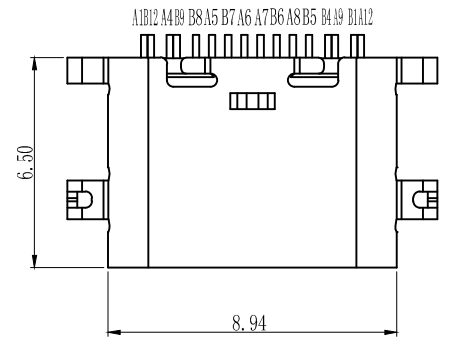

- TYPE C USB技术要求:
- 电气性能
 - 1.1 额定电流: 3A/5A.
 - 1.2 额定电压: 5V.
 - 1.3 耐压: 500 V(AC) for 1 min.
 - 1.4 接触阻抗: 40mΩ Max.
 - 1.5 可靠性和环境测试后阻抗变化不得超过10mΩ.
 - 1.6 绝缘阻抗: 100 MΩMin.
 - 机械性能
 - 2.1 插入力: 5-20N. 拔出力: 6-20N.
 - 2.2 寿命测试: 5000/10000cycles Max.
 - 2.3 推力: 50N min.
 - 2.4 剥离强度: 150N min.
 - 2.5 扭曲强度: 0.75Nm
 - 材料要求
 - 4.1 胶芯材料: LCP/PA9T
 - 4.2 外壳材料: SPCC/C2680/SUS304
 - 4.3 端子材料: C2680/C5191/C7025
 - 4.4 盐雾要求: 24H/48H
 - 4.5 工作温度: -20° C~85° C

B

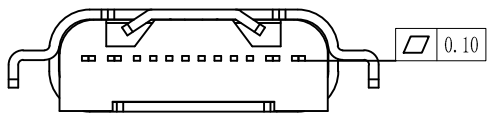
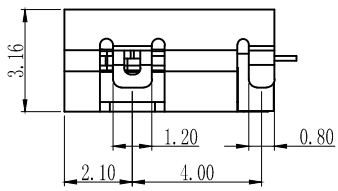
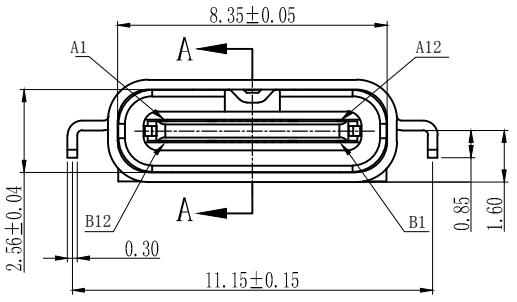

C

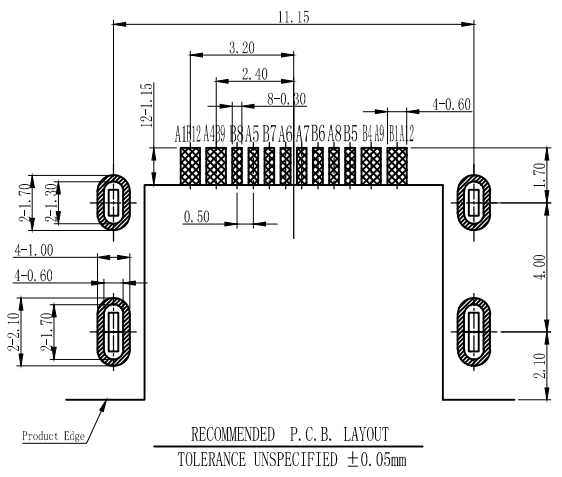
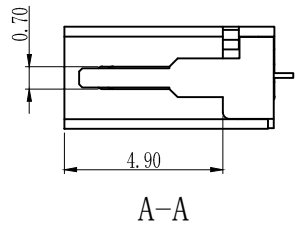

D

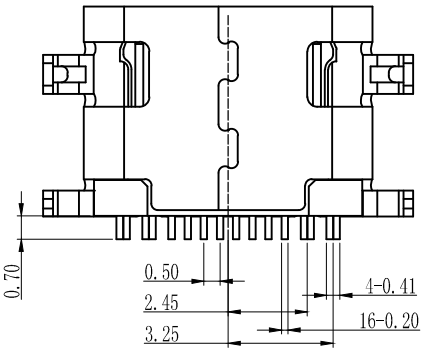

E

A1	GND	B12	GND
A4	VBUS	B9	VBUS
A5	CC1	B8	SBU2
A6	DP1	B7	DN2
A7	DN1	B6	DP2
A8	SBU1	B5	CC2
A9	VBUS	B4	VBUS
A12	GND	B1	GND
PIN	SIGNAL NAME	PIN	SIGNAL NAME

一般公差加工参考表

公司名称		东莞市博众电气有限公司	
		DONGGUAN BOZHONG ELECTRIC	
设计	LUO JIE	品名	Type C 母座 16P 沉板1.6
审核	ROGER LI	图号	BTC-TC16-34
核准	ROC ZHAO	版本	A
		页码	

F

