

版本	变更内容	工程确认	日期

MICRO USB技术要求:

- 电气性能
 - 额定电流 2A.
 - 额定电压: 5V.
 - 耐压: 500 V(AC) for 1 min.
 - 接触阻抗: 30 mΩ Max.
可靠性和环境测试后阻抗变化不得超过10mΩ.
 - 绝缘阻抗: 100 MΩmin.
- 机械性能
 - 插入力: 5~20N. 拔出力: 5~20N.
 - 寿命测试: 5000cycles.
 - 推力: 50N min.
 - 剥离强度: 150N min.
- 材料要求
 - 胶芯材料: LCP
 - 外壳材料: C2680/SPCC
 - 端子材料: C2680
- 盐雾要求: 24H
- 工作温度: -20° C~85° C

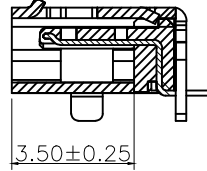
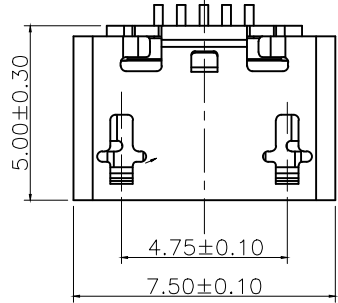

SECTION A-A(1:1)

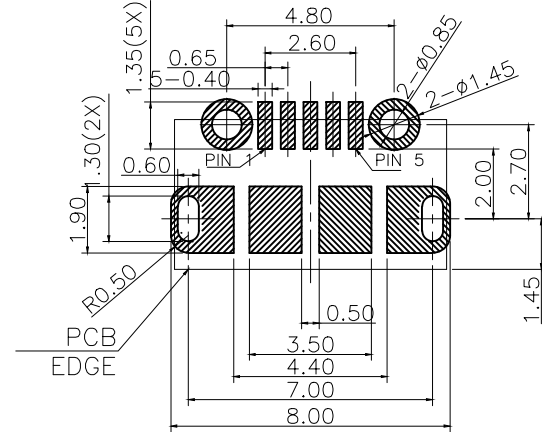
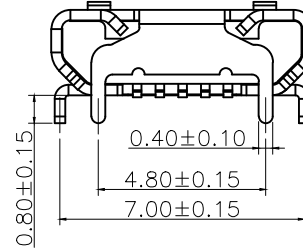
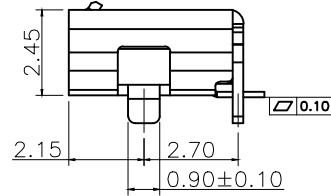
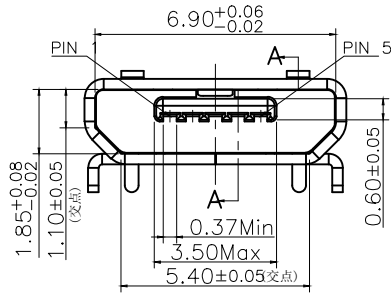

RECOMMENDED PCB LAYOUT
(GENERAL TOLERANCE: ±0.05mm)

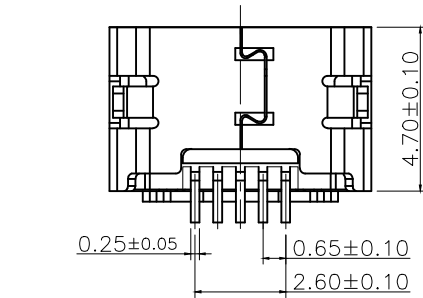

PART NO.	ITEM	PART NAME	Q'TY	MATERIAL
MIC00-000003	1	SHELL	1	BRASS,Continuous matte tin plating
	2	TERMINAL	5	BRASS,GOLD FLASH
	3	HOUSING	1	LCP,UL94V-0,BLACK
MIC00-000004	1	SHELL	1	BRASS,Matte tin plated roll
	2	TERMINAL	5	BRASS,GOLD FLASH
	3	HOUSING	1	LCP,UL94V-0,BLACK

一般公差加工参考表

⌀	□	单位	MM	比例
---	---	----	----	----

东莞市博众电气有限公司 DONGGUAN BOZHONG ELECTRIC			
设计	LUO JIE	品名	Micro 5P 牛角 直边 L=5.0 脚距4.8
审核	ROGER LI	图号	BTC-MC7S-43
核准	ROC ZHAO	版本	页码