



PARA LIGHT ELECTRONICS CO., LTD.

11F., No. 8, Jiankang Rd., Zhonghe Dist., New Taipei City 235, Taiwan,

Tel: 886-2-2225-3733

Fax: 886-2-2225-4800

E-mail: para@para.com.tw

www.paralighttaiwan.com

DATA SHEET

PART NO.: SZC195JYLGCT

REV: A / 1

CUSTOMER'S APPROVAL: _____

DCC: _____

DRAWING NO.: DS-79-16-001

DATE: 2020-8-4

PAGE

1 of 15

● PACKAGE OUTLINE DIMENSIONS

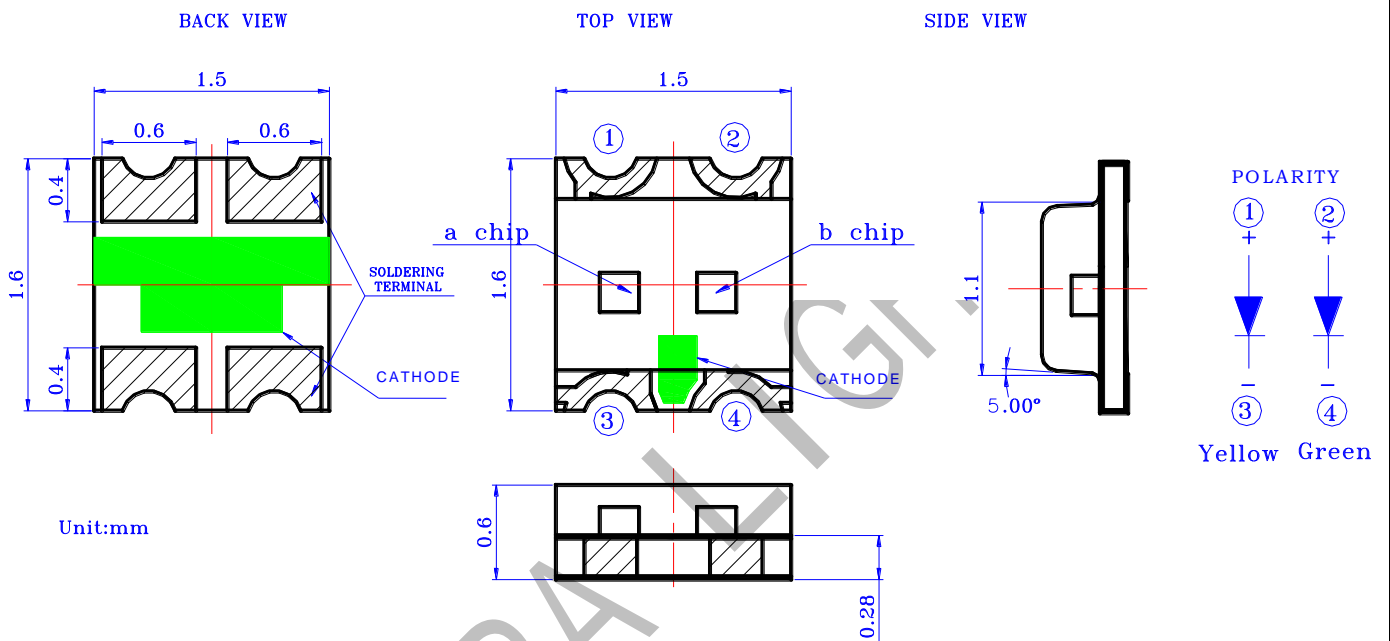

Notes:

1. a chip: Super Yellow; b chip: Super Green
2. All dimensions are in millimeters.
3. Tolerance is $\pm 0.1\text{mm}$ (.004") unless otherwise noted.

● Features

- * Dual color, top view, wide view angle Chip LED.
- * Package in 8mm tape on 7" diameter reels.
- * Compatible with automatic Pick & Place equipment.
- * Compatible with Reflow soldering and Wave soldering processes.
- * EIA STD package.
- * I.C. compatible.
- * Pb free product.
- * Moisture sensitivity level: 3

● **Chip Materials**

Chip	Light Color	Dice Material	Lens Color
a	JY: Super Yellow	AlInGaP	Water Clear
b	LG: Super Green	InGaN	

● **Absolute Maximum Ratings (Ta=25°C)**

Symbol	Parameter	Rating		Unit
		Super Yellow	Super Green	
PD	Power Dissipation	75	100	mW
IPF	Peak Forward Current (1/10 Duty Cycle, 0.1ms Pulse Width)	80	100	mA
IF	Continuous Forward Current	25	25	mA
-	De-rating Linear From 25°C	0.25	0.25	mA/°C
VR	Reverse Voltage	5	5	V
ESD	Electrostatic Discharge Threshold(HBM) ^{Note A}	2000	1000	V
Topr	Operating Temperature Range	-40 ~ +85		°C
Tstg	Storage Temperature Range	-40 ~ +85		°C

Note A:

HBM: Human Body Model. Seller gives no other assurances regarding the ability of to withstand ESD.

● **Electro-Optical Characteristics (Ta=25°C)**

Parameter	Symbol	Super Yellow	Super Green	Unit	Test Condition
Luminous Intensity	Min.	71	450	mcd	IF=20mA
	Typ.	100	540		
Viewing Angle	Typ.	2θ 1/2 130		deg	Note 2
Peak Wavelength	Typ.	λ p 591	518	nm	Measurement @Peak
Dominant Wavelength	Typ.	λ d 590	522	nm	IF=20mA
Spectral Line Half-Width	Typ.	Δ λ 16	15	nm	
Forward Voltage	Typ.	2.0	3.0	V	IF =20mA
	Max.	2.4	3.3		
Reverse Current	Max.	IR 10	50	μ A	VR = 5V

Notes:

1. Luminous intensity is measured with a light sensor and filter combination that proximates the CIE eye-response curve.
2. θ 1/2 is the off-axis angle at which the luminous intensity is half the axial luminous intensity.
3. The dominant wavelength λ_d is derived from the CIE chromaticity diagram and represents the single wavelength which defines the color of the device.
4. Caution in ESD:
Static Electricity and surge damages the LED. It is recommended use a wrist band or anti-electrostatic glove when handling the LED. All devices, equipment and machinery must be properly grounded.
5. Major standard testing equipment by "Instrument System" Model: CAS140B Compact Array Spectrometer and "KEITHLEY" Source Meter Model: 2400.

● Typical Electro-Optical Characteristics Curves

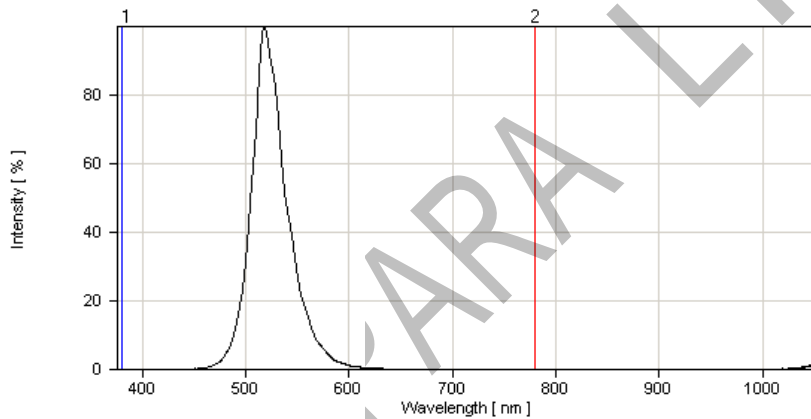

Fig.1 Super Green Relative Intensity vs. Wavelength

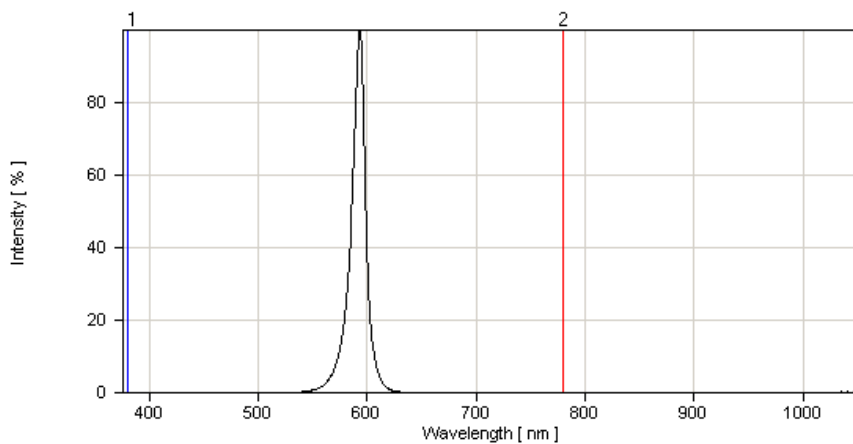

Fig.1 Super Yellow Relative Intensity vs. Wavelength

● Super Yellow Typical Electro-Optical Characteristics Curves

(25°C Ambient Temperature Unless Otherwise Noted)

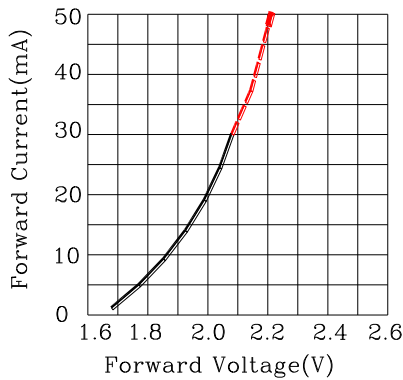

Fig.2 Forward Current vs.Forward Voltage

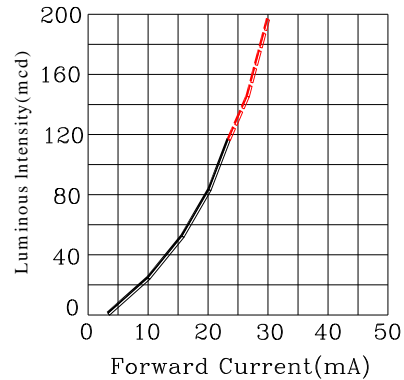

Fig.3 Luminous Intensity vs.Forward Current

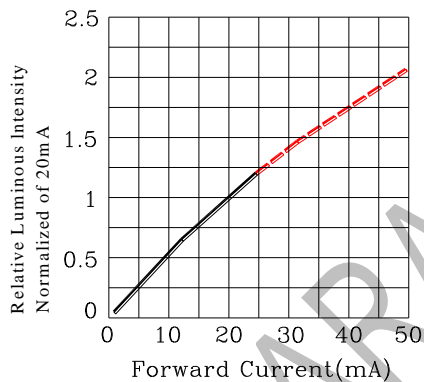

Fig.4 Relative Luminous Intensity vs.Forward Current

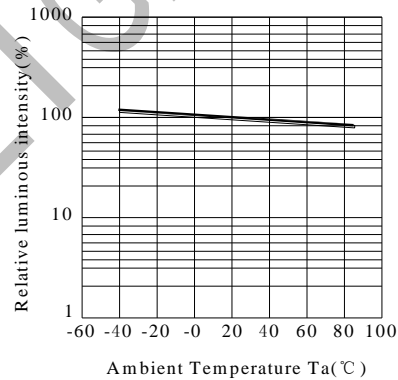

Fig.5 Luminous Intensity vs.Ambient Temperature

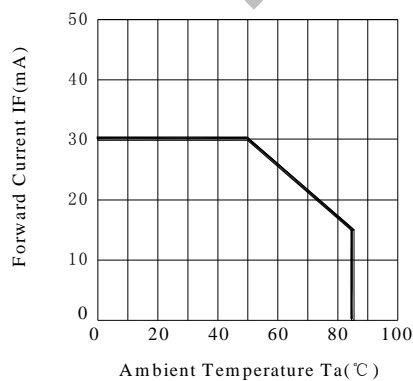

Fig.6 Forward Current Derating Curve

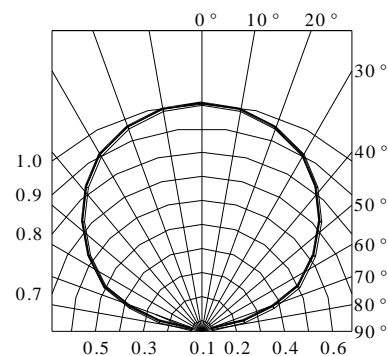

Fig.7 Relative Intensity vs.Angle

● **Super Green Typical Electro-Optical Characteristics Curves**

(25°C Ambient Temperature Unless Otherwise Noted)

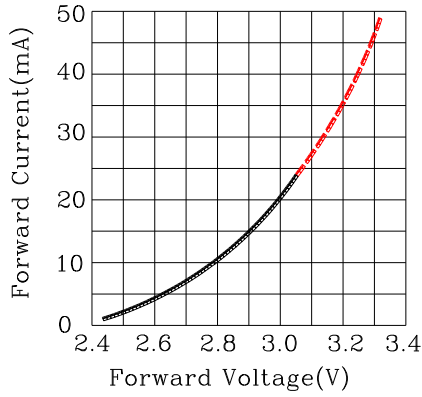

Fig.2 Forward Current vs.Forward Voltage

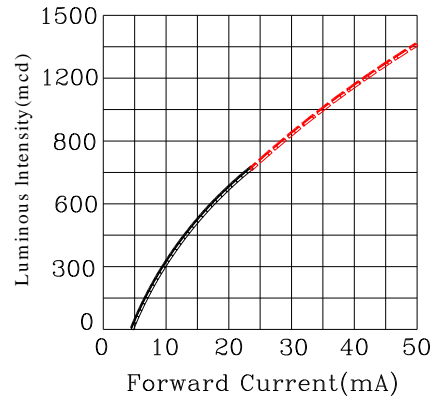

Fig.3 Luminous Intensity vs.Forward Current

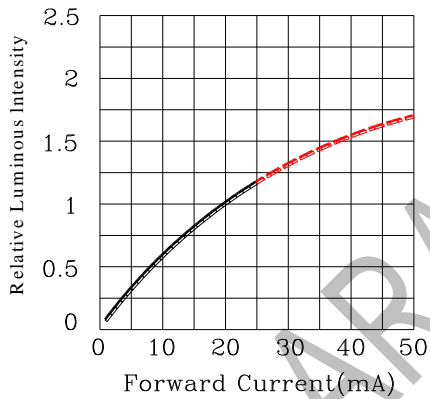

Fig.4 Relative Luminous Intensity vs.Forward Current

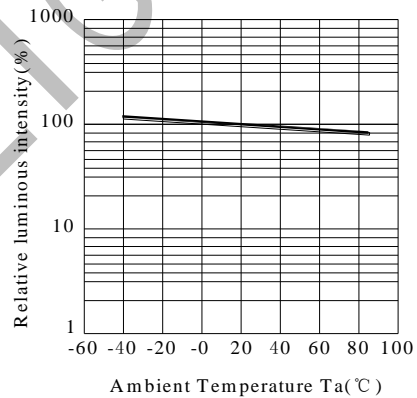

Fig.5 Luminous Intensity vs.Ambient Temperature

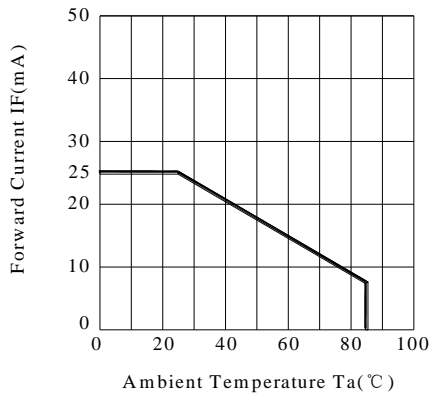

Fig.6 Forward Current Derating Curve

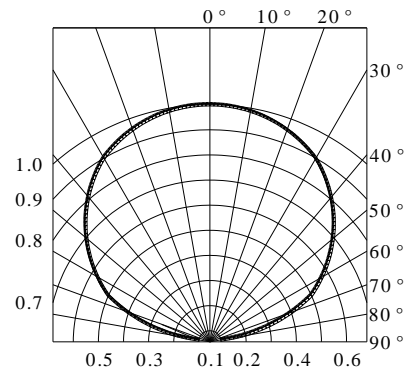

Fig.7 Relative Intensity vs.Angle

● Label Explanation



ITEM CODE:PARRA LIGHT

PART NO: SZC195JYLGCT

IV --- Luminous Intensity Code

LOT NO: EM S L 12 09 0110
 A B C D E F

A---EM: Emos Code

B---S:SMD

L---Local

D---Year

E---Month

F---SPEC.

PACKING QUANTITY OF BAG :

3000pcs for 150、170、110、155、115 series

4000pcs for 191 series

5000pcs for 192 series

DATE CODE: 2012 09 10
 G H I

G--- Year

H--- Month

I --- Day

● Reel Dimensions

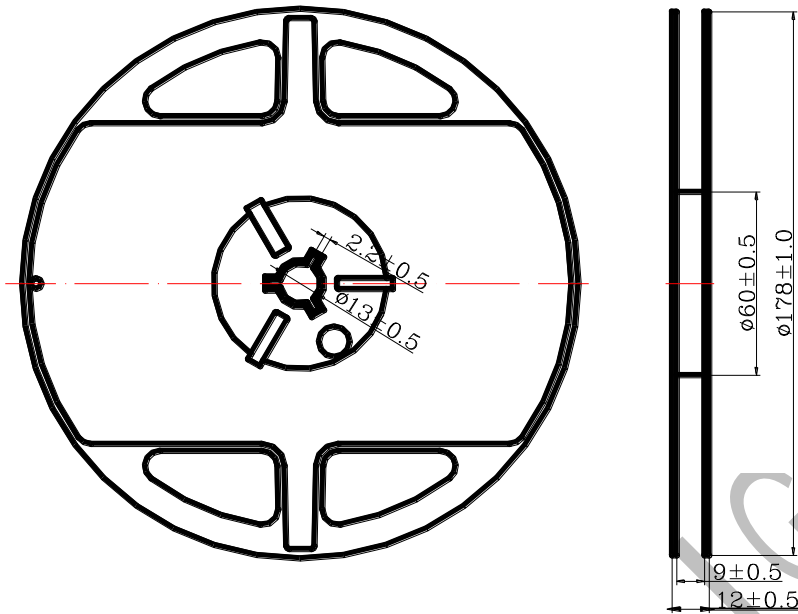

Notes:

1. Taping Quantity: 3000pcs
2. The tolerances unless mentioned is $\pm 0.1\text{mm}$, Angle $\pm 0.5^\circ$, Unit: mm.

● **Package Dimensions Of Tape And Reel**

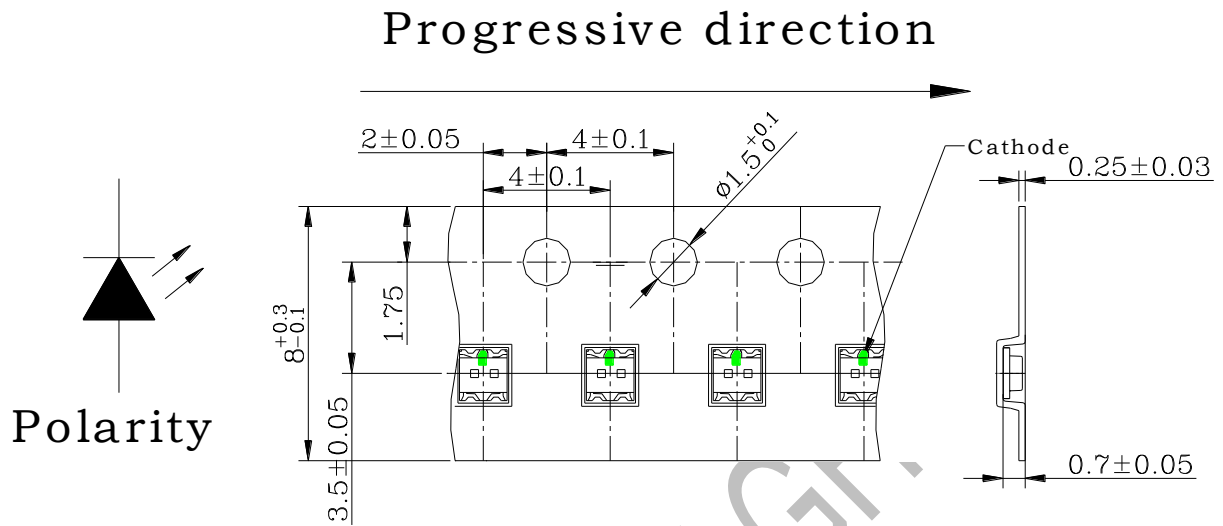

Notes: All dimensions are in millimeters.

Moisture Resistant Packaging

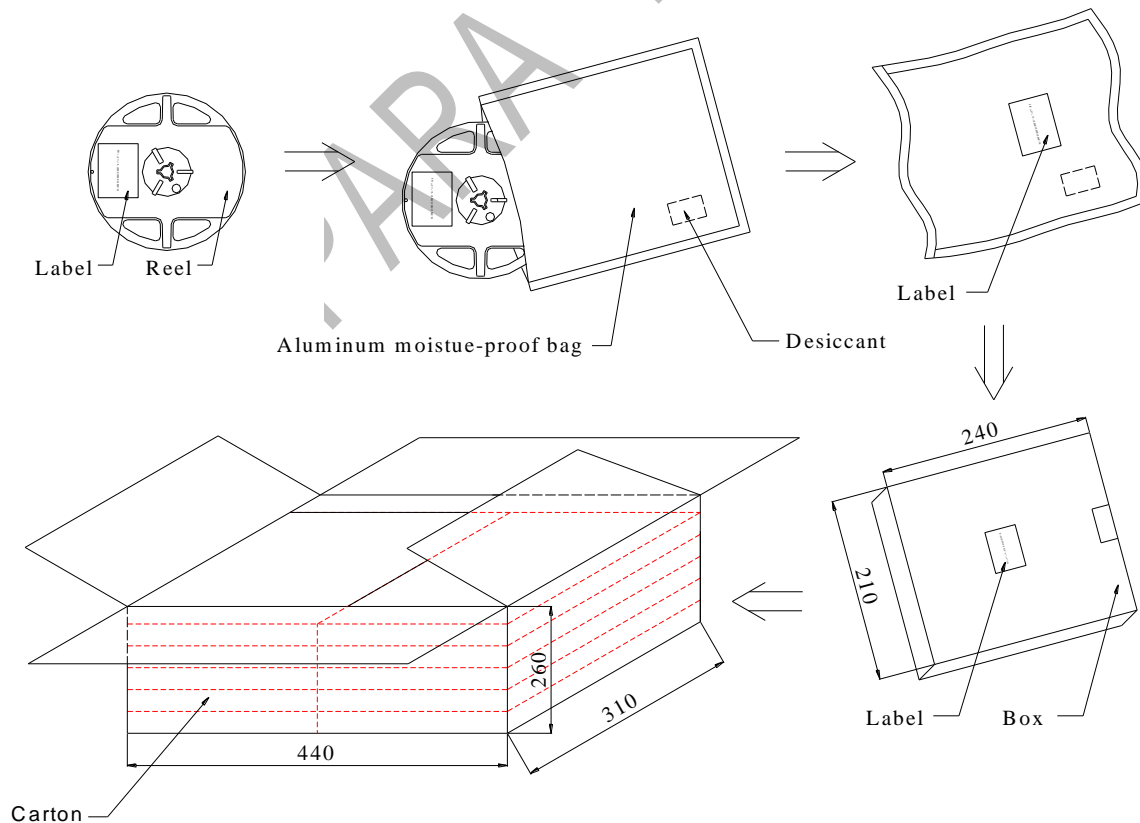

Notes : One reel in a bag, six bag in a inner box, six inner boxes in a carton. Unit : mm

● Cleaning

- * If cleaning is required , use the following solutions for less than 1 minute and less than 40°C.
- * Appropriate chemicals: Ethyl alcohol and isopropyl alcohol.
- * Effect of ultrasonic cleaning on the LED resin body differs depending on such factors as the oscillator output, size of PCB and LED mounting method. The use of ultrasonic cleaning should be enforced at proper output after confirming there is no problem.

● Suggest Soldering Pad Dimensions

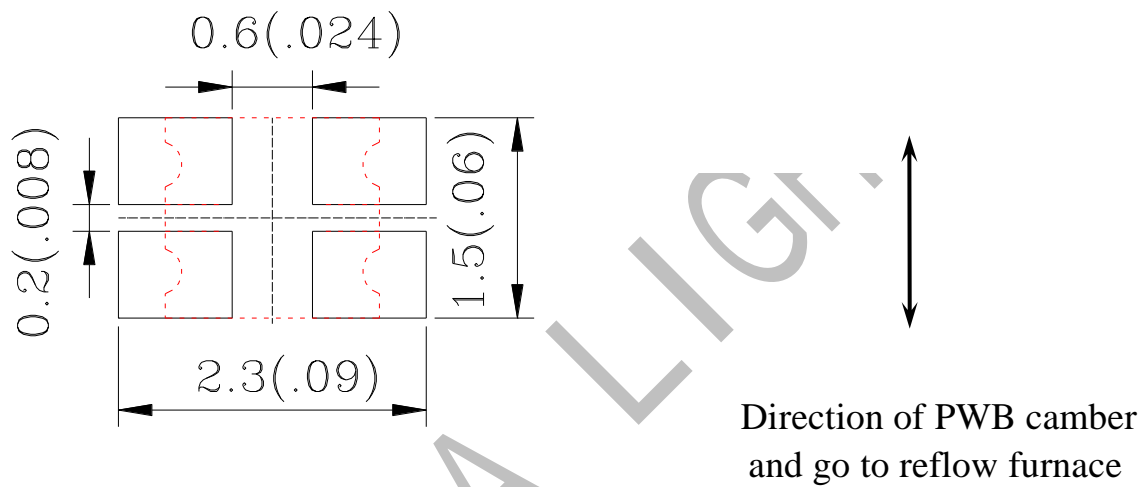

● Suggest Sn/Pb IR Reflow Soldering Profile Condition:

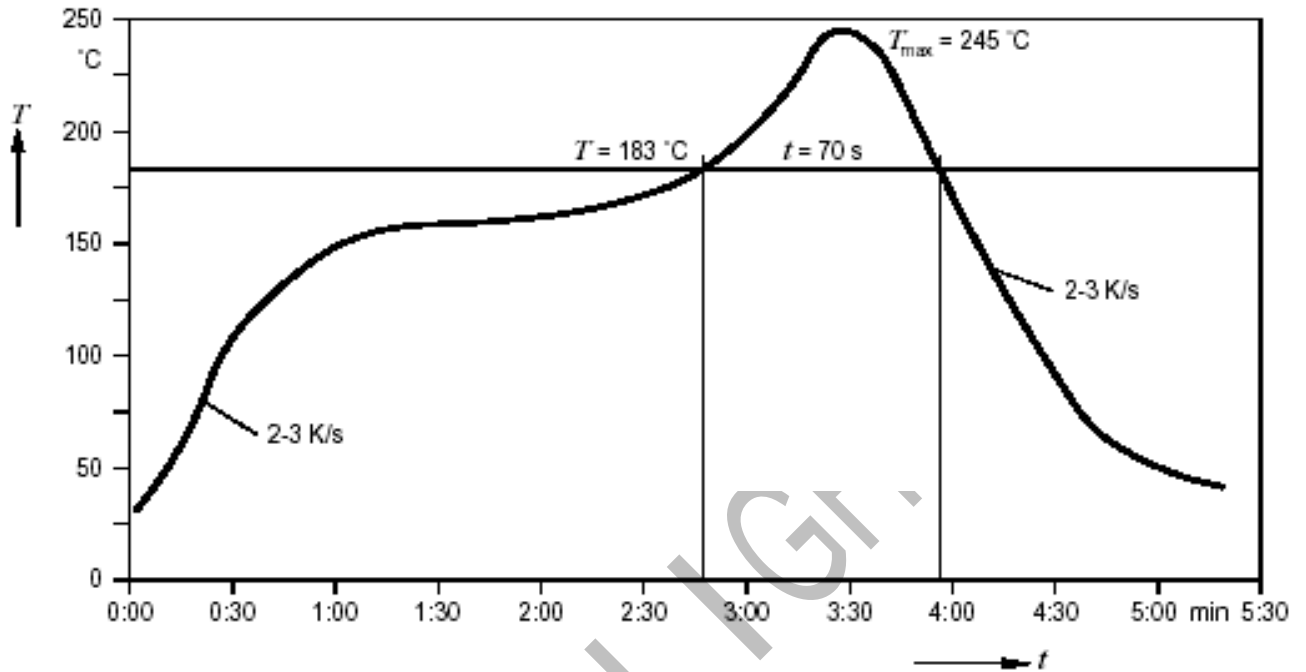

● Suggest Pb-Free IR Reflow Soldering Profile Condition:

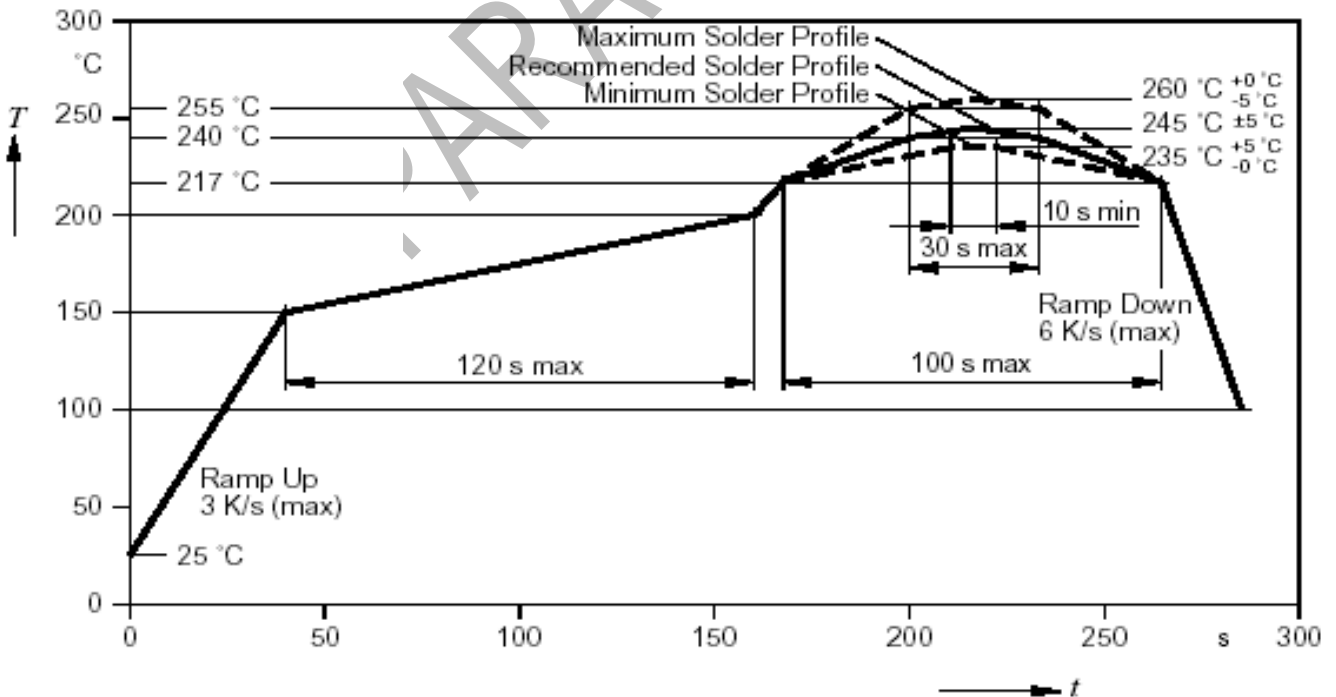

● **Bin Code List**

Luminous Intensity (IV), Unit: mcd@20mA					
Super Yellow (a chip)			Super Green (b chip)		
Bin Code	Min	Max	Bin Code	Min	Max
Q	71	112	U	450	710
R	112	180			

Tolerance of each bin are $\pm 15\%$

Forward Voltage(VF), Unit: V@20mA		
Super Green (b chip)		
Bin Code	Min	Max
13	2.8	2.9
14	2.9	3.0
15	3.0	3.1
16	3.1	3.2
17	3.2	3.3

Tolerance of each bin are ± 0.1 Volt

Dominant Wavelength (Hue),Unit: nm@20mA					
Super Yellow(a chip)			Super Gren (b chip)		
Bin Code	Min	Max	Bin Code	Min	Max
YA	587	590	AP	520	525
YB	590	593	AQ	525	530
YC	593	596			

Tolerance of each bin are ± 1 nm

CAUTIONS

1.Application Limitation:

The LED's described here are intended to be used for ordinary electronic equipment (such as office equipment, communication equipment and household application). Consult PARA's sales in advance for information on application in which exceptional quality and reliability are required, particularly when the failure or malfunction of the LED's may directly jeopardize life or health (such as airplanes, automobiles, traffic control equipment, life support system and safety devices).

2.Storage:

If the moisture absorbent material (silica gel) has faded away or the LEDs have exceeded the storage time, baking treatment should be performed using the following conditions.

Baking treatment: $60 \pm 5^\circ\text{C}$ for 24 hours

3. Soldering

Do not apply any stress to the lead frame during soldering while the LED is at high temperature.

Recommended soldering condition.

Reflow Soldering:

Pre-heat $120 \sim 150^\circ\text{C}$, 120sec. MAX., Peak temperature : 240°C Max. Soldering time: 10 sec Max.

Soldering Iron: (Not recommended)

Temperature 300°C Max., Soldering time : 3 sec. Max.(one time only), power dissipation of iron : 20W Max. use SN60 solder of solder with silver content and don't to touch LED lens when soldering.

Wave soldering:

Pre-heat 100°C Max, Pre-heat time 60 sec. Max, Solder wave 260°C Max, Soldering time 5 sec. Max. performed consecutively cooling process is required between 1st and 2nd soldering processes.

4. Lead-Free Soldering

For Reflow Soldering:

- 1 ∙ Pre-Heat Temp: $150 \sim 180^\circ\text{C}$, 120sec. Max.
- 2 ∙ Soldering Temp: Temperature Of Soldering Pot Over 230°C , 40sec. Max.
- 3 ∙ Peak Temperature: 260°C ∙ 5sec.
- 4 ∙ Reflow Repetition: 2 Times Max.
- 5 ∙ Suggest Solder Paste Formula 93.3 Sn/3.1 Ag/3.1 Bi /0.5 Cu

For Soldering Iron (Not Recommended):

- 1 ∙ Iron Tip Temp: 350°C Max.
- 2 ∙ Soldering Iron: 30w Max.
- 3 ∙ Soldering Time: 3 Sec. Max. One Time.

For Dip Soldering:

- 1 ∙ Pre-Heat Temp: 150°C Max. 120 Sec. Max.
- 2 ∙ Bath Temp: 265°C Max.
- 3 ∙ Dip Time: 5 Sec. Max.

5. Drive Method

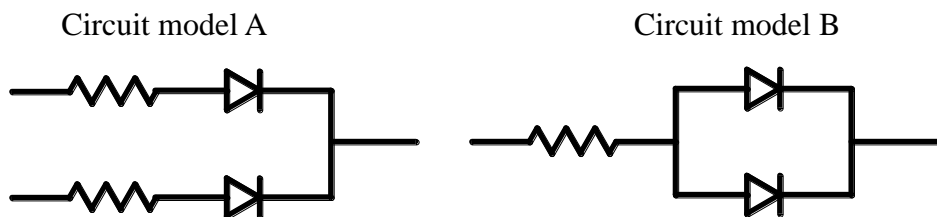

(A) Recommended circuit.

(B) The difference of brightness between LED's could be found due to the Vf-If characteristics of LED.



SURFACE MOUNT DEVICE LED

Part No.: SZC195JYLGCT

REV:A / 1

6. Reliability Test

Classification	Test Item	Test Condition	Reference Standard
Endurance Test	Operation Life	Ta= Under Room Temperature As Per Data Sheet Maximum Rating *Test Time= 1000HRS (-24HRS,+72HRS)*@20mA.	MIL-STD-750D: 1026 (1995) MIL-STD-883D: 1005 (1991) JIS C 7021:B-1 (1982)
	High Temperature High Humidity Storage	IR-Reflow In-Board, 2 Times Ta= 65±5°C, RH= 90~95% *Test Time= 1000HRS±2HRS	MIL-STD-202F: 103B(1980) JIS C 7021: B-11 (1982)
	High Temperature Storage	Ta= 105±5°C Test Time= 1000HRS (-24HRS, 72HRS)	MIL-STD-883D: 1008 (1991) JIS C 7021:B-10 (1982)
	Low Temperature Storage	Ta= -55±5°C *Test Time=1000HRS (-24HRS, 72HRS)	JIS C 7021:B-12 (1982)
Environmental Test	Temperature Cycling	105±5°C -55±5°C 10mins 10mins 100 Cycles	MIL-STD-202F: 107D (1980) MIL-STD-750D: 1051(1995) MIL-STD-883D: 1010 (1991) JIS C 7021: A-4 (1982)
	Thermal Shock	IR-Reflow In-Board, 2 Times 105±5°C -55°C±5°C 10mins 10mins 100 Cycles	MIL-STD-202F: 107D(1980) MIL-STD-750D: 1051(1995) MIL-STD-883D: 1011(1991)
	Solder Resistance	Tsol= 260 ±5°C Dwell Time= 10 ±1sec	MIL-STD-202F: 210A(1980) MIL-STD-750D: 2031(1995) JIS C 7021: A-1 (1982)
	Solder ability	Tsol= 235 ±5°C Immersion time 2±0.5 sec Immersion rate 25±2.5 mm/sec Coverage ≥95% of the dipped surface	MIL-STD-202F: 208D(1980) MIL-STD-750D: 2026(1995) MIL-STD-883D: 2003(1991) IEC 68 Part 2-20 JIS C 7021: A-2 (1982)

7. Others:

The appearance and specifications of the product may be modified for improvement without notice.



SURFACE MOUNT DEVICE LED

Part No.: SZC195JYLGCT

REV:A / 1

● PART NO. SYSTEM :

S Z C 1 9 1 X C X X - X X X X

XXXX : Special specification for customer

T : Taping for 7 inch reel
TC : Taping for 13 inch reel
TH : IV half binning
TP : Wavelength binning

Lens color
C : Water Clear
W : White Diffused
T : Color Transparent
D : Color Diffused

G : Gap 570nm Green
Y : GaAsp 585 nm Yellow
E : GaAsp 620 nm Orange
SR : GaAlAs 634 nm Red
KG : AlInGap 570nm Super Green
JY : AlInGap 590nm Super Yellow
KF : AlInGap 605nm Super Amber
KR : AlInGap 630 nm Super Red
LB : InGaN 470nm Blue
LG : InGaN 525nm Green

C : Top View Type
S : Side View Type

150 : 1206 1.1T Type
170 : 0805 0.8T Type
191 : 0603 0.6T Type
192 : 0603 0.4T Type
110 : 1206 1.0T Type
195 : 0605 0.6T Type