

文件名称: BTB Pitch 0.4mm Series Conn. SPEC

制订单位: 研发单位

文件编号: QRD-B001

制订日期: 2019.03.29

版 本: A

申请单位:

页 数: 16

修 订 记 录

修订日期	申请单号	修 订 内 容 摘 要	页次	版本
2019.03.29	/	新制订	1~16	A
核 准		审 查	制 订	
WX.L		Wilson	Hong.C	

1.0 Scope: This specification covers the requirements for product performance and test methods of WBXXX's Board To Board Pitch 0.4mm series Connectors of the part numbers specified as bellow. Product shall be of the design, construction and physical dimensions specified in the applicable product drawing.

本规格书包含了WBXXX板对板 Pitch 0.4mm 系列连接器的性能需求测试方法. 产品的设计, 结构, 形状和尺寸应该在适当的产品图面中进行描述.

2.0 Ordering information (产品编码):

PART NO.: SS XXX XX XX X
1 2 3 4 5

1	Series name (系列名称)	SS
2	Product serial number (产品系列)	256
3	Terminal spacing (端子间距)	40=0.4 间距
4	Pin number (接点数量)	10, 24, 30, 34, 40, 50, 60....
5	Interleaving mode 组合样式	M-公座, F-母座。

3.0 Connector Dimensions(外观尺寸):

See attached drawings.

参照附件图面.

4.0 Material(材质):

4.1 Housing(塑胶主体): LCP, UL94 V-0, BLACK; (LCP, 防火等级 V-0, 黑色)

4.2 Contacts(端子): Phosphor Bronze (磷青铜)

4.3 Stopper(固定片): Phosphor Bronze (磷青铜)

4.4 Plating(电镀方式): Gold plating, Nickel barrier (镀镍底, 选镀金)

5.0 Rating(等级):

5.1 Voltage Rating: 60V AC/DC

额定电压: 60 V AC / DC

5.2 Rated current : 0.3 A/pin (Max.)

额定电流: 0.3 A/pin (Max.)

5.3 Temperature Range: -40°C to +50°C storage; -55°C to +85°C operating

温度范围: -40°C to +50°C storage; -55°C to +85°C operating

测试湿度范围: 25% to 80%

6.0 Test Condition:(测试条件)

All tests shall be performed as bellow conditions unless otherwise specified.

所有测试依据以下规格条件执行, 特别说明规格除外。

6.1 Temperature range : +15°C to +35°C

测试温度范围: +15°C to +35°C

6.2 Humidity range: 25% to 80%

6.3 Atmospheric Pressure: 86kPa to 106 kPa (860 to 1060 m bar)

测试大气压力: 86kPa to 106 kPa (860 to 1060 m bar)

7.0 Test Methods and Requirements(测试方法和性能要求):

7.1 Examination of product(产品外观检验):

Item 项目	Test Description 测试描述	Test Methods 测试条件	Requirement 要求
7.1.1	Examination of product (Outward Appearance Structure) 产品外观结构检验	EIA 364-18 Shall be confirmed with eyes in accordance with each drawing. Shall be confirmed by using proper measuring instruments. 依照图面要求对产品目视检查, 再用测量工具按图面要求测量尺寸	1). Shall meet visual requirement, show no physical damage. 外观没有任何的物理损坏 2). Structure shall be meet the design and dimensional requirements of drawing. 外观结构应满足图纸的设计和尺寸要求

7.2 Electrical Performance(电器性能):

Item 项目	Test Description 测试描述	Test Methods 测试条件	Requirement 要求
7.2.1	Contact Resistance 接触阻抗	JIS C 5402 Make the BTB plugs and receptacles on board be fully mated ,then apply 20mV, 100mA current to the mated specimens , 将焊板的 BTB 公母端实配后通电测试, 电流及电压规格: 20mV, 100mA。测试公母端实配后接触阻抗	90 mΩ Maximum.
7.2.2	Insulation Resistance 绝缘阻抗	EIA 364-21 (or MIL-STD-202F, Method 302, Test Condition B) Apply a voltage of 250 VDC between adjacent terminals. of the plugs and receptacles. Electrification Time: 1 min 施加 250VDC 到公端&母端相邻两根端子之间, 通电时间: 1 分钟	1).Initial: 1000 MΩ Minimum. 2).After test: 100 MΩ Minimum. 初始值: 1000 MΩ Minimum. 测试后: 100 MΩ Minimum.
7.2.3	Dielectric Withstanding Voltage 耐电压	EIA 364-20 (or MIL-STD-202F, Method 301, Test Condition B) Apply a voltage of 150V AC between adjacent terminals. of the plugs and receptacles. Electrification Time: 1 min. 施加 150V AC 到公端&母端相邻两根端子之间, 通电时间: 1 分钟	1). samples no breakdown. 样品无击穿, 烧焦等不良. 2). Leakage current: 1mA Maximum 表面漏电: 1mA Maximum
7.2.4	Temperature rise 温升测试	EIA 364-20, Test Method B Connect series, Mate connector and measure the temperature rise at the rated current after 3 hours. 串联, 匹配连接器, 并量测在额定电流下通电 3 小时前后的温度升高的差异.	△T30℃ Maximum. (PER PIN)

7.3 Mechanical Performance (机械性能):			
Item 项目	Test Description 测试描述	Test Methods 测试条件	Requirement 要求
7.3.1	Vibration 震动测试	MIL-STD-202, Method-201 half-sine wave, apply 0.1 A DC current. frequency:10-55-10 Hz; amplitude: 1.52mm; sweep time:1 minute the connectors condition is PCB mounting and the plugs mated with receptacles , they must be tested 2 hours in each of the 3 axis(X,Y,Z),total 6 hours. 半正弦波, 通以 0.1ADC 电流。 测试频率:10-55-10 Hz; 振幅: 1.52mm 波形完成扫描时间:1 分钟; 将公母头配合好之 后在 X,Y,Z 3 个轴向各测试 2 小时, 共 6 小时。	1).Shall meet visual requirement, show no physical damage. 外观没有任何的物理损坏 2). Contact Resistance value After test: 90m Ω Maximum. 测试后电阻值: 90m Ω Maximum. 3).No discontinuities of 1 μ sec or longer duration. 导通瞬断不可超过 1.0 μ 秒
7.3.2	Physical Shock 机械冲击	EIA 364-27 Test Condition A Physical Shock EIA 364-27 Test Condition A (orMIL-STD-202F, Method 213) half-sine wave, apply 0.1ADC current Acceleration:50G(490m/s ²);duration: 11ms. the connectors condition is PCB mounting and the plugs mated with receptacles , shocking apply to 3 times in each of the 6 direction of 3 axis.18 total shock. 半正弦波, 通以 0.1ADC 电流。 测试的重力加速度:50G(490m/s ²) 测试时间: 11ms. 将焊接 PCB 公母头配合,在 X,Y,Z 三轴 6 个方向各冲击 3 次, 共 18 次	1).Shall meet visual requirement, show no physical damage. 外观没有任何的物理损坏 2). Contact Resistance value After test: 90m Ω Maximum. 测试后电阻值: 90m Ω Maximum. 3).No discontinuities of 1 μ sec or longer duration. 导通瞬断不可超过 1.0 μ 秒
7.3.3	Durability 寿命测试	EIA 364-09 Make the specimens that are on board mated, then fix the receptacles to the machine on horizontal or perpendicular direction. Use the machine catch the plugs and separate the specimens, then make the plugs be fully mated with receptacles at a rate of 25.4 mm/min on horizontal or perpendicular direction.duration:30 cycles 将焊板的 BTB 公端与母端组合后, 将母端水 平或垂直固定在测试仪器, 用仪器夹住公端分 离后再将公端以水平或垂直插入焊板母端到 位, 测试速度 25.4 mm/min, 循环 30 次	1).Shall meet visual requirement, show no physical damage. 外观没有任何的物理损坏 2). Contact Resistance value After test: 90m Ω Maximum. 测试后电阻值: 90m Ω Maximum

BTB Pitch 0.4mm Series CONN

7.3.4	Connector Mating & Unmating Force 插入/拔出力	EIA 364-13 Make the specimens that are on board mated, then fix the receptacles to the machine on horizontal or perpendicular direction. Use the machine catch the plugs and separate the specimens, then make the plugs be fully mated with receptacles at a rate of 25.4 millimeters/minute on horizontal or perpendicular direction. 将焊板的 BTB 公端与母端组合后，将母端水平或垂直固定在测试仪器，用仪器夹住公端分离后再将公端以水平或垂直插入焊板母端到位，测试速度 25.4 mm/min	Mating force(插入力): 100g Max 【0.981N】 /Pin X N. (N means pin numbers) 100g Max 【0.981N】 /Pin X N (N =产品 pin 数) Unmating force: 30g Min 【0.29N】 /Pin X N. (N means pin numbers) 30g Min 【0.29N】 /Pin X N. (N =产品 pin 数)
7.3.5	Contact Retention Force 端子保持力	EIA 364-35 The pull speed shall 25.4 mm per minute on the terminal assembled in the housing 以 25.4 mm/min 的速度，将组装在胶芯内的以垂直方向端子拔出	0.20 N/Pin Minimum.

7.4 Environmental performance (环境性能)

Item 项目	Test Description 测试描述	Test Methods 测试条件	Requirement 要求															
7.4.1	Thermal Shock 热冲击	EIA 364-32, Test Condition I (or MIL-202F, Method 107G Condition A.) specimens shall be separated and exposed 5 cycles as the following table conditions. 将测试样本公母端分离暴露条件下，在如下表中的条件，如此测试循环 5 次 <table border="1" data-bbox="472 1570 986 1776"> <tr> <td>Step.</td> <td>1</td> <td>2</td> <td>3</td> <td>4</td> </tr> <tr> <td>Temp. (°C)</td> <td>-55 +0 / -3</td> <td>25 +10 / -5</td> <td>85 +3 / -0</td> <td>25 +10 / -5</td> </tr> <tr> <td>Exposed time (min)</td> <td>30</td> <td>5</td> <td>30</td> <td>5</td> </tr> </table>	Step.	1	2	3	4	Temp. (°C)	-55 +0 / -3	25 +10 / -5	85 +3 / -0	25 +10 / -5	Exposed time (min)	30	5	30	5	1). Appearance shall not be distinct damage. 不能出现明显的外观损坏 2). Contact Resistance value After test: 90m Ω Maximum. 测试后电阻值: 90m Ω Maximum
Step.	1	2	3	4														
Temp. (°C)	-55 +0 / -3	25 +10 / -5	85 +3 / -0	25 +10 / -5														
Exposed time (min)	30	5	30	5														

BTB Pitch 0.4mm Series CONN

7.4.2	Humidity 耐湿性	EIA 364-31, Test Condition A Method III, (or MIL-202F, Method 103B Test Condition B.) The specimens shall be separated and left in the chamber of $40\pm 2^{\circ}\text{C}$ temperature and 90~95% humidity for 96hrs. After test drying in ambient condition for 1 hours 将测试样本公母端分离放在一个恒温恒湿的空间内暴露 96 小时，此空间温度： $40\pm 2^{\circ}\text{C}$ ，相对湿度：90~95%。测试完成后将样本擦干放置在周围环境中 1 小时	1). Appearance shall not be distinct damage. 不能出现明显的外观损坏 2). The Insulation Resistance value After test: $100\text{ M}\Omega$ Min 测试后绝缘阻抗值： $100\text{ M}\Omega$ Min
7.4.3	Solder ability 焊接性	EIA 364-52 Make the specimens' tail tested by the last testing step immersion into molten solder at $260\pm 5^{\circ}\text{C}$ for 5-10 seconds. 测试样本焊脚浸润在温度为 $260\pm 5^{\circ}\text{C}$ 的熔融态锡里面 5-10s。然后将样本拿出。	The surface of the portion to be soldered shall at least 95% covered area must show no voids, pin holes 要求焊脚润锡面积达到浸润面积的 95% 以上
7.4.4	Resistance to high storage temperature 高温存储测试	Make the samples be separated and Leave them in the chamber of temperature $+85^{\circ}\text{C}$ for 96hr, then it shall be subjected to standard atmospheric condition for 1~2h 将测试样本分离放置在一个 $+85^{\circ}\text{C}$ 的空间里暴露 96 小时，然后在标准环境下放置 1-2h.	1). Appearance shall not be distinct damage. 不能出现明显的外观损坏 2). Contact Resistance value After test: $90\text{ m}\Omega$ Maximum. 测试后电阻值： $90\text{ m}\Omega$ Maximum
7.4.5	resistance to low storage temperature 低温存储测试	Make the samples be separated and Leave them in the chamber of temperature -40°C for 96hr, then it shall be subjected to standard atmospheric condition for 1~2h 将测试样本分离放置在一个 -40°C 的空间里暴露 96 小时，然后在标准环境下放置 1-2h	1). Appearance shall not be distinct damage. 不能出现明显的外观损坏 2). Contact Resistance value After test: $90\text{ m}\Omega$ Maximum. 测试后电阻值： $90\text{ m}\Omega$ Maximum

BTB Pitch 0.4mm Series CONN

7.4.6	Salt water spray 盐雾测试	EIA 364-16A (MIL-STD-202 METHOD 101) Temperature: 35°C ± 2°C 温度: 35°C ± 2°C Density of salt water : 5 ± 1% 盐水浓度: 5 ± 1% Duration: 24 ± 4 hours. 持续时间: 24 ± 4 hours.	1). Appearance shall not be distinct damage. 不能出现明显的外观损坏 2). Contact Resistance value After test: 90m Ω Maximum. 测试后电阻值: 90m Ω Maximum
7.5 Others(其他测试)			
7.5.1	IR .Reflow 翘曲测试	Soak Zone :150°C~200°C Time:100~120s Reflow Zone > 217°C Time:100~150s Peak Temperature: 260 ± 5°C 30s Min The test to 2 cycles for each sample The IR reflow temp ref. to 5.0。 均温区: 150°C~200°C 时间: 100~120s 回流区: 大于 217°C 时间: 100~150s 峰值温度: 260 ± 5°C 30s Min 此测试样品需循环 2 次 冷却后测量产品的翘曲度 详细曲线(参考附图 5.0)	1). Shall meet visual requirement, show no physical damage. 外观没有任何的物理损坏 2). samples Without PCB after IR.Relow Coplanarity 0.10 mm Max 样品不含 PCB,IR Relow 后共面度 0.10 mm Max
7.5.2	Double sided PCB IR. Reflow testing 正反向 IR reflow 测试	Product soldering in PCB and Thru, IR Flow after cooling 30 minutes and opposite PCB make product down side thru。 The IR reflow temp ref. to 5.0。 Reflow soldering: Soak Zone :150°C~200°C Time:100~120s Reflow Zone > 217°C Time:100~150s Peak Temperature: 260 ± 5°C 30s Min 产品焊接 PCB 板, 经过 IR Reflow 后, 冷却 30 分钟, 再将 PCB 反向, 再过一遍 IR Reflow。 均温区: 150°C~200°C 时间: 100~120s 回流区: 大于 217°C 时间: 100~150s 峰值温度: 260 ± 5°C 30s Min 详细曲线(参考附图 1.0)	1). Shall meet visual requirement, show no physical damage. 外观没有任何的物理损坏 2).The product not allow dropping from PCB board by the second time of IR reflow test . 两次过炉后, 产品不能从 PCB 板掉落

INFRARED REFLOW CONDITION (回流焊曲线条件)

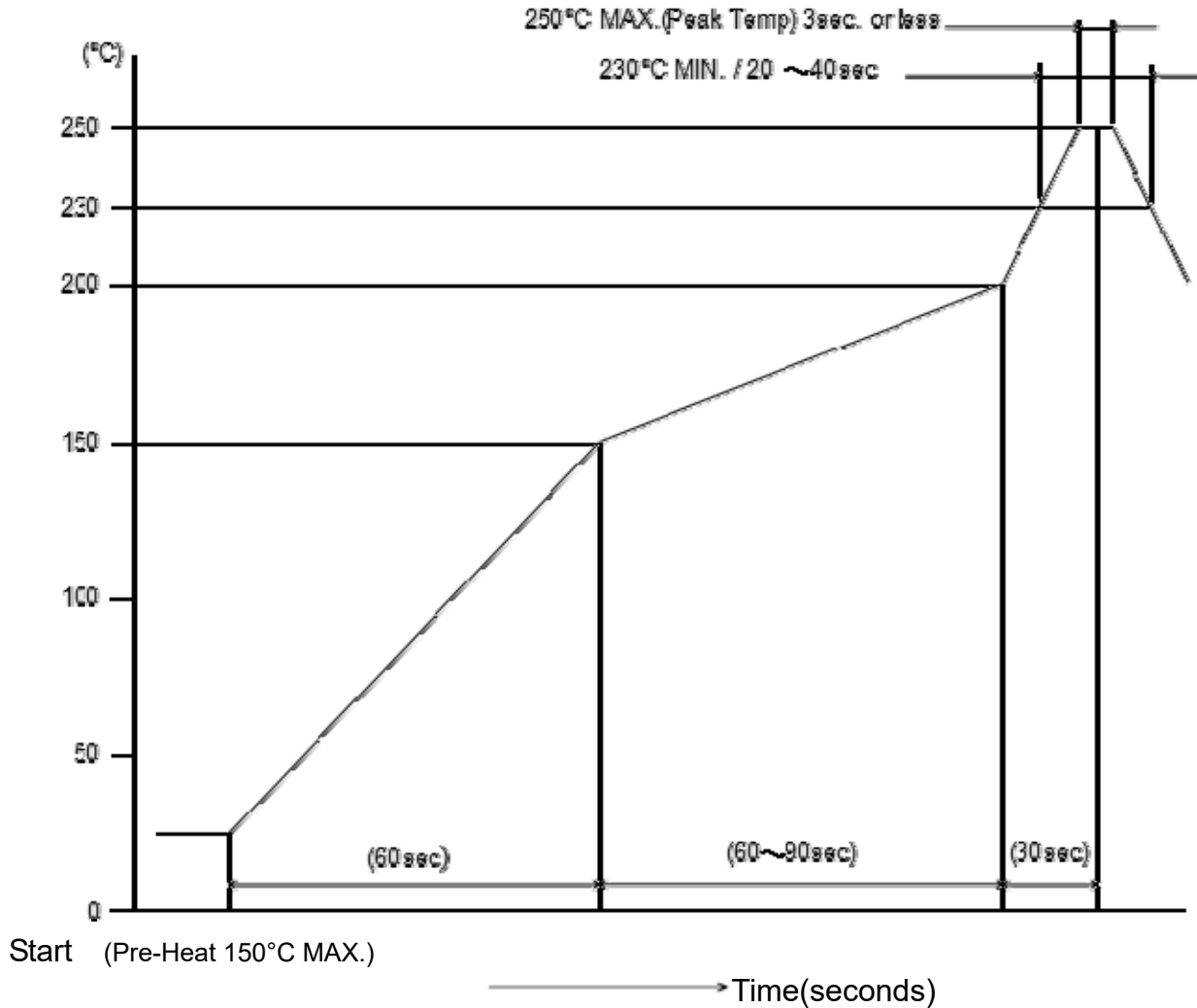

温度条件 TEMPERATURE CONDITION GRAPH
(基板表面温度) (TEMPERATURE ON BOARD PATTERN SIDE)

Fig1.Reflow Temperature profile

8.0 Group Tests (群组测试):

Test Group		Sample Groups											
Test Item	Test Description	A	B	C	D	E	F	G	H	I	J	K	
7.1.1	Examination of product	1,7	1,10	1,6	1,3	1,4	1,4	1,4	1,3	1,3	1,3	1,3	
7.2.1	Low Level Contact Resistance	2,6	2,9	2,5		3	3	3					
7.2.2	Insulation Resistance		3,7										
7.2.3	Dielectric Withstanding Voltage		4,8										
7.2.4	Temperature rise								2				
7.3.1	Vibration			3									
7.3.2	Physical shock			4									
7.3.3	Durability	4											
7.3.4	Mating & Unmating force	3,5											
7.3.5	Contact Retention Force									2			
7.4.1	Thermal Shock		5										
7.4.2	Humidity		6										
7.4.3	Solderability				2								
7.4.4	Heat resistance					2							
7.4.5	Cold resistance						2						
7.4.6	Salt water spray							2					
7.5.1	IR.Reflow Housing warp testing										2		
7.5.2	Two PCB side IR. Reflow testing											2	
Number of Test Samples (Minimum)		5	5	5	5	5	5	5	5	5	5	5	

9.0 INSTRUCTION OF APPLICATION TO USAGE 产品组装的使用说明

This specification is written based on the supposition that the receptacle is mounted on PCB (Hard PCB) and the plug is mounted on FPC. In the case of the receptacle is mounted on FPC and the plug is mounted on PCB (Hard PCB) is also covered. Receptacle contains formable terminal. Please pay attention to un-mating process of connectors if you mount Receptacle on FPC

本说明书根据母座端往PCB基板（硬板）侧实际安装、公座端往FPC（软板）侧，实际安装的设想而作成，同时也适用于公座端往FPC（软板）、公座往PCB基板（硬板）上的实装。母座上的端子容易变形，实装到FPC（软板）上时，特别要注意拔出时的操作。

9.1 MATING (插入操作相关)

9.1.1 HOW TO MATE(INsertION) 组合方法（插入方法）

After positioning correctly for mating ,then the distance between PCB and FPC is about 1.30mm, insert the Plug to the receptacle in parallel with each other.

组合时（插入时）请对好位置再进行。位置对好时，PCB基板和FPC软板间的尺寸大概位置在1.30mm之后，请将公座侧与母座侧保持平衡后再插入

Please find correct position at inside wall of receptacle and inside wall of plug

正确的位置调合如右图，请沿母座内壁和公座内壁来进行操作

STEP 1

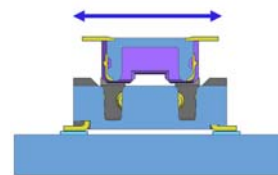
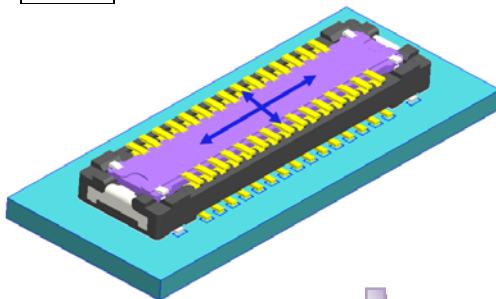

Positioning the plug correctly in parallel with the receptacle
请在公座侧与母座侧保持平衡的状态下再校对位置

STEP 2

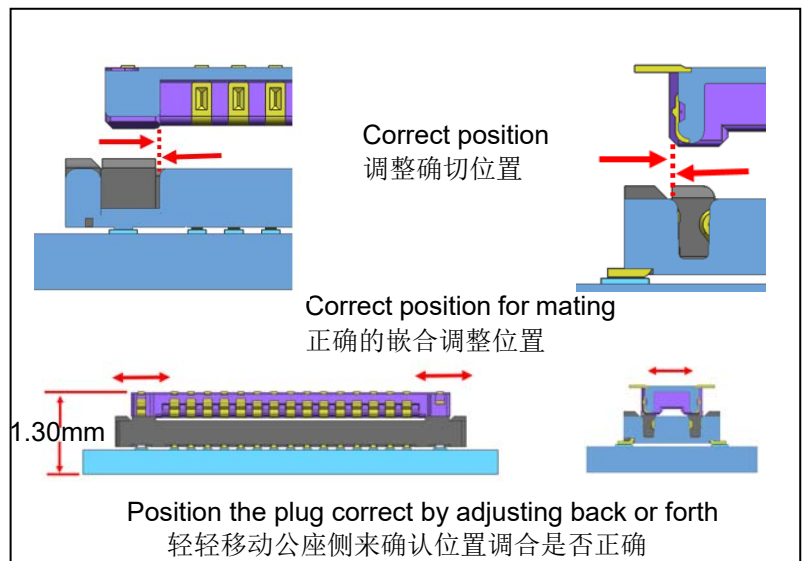
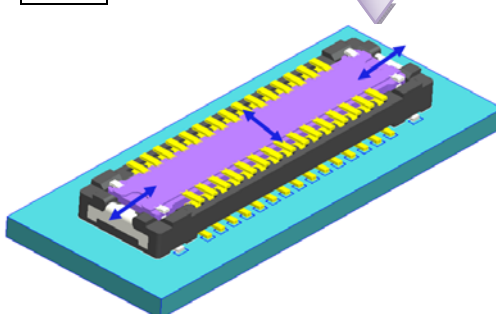

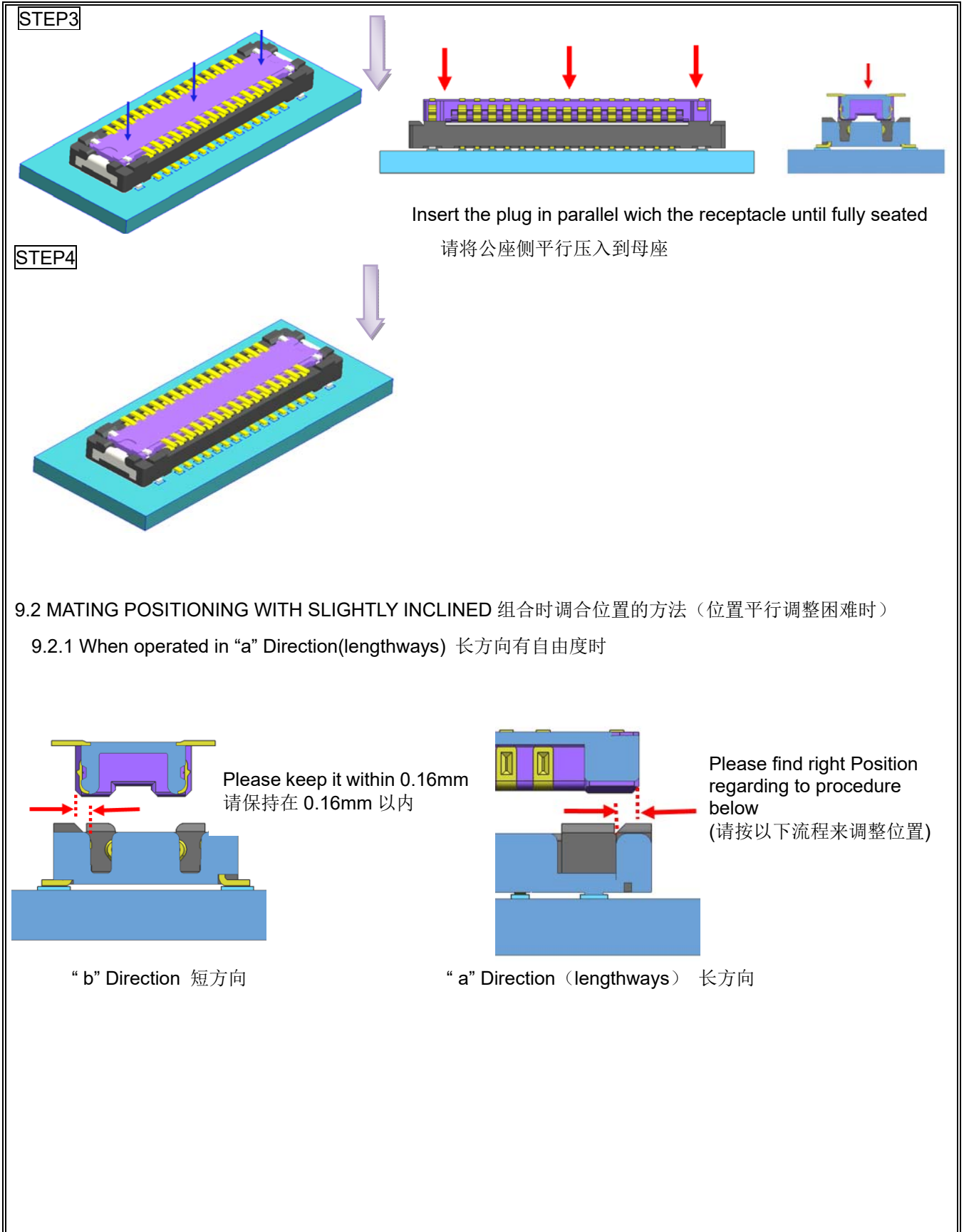

STEP1

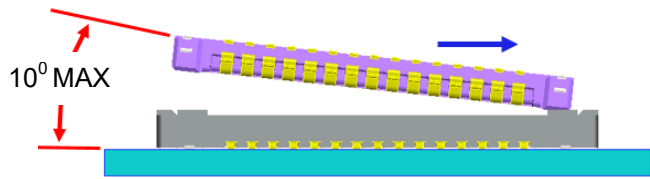
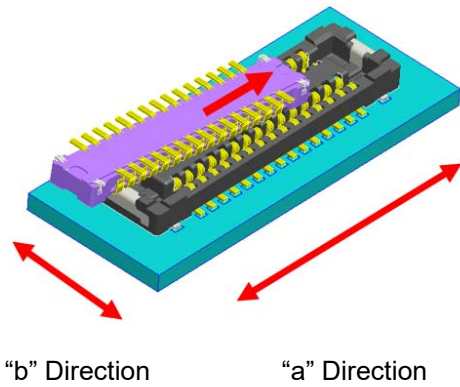

Position for mating by inclining the plug to the receptacle approximately less than 10°
请在公座侧稍微倾斜（10度以下）的状态下进行组合位置调整操作

STEP2

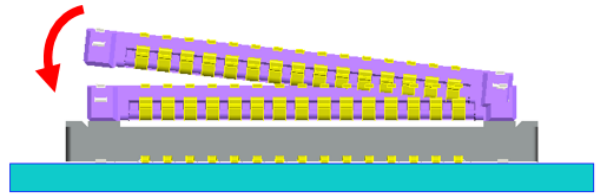
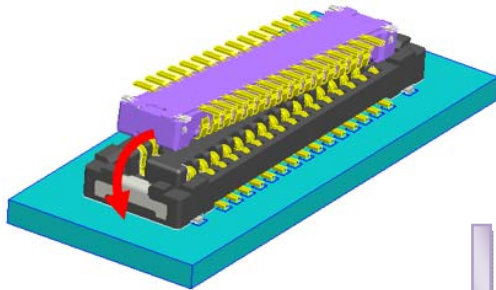

Once the plug is positioned over the receptacle
Move it to the parallel position
位置调合后，请将公座侧和母座侧保持平行

STEP3

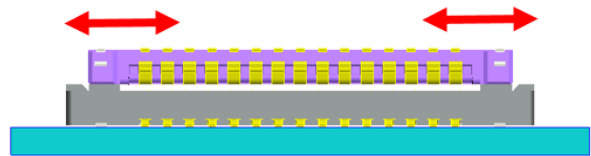
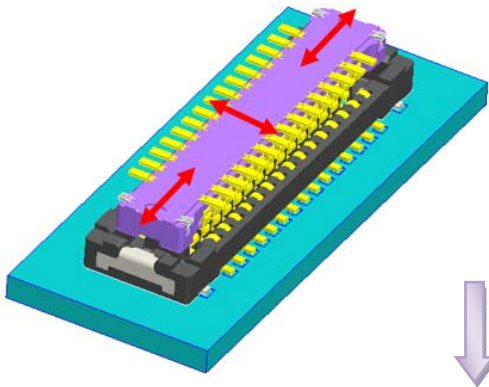

Position the plug correct by adjusting back or forth
轻轻移动公座侧来确认位置调合是否对位

Please go to the STEP3 in 9.1.1
请参照 9.1.1 步骤 3 进行下一步操作

9.2.2 When operated in "b" Direction 短方向有自由度时

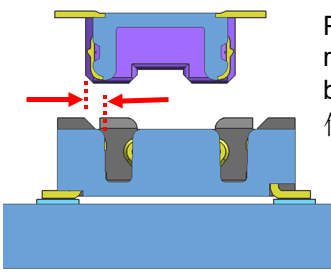

Please find right Position regarding to procedure below(请按以下流程来调整位置)

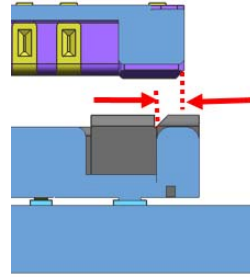

Please keep it within 0.25mm 请保持在 0.25mm 以内

"b" Direction 短方向

"a" Direction (lengthways) 长方向

STEP1

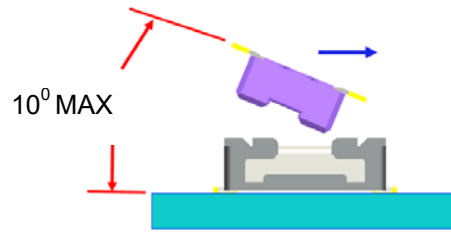
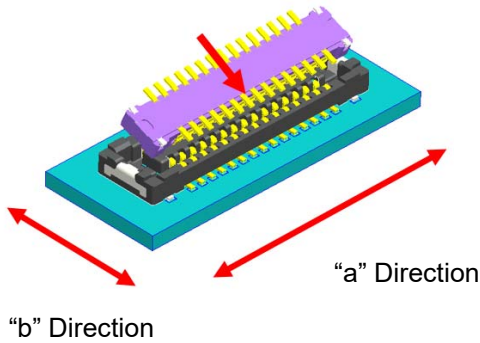

Position for mating by inclining the plug to the receptacle approximately less than 10° 请在公座侧稍微倾斜（10度以下）的状态下进行组合位置调整操作

STEP2

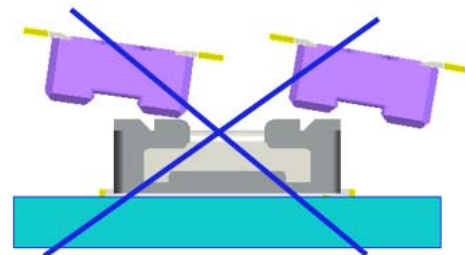
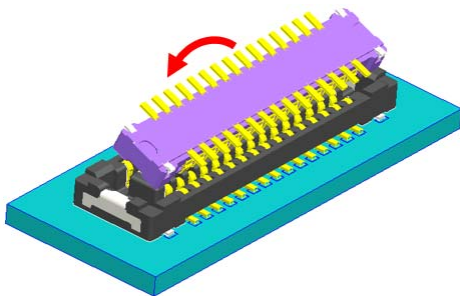

Notes)Pay attention NOT to have the wrong position in "b" Direction 注：请注意位置调合偏差不能太大

STEP3

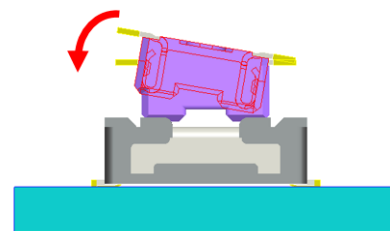
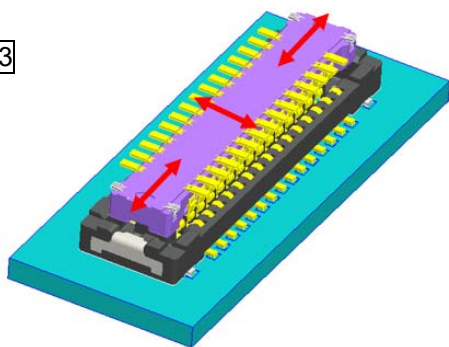

Once the plug is positioned over the receptacle Move it to the parallel position 位置调合后，请将公座侧和母座侧保持平行 Position the plug correct by adjusting back or forth 轻轻移动公座侧来确认位置调合是否对位

Please go to the STEP3 in 9.1.1 请参照 9.1.1 步骤 3 进行下一步操作

9.3 CONNECTOR HANDLING WHEN MATING(组合时操作注意事项)

Please DO NOT apply force while mating the receptacle or plug at an angle in the "a" direction(lengthways)

It may cause damage to the connector

请在连接器之间平行的状态下进行组合操作。如果在连接器之间不平行、处在倾斜的状态下组合时，连接器本体之间可能会有干涉，就会有损坏连接器的可能。

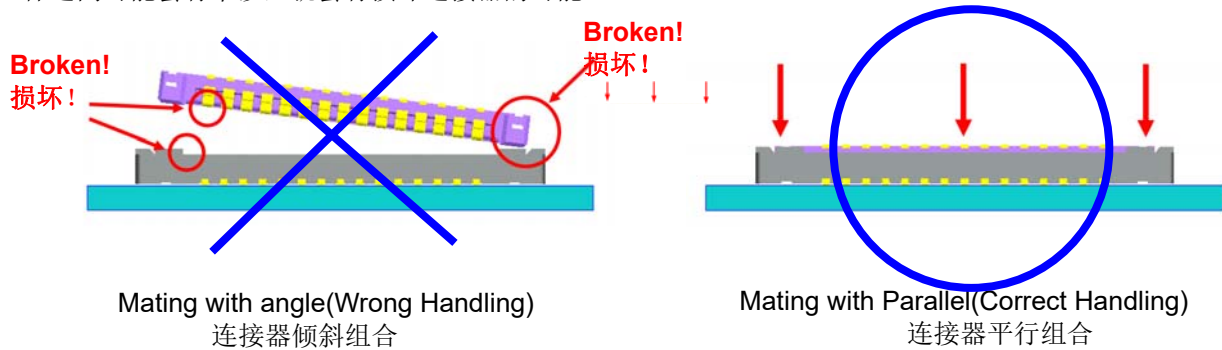

This product is downsized comparing with the current products and needs to be handled more carefully.

When mating(inserting), do NOT push the only center of connector but the whole connector in parallel with

The receptacle . When pushed only the center of connector , it may cause damage to the connector

本产品比现有产品还要小，连接器的强度较低。组合（插入）时，不能单单只按压连接器中间部，要平行按压整体。FPC 加强板的强度不充足时，如果只按压连接器中间的话，连接器就会有折断的可能。

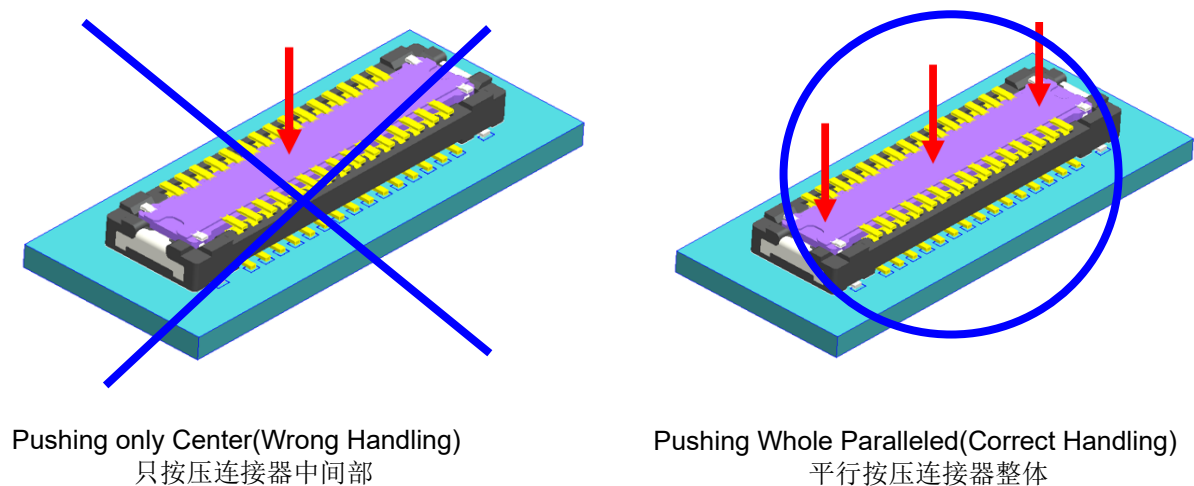

9.4 UN-MATING

9.4.1 HOW TO WITHDRAW 拔出方法

The plug shall be released from the receptacle paralleled to the mated axis or by moving the plug slowly 极力沿着组合轴平行拔去，或是向左右一点点边晃动边拔出。

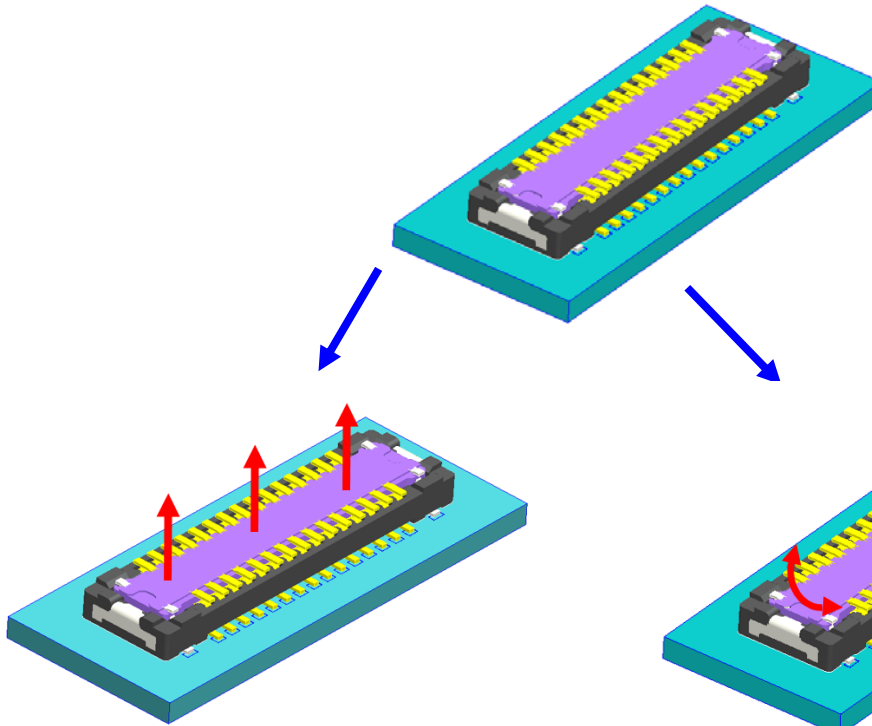

Releasing the plug paralleled to the mated axis
沿着组合轴向平行拔去

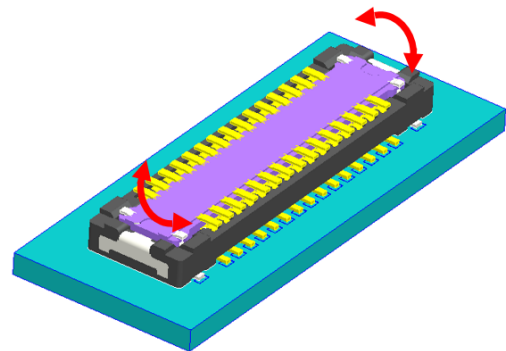

Releasing the plug by moving slowly in "a" direction
(lengthways) 向左右一点点边晃动边拔去 (长方向)

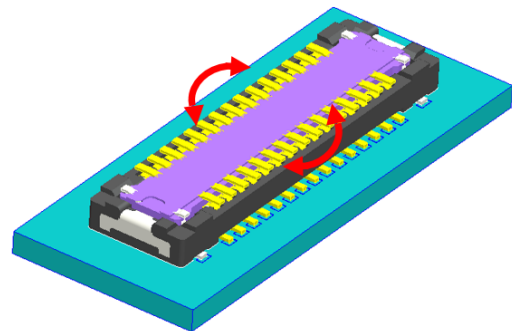

Releasing the plug by moving slowly in "b" direction
向左右一点点边晃动边拔去(短方向)

9.4.2 CONNECTOR HANDLING WHEN WITHDRAWING (拔出时操作注意事项)

This product is downsized comparing with the current products and needs to be handled more carefully

When un-mating(withdrawing), do NOT twist the plug to release . It may cause damage to connector.

本产品比现有产品还要小，连接器的单体强度较低（单体强度）。如果在过度倾斜状态下拔去的话，连接器就会有破损的可能

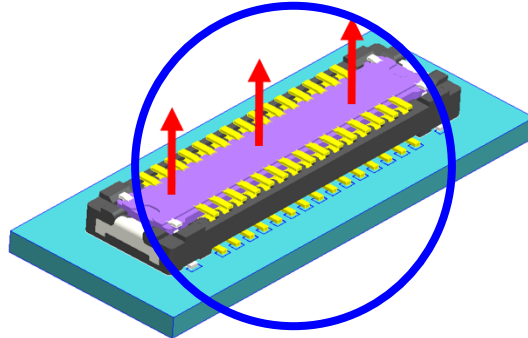

Releasing the plug paralleled to the mated axis
沿着组合轴向平行拔去

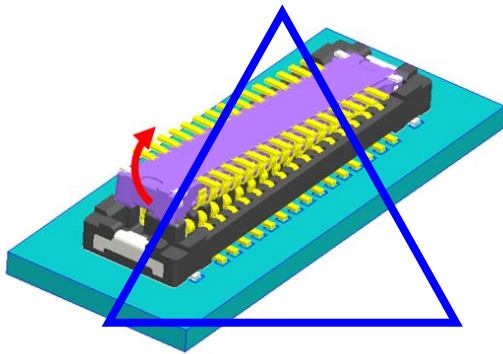

Slant releasing in "a" Direction (lengthways)
长方向的倾斜拔出

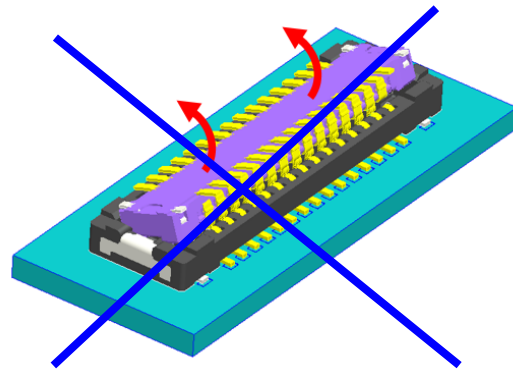

Slant releasing in "b" Direction
短方向的倾斜拔出

Merit and demerit for slant releasing are below

长方向的倾斜拔去方式与短方向的倾斜拔去方式存在以下优点及缺点

	Slant releasing in "a" Direction (lengthways) 长方向的倾斜拔出	Slant releasing in "b" Direction 短方向的倾斜拔出
Merit 优点	1.Not easily cause the damage to the terminals 不容易引起端子变形 2.Hard to be withdrawn 拔出的力度小	None 无特别优点
Demerit 缺点	Multiple connector can be damaged plug 多个连接器时拔出时可能会损坏公座	The continuity defect can be caused by damage to the terminals 端子变形风险，同时会存在不导通的可能

HF

REV.	ECO NO.	DATE	SIGN	DESCRIPTION
A	/	2019.3.20	JACK LIU	INITIAL RELEASE

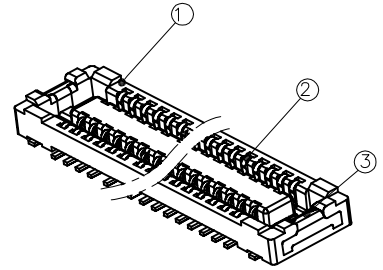
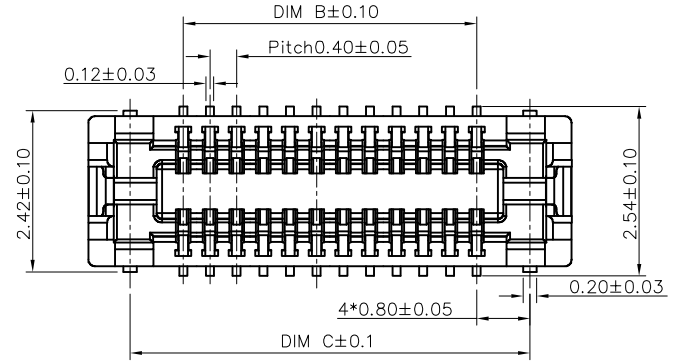

NOTES:
 1. FINISH:
 1-1 CONTACT: G/F PLATING ON CONTACT AREA AND SOLDER TAILS NICKEL UNDERPLATING OVER ALL
 1-2 SHELL: G/F PLATING ON SOLDER TAILS NICKEL UNDERPLATING OVER ALL
 2. PRODUCT SPECIFICATION:
 2-1 OPERATING TEMPERATURE: -55°C~+85°C
 2-2 DURABILITY: 30 cycles.
 2-3 CURRENT RATING: 0.3A/PIN
 2-4 VOLTAGE RATING: 60V AC/DC

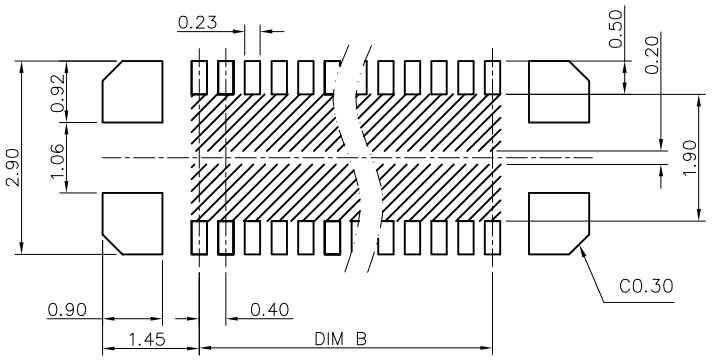
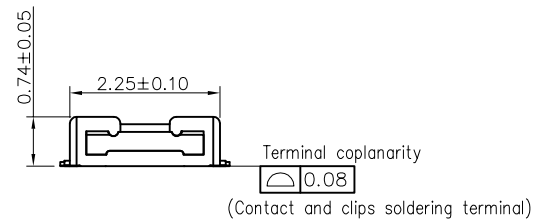
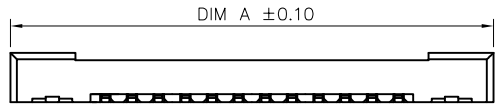

RECOMMENDED PCB LAYOUT(NO PATTERNS)
(TOLERANCE: ±0.03)

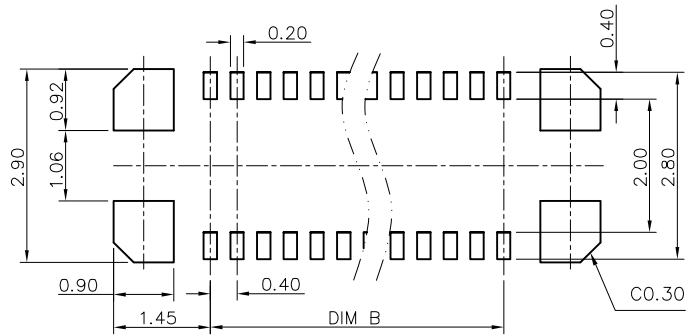

RECOMMENDED METAL MASK LAYOUT(NO PATTERNS) t=0.08mm
(TOLERANCE: ±0.01)

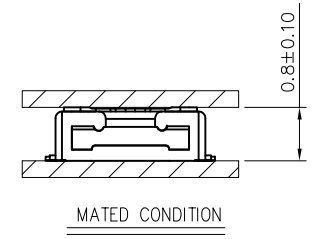

Part Number	A	B	C
SS2564010F	4.45	1.60	3.20
SS2564024F	7.25	4.40	6.00
SS2564030F	8.45	5.60	7.20
SS2564040F	10.45	7.60	9.20
SS2564050F	12.45	9.60	11.20
SS2564060F	14.45	11.60	13.20

NO.	DESCRIPTION	MATERIAL	COLOR	REMARK
3	GND Terminal	COPPER ALLOY	—	AU PLATING
2	CONTACT	COPPER ALLOY	—	AU PLATING
1	HOUSING	LCP	BLACK	

TOLERANCE UNLESS SPECIFIED	SHEET 1/3	DR. BY	JACK	MATERIAL	
LINEAR		CHK. BY	wilson	FINISH	
ANGLE		APP. BY	WX.L	PART NO.	
X ±0.25 X* XX	SCALE				
XX ±0.15 .X* XX	UNIT mm				
XXX ±0.10 .XX* XX					

深圳市盛世台圳科技有限公司	
TITLE	BTB P.O.4mm REC CONN
DWG NO.	SS526F

HF

REV.	ECO NO.	DATE	SIGN	DESCRIPTION
A	/	2019.3.20	JACK LIU	INITIAL RELEASE

EMBOSSED TAPE PACKAGING

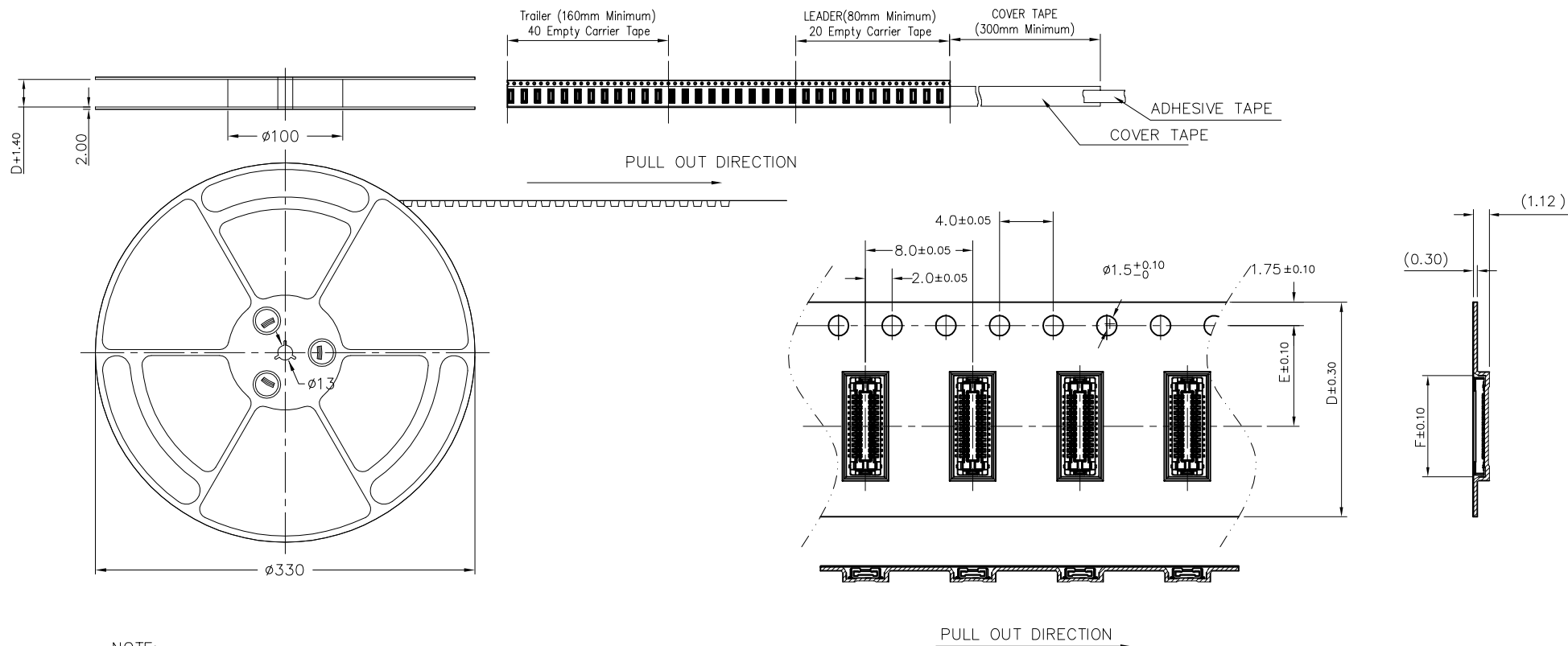

NOTE:

- 1.10 SPROCKET HOLE PITCH CUMULATIVE TOLERANCE ± 0.2 mm
- 2.CARRIER CAMBER IS WITHIN 1 mm IN 250mm.
- 3.MATERIAL : TRANSPARENT CONDUCTIVE POLYSTYRENE ALLOY.
- 4.THICKNESS : 0.3 ± 0.05 mm.
- 5.COMPONENT LOAD PER 13'' REEL : 5000 PCS

PART NUMBER	DIM. D	DIM. E	DIM. F
SS2564010F	16	7.5	4.75
SS2564024F	16	7.5	7.55
SS2564030F	16	7.5	8.75
SS2564040F	24	11.5	10.75
SS2564050F	24	11.5	12.75
SS2564060F	24	11.5	14.75

TOLERANCE UNLESS SPECIFIED		SHEET 2/3	DR. BY	JACK	MATERIAL
LINEAR	ANGLE	SCALE	CHK. BY	wilson	FINISH
X ± 0.25 X' XX		UNIT mm	APP. BY	WX.L	PART NO.
XX ± 0.15 .X' XX					
XXX ± 0.10 .XX' XX					

深圳市盛世台圳科技有限公司	
TITLE	BTB P0.4mm REC CONN
DWG NO.	SS256F

HF

REV.	ECO NO.	DATE	SIGN	DESCRIPTION
A	/	2019.3.20	JACK LIU	INITIAL RELEASE

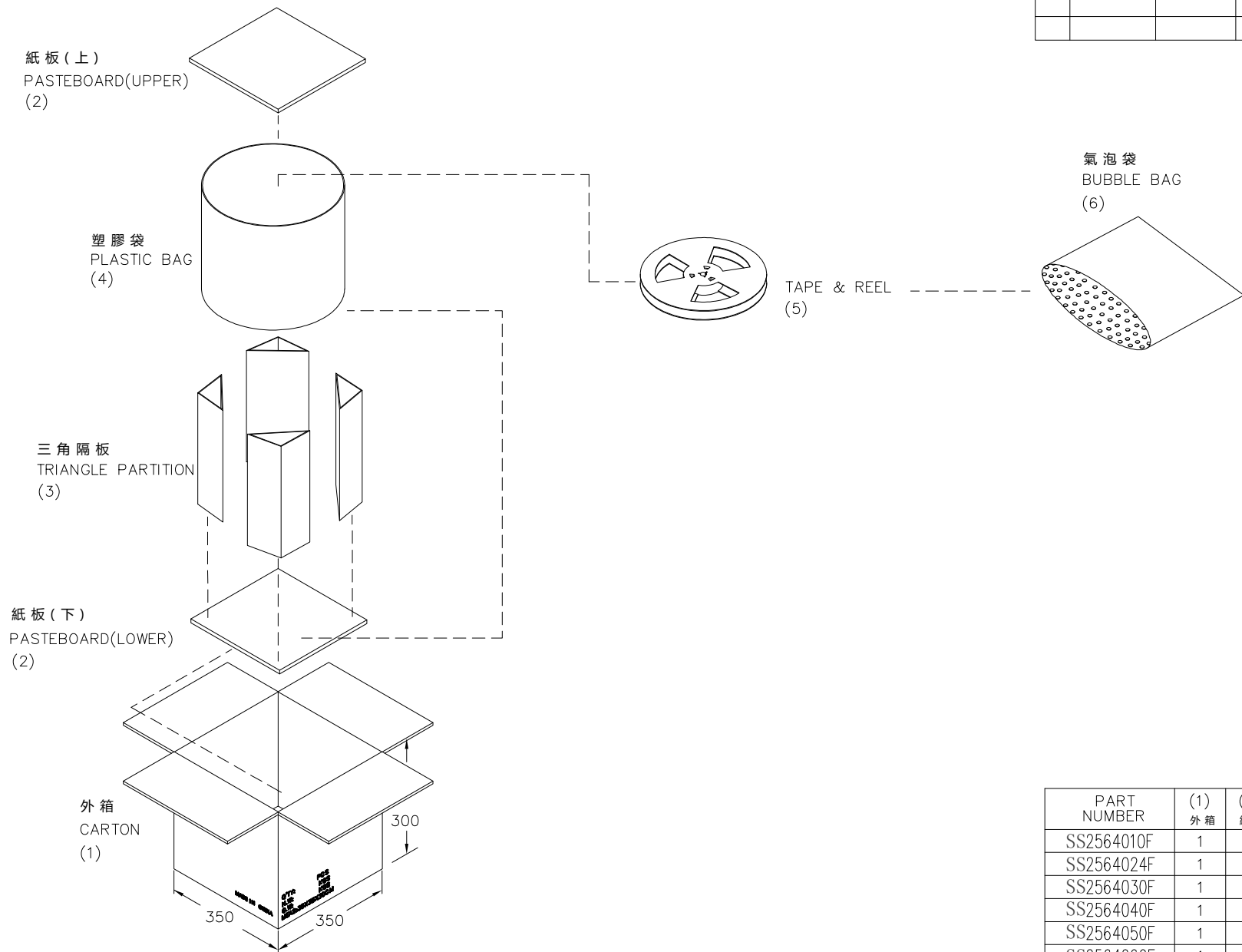

PART NUMBER	(1) 外箱	(2) 紙板	(3) 三角隔板	(4) 塑膠袋	(5) 膠帶	(6) 氣泡袋
SS2564010F	1	2	4	1	10	10
SS2564024F	1	2	4	1	10	10
SS2564030F	1	2	4	1	10	10
SS2564040F	1	2	4	1	8	8
SS2564050F	1	2	4	1	8	8
SS2564060F	1	2	4	1	8	8

TOLERANCE UNLESS SPECIFIED		SHEET 3/3	DR. BY	JACK	MATERIAL
LINEAR	ANGLE	SCALE	CHK. BY	wilson	FINISH
X ±0.25	X° XX	UNIT mm	APP. BY	WX.L	PART NO.
XX ±0.15	.X° XX				
XXX ±0.10	.XX° XX				

深圳市盛世台圳科技有限公司

TITLE	BTB P0.4mm REC CONN
DWG NO.	SS526F

HF

REV.	ECO NO.	DATE	SIGN	DESCRIPTION
A	/	2019.3.20	JACK LIU	INITIAL RELEASE

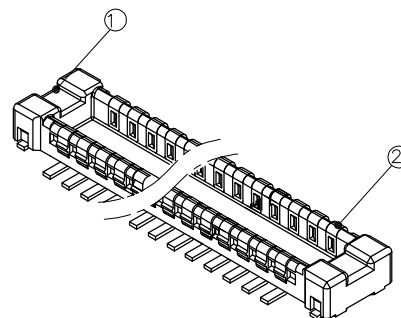
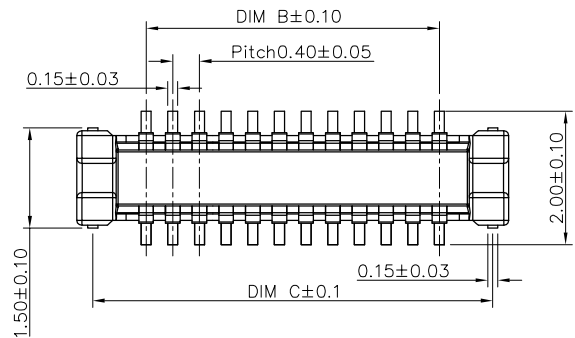

NOTES:
 1. FINISH:
 1-1 CONTACT: G/F PLATING ON CONTACT AREA AND SOLDER TAILS NICKEL UNDERPLATING OVER ALL
 1-2 SHELL: G/F PLATING ON SOLDER TAILS NICKEL UNDERPLATING OVER ALL
 2. PRODUCT SPECIFICATION:
 2-1 OPERATING TEMPERATURE: -55°C~+85°C
 2-2 DURABILITY: 30 cycles.
 2-3 CURRENT RATING: 0.3A/PIN
 2-4 VOLTAGE RATING: 60V AC/DC

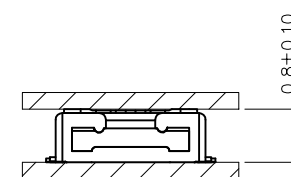
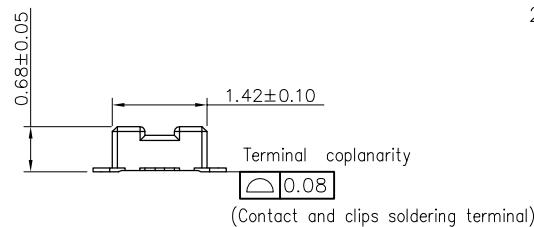
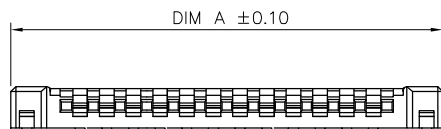

MATED CONDITION

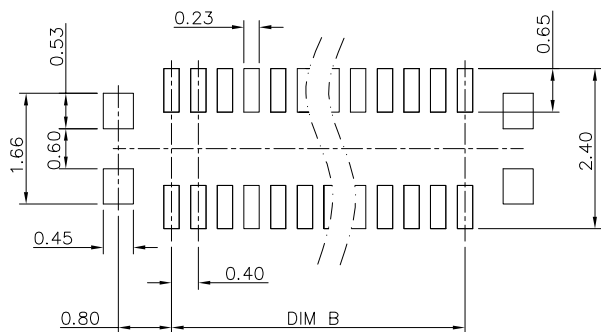

RECOMMENDED PCB LAYOUT(NO PATTERNS)
(TOLERANCE: ±0.03)

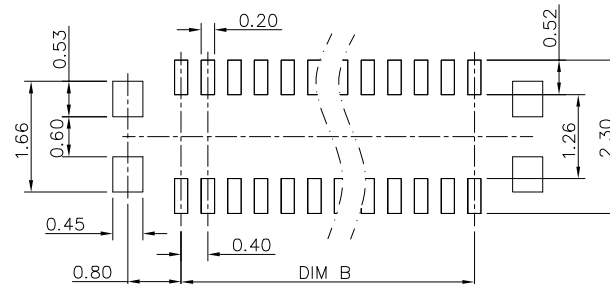

RECOMMENDED METAL MASK LAYOUT(NO PATTERNS) t=0.08mm
(TOLERANCE: ±0.01)

2	CONTACT	COPPER ALLOY	—	AU PLATING	SS2564010M	3.68	1.60	3.20
1	HOUSING	LCP	BLACK		SS2564024M	6.48	4.40	6.00
					SS2564030M	7.68	5.60	7.20
					SS2564040M	9.68	7.60	9.20
					SS2564050M	11.68	9.60	11.20
					SS2564060M	13.68	11.60	13.20

TOLERANCE UNLESS SPECIFIED		SHEET 1/3	DR. BY	JACK	MATERIAL
LINEAR	ANGLE	SCALE	CHK. BY	wilson	FINISH
X ±0.25	X° XX	UNIT mm	APP. BY	WX.L	PART NO.
XX ±0.15	.X° XX				
XXX ±0.10	.XX° XX				

深圳市盛世台圳科技有限公司

TITLE	BTB P0.4mm PLUG CONN
DWG NO.	SS526M

HF

REV.	ECO NO.	DATE	SIGN	DESCRIPTION
A	/	2019.3.20	JACK LIU	INITIAL RELEASE

EMBOSSED TAPE PACKAGING

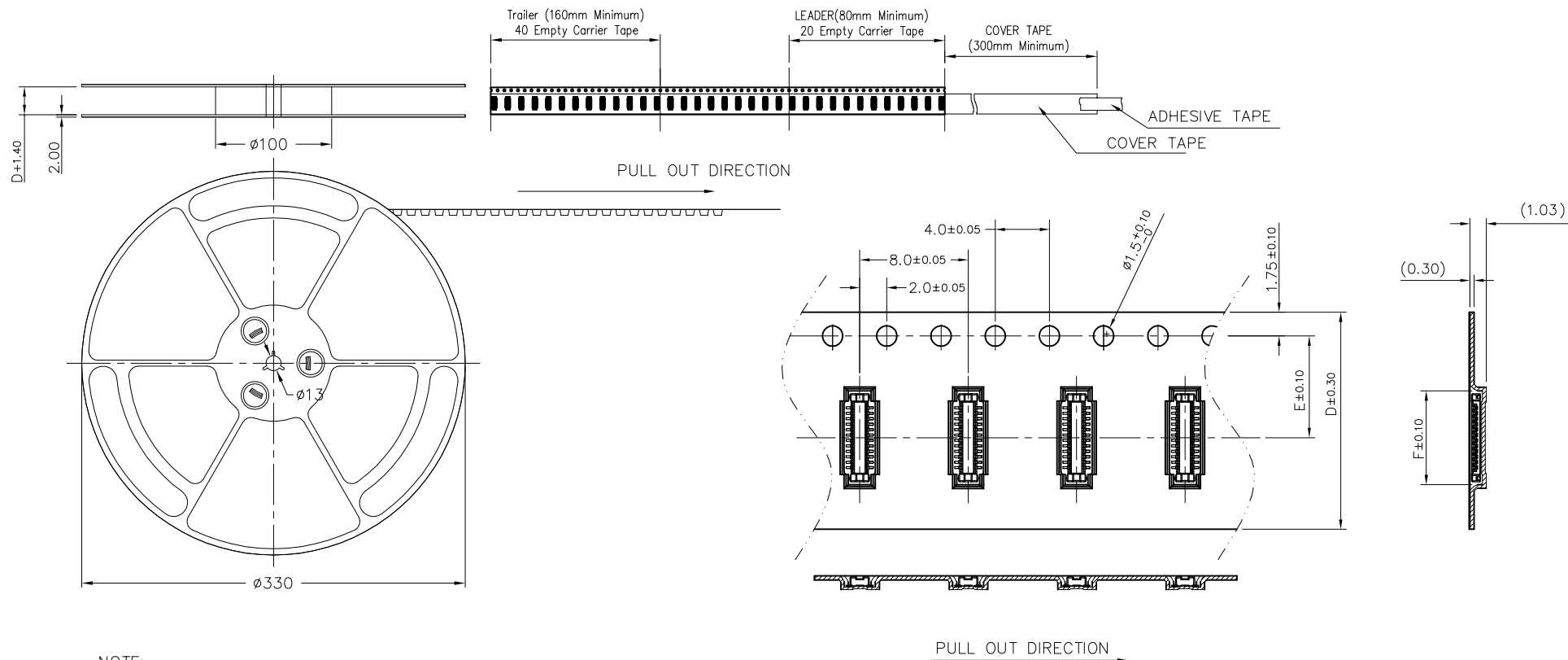

NOTE:

- 1.10 SPROCKET HOLE PITCH CUMULATIVE TOLERANCE $\pm 0.2\text{mm}$
- 2.CARRIER CAMBER IS WITHIN 1 mm IN 250mm.
- 3.MATERIAL : TRANSPARENT CONDUCTIVE POLYSTYRENE ALLOY.
- 4.THICKNESS : $0.3 \pm 0.05\text{mm}$.
- 5.COMPONENT LOAD PER 13'' REEL : 5000 PCS

PART NUMBER	DIM. D	DIM. E	DIM. F
SS2564010M	16	7.5	4.1
SS2564024M	16	7.5	6.9
SS2564030M	16	7.5	8.1
SS2564040M	24	11.5	10.1
SS2564050M	24	11.5	12.1
SS2564060M	24	11.5	14.1

TOLERANCE UNLESS SPECIFIED		SHEET 2/3	DR. BY	JACK	MATERIAL
LINEAR	ANGLE	SCALE	CHK. BY	wilson	FINISH
X ± 0.25 X' XX		UNIT mm	APP. BY	WX.L	PART NO.
XX ± 0.15 .X' XX					
XXX ± 0.10 .XX' XX					

深圳市盛世台圳科技有限公司

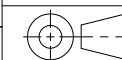

TITLE	BTB P0.4mm PLUG CONN
DWG NO.	SS526M

HF

REV.	ECO NO.	DATE	SIGN	DESCRIPTION
A	/	2019.3.20	JACK LIU	INITIAL RELEASE

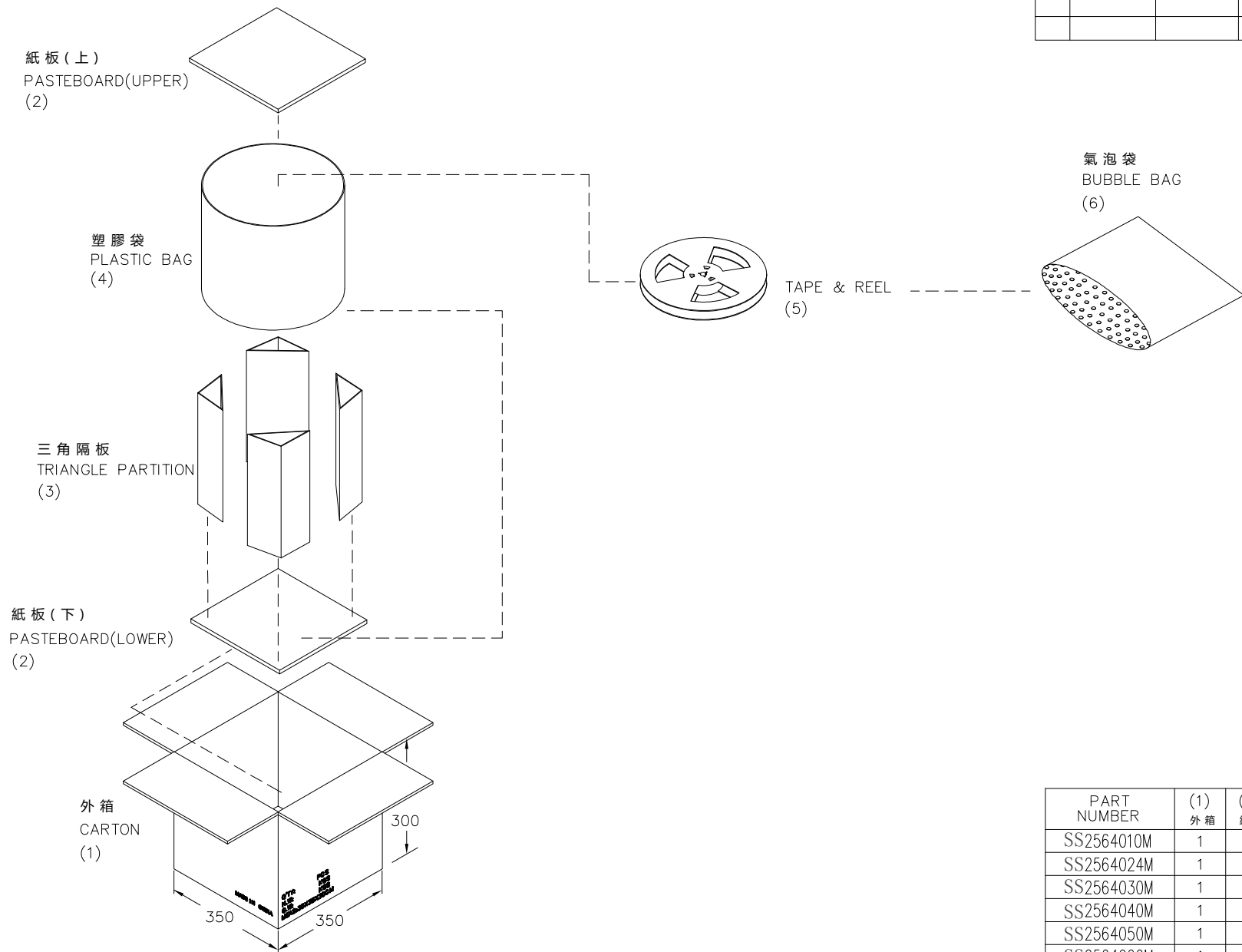

PART NUMBER	(1) 外箱	(2) 紙板	(3) 三角隔板	(4) 塑膠袋	(5) 膠帶	(6) 氣泡袋
SS2564010M	1	2	4	1	10	10
SS2564024M	1	2	4	1	10	10
SS2564030M	1	2	4	1	10	10
SS2564040M	1	2	4	1	8	8
SS2564050M	1	2	4	1	8	8
SS2564060M	1	2	4	1	8	8

TOLERANCE UNLESS SPECIFIED		SHEET 3/3	DR. BY	JACK	MATERIAL
LINEAR	ANGLE	SCALE	CHK. BY	wilson	FINISH
X ±0.25	X° XX	UNIT mm	APP. BY	WX.L	PART NO.
XX ±0.15	.X° XX				
XXX±0.10	.XX° XX				

深圳市盛世台圳科技有限公司

TITLE	BTB P0.4mm PLUG CONN
DWG NO.	SS526M