

SPECIFICATIONS

Customer	
Product Name	Wire Wound SMD Power Inductor
Sunlord Part Number	WPN252012H220MT
Customer Part Number	

New Released, Revised]

SPEC No.: **WPN11200004**

【This SPEC is total 12 pages.】

【ROHS, Halogen-Free and SVHC Compliant Parts】

Approved By	Checked By	Issued By
		

Shenzhen Sunlord Electronics Co., Ltd.

Address: Sunlord Industrial Park, Dafuyuan Industrial Zone, Baoan, Shenzhen, China 518110
 Tel: 0086-755-29832660 Fax: 0086-755-82269029 E-Mail: sunlord@sunlordinc.com

【For Customer approval Only】

Date: _____

Qualification Status: Full Restricted Rejected

Approved By	Verified By	Re-checked By	Checked By

Comments:

Caution

All products listed in this specification are developed, designed and intended for use in general electronics equipment. The products are not designed or warranted to meet the requirements of the applications listed below, whose performance and/or quality require especially high reliability, or whose failure, malfunction or trouble might directly cause damage to society, person, or property. Please understand that we are not responsible for any damage or liability caused by use of the products in any of the applications below. Please contact us for more details if you intend to use our products in the following applications.

1. Aircraft equipment
2. Aerospace equipment
3. Undersea equipment
4. nuclear control equipment
5. military equipment
6. Power plant equipment
7. Medical equipment
8. Transportation equipment (automobiles, trains, ships, etc.)
9. Traffic signal equipment
10. Disaster prevention / crime prevention equipment
11. Data-processing equipment
12. Applications of similar complexity or with reliability requirements comparable to the applications listed in the above

【Version change history】

Rev.	Effective Date	Changed Contents	Change Reasons	Approved By
01	Mar.27,2020	New released	/	Qintian Hou

1 Scope

This specification applies to the WPN252012H220MT of wire wound SMD power inductor.

2 Product Description and Identification (Part Number)

1) Description:

WPN252012H220MT of Wire wound SMD power inductor.

2) Product Identification (Part Number)

WPN 252012 H 220 M T
 ① ② ③ ④ ⑤ ⑥

① Type	
WPN	Wire wound SMD power inductor

② External Dimensions(LxWxH) [mm]	
252012	2.5X2.0X 1.2

③ Feature type	
H	High Type Material

④ Nominal Inductance	
Example	Example
220	22uH

⑤ Inductance Tolerance	
M	±20%

⑥ Packing	
T	Tape Carrier Package

3 Shape and Dimensions

Dimensions and recommended PCB pattern for reflow soldering, please see Fig.3-1, Fig. 3-2 and Table 3-1.

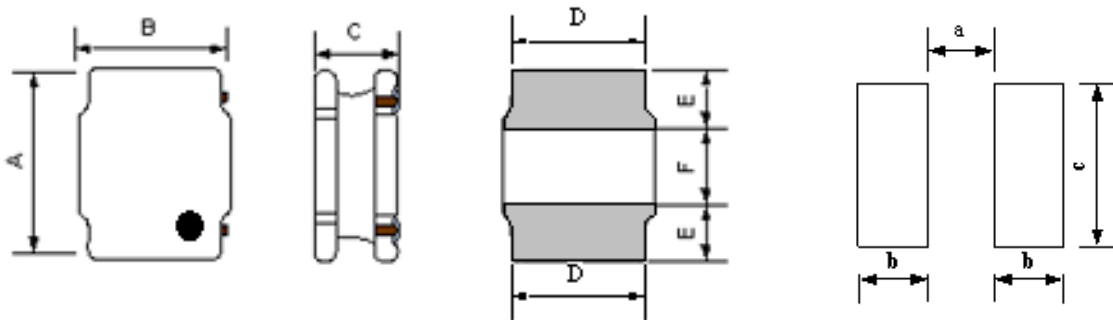

Fig.3-1,

[Table 3-1] (Unit: mm)

Series	A	B	C Max	D	E	F	a Typ	b Typ	c Typ
WPN252012H	2.5±0.2	2.0±0.2	1.2	1.65±0.2	0.8±0.2	0.8±0.2	0.80	0.85	2.0

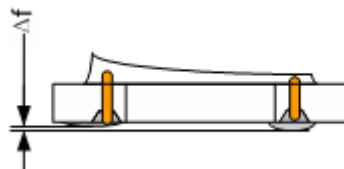

Fig.3-2

Δf: Clearance between terminal and the surface of plate must be 0.1mm max when coil is placed on a flat plate.

4 Electrical Characteristics

Please refer to Item 6

- Operating and storage temperature range (individual chip without packing): -40°C ~ +125°C (Including Self-heating).
- Storage temperature range (packaging conditions): -10°C ~ +40°C and RH 70% (Max.)

5 Test and Measurement Procedures

5.1 Test Conditions

5.1.1 Unless otherwise specified, the standard atmospheric conditions for measurement/test as:

- Ambient Temperature: 20±15°C
- Relative Humidity: 65±20%
- Air Pressure: 86kPa to 106kPa

5.1.2 If any doubt on the results, measurements/tests should be made within the following limits:

- a. Ambient Temperature: $20 \pm 2^\circ\text{C}$
- b. Relative Humidity: $65 \pm 5\%$
- c. Air Pressure: 86kPa to 106kPa

5.2 Visual Examination

Inspection Equipment: 10X microscope

5.3 Electrical Test

5.3.1 Inductance (L)

- a. Refer to **Item 6**. Test equipment: WK3260B LCR meter or equivalent.
- b. Test Frequency and Voltage: refers to **Item 6**.

5.3.2 Direct Current Resistance (DCR)

- a. Refer to **Item 6**.
- b. Test equipment: HIOKI 3540 or equivalent.

5.3.3 Saturation Current (Isat)

- a. Refer to **Item 6**.
- b. Test equipment: WK3260B LCR meter or equivalent.

5.3.4 Temperature rise current (I_{rms})

- a. Refer to **Item 6**.
- b. Test equipment (**see Fig. 5.3.4-1, Fig. 5.3.4-2**): Electric Power, Electric current meter, Thermometer.
- c. Measurement method
 1. Set test current to be 0 mA.
 2. Measure initial temperature of choke surface.
 3. Gradually increase current and measure choke temperature for corresponding current.
 4. Definition of Temperature rise current: DC current that causes the temperature rise (ΔT) from ambient temperature.

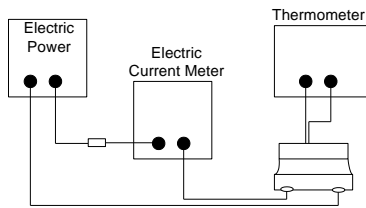

Fig. 5.3.4-1

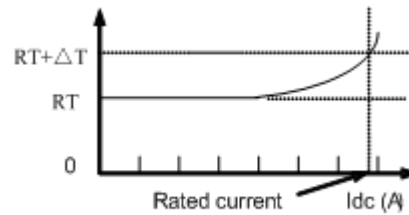

Fig. 5.3.4-2

5.3.5 Self-resonant frequency(SRF)

- a. Refer to **Item 6**.
- b. Test equipment: Agilent E4991A+16197 or equivalent

6 Electrical Characteristics

Customer P/N	Part Number	Inductance	Min. Self-resonant frequency	DC Resistance		Saturation Current		Heat Rating Current		Marking
		@1MHz		Max.	Typ.	Max.	Typ.	Max.	Typ.	
	Units	μH	MHz	Ω	Ω	A	A	A	A	
	Symbol	L	SRF	DCR		Isat		Irms		-
	WPN252012H220MT	22±20%	8.5	1.200	1.000	0.70	0.80	0.58	0.65	●

Note:※1 : Rated current: Isat (max.) or Irms (max.), whichever is smaller;

※2 : Saturation Current: Max. Value, DC current at which the inductance drops less than 30% from its value without current; Typ. Value, DC current at which the inductance drops 30% from its value without current;

※3 : Irms: DC current that causes the temperature rise (ΔT) from 20°C ambient.

For Max. Value, ΔT<40°C; for Typ. Value, ΔT is approximate 40°C.

The part temperature (ambient + temp. rise) should not exceed 125 °C under worst case operating conditions. Circuit design, component placement, PCB trace size and thickness, airflow and other cooling provisions all affect the part temperature. Part temperature should be verified in the end application.

※4 : Absolute maximum voltage: DC 25V

Typical Electrical Characteristics:

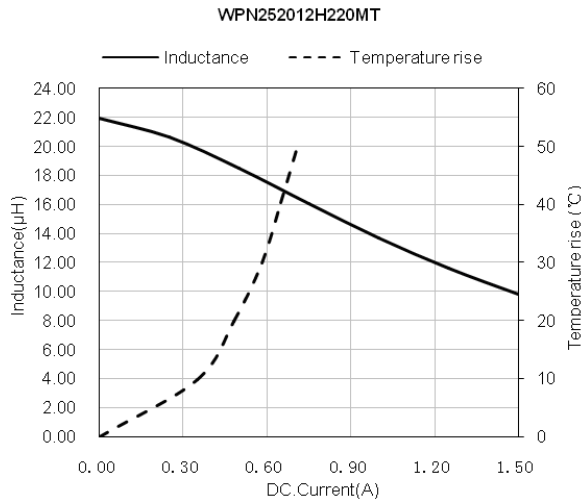

7 Structure

The structure of WPN252012H product, please refer to Fig.7-1 and Table 7-1.

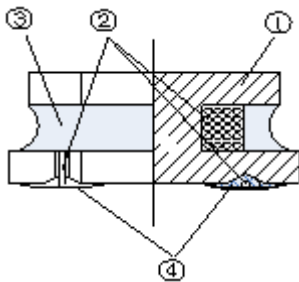

[Table 7-1]

No.	Components	Material
①	Core	Soft magnetic Metal
②	Wire	Polyurethane system enameled copper wire
③	Magnetic Glue	Epoxy resin and magnetic powder
④	Electrodes	substrate+Top Electrodes

8 Product Marking

Add a mark on the side of lead wire. Refer to Fig.8-1.



Fig.8-1

9 Reliability Test

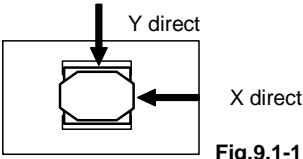
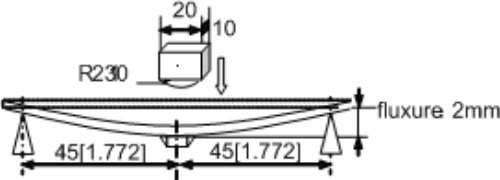
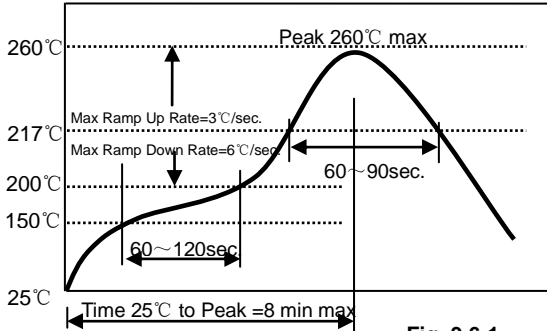
Items	Requirements	Test Methods and Remarks
9.1 Terminal Strength	No removal or split of the termination or other defects shall occur.  <p style="text-align: center;">Fig.9.1-1</p>	① Solder the inductor to the testing jig (glass epoxy board shown in Fig.9.1-1) using eutectic solder. Then apply a force in the direction of the arrow. ② 10N force. ③ Keep time: 5s
9.2 Resistance to Flexure	No visible mechanical damage.  <p style="text-align: center;">Fig.9.2-1</p>	① Solder the chip to the test jig (glass epoxy board) using eutectic solder. Then apply a force in the direction shown as Fig.9.2-1 . ② Flexure: 2mm ③ Pressurizing Speed: 0.5mm/sec ④ Keep time: 30±1s ⑤ Test board size: 100X40X1.0 ⑥ Land dimension: Please see Fig. 3-1
9.3 Vibration	① No visible mechanical damage. ② Inductance change: Within ±10%	① Solder the chip to the testing jig (glass epoxy board shown as the following figure) using eutectic solder. ② The chip shall be subjected to a simple harmonic motion having total amplitude of 1.5mm, the frequency being varied uniformly between the approximate limits of 10 and 55 Hz. ③ The frequency range from 10 to 55 Hz and return to 10 Hz shall be traversed in approximately 1 minute. This motion shall be applied for a period of 2 hours in each 3 mutually perpendicular directions (total of 6 hours).
9.4 Temperature coefficient	Inductance change: Within ±20%	① Temperature: -40°C ~ +125°C ② With a reference value of +20°C, change rate shall be calculated
9.5 Solderability	90% or more of electrode area shall be coated by new solder.	① The test samples shall be dipped in flux, and then immersed in molten solder. ② Solder temperature: 245±5°C ③ Duration: 5±1 sec. ④ Solder: Sn/3.0Ag/0.5Cu ⑤ Flux: 25% resin and 75% ethanol in weight ⑥ Immersion depth: all sides of mounting terminal shall be immersed
9.6 Resistance to Soldering Heat	① No visible mechanical damage. ② Inductance change: Within ±10%	① Re-flowing Profile: Please refer to Fig. 9.6-1 . ② Test board thickness: 1.0mm ③ Test board material: glass epoxy resin ④ The chip shall be stabilized at normal condition for 1~2 hours before measuring  <p style="text-align: right;">Fig. 9.6-1</p>

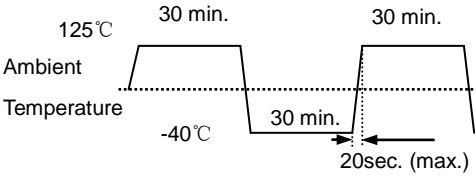
<p>9.7 Thermal Shock</p>	<p>① No visible mechanical damage. ② Inductance change: Within $\pm 10\%$</p>  <p style="text-align: center;">Fig.9.7-1</p>	<p>① Temperature and time: $-40\pm 3^{\circ}\text{C}$ for 30 ± 3 min $\rightarrow 125^{\circ}\text{C}$ for 30 ± 3 min, please refer to Fig. 9.7-1. ② Transforming interval: Max. 20 sec ③ Tested cycle: 100 cycles ④ The chip shall be stabilized at normal condition for 1~2 hours before measuring</p>
<p>9.8 Resistance to Low Temperature</p>	<p>① No visible mechanical damage ② Inductance change: Within $\pm 10\%$</p>	<p>① Temperature: $-40\pm 3^{\circ}\text{C}$ ② Duration: $1000^{\pm 24}$ hours ③ The chip shall be stabilized at normal condition for 1~2 hours before measuring</p>
<p>9.9 Resistance to High Temperature</p>	<p>① No mechanical damage. ② Inductance change: Within $\pm 10\%$</p>	<p>① Temperature: $125\pm 2^{\circ}\text{C}$ ② Duration: $1000^{\pm 24}$ hours ③ The chip shall be stabilized at normal condition for 1~2 hours before measuring.</p>
<p>9.10 Damp Heat</p>	<p>① No mechanical damage. ② Inductance change: Within $\pm 10\%$</p>	<p>① Temperature: $60\pm 2^{\circ}\text{C}$ ② Humidity: 90% to 95%RH ③ Duration: $1000^{\pm 24}$ hours ④ The chip shall be stabilized at normal condition for 1~2 hours before measuring</p>
<p>9.11 Loading Under Damp Heat</p>	<p>① No mechanical damage. ② Inductance change: Within $\pm 10\%$</p>	<p>① Temperature: $60\pm 2^{\circ}\text{C}$ ② Humidity: 90% to 95% RH ③ Applied current: Rated current ④ Duration: $1000^{\pm 24}$ hours ⑤ The chip shall be stabilized at normal condition for 1~2 hours before measuring</p>
<p>9.12 Loading at High Temperature</p>	<p>① No mechanical damage. ② Inductance change: Within $\pm 10\%$</p>	<p>① Temperature: $85\pm 2^{\circ}\text{C}$ ② Applied current: Rated current ③ Duration: $1000^{\pm 24}$ hours ④ The chip shall be stabilized at normal condition for 1~2 hours before measuring</p>

10 Packaging, Storage

10.1 Tape and Reel Packaging Dimensions

10.1.1 Taping Dimensions (Unit: mm)

Please refer to **Fig. 10.1.1-1** and **Table 10.1.1-1**.

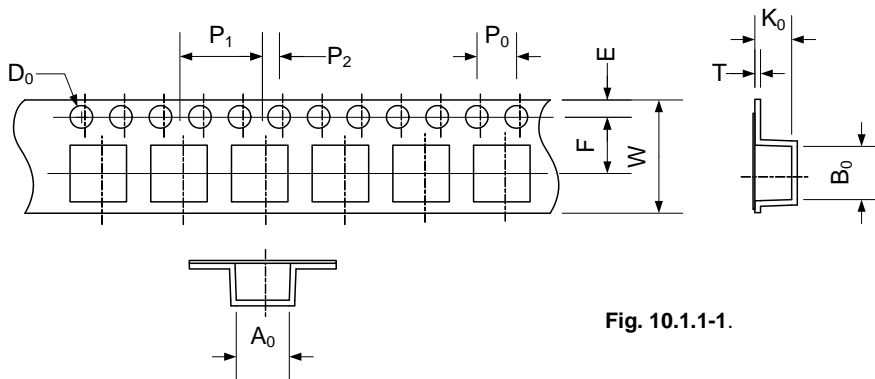

Fig. 10.1.1-1.

[Table 10.1.1-1]

Series	A ₀	B ₀	W	E	F	P ₀	P ₁	P ₂	D ₀	T	K ₀
WPN252012H	2.45±0.05	2.75±0.05	8.0±0.1	1.75±0.1	3.5±0.05	4.0±0.1	4.0±0.1	2.0±0.1	1.5+0.1/-0.0	0.25±0.03	1.55±0.05

10.1.2 Direction of rolling

Please refer to Fig. 10.1.2.

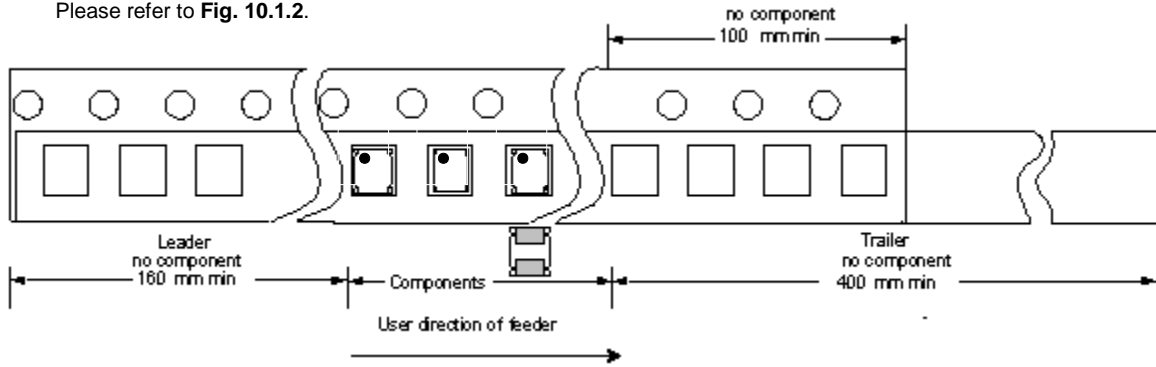

Fig. 10.1.2.

10.1.3 Reel Dimensions (Unit: mm)

Please refer to Fig. 10.1.3.

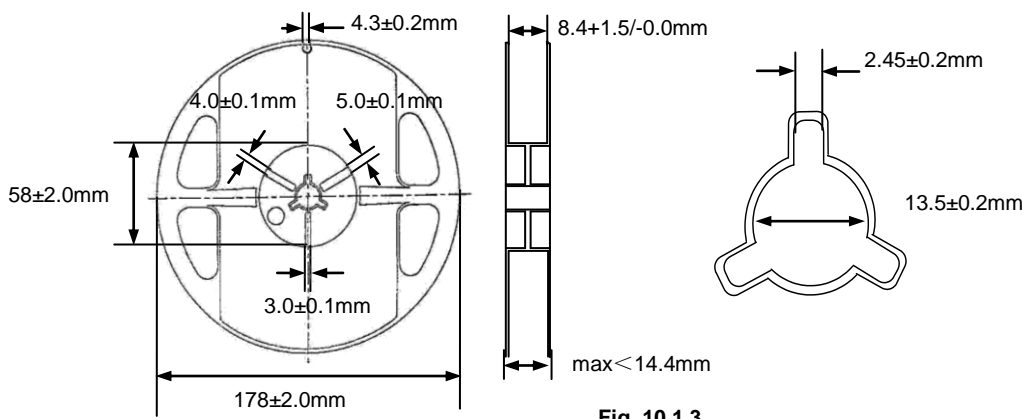

Fig. 10.1.3

10.1.4 Top tape strength

Peel-off strength: 10~100gf.

Peel-off angle: 165°~180°, refers to Fig.10.1.4.

Peel-off speed: 300mm/min.

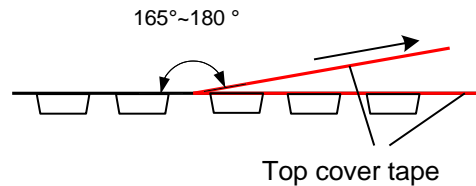

Fig. 10.1.4

10.1.5 The number of components

A tape & reel package contains 2000 inductors.

10.1.6 The allowable number of empty chip cavities

Maximum two (2) chip cavities missing product may exist in a reel but they may not be consecutive two cavities.

10.2 Packing Documents and Marking

10.2.1 Packing Documents

Packing documents include the following:

- 1) Packaging list
- 2) Certificate of compliance (COC)

10.2.2

Packing QTY.

- 1) Inner Box: 10 reel in each box.
- 2) Outer Box: 4 or 8 inner boxes in each outer case.
- 3) 40 or 80 reels in each outer case.

10.2.3

Marking

1) Marking label information on reels includes (see Fig.10.2.3-1, Fig.10.2.3-2A/2B):

- a). Sunlord P/N.
- b). Quantity per reel
- c). Lot number
- d). Inspection No.
- e). Inspection stamp
- f). MFG address as 'Made In China'

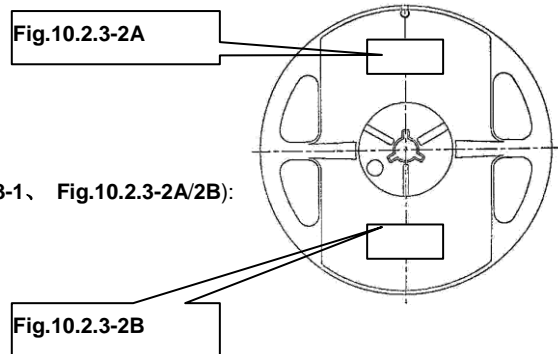

Fig.10.2.3-1

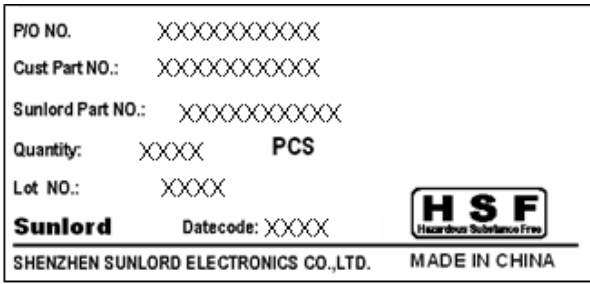

Fig.9.2.3-2A

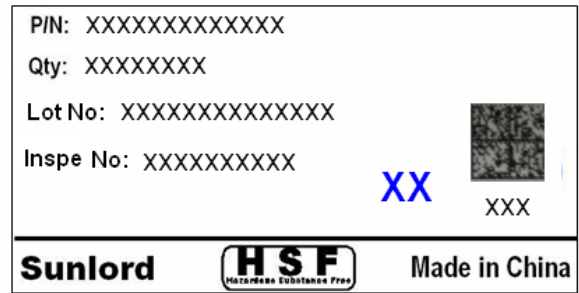

Fig.9.2.3-2B

- 2) Marking label information on inner box
- Inner box please refers to Fig.10.2.3-3 and Table 10.2.3-1
 - Marking Label on inner box (see Fig.10.2.3-4)

3) Marking on outer case (see Fig.10.2.3-5-7):

Out case size please refers to Table 10.2.3-2.

- Manufacturer: Sunlord ID:
"Shenzhen Sunlord Electronics Co., Ltd."
- Packing label include the following:
 - Customer
 - Manufacturer
 - Date code
 - C/No.

Example; "1/10" means that this case is the 1st one of total 10 cases

- P/O No.
- Customer Part No.
- Sunlord Part No.
- Quantity.
- Inspection Stamp.

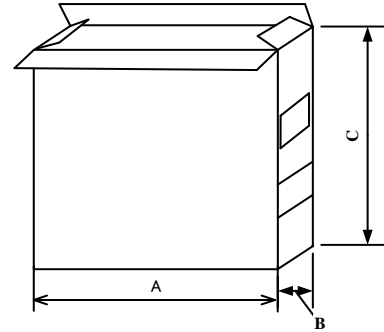

Fig.10.2.3-3

[Table 10.2.3-1]

Packaging type	A(mm)	B(mm)	C(mm)
Inner box	180	120	180

[Table 10.2.3-2]

Packaging type	L(mm)	W(mm)	H(mm)
Type1	505	378	200
Type2	380	260	200

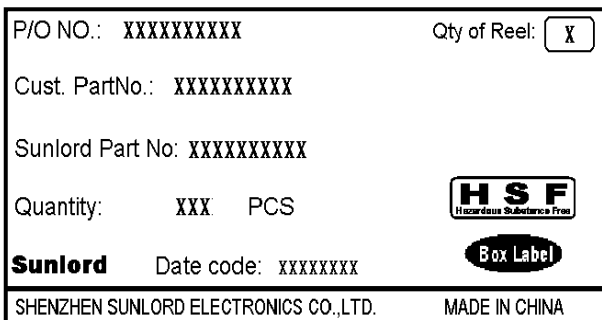

Fig.10.2.3-4

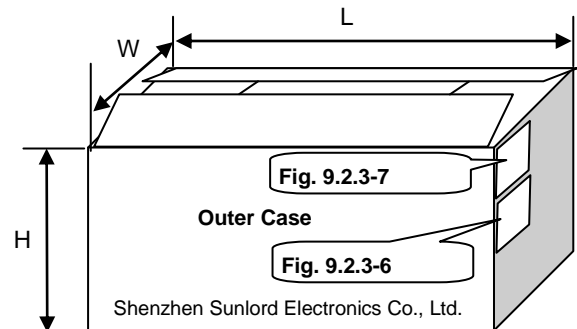

Fig. 10.2.3-5

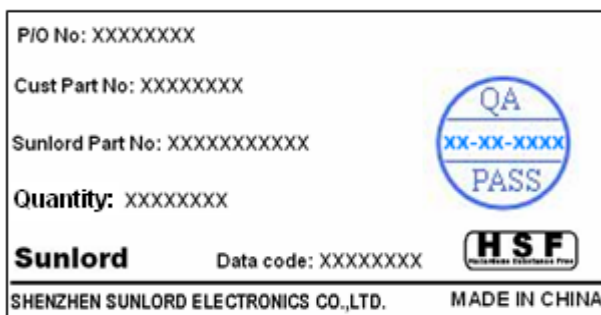

Fig.10.2.3-6

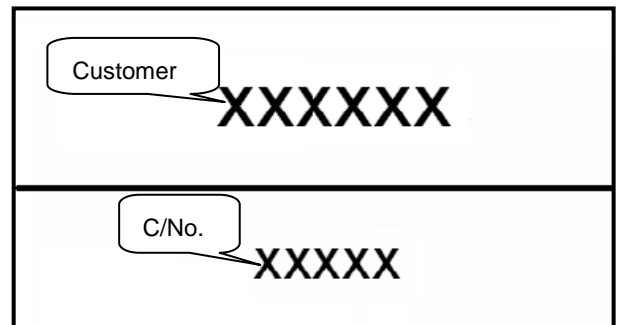
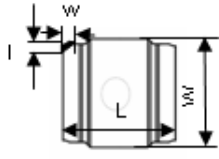
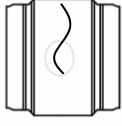
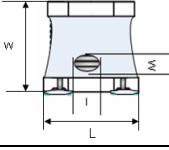
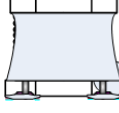
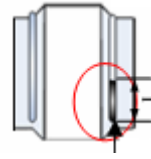
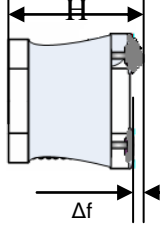
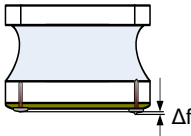

Fig.10.2.3-7

11 .Visual inspection standard of product

File No:		Applied to Wire Wound SMD Power Inductor Series		REV:01
Effective date:				
No.	Defect Item	Graphic	Rejection identification	Acceptance
1	Core defect		The defect length/width (l or w) more than $L/6$ or $W/6$, NG.	AQL=0.65
2	Core crack		Visual cracks, NG.	AQL=0.65
3	Starvation		Resin starved length, l , more than $L/2$, NG. ① IF $W > 2\text{mm}$, resin starved width, w , more than $W/2$, NG. ② IF $W \leq 2\text{mm}$, resin starved width, w , don't control.	AQL=0.65
4	Excessive glue		The length, width or height of product beyond specified value, NG.	AQL=0.65
5	Cold solder		Cold solders l more than 1mm, NG.	AQL=0.65
6	Solder icicle		① The height H of product beyond specified value, NG; ② The clearance Δf beyond specified value listed in Item 5, NG;	AQL=0.65
7	Electrode uneven		The clearance Δf beyond specified value listed in Item 5, NG;	AQL=0.65

12 Recommended Soldering Technologies

12.1 Re-flowing Profile:

- △ Preheat condition: 150 ~200°C/60~120sec.
 - △ Allowed time above 217°C: 60~90sec.
 - △ Max temp: 260°C
 - △ Max time at max temp: 5sec.
 - △ Solder paste: Sn/3.0Ag/0.5Cu
 - △ Allowed Reflow time: 2x max
- Please refer to Fig. 11.1-1.

[Note: The reflow profile in the above table is only for qualification and is not meant to specify board assembly profiles. Actual board assembly profiles must be based on the customer's specific board design, solder paste and process, and should not exceed the parameters as the Reflow profile shows.]

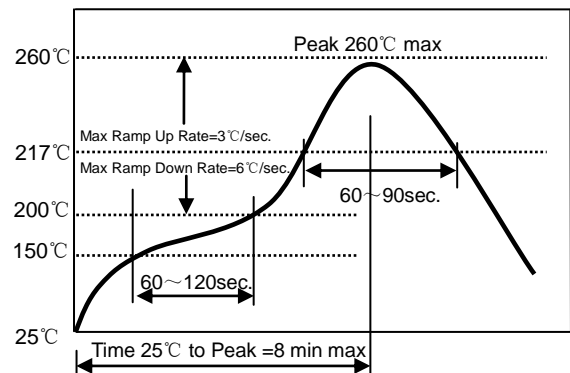

Fig. 12.1-1

12.2 Iron Soldering Profile

- △ Iron soldering power: Max. 30W
- △ Pre-heating: 150°C/60sec.
- △ Soldering Tip temperature: 350°C Max.
- △ Soldering time: 3sec. Max.
- △ Solder paste: Sn/3.0Ag/0.5Cu
- △ Max.1 times for iron soldering

Please refer to **Fig. 12.2-1**.

[Note: Take care not to apply the tip of the soldering iron to the terminal electrodes.]

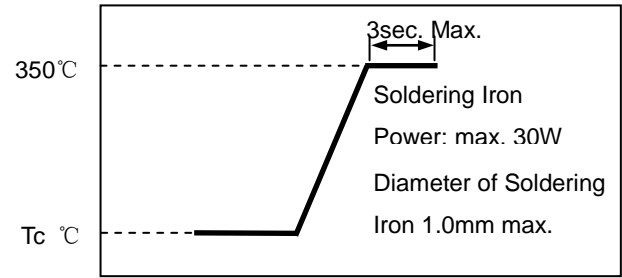

Fig. 12.2-1

13 Precautions**13.1 Surface mounting**

- Mounting and soldering condition should be checked beforehand.
- Applicable soldering process to this product is reflow soldering only.
- Recommended conditions for repair by soldering iron:
Preheat the circuit board with product to repair at 150°C for about 1 minute.
Put soldering iron on the land-pattern.
Soldering iron's temperature: 350°C maximum/Duration: 3 seconds maximum/1 time for each terminal.
The soldering iron should not directly touch the inductor.
Product once removes from the circuit board may not be used again.

13.2 Handling

- Keep the products away from all magnets and magnetic objects.
- Be careful not to subject the products to excessive mechanical shocks.
- Please avoid applying impact to the products after mounted on pc board.
- Avoid ultrasonic cleaning.

13.3 Storage

- To maintain the solderability of terminal electrodes and to keep the packing material in good condition, temperature and humidity in the storage area should be controlled.
- Recommended conditions: -10°C~40°C, 70%RH (Max.)
- Even under ideal storage conditions, solderability of products electrodes may decrease as time passes. For this reason, product should be used with one year from the time of delivery.
- In case of storage over 6 months, solderability shall be checked before actual usage.

13.4 Regarding Regulations

- Any Class- I or Class- II ozone-depleting substance (ODS) listed in the Clean Air Act in US for regulation is not included in the products or applied to the products at any stage of whose manufacturing processes.
- Certain brominated flame retardants (PBBs, PBDEs) are not used at all.
- The products of this specification are not subject to the Export Trade Control Order in China or the Export Administration Regulations in US.

13.5 Guarantee

- The guaranteed operating conditions of the products are in accordance with the conditions specified in this specification.
- Please note that Sunlord takes no responsibility for any failure and/or abnormality which is caused by use under other than the aforesaid operating conditions.

14 Supplier Information**14.1 Supplier:**

Shenzhen Sunlord Electronics Co., Ltd.

14.2 Manufacturer:

Shenzhen Sunlord Electronics Co., Ltd.

14.3 Manufacturing Address:

Sunlord Industrial Park, Dafuyuan Industrial Zone, Guanlan, Shenzhen, China

Zip: 518110