

# SMD Power Inductor CDRH12D58/A



## Description

- Ferrite drum core construction.
- Magnetically shielded.
- L × W × H: 12.5 × 12.5 × 6.0 mm Max.
- Product weight: 3.2 g(Ref.)
- Moisture Sensitivity Level: 1
- RoHS compliance.
- Qualification to AEC-Q200.

## Environmental Data

- Operating temperature range: -40°C ~ +125°C (including coil's self temperature rise)
- Storage temperature range: -40°C ~ +85°C
- Solder reflow temperature: 260 °C peak.

## Packaging

- Carrier tape and reel packaging
- 13.0" diameter reel
- 500pcs per reel

## Applications

- Automotive and other high temperature, high reliability application.

## Dimension - [mm]

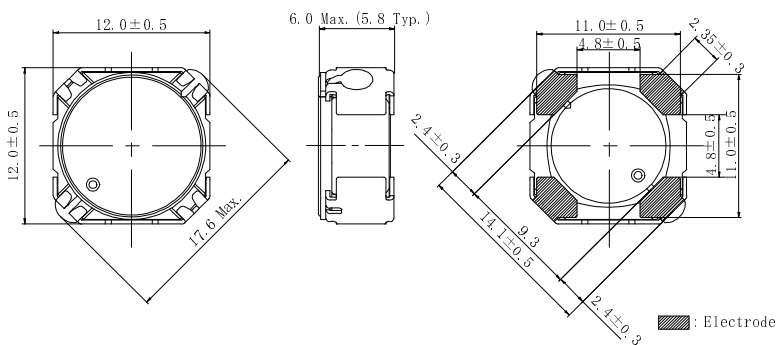

## Land pattern and Schematics - [mm]

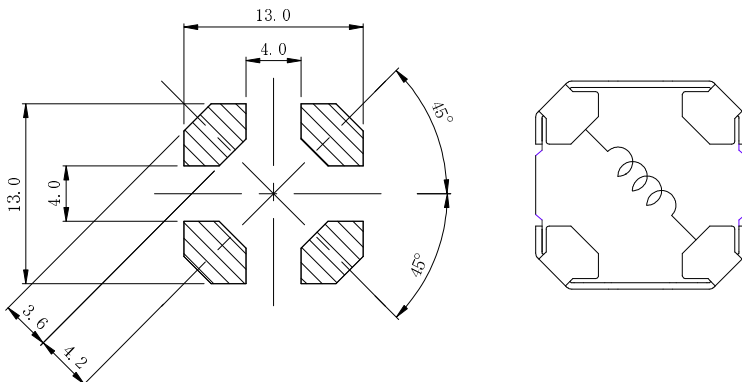

# SMD Power Inductor CDRH12D58/A



## Electrical Characteristics

Part No.	Stamp	Inductance ( $\mu$ H) [Within] ※1	D.C.R. (m $\Omega$ ) [Max.] (Typ.) (at 20°C)	Rated current (at 125°C) (A)※2
CDRH12D58/ANP-100MC	100M	10 $\pm$ 20%	22(17)	3.8
CDRH12D58/ANP-120MC	120M	12 $\pm$ 20%	24(19)	3.7
CDRH12D58/ANP-150MC	150M	15 $\pm$ 20%	29(23)	3.1
CDRH12D58/ANP-180MC	180M	18 $\pm$ 20%	38(30)	2.9
CDRH12D58/ANP-220MC	220M	22 $\pm$ 20%	42(33)	2.7
CDRH12D58/ANP-270MC	270M	27 $\pm$ 20%	57(45)	2.4
CDRH12D58/ANP-330MC	330M	33 $\pm$ 20%	60(48)	2.2
CDRH12D58/ANP-390MC	390M	39 $\pm$ 20%	88(70)	1.9
CDRH12D58/ANP-470MC	470M	47 $\pm$ 20%	98(78)	1.8
CDRH12D58/ANP-560MC	560M	56 $\pm$ 20%	108(86)	1.7
CDRH12D58/ANP-680MC	680M	68 $\pm$ 20%	118(94)	1.6
CDRH12D58/ANP-820MC	820M	82 $\pm$ 20%	175(140)	1.4
CDRH12D58/ANP-101MC	101M	100 $\pm$ 20%	223(178)	1.3
CDRH12D58/ANP-121MC	121M	120 $\pm$ 20%	247(197)	1.2
CDRH12D58/ANP-151MC	151M	150 $\pm$ 20%	280(224)	1.1
CDRH12D58/ANP-181MC	181M	180 $\pm$ 20%	307(245)	1.0
CDRH12D58/ANP-221MC	221M	220 $\pm$ 20%	453(362)	0.80
CDRH12D58/ANP-271MC	271M	270 $\pm$ 20%	550(440)	0.74
CDRH12D58/ANP-331MC	331M	330 $\pm$ 20%	623(498)	0.69
CDRH12D58/ANP-391MC	391M	390 $\pm$ 20%	723(578)	0.63

※1. Measuring condition: at 100 kHz.

※2. Rated current: The DC current at which the inductance decreases to 65% of its nominal value or when  $\Delta t=30^{\circ}\text{C}$ , whichever is lower .

# SMD Power Inductor CDRH12D58/A



## Saturation Current & Temperature Rise Graph

— L (20°C) — L (125°C) —  $\Delta T$

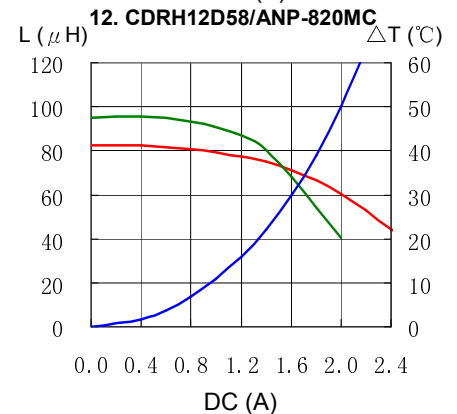
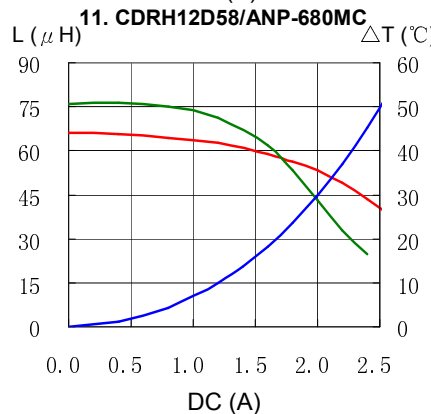
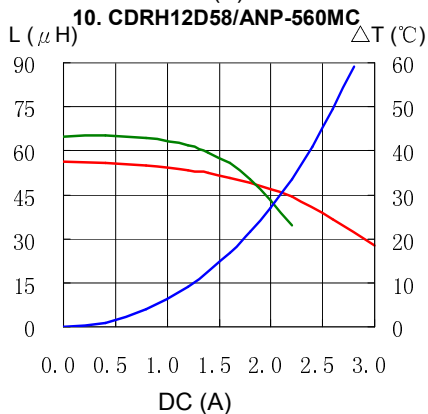
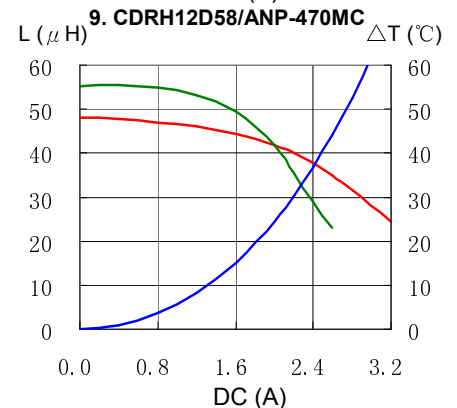
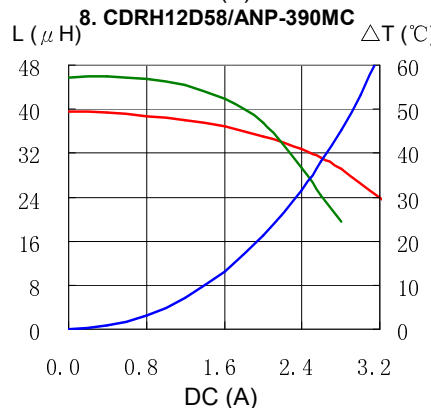
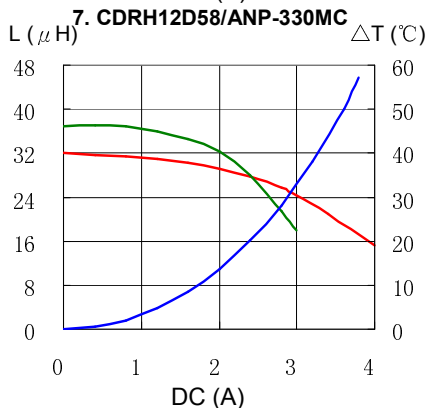
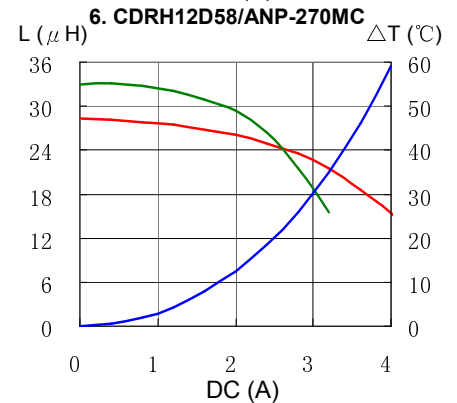
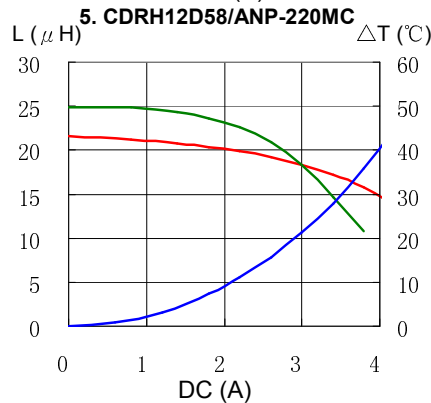
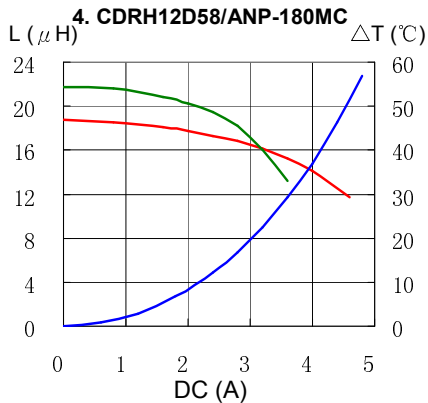
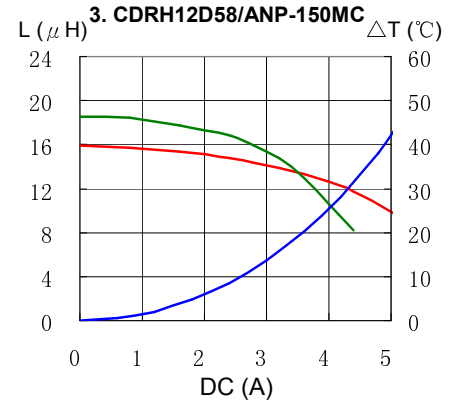
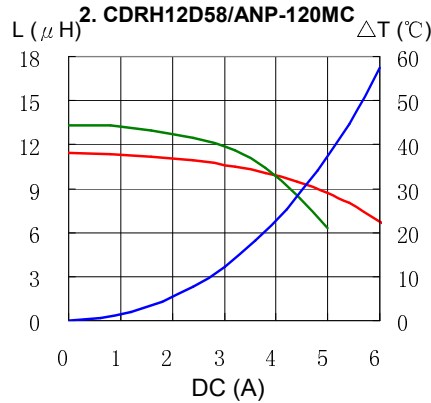
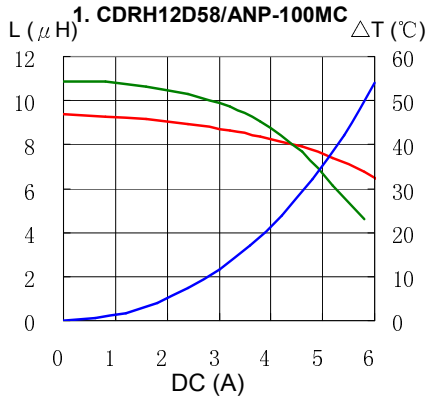

# SMD Power Inductor CDRH12D58/A



## Saturation Current & Temperature Rise Graph

— L (20°C) — L (125°C) —  $\Delta T$

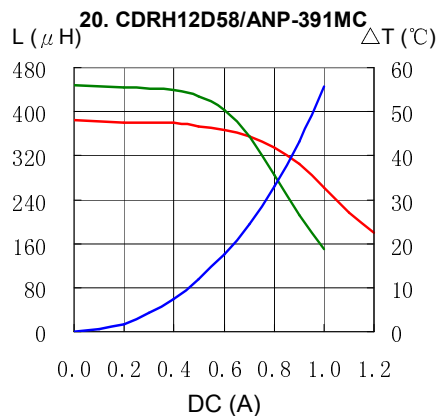
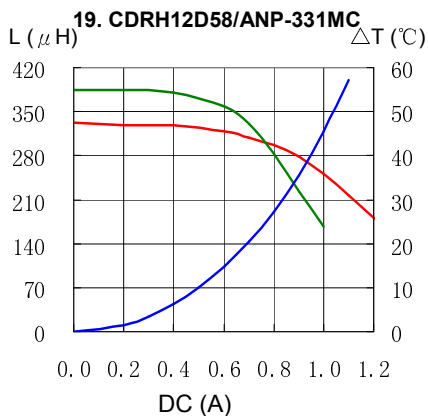
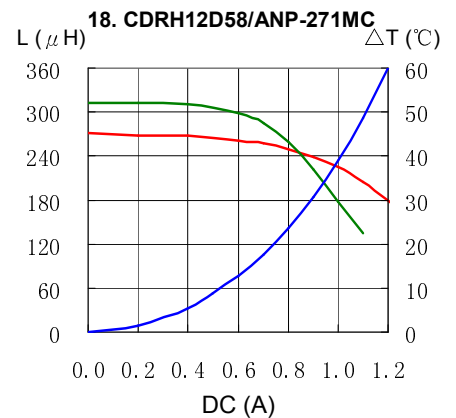
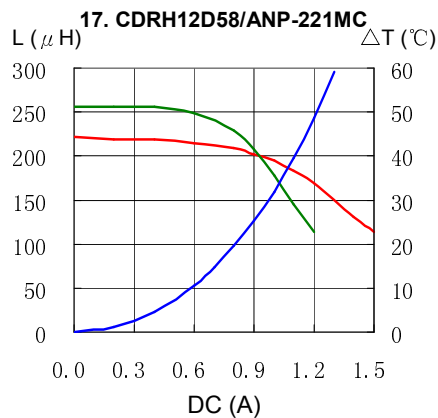
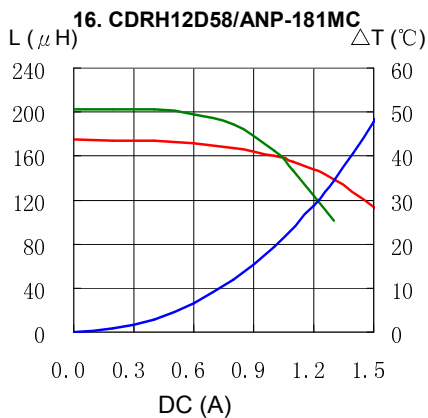
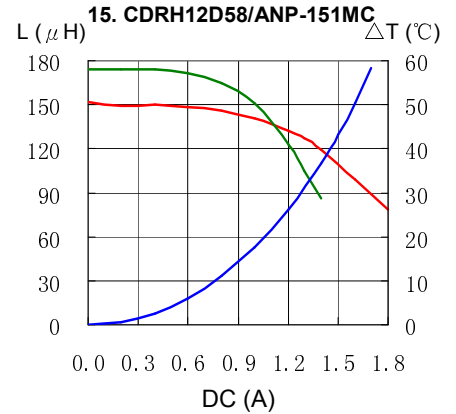
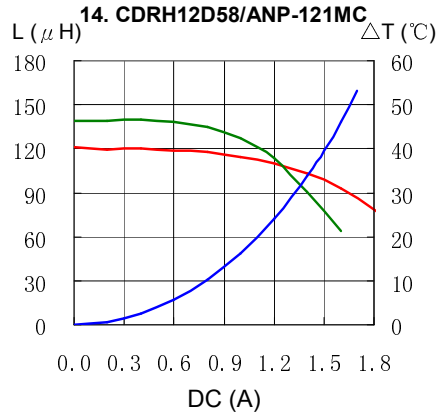
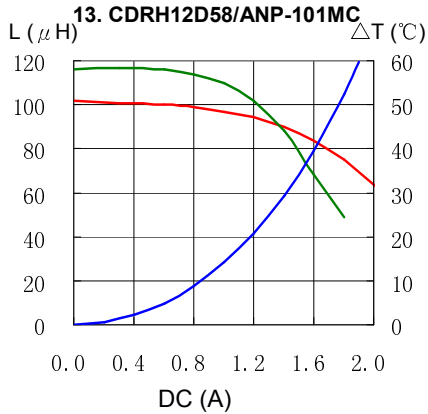

# SMD Power Inductor CDRH12D58/A



## Solder Reflow Condition

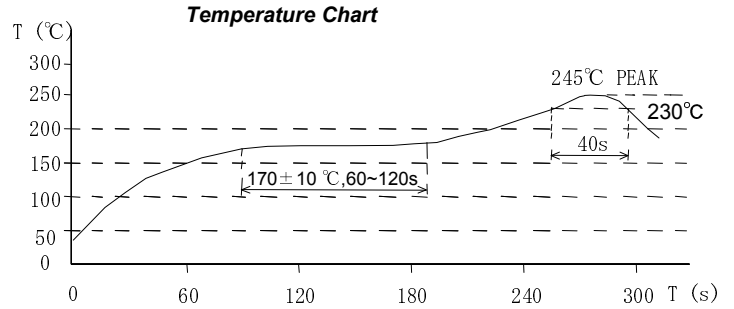
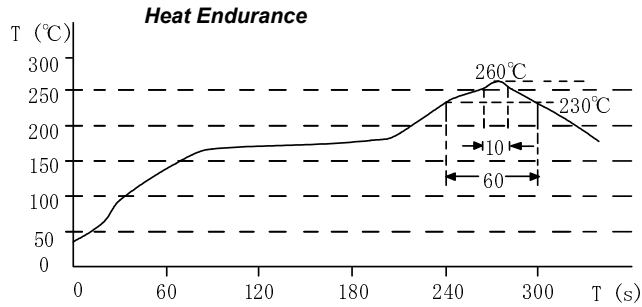

Please refer to the sales offices on our website - <http://www.sumida.com>

### Hong Kong

Tel.+852-2880-6781  
FAX.+852-2565-9600  
[sales@hk.sumida.com](mailto:sales@hk.sumida.com)

### Saitama(Japan)

Tel.+81-48-691-7300  
FAX.+81-48-691-7340  
[sales@jp.sumida.com](mailto:sales@jp.sumida.com)

### Chicago

Tel.+1-847-545-6700  
FAX. +1-847-545-6720  
[sales@us.sumida.com](mailto:sales@us.sumida.com)

### Shanghai

Tel.+86-21-5836-3299  
FAX.+86-21-5836-3266  
[shanghai.sales@cn.sumida.com](mailto:shanghai.sales@cn.sumida.com)

### Seoul

Tel.+82-2-6237-0777  
FAX.+82-2-6237-0778  
[sales@kr.sumida.com](mailto:sales@kr.sumida.com)

### Oberzell

Tel.+49-8591-937-0  
FAX. +49-8591-937-103  
[contact@eu.sumida.com](mailto:contact@eu.sumida.com)

### Shenzhen

Tel.+86-755-8291-0228  
FAX.+86-755-8291-0338  
[shenzhen.sales@cn.sumida.com](mailto:shenzhen.sales@cn.sumida.com)

### Singapore

Tel.+65-6296-3388  
FAX.+65-6841-4426  
[sales@sg.sumida.com](mailto:sales@sg.sumida.com)

### Neumarkt

Tel.+49-9181-4509-110  
FAX. +49-9181-4509-310  
[infocomp@eu.sumida.com](mailto:infocomp@eu.sumida.com)

### Taipei

Tel.+886-2-8751-2737  
FAX.+886-2-8751-2738  
[sales@tw.sumida.com](mailto:sales@tw.sumida.com)

### San Jose

Tel.+1-408-321-9660  
FAX.+1-408-321-9308  
[sales@us.sumida.com](mailto:sales@us.sumida.com)