

Inductor



Figure



Type A



Type B



Type C

Note: The image shown here is indicative only. If there is inconsistency between the image and the actual product, the actual product shall govern.

Specifications:

<u>SERIES : SKPC-ERCB7-XXX</u>	
Test Conditions:	25°C 10KHz 1V
Inductance :	7μH±5% (No Current)
Dimensions(L*W*H):	43*33*13mm
Pins and Connection	2*Terminals
Hi-Pot(Wire to Core)	1KV/3KV/5KV DC①

Model	Type	DCR Max 20°C	Isat L drops 20% (Max)	Irms Temperature Rise 40°C (Max.) @	Weight (Max)
SKPC-ERCB7-3B(135)	B	1.2mΩ	21A	19.2A	51g
SKPC-ERCB7-4B(135)	B	3.7mΩ	23A	19.2A	55g
SKPC-ERCB7-5C(135)	C	2.6mΩ	39A	9.6A	59g
SKPC-ERCB7-6C(135)	C	3.3mΩ	46A	9.6A	63g
SKPC-ERCB7-7C(135)	C	8.4mΩ	55A	4.8A	53g
SKPC-ERCB7-8C(135)	C	9.4mΩ	63A	4.8A	55g
SKPC-ERCB7-9C(135)	C	10.4mΩ	72A	4.8A	55g
SKPC-ERCB7-10C(135)	C	11.5mΩ	89A	4.8A	57g

Operating temperature: -40°C to +75°C

Inductor



Note:

1. Classification of different Hi-Pot level : 1-1KVDC/3-3KVDC/5-5KVDC
2. Since different ways of heat dissipation affect Temperature rise, Temperature rise is reference.

Material List

No.	Item	Material Description
1	Core	Ferrite
2	Wire	Copper
3	Solder (Lead Free)	SnAg3%Cu
4	Insulation	Polyimide+Polyamide-imide Resin

Note: Temperature tolerance grade: **H CLASS**

Schematic Diagram

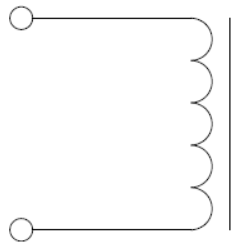

Configurations and Dimensions (mm)

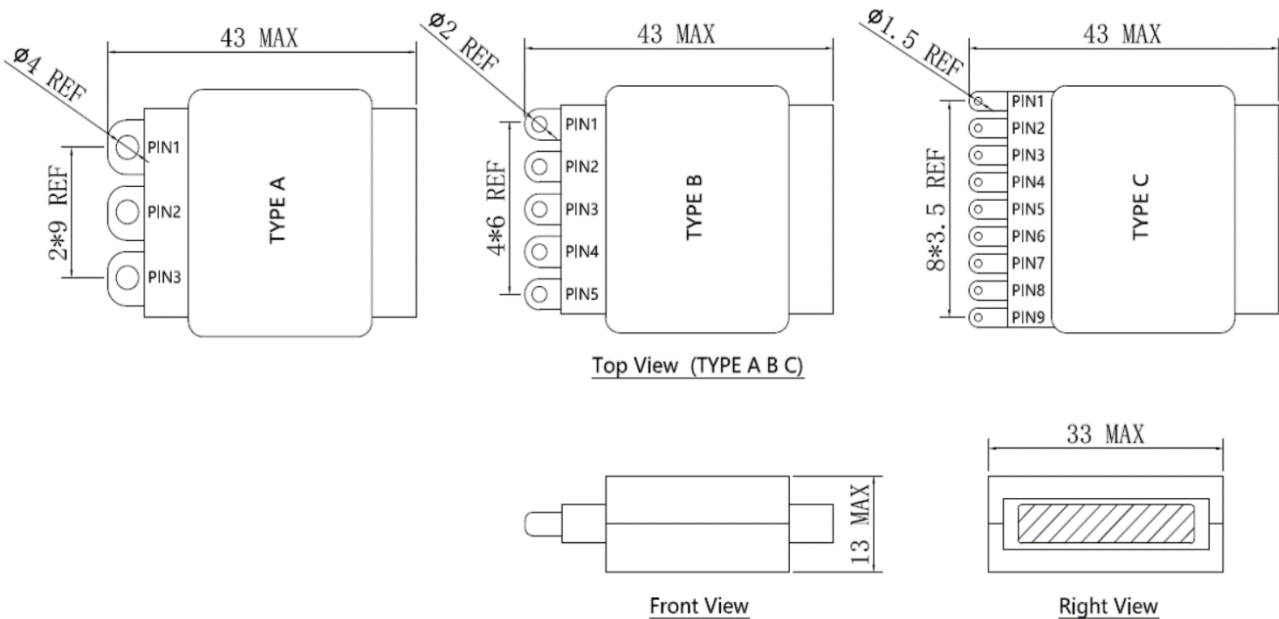

Inductor



Model.	Type	Description of pins
SKPC-ERCB7-3B(135)	B	PIN1+PIN4
SKPC-ERCB7-4B(135)	B	PIN1+PIN5
SKPC-ERCB7-5C(135)	C	PIN2+PIN7
SKPC-ERCB7-6C(135)	C	PIN2+PIN8
SKPC-ERCB7-7C(135)	C	PIN1+PIN8
SKPC-ERCB7-8C(135)	C	PIN1+PIN9
SKPC-ERCB7-9C(135)	C	PIN1+PIN8
SKPC-ERCB7-10C(135)	C	PIN1+PIN9

L(uH) vs Frequency(KHz)

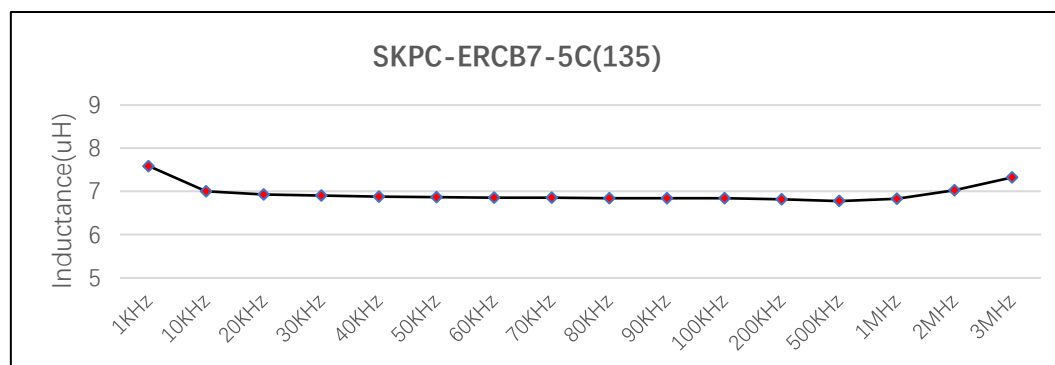
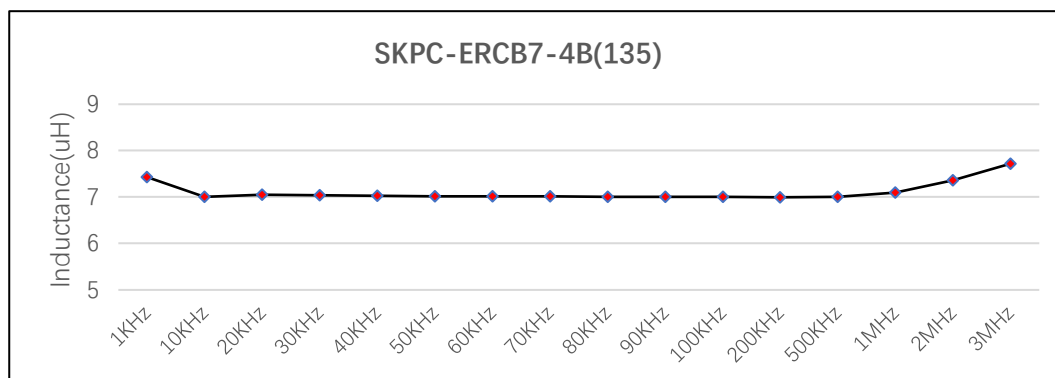
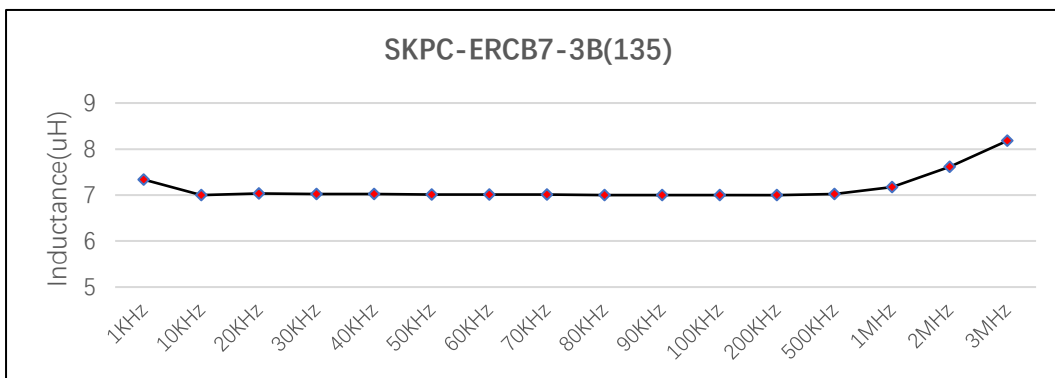

Inductor

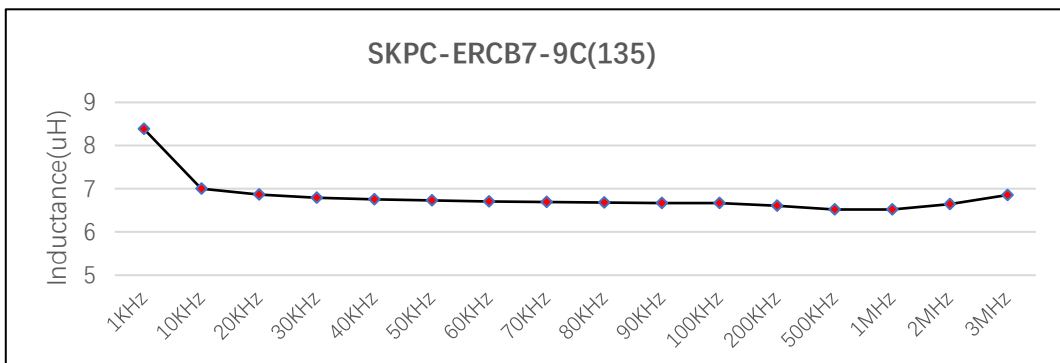
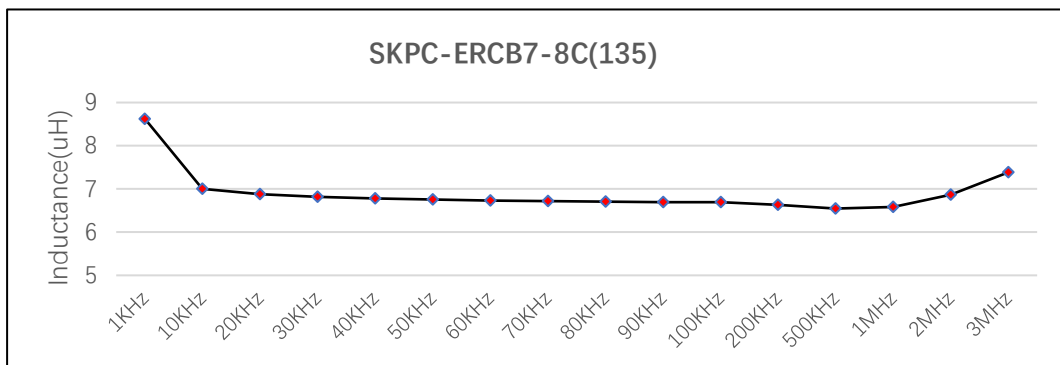
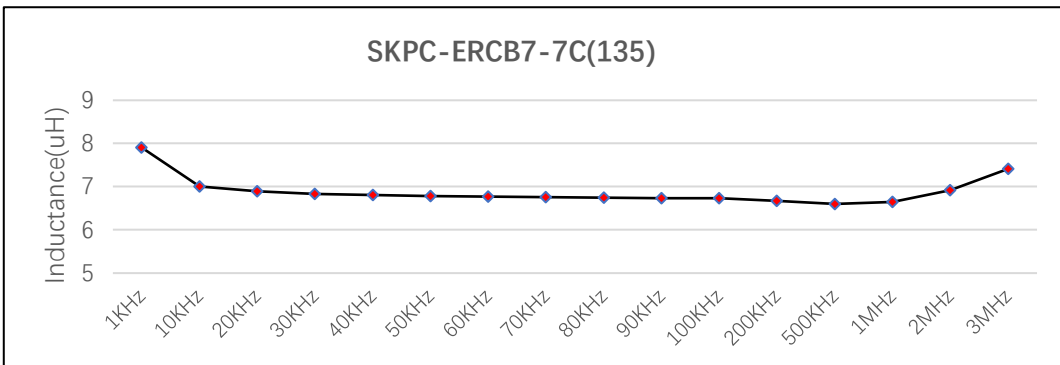
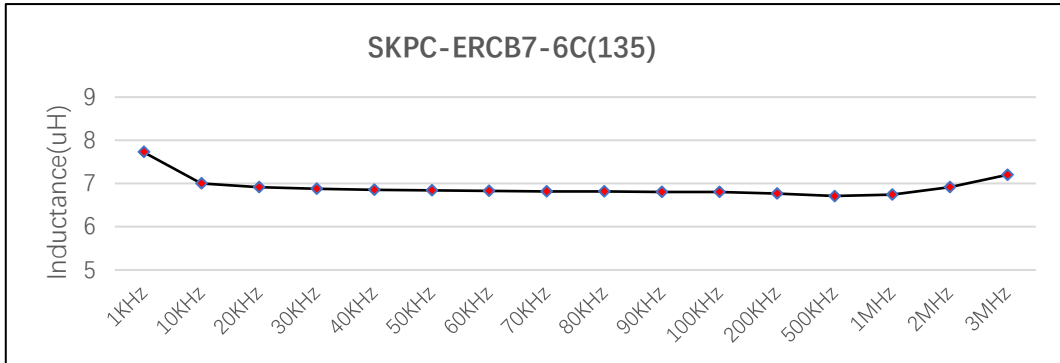

Inductor

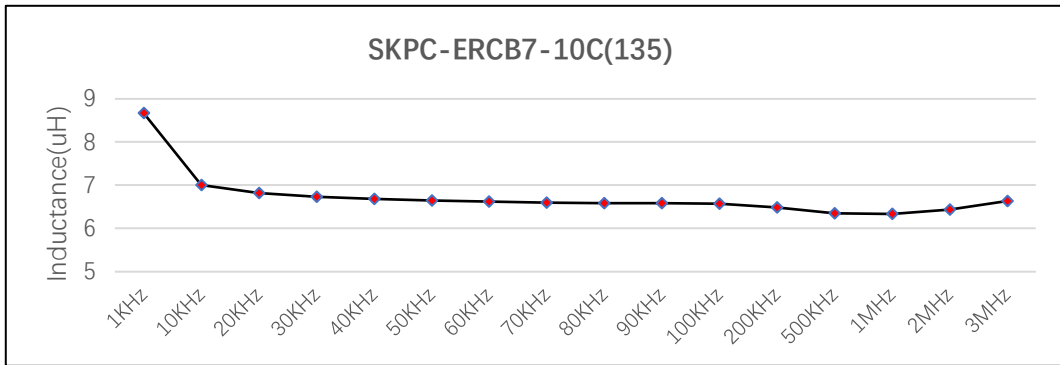

Note: This data is based on the WK-3260B.

L(uH) vs Current(A)

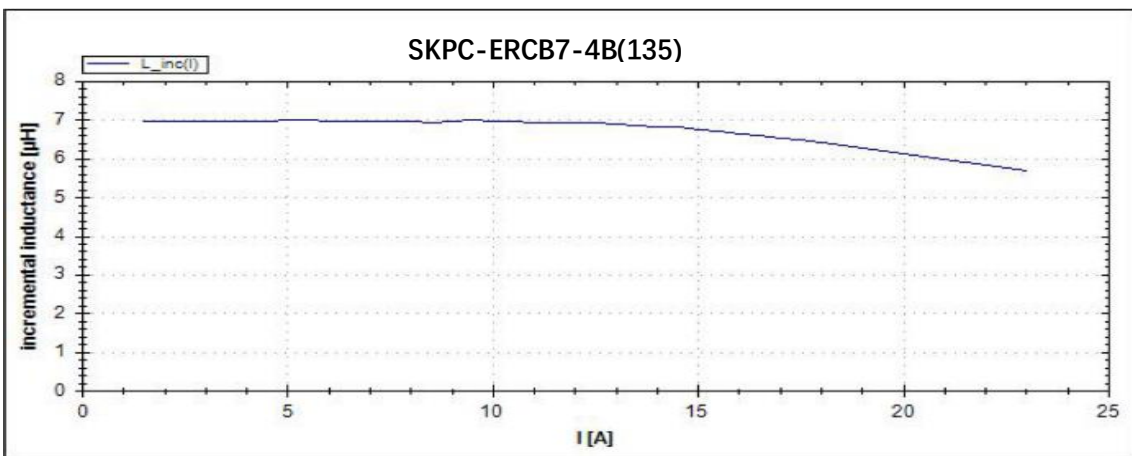
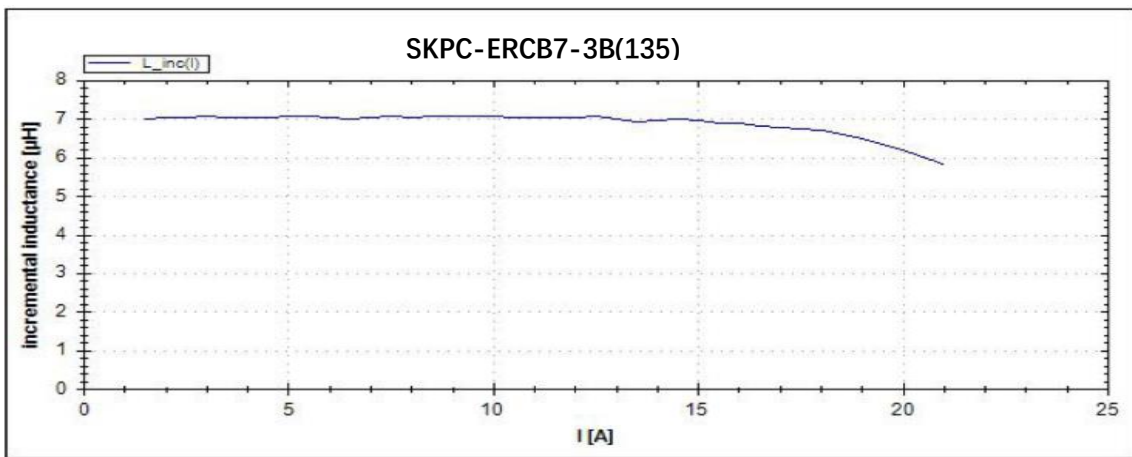

Inductor

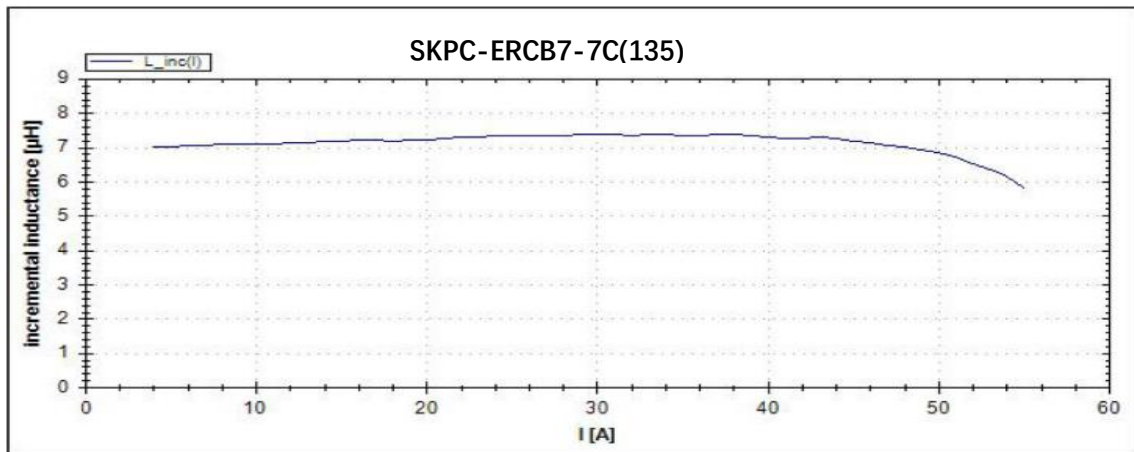
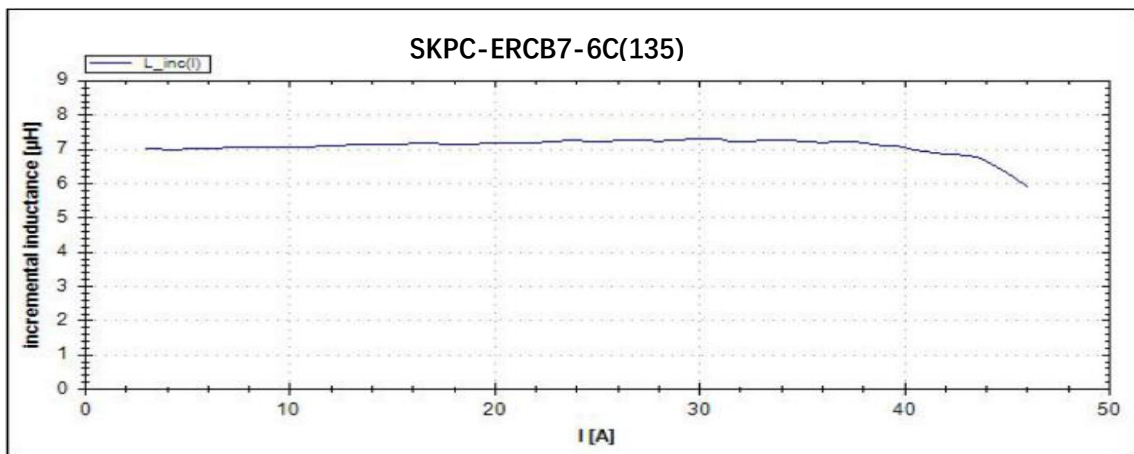
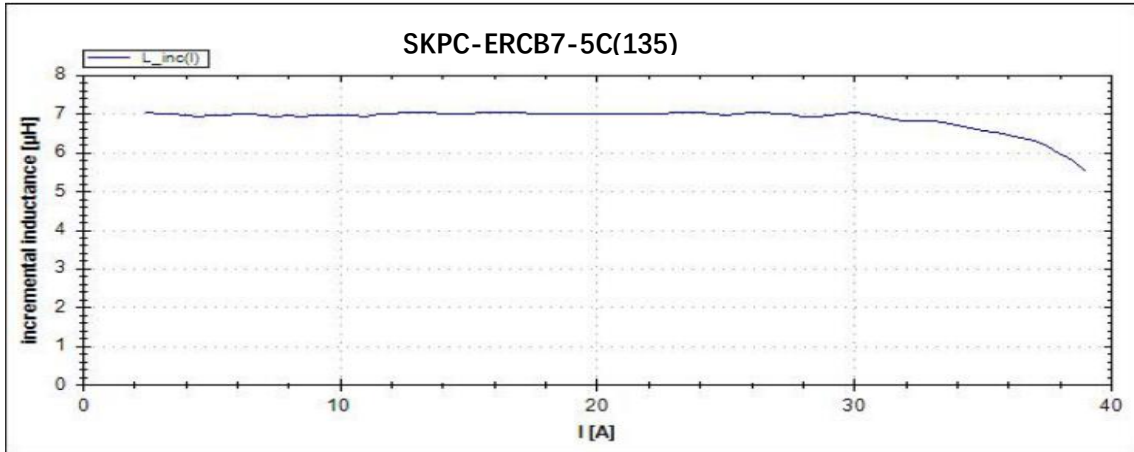

Inductor

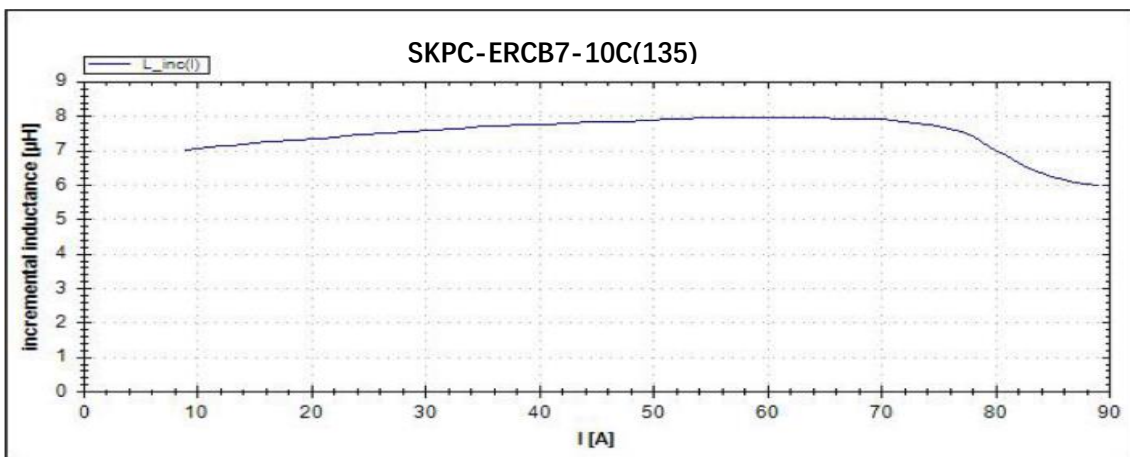
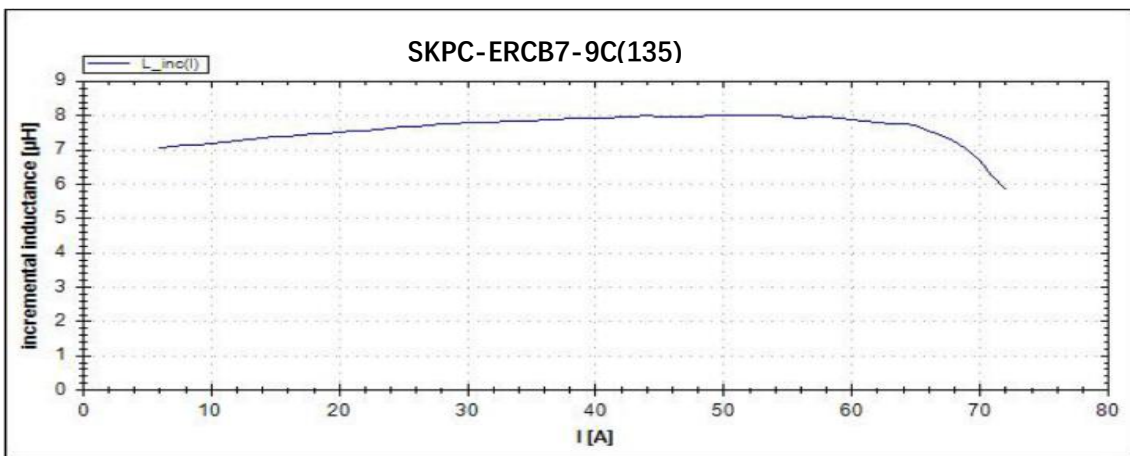
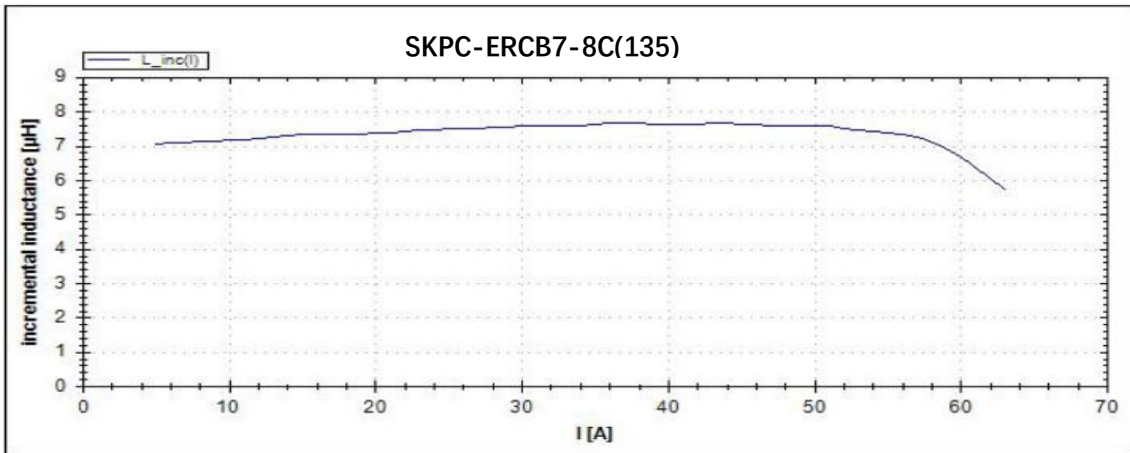

Note: This data is based on the DPG10 Power Choke Tester.