

Inductor



Figure



Type A



Type B



Type C

Note: The image shown here is indicative only. If there is inconsistency between the image and the actual product, the actual product shall govern.

Specifications:

<u>SERIES : SKPC-ERCB20-XXX</u>	
Test Conditions:	25°C 10KHz 1V
Inductance :	20μH±5% (No Current)
Dimensions(L*W*H):	43*33*13mm
Pins and Connection	2*Terminals
Hi-Pot(Wire to Core)	1KV/3KV/5KV DC ^①

Model	Type	DCR Max 20°C	Isat L drops 20% (Max)	Irms Temperature Rise 40°C (Max.) @	Weight (Max)
SKPC-ERCB20-5C(135)	C	3.4mΩ	12A	9.6A	59g
SKPC-ERCB20-6C(135)	C	3.3mΩ	15A	9.6A	63g
SKPC-ERCB20-7C(135)	C	8.4mΩ	17A	4.8A	53g
SKPC-ERCB20-8C(135)	C	9.4mΩ	20A	4.8A	55g
SKPC-ERCB20-9C(135)	C	10.4mΩ	23A	4.8A	55g
SKPC-ERCB20-10C(135)	C	11.5mΩ	26A	4.8A	57g
SKPC-ERCB20-11C(135)	C	12.9mΩ	29A	4.8A	57g
SKPC-ERCB20-12C(135)	C	14.1mΩ	32A	4.8A	57g

Operating temperature: -40°C to +75°C

Inductor



Note:

1. Classification of different Hi-Pot level : 1-1KVDC/3-3KVDC/5-5KVDC
2. Since different ways of heat dissipation affect Temperature rise, Temperature rise is reference.

Material List

No.	Item	Material Description
1	Core	Ferrite
2	Wire	Copper
3	Solder (Lead Free)	SnAg3%Cu
4	Insulation	Polyimide+Polyamide-imide Resin

Note: Temperature tolerance grade: **H CLASS**

Schematic Diagram

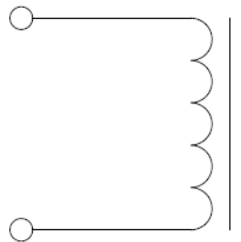

Configurations and Dimensions (mm)

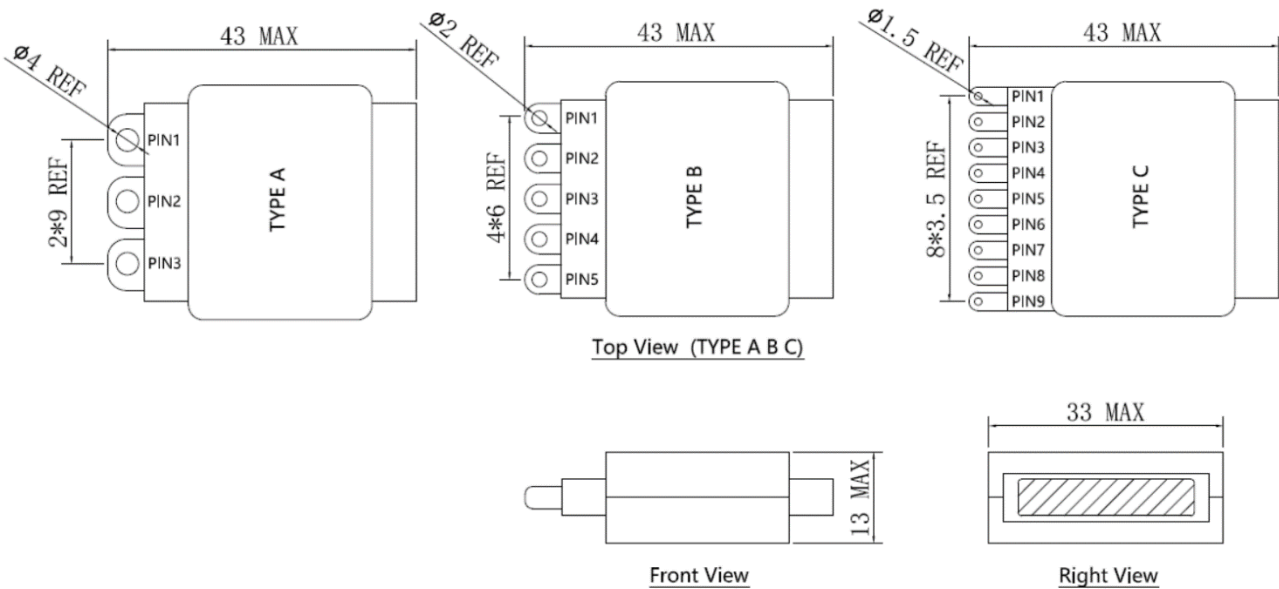

Inductor



Model.	Type	Description of pins
SKPC-ERCB20-5C(135)	C	PIN2+PIN7
SKPC-ERCB20-6C(135)	C	PIN2+PIN8
SKPC-ERCB20-7C(135)	C	PIN1+PIN8
SKPC-ERCB20-8C(135)	C	PIN1+PIN9
SKPC-ERCB20-9C(135)	C	PIN1+PIN8
SKPC-ERCB20-10C(135)	C	PIN1+PIN9
SKPC-ERCB20-11C(135)	C	PIN1+PIN8
SKPC-ERCB20-12C(135)	C	PIN1+PIN9

L(uH) vs Frequency(KHz)

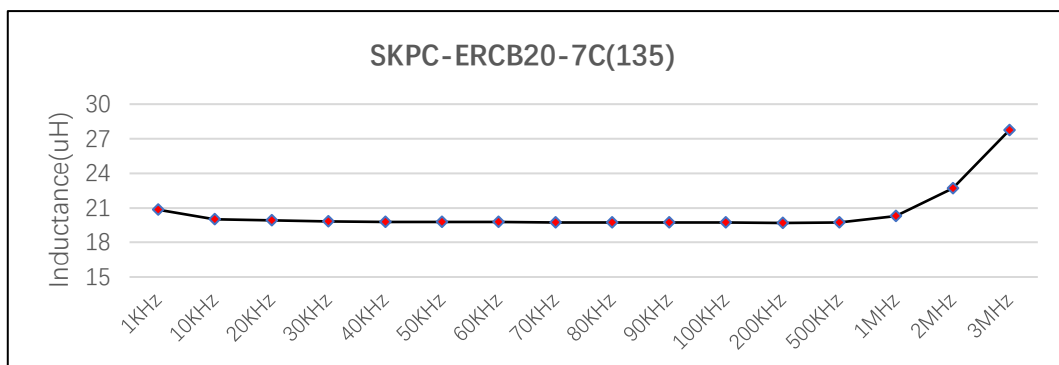
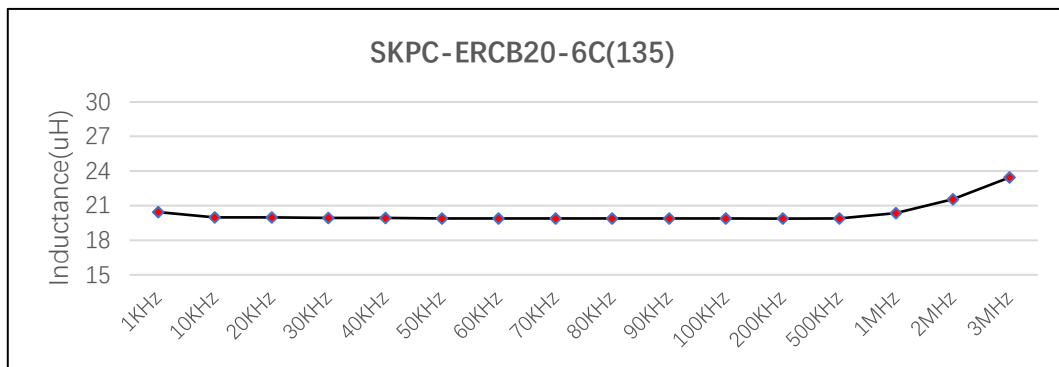
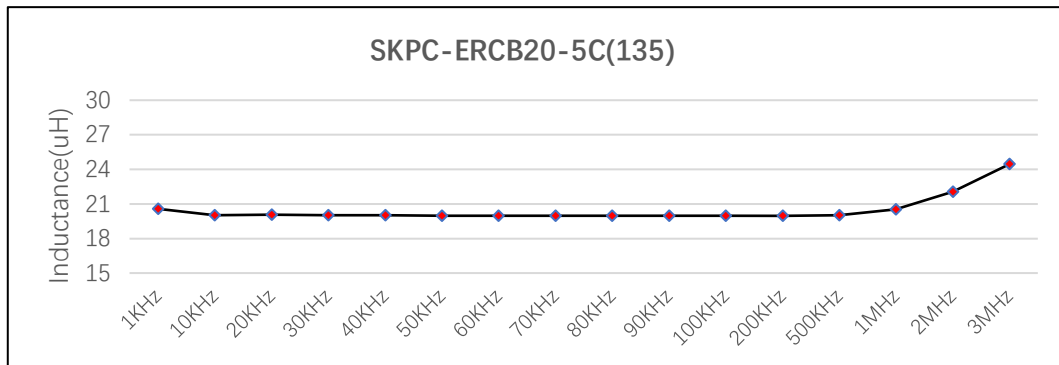

Inductor

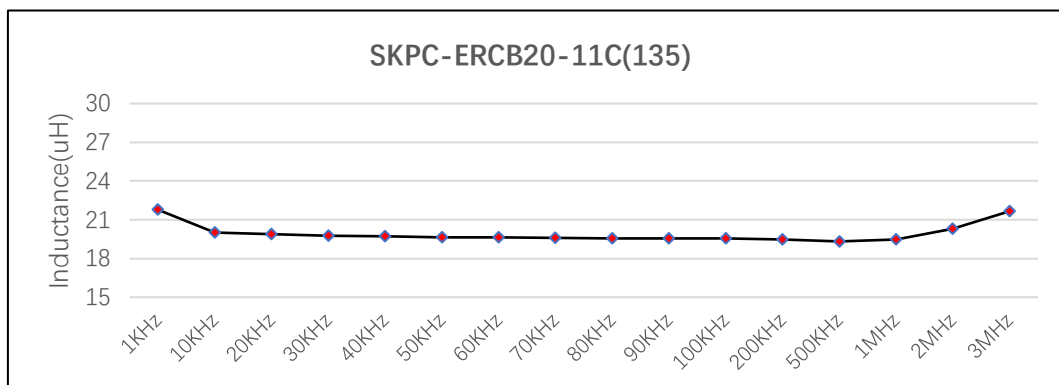
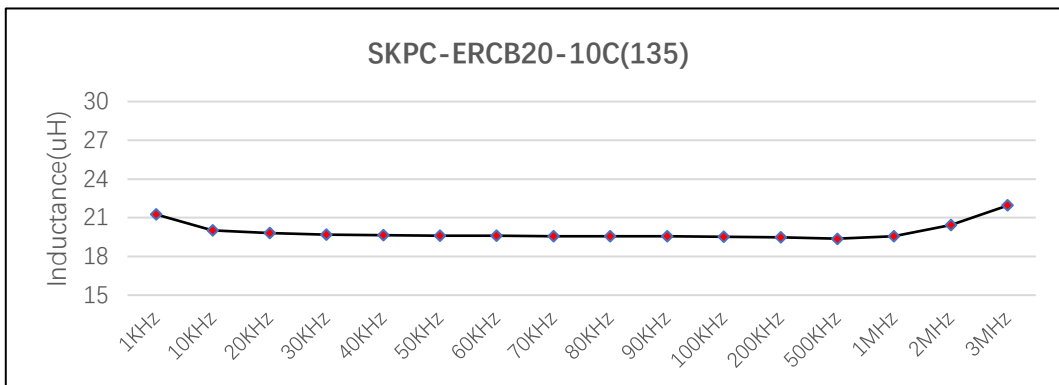
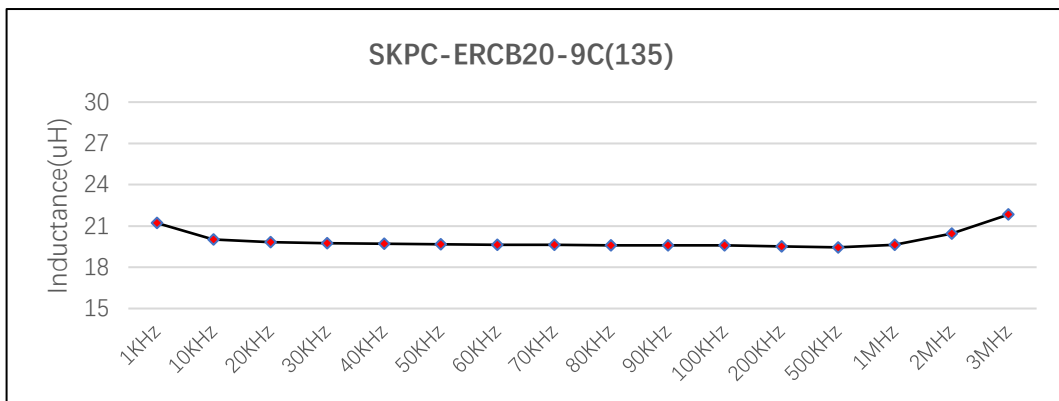
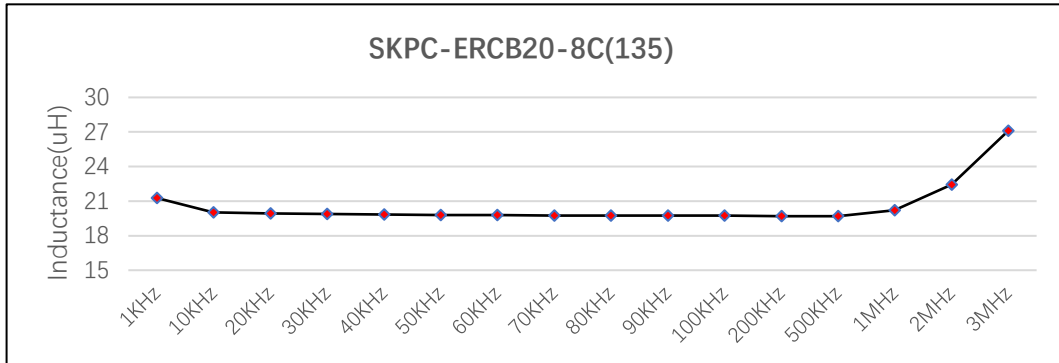

Inductor

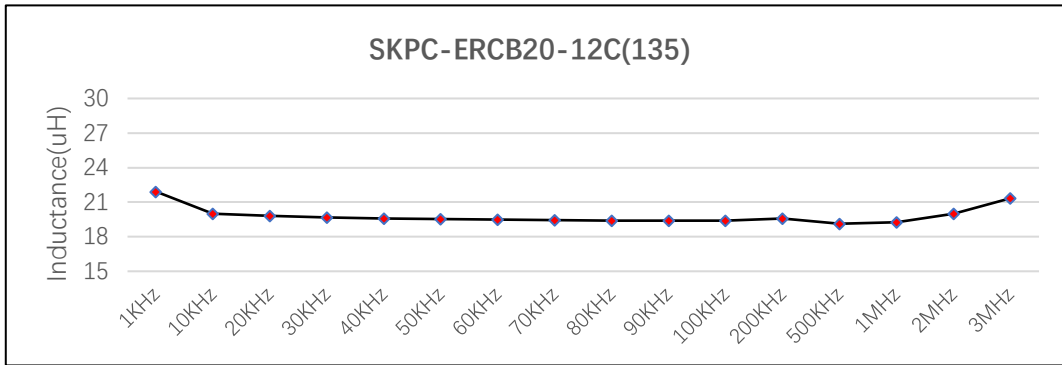

Note: This data is based on the WK-3260B.

L(uH) vs Current(A)

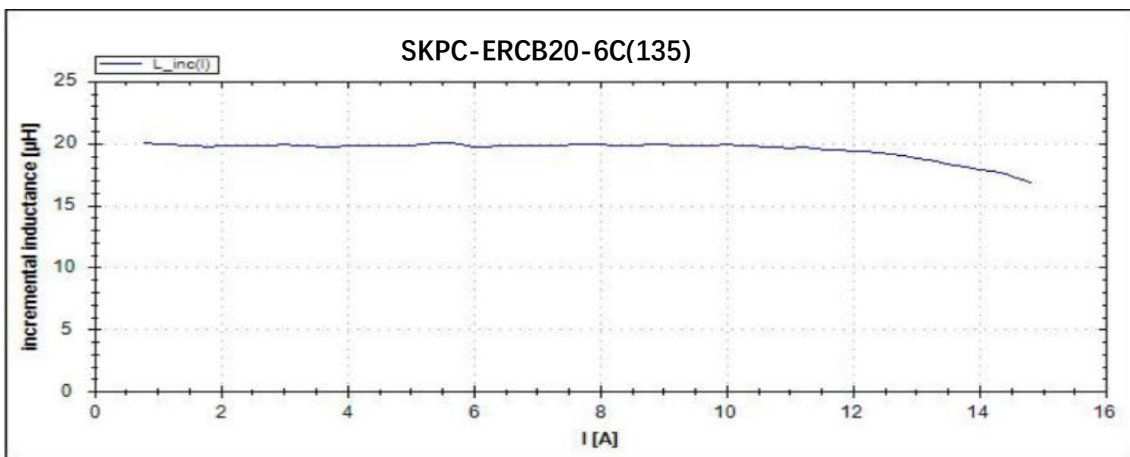
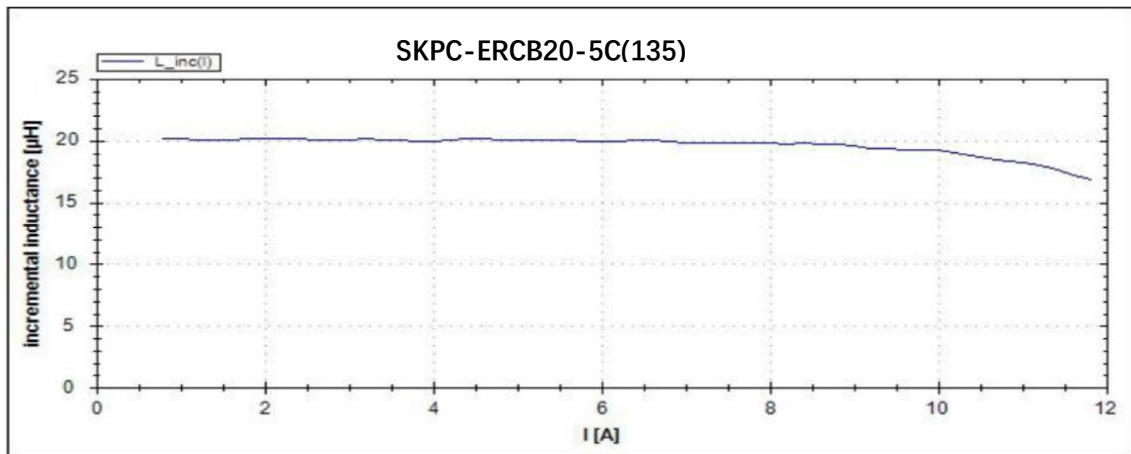

Inductor

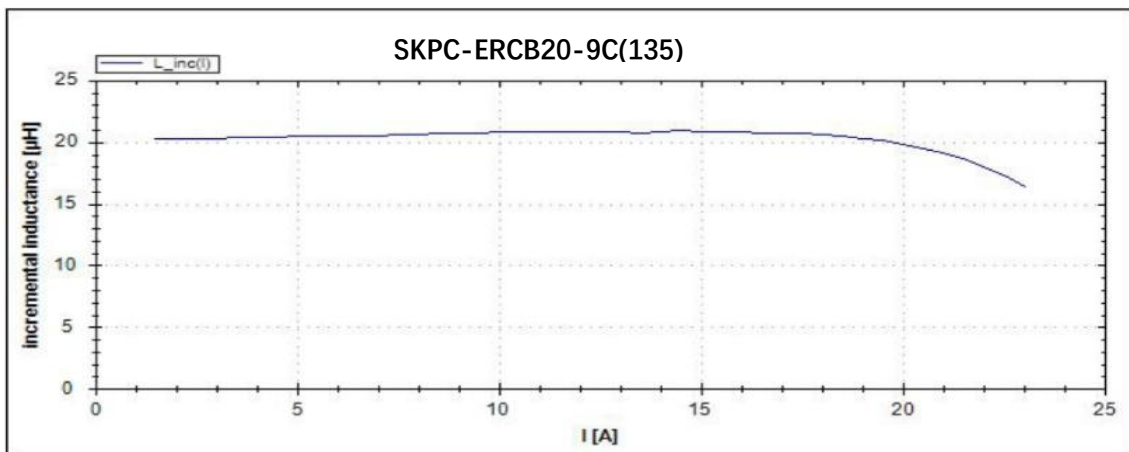
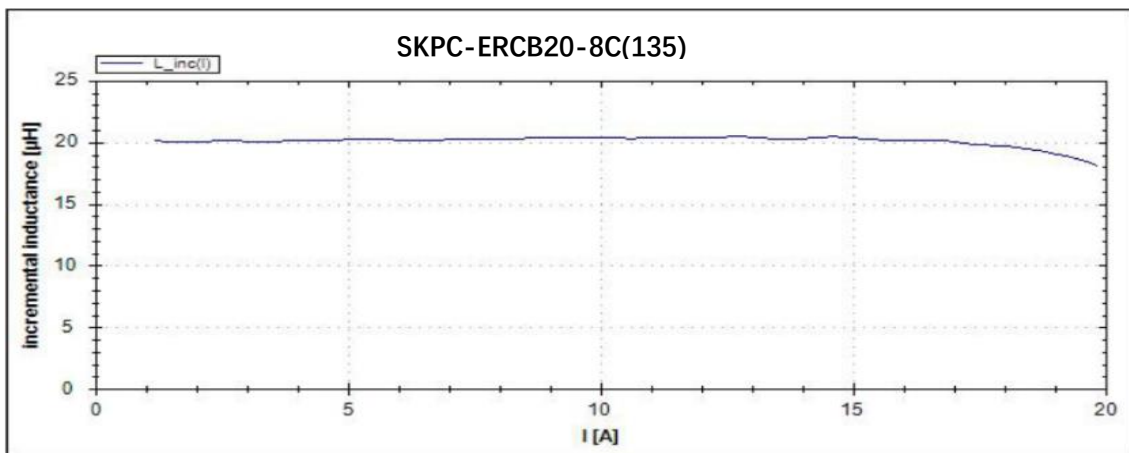
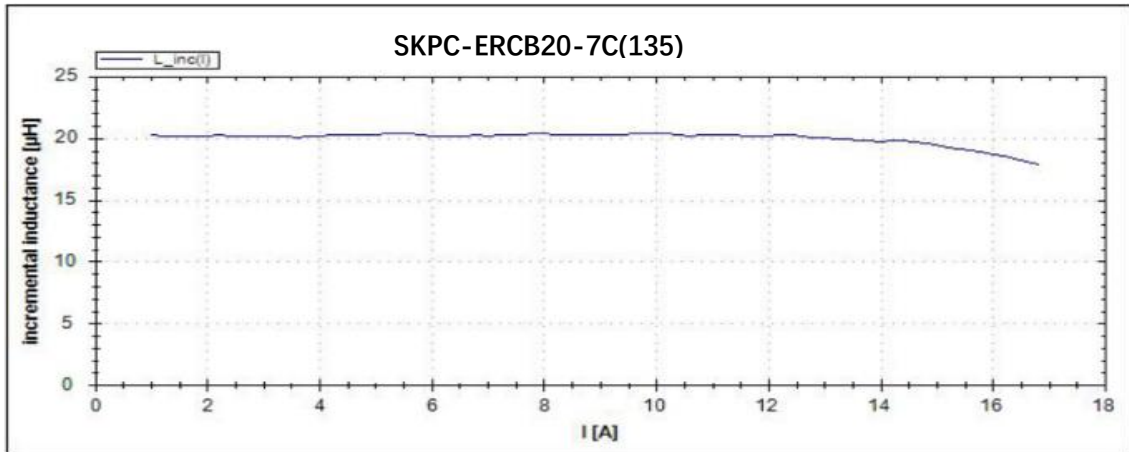

Inductor

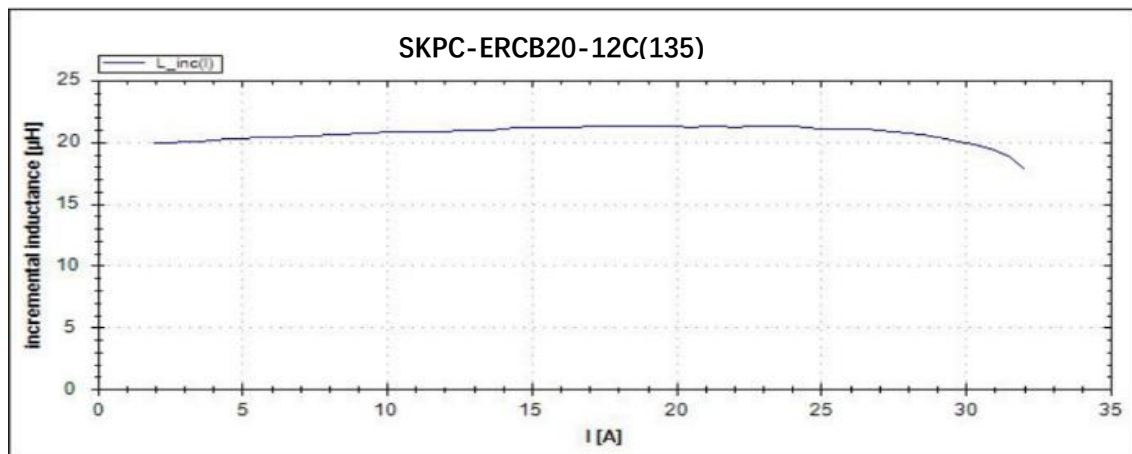
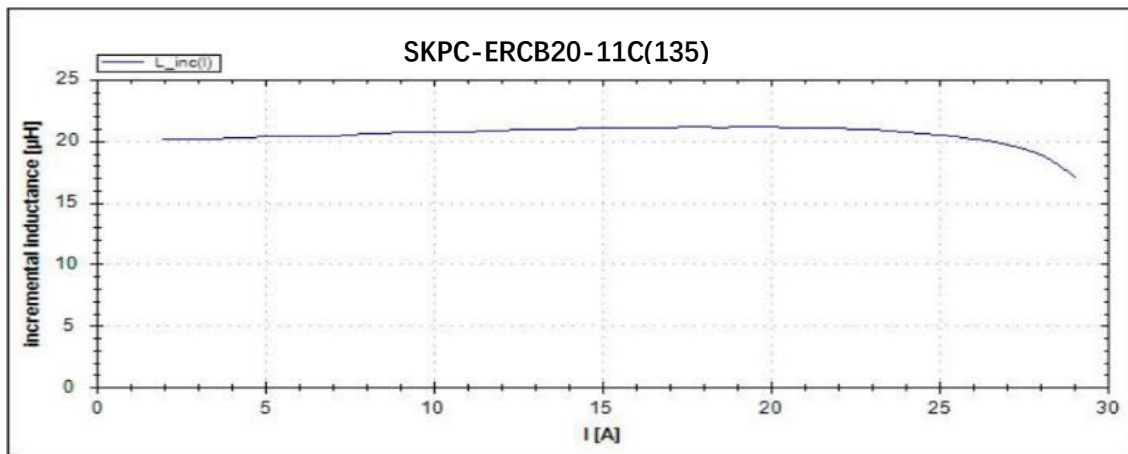
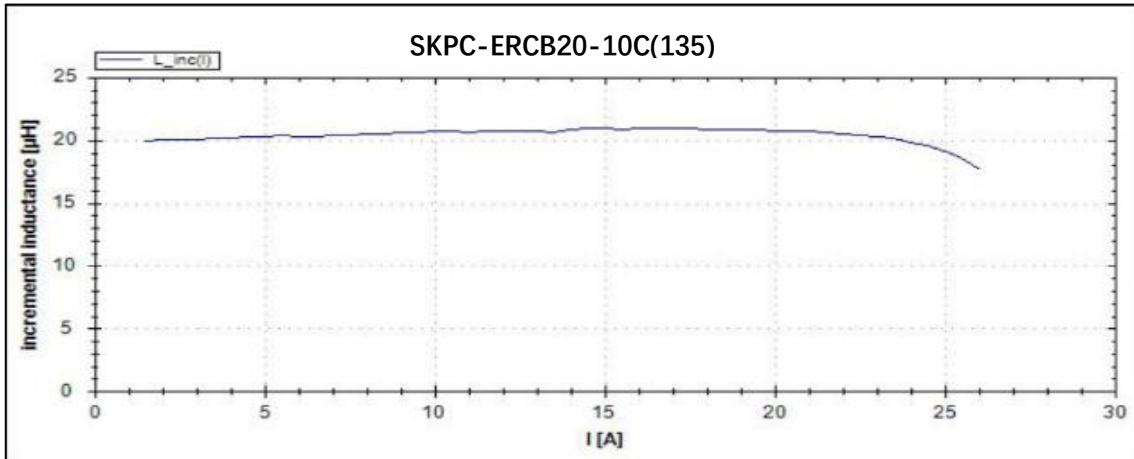

Note: This data is based on the DPG10 Power Choke Tester.