

N-Channel Enhancement Mode Power MOSFET

- Features**

$V_{DS} = 30V,$

$I_D = 83.5A$

$R_{DS(ON)} @ V_{GS} = 10V, TYP 2.5m\Omega$

$R_{DS(ON)} @ V_{GS} = 4.5V, TYP 3.3m\Omega$

- General Description**

- Synchronous Rectification in DC/DC and AC/DC Converters
- Industrial and Motor Drive applications

- Pin Configurations**

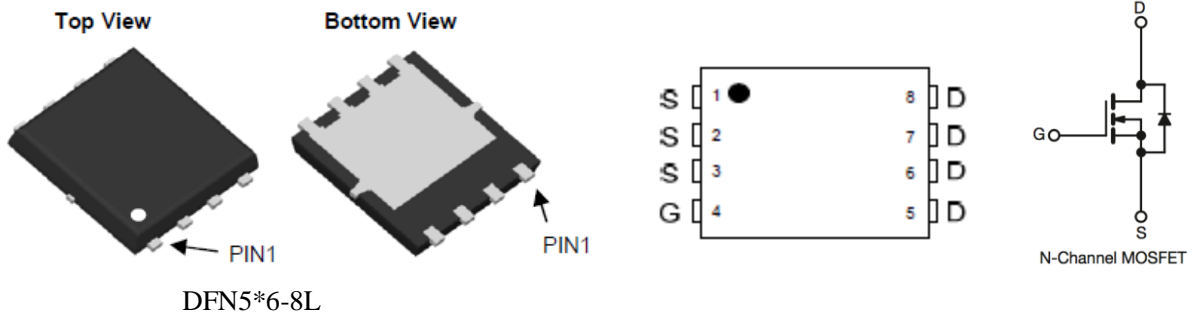

- Absolute Maximum Ratings @ $T_A=25^\circ C$ unless otherwise noted**

Parameter		Symbol	Ratings	Unit
Drain-Source Voltage		V_{DSS}	30	V
Gate-Source Voltage		V_{GSS}	± 20	V
Drain Current (Continuous) *AC	$T_C=25^\circ C$	I_D	83.5	A
	$T_C=70^\circ C$		66	
Drain Current (Pulse) *B		I_{DM}	205	A
Power Dissipation	$T_C=25^\circ C$	P_D	36	W
Operating Temperature/ Storage Temperature		T_J/T_{STG}	-55~150	$^\circ C$

- Thermal Resistance Ratings**

Parameter		Symbol	Typical	Maximum	Unit
Maximum Junction-to-Ambient	$t \leq 10 s$	R_{thJA}	18	22	$^\circ C/W$
Maximum Junction-to-Case (Drain)	Steady State	R_{thJC}	2.8	3.5	

● Electrical Characteristics @ $T_A=25^\circ\text{C}$ unless otherwise noted

Parameter	Symbol	Test Conditions	Min	Typ	Max	Unit
Static						
Drain-Source Breakdown Voltage	$V_{(BR)DSS}$	$V_{GS} = 0V, I_D = 250\mu A$	30	--	--	V
Zero Gate Voltage Drain Current	I_{DSS}	$V_{DS} = 30V, V_{GS} = 0V$	--	--	1	μA
Gate Threshold Voltage	$V_{GS(TH)}$	$V_{GS} = V_{DS}, I_{DS} = 250\mu A$	1	1.6	3	V
Gate Leakage Current	I_{GSS}	$V_{GS} = \pm 20V, V_{DS} = 0V$	--	--	± 100	nA
Drain-Source On-state Resistance	$R_{DS(on)}$	$V_{GS} = 10V, I_D = 20A$	--	2.5	3.3	m Ω
	$R_{DS(on)}$	$V_{GS} = 4.5V, I_D = 10A$	--	3.3	4.3	m Ω
Diode Forward Voltage	V_{SD}	$I_{SD} = 1A, V_{GS} = 0V$	--	0.78	1.2	V
Diode Forward Current *AC	I_S	$T_C = 25^\circ\text{C}$	--	--	46	A
Switching						
Total Gate Charge	Q_g	$V_{DS} = 15V, I_D = 60A,$ $V_{GS} = 10V$	--	63	--	nC
Gate-Source Charge	Q_{gs}		--	10	--	nC
Gate-Drain Charge	Q_{gd}		--	9.5	--	nC
Turn-on Delay Time	$t_{d(on)}$	$V_{DD} = 15V, I_D = 60A$ $V_{GS} = 10V, R_G = 1.6\Omega$	--	9	--	ns
Turn-on Rise Time	t_r		--	4	--	ns
Turn-off Delay Time	$t_{d(off)}$		--	44	--	ns
Turn-Off Fall Time	t_f		--	7	--	ns
Dynamic						
Input Capacitance	C_{iss}	$V_{DS} = 15V, V_{GS} = 0V, f = 1.0\text{MHz}$	--	3550	--	pF
Output Capacitance	C_{oss}		--	950	--	pF
Reverse Transfer Capacitance	C_{rss}		--	63	--	pF

A: The value of $R_{\theta JA}$ is measured with the device mounted on 1in² FR-4 board with 2oz. Copper, in a still air environment with $T_A=25^\circ\text{C}$. The value in any given application depends on the user's specific board design.

B: Repetitive rating, pulse width limited by junction temperature.

C: The current rating is based on the $t \leq 10\text{s}$ junction to ambient thermal resistance rating.

● Typical Performance Characteristics (T_J = 25 °C, unless otherwise noted)

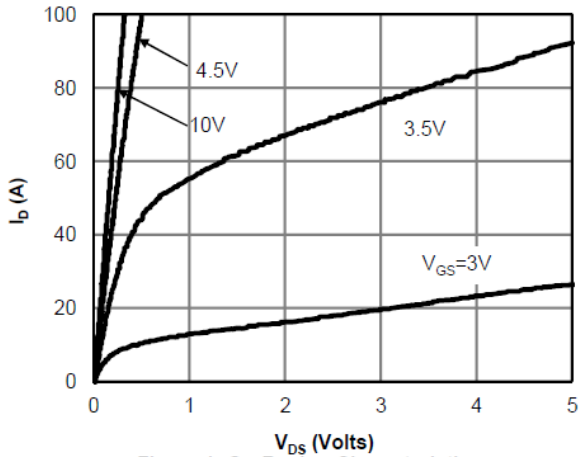

Figure 1: On-Region Characteristics

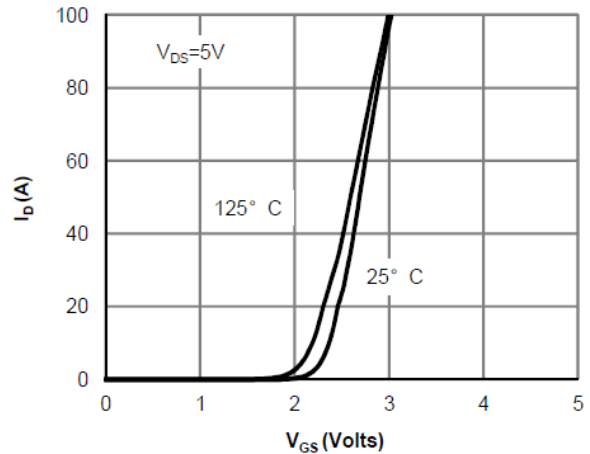

Figure 2: Transfer Characteristics

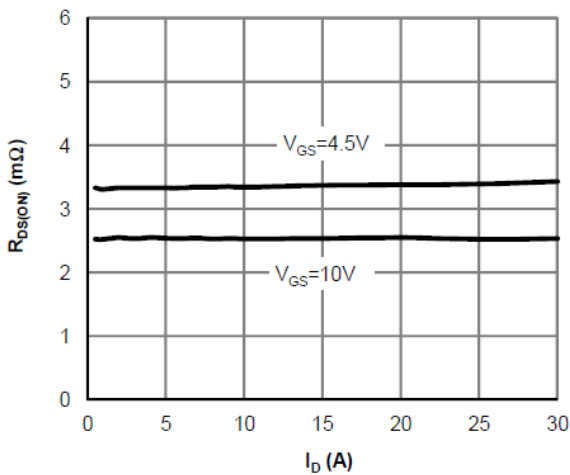

Figure 3: On-Resistance vs. Drain Current and Gate Voltage

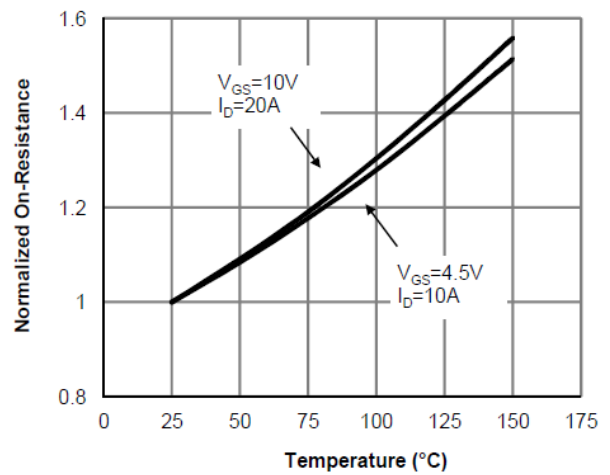

Figure 4: On-Resistance vs. Junction Temperature

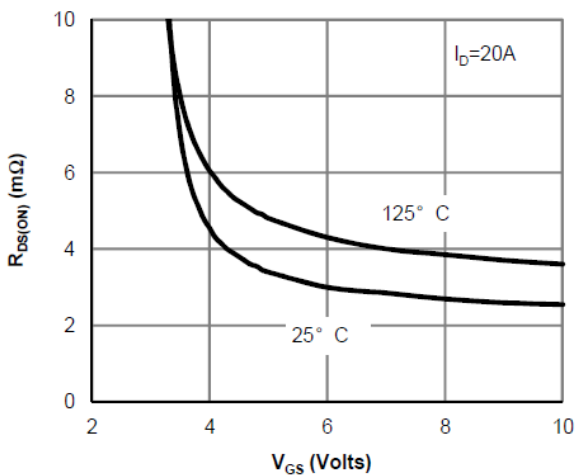

Figure 5: On-Resistance vs. Gate-Source Voltage

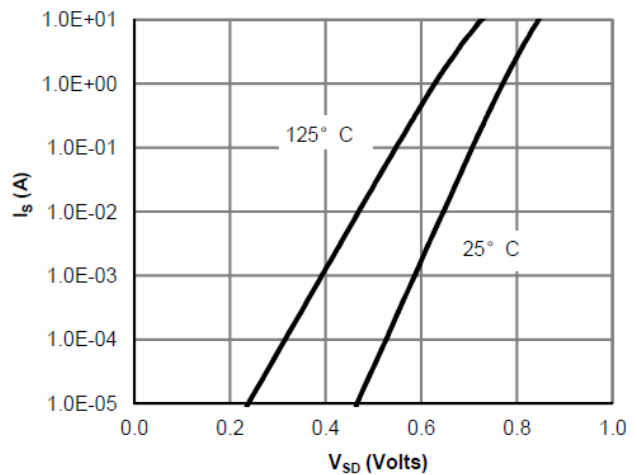

Figure 6: Body-Diode Characteristics

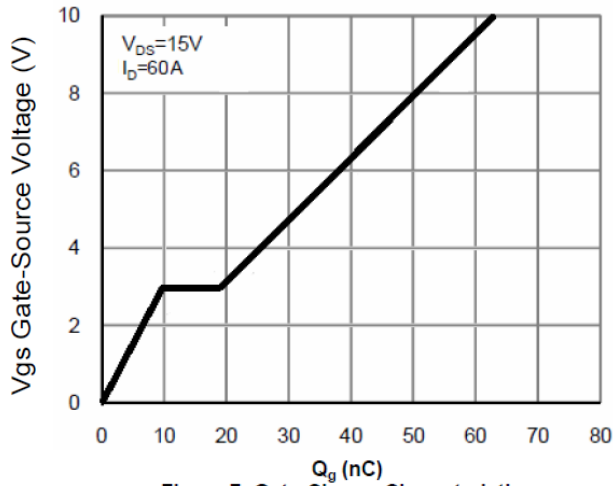

Figure 7: Gate-Charge Characteristics

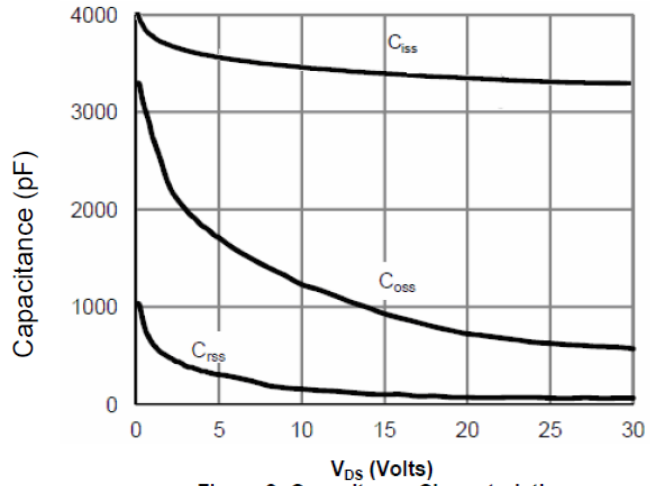

Figure 8: Capacitance Characteristics

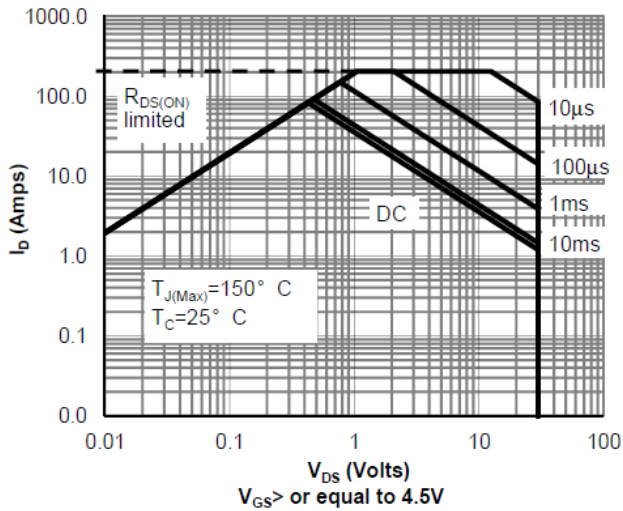

Figure 9: Maximum Forward Biased Safe Operating Area

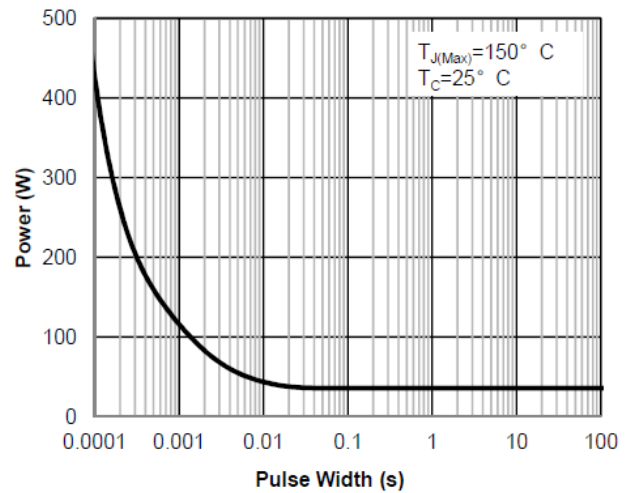

Figure 10: Single Pulse Power Rating Junction-to-Case

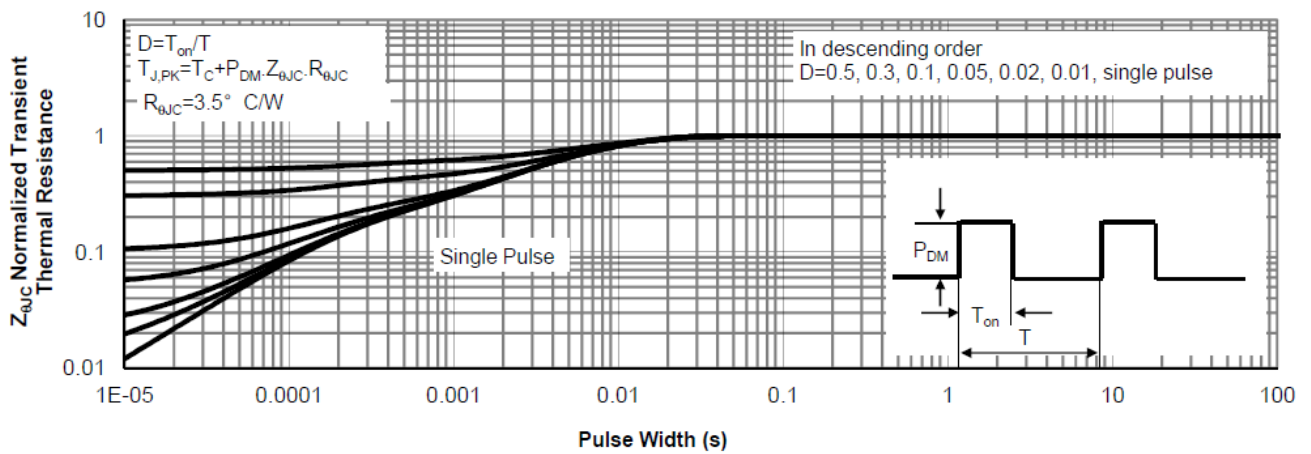
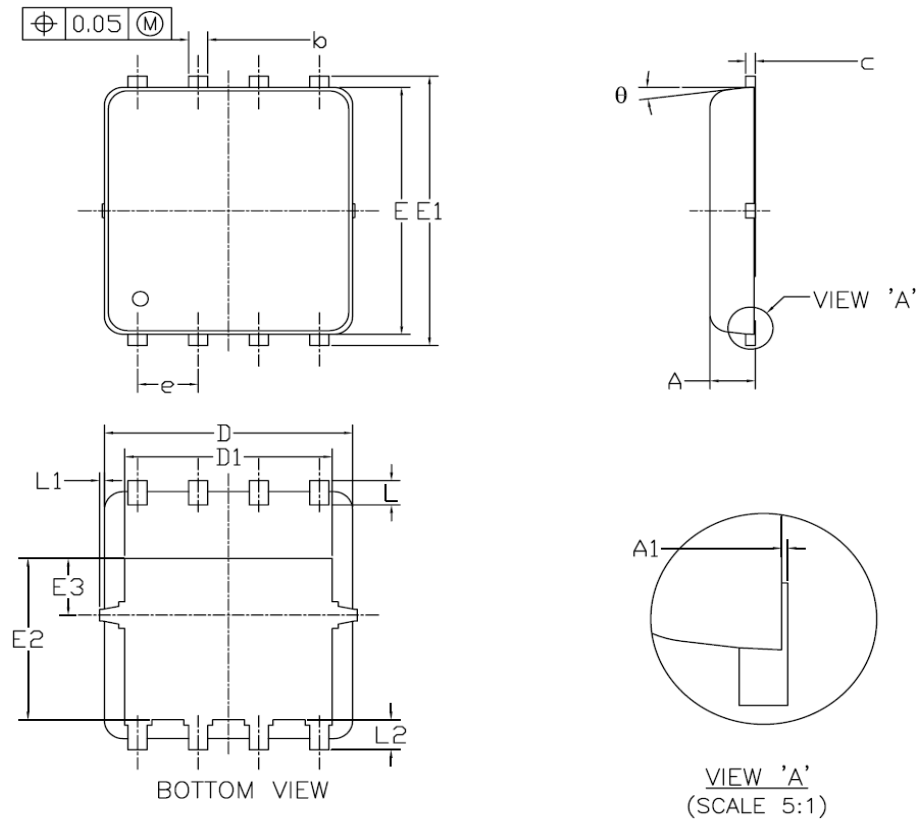
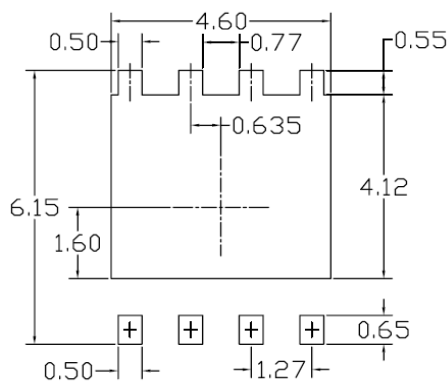

Figure 11: Normalized Maximum Transient Thermal Impedance

● Package Information



RECOMMENDED LAND PATTERN



SYMBOLS	DIMENSIONS IN MILLIMETERS			DIMENSIONS IN INCHES		
	MIN	NOM	MAX	MIN	NOM	MAX
A	0.85	0.95	1.00	0.033	0.037	0.039
A1	0.00	—	0.05	0.000	—	0.002
b	0.30	0.40	0.50	0.012	0.016	0.020
c	0.15	0.20	0.25	0.006	0.008	0.010
D	5.20 BSC			0.205 BSC		
D1	4.35 BSC			0.171 BSC		
E	5.55 BSC			0.219 BSC		
E1	6.05 BSC			0.238 BSC		
E2	3.625 BSC			0.143 BSC		
E3	1.275 BSC			0.050 BSC		
e	1.27 BSC			0.050 BSC		
L	0.45	0.55	0.65	0.018	0.022	0.026
L1	0	—	0.15	0	—	0.006
L2	0.68 REF			0.027 REF		
θ	0°	—	10°	0°	—	10°

UNIT: mm

NOTE

1. PACKAGE BODY SIZES EXCLUDE MOLD FLASH AND GATE BURRS.
MOLD FLASH AT THE NON-LEAD SIDES SHOULD BE LESS THAN 6 MILS EACH.
2. CONTROLLING DIMENSION IS MILLIMETER.
CONVERTED INCH DIMENSIONS ARE NOT NECESSARILY EXACT.