

N-Channel Enhancement Mode Field Effect Transistor

- Features**

$V_{DS} = 20V,$

$I_D = 5.5A$

$R_{DS(ON)} @V_{GS} = 10V, TYP 25m\Omega$

$R_{DS(ON)} @V_{GS} = 4.5V, TYP 27m\Omega$

$R_{DS(ON)} @V_{GS} = 2.5V, TYP 34m\Omega$

- General Description**

- load switch for Portable Applications
- DC/DC Converters

- Pin Configurations**

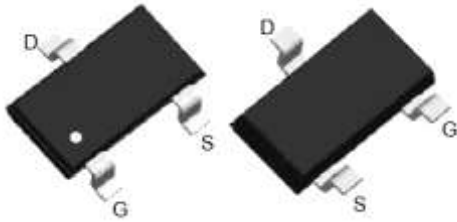

SOT-23

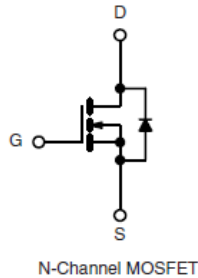

- Absolute Maximum Ratings @ $T_A=25^\circ C$ unless otherwise noted**

Parameter		Symbol	Ratings	Unit
Drain-Source Voltage		V_{DSS}	20	V
Gate-Source Voltage		V_{GSS}	± 12	V
Drain Current (Continuous) *AC	$T_A=25^\circ C$	I_D	5.5	A
	$T_A=70^\circ C$		4	
Drain Current (Pulse) *B		I_{DM}	13.5	A
Power Dissipation	$T_A=25^\circ C$	P_D	1.25	W
Operating Temperature/ Storage Temperature		T_J/T_{STG}	-55~150	$^\circ C$

- Thermal Resistance Ratings**

Parameter		Symbol	Typical	Maximum	Unit
Maximum Junction-to-Ambient ^{a, e}	$t \leq 5s$	R_{thJA}	80	100	$^\circ C/W$

● Electrical Characteristics @ $T_A=25^\circ\text{C}$ unless otherwise noted

Parameter	Symbol	Test Conditions	Min	Typ	Max	Unit
Static						
Drain-Source Breakdown Voltage	$V_{(BR)DSS}$	$V_{GS} = 0V, I_D = 250\mu A$	20	--	--	V
Zero Gate Voltage Drain Current	I_{DSS}	$V_{DS} = 20V, V_{GS} = 0V$	--	--	1	μA
Gate Threshold Voltage	$V_{GS(TH)}$	$V_{GS} = V_{DS}, I_{DS} = 250\mu A$	0.4	0.66	1.2	V
Gate Leakage Current	I_{GSS}	$V_{GS} = \pm 12V, V_{DS} = 0V$	--	--	± 100	nA
Drain-Source On-state Resistance	$R_{DS(on)}$	$V_{GS} = 10V, I_D = 5A$	--	25	30	m Ω
	$R_{DS(on)}$	$V_{GS} = 4.5V, I_D = 4.5A$	--	27	33	m Ω
	$R_{DS(on)}$	$V_{GS} = 2.5V, I_D = 4A$	--	34	42	m Ω
Forward Transconductance	g_{FS}	$V_{DS} = 10V, I_D = 5A$	--	10	--	S
Diode Forward Voltage	V_{SD}	$I_{SD} = 1A, V_{GS} = 0V$	--	--	1.2	V
Diode Forward Current	I_S	$T_C = 25^\circ\text{C}$	--	--	2	A
Switching						
Total Gate Charge	Q_g	$V_{GS} = 4.5V, V_{DS} = 10V, I_D = 5A$	--	10	--	nC
Gate-Source Charge	Q_{gs}		--	2.3	--	nC
Gate-Drain Charge	Q_{gd}		--	2.9	--	nC
Turn-on Delay Time	$t_{d(on)}$	$V_{DD} = 10V, R_G = 6\Omega$ $I_D = 1A, V_{GS} = 4.5V$	--	18	--	ns
Turn-on Rise Time	t_r		--	11	--	ns
Turn-off Delay Time	$t_{d(off)}$		--	36.7	--	ns
Turn-Off Fall Time	t_f		--	48	--	ns
Dynamic						
Input Capacitance	C_{iss}	$V_{GS} = 0V, V_{DS} = 8V, f = 1.0\text{MHz}$	--	500	--	pF
Output Capacitance	C_{oss}		--	300	--	pF
Reverse Transfer Capacitance	C_{rss}		--	140	--	pF

A: The value of $R_{\theta JA}$ is measured with the device mounted on 1in² FR-4 board with 2oz. Copper, in a still air environment with $T_A=25^\circ\text{C}$. The value in any given application depends on the user's specific board design.

B: Repetitive rating, pulse width limited by junction temperature.

C: The current rating is based on the $t \leq 10s$ junction to ambient thermal resistance rating.

● Typical Performance Characteristics ((T_J = 25 °C, unless otherwise noted))

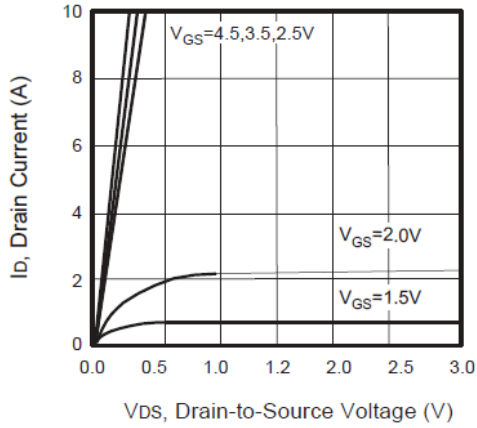

Figure 1. Output Characteristics

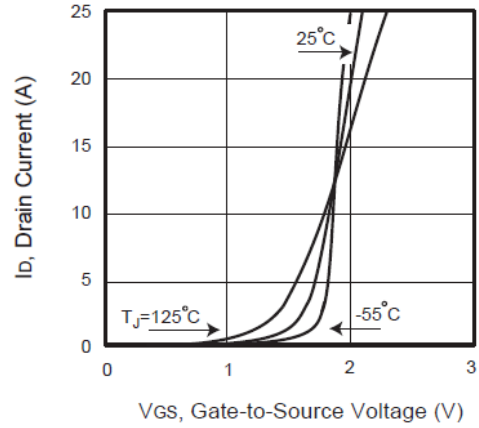

Figure 2. Transfer Characteristics

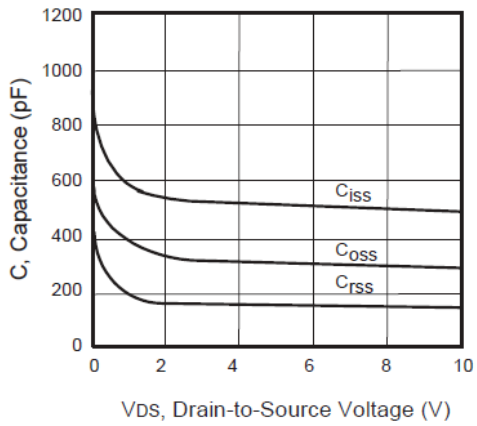

Figure 3. Capacitance

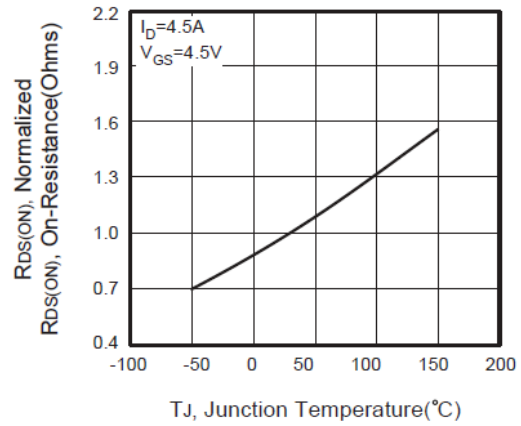

Figure 4. On-Resistance Variation with Temperature

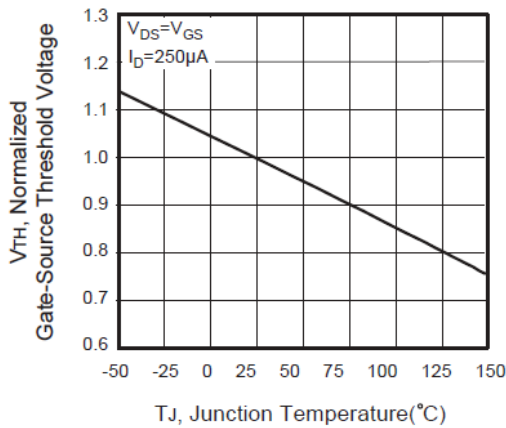

Figure 5. Gate Threshold Variation with Temperature

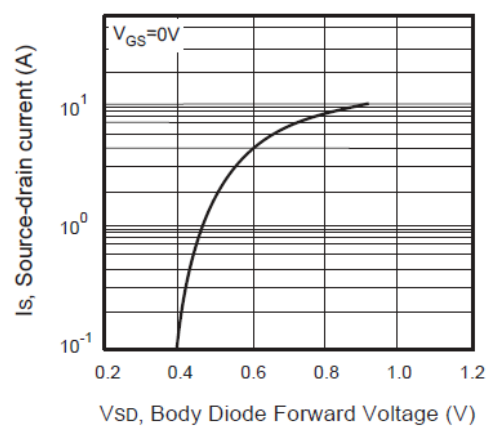

Figure 6. Body Diode Forward Voltage Variation with Source Current

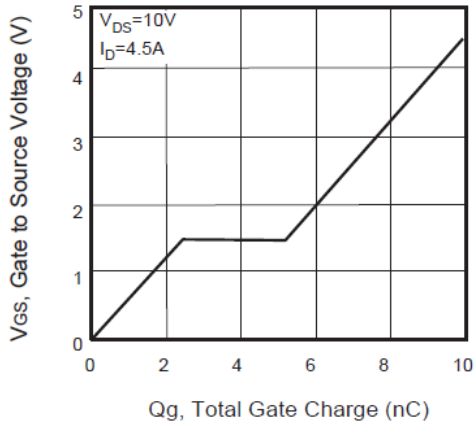

Figure 7. Gate Charge

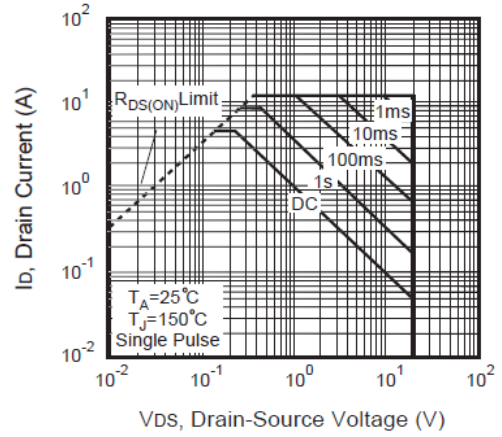

Figure 8. Maximum Safe Operating Area

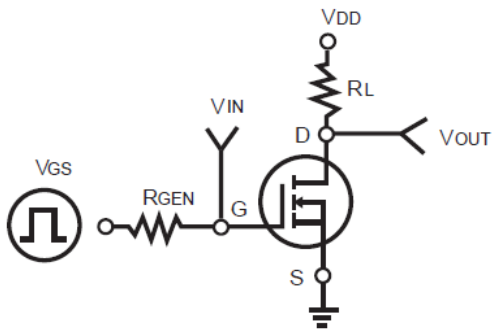

Figure 9. Switching Test Circuit

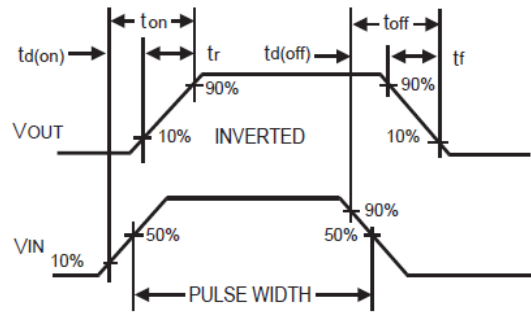

Figure 10. Switching Waveforms

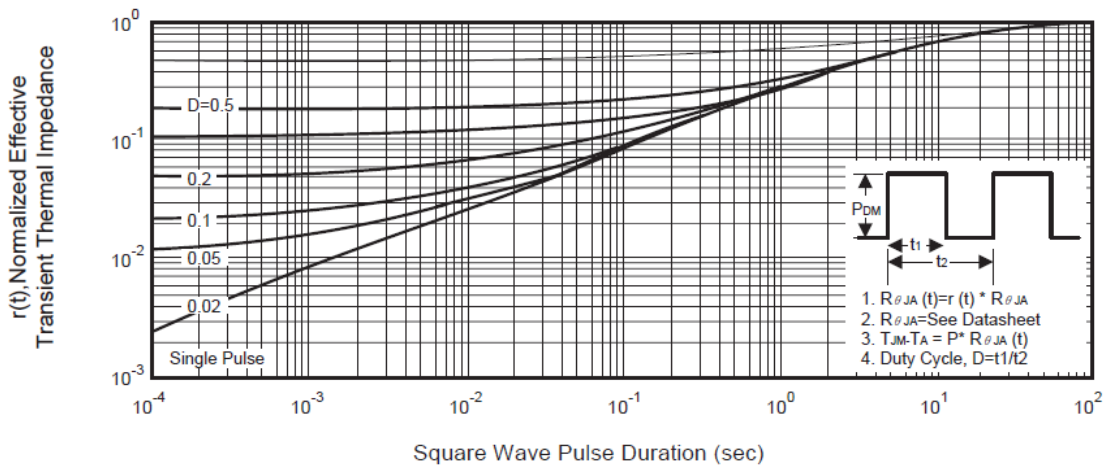
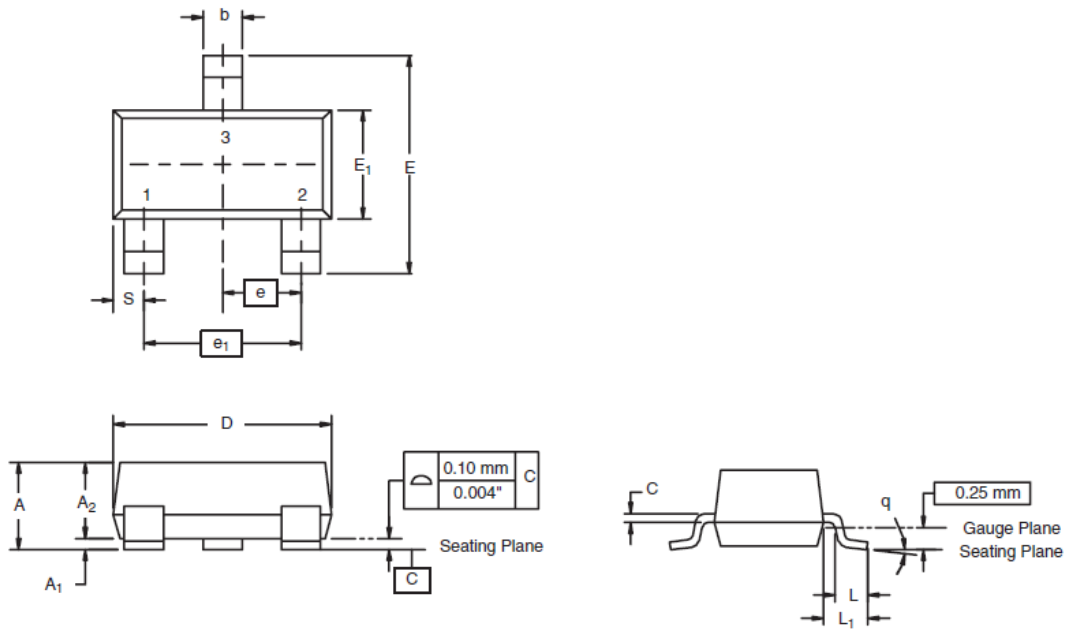

Figure 11. Normalized Thermal Transient Impedance Curve

● Package Information



Dim	MILLIMETERS		INCHES	
	Min	Max	Min	Max
A	0.89	1.12	0.035	0.044
A ₁	0.01	0.10	0.0004	0.004
A ₂	0.88	1.02	0.0346	0.040
b	0.35	0.50	0.014	0.020
c	0.085	0.18	0.003	0.007
D	2.80	3.04	0.110	0.120
E	2.10	2.64	0.083	0.104
E ₁	1.20	1.40	0.047	0.055
e	0.95 BSC		0.0374 Ref	
e ₁	1.90 BSC		0.0748 Ref	
L	0.40	0.60	0.016	0.024
L ₁	0.64 Ref		0.025 Ref	
S	0.50 Ref		0.020 Ref	
q	3°	8°	3°	8°