

## Features

- ◆ 180W peak pulse power(8/20 $\mu$ s)
- ◆ Ultra low leakage: nA level
- ◆ Operating voltage: 24V
- ◆ Low clamping voltage
- ◆ Complies with following standards:
  - IEC 61000-4-2 (ESD) immunity test
    - Air discharge:  $\pm$ 30kV
    - Contact discharge:  $\pm$ 30kV
  - IEC61000-4-4 (EFT) 40A (5/50ns)
  - IEC61000-4-5 (Lightning) 3.5A(8/20 $\mu$ s)
- ◆ RoHS Compliant

## Mechanical Characteristics

- ◆ Package: SOT-23
- ◆ Lead Finish: Matte Tin
- ◆ Case Material: “Green” Molding Compound.
- ◆ UL Flammability Classification Rating 94V-0
- ◆ Moisture Sensitivity: Level 3 per J STD 020
- ◆ Shipping Qty :3000pcs/7Inch Tape & Reel

## Applications

- ◆ CAN Bus Protection
- ◆ Automotive Appllcatrons

## Dimensions and Pin Configuration

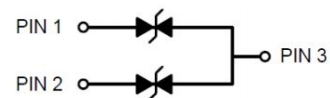

**Absolute Maximum Ratings** (T amb=25°C unless otherwise specified)

Parameter	Symbol	Value	Unit
Peak Pulse Power(8/20μs)	Ppk	180	W
ESD per IEC 61000-4-2 (Air)	VESD	±15	kV
ESD per IEC 61000-4-2 (Contact)		±8	
Operating Temperature Range	TJ	-55 to +125	°C
Storage Temperature Range	Tstg	-55 to +150	°C

**Electrical Characteristics** (TA=25°C unless otherwise specified)

Parameter	Symbol	Min	Typ	Max	Unit	Test Condition
Reverse Working Voltage	VRWM			24	V	
Breakdown Voltage	VBR	26.7			V	IT = 1mA
Reverse Leakage Current	IR		0.01	0.1	μA	VRWM = 24V
Clamping Voltage	VC			24	V	I <sub>PP</sub> = 1A (8 x 20μs pulse)
Clamping Voltage	VC			65	V	I <sub>PP</sub> = 3.5 A (8 x 20μs pulse)
Peak Pulse Current	I <sub>PP</sub>			3.5	A	t <sub>p</sub> =8/20μs
Junction Capacitance	CJ		12	14	pF	VR=0, f=1MHz, Pin 1 to Pin 3 or Pin 2 to Pin 3

**Typical Performance Characteristics ( $T_A=25^\circ\text{C}$  unless otherwise Specified)**

Fig1. 8/20 $\mu\text{s}$  Pulse Waveform

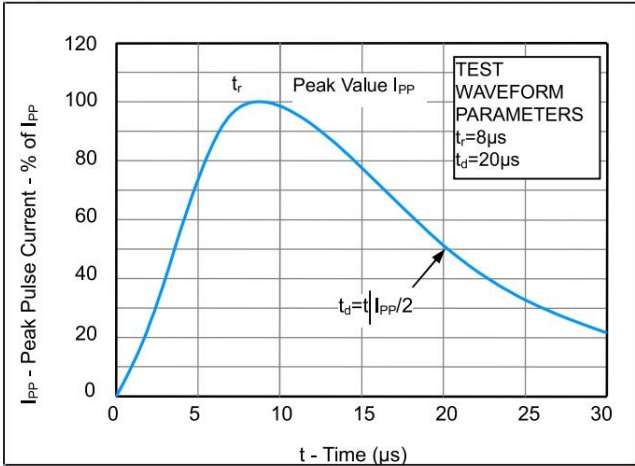

Fig2. ESD Pulse Waveform (according to IEC 61000-4-2)

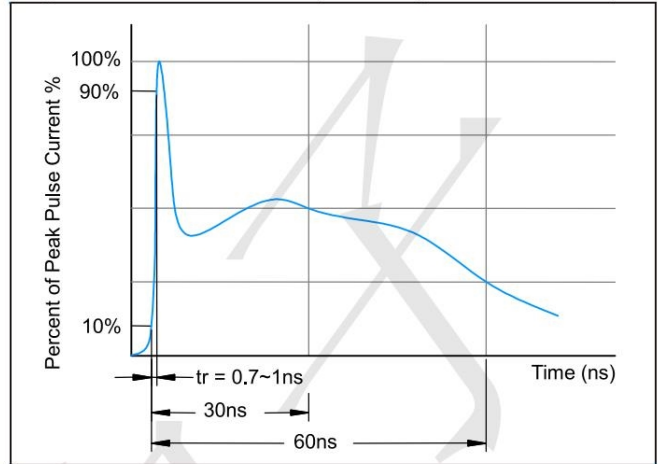
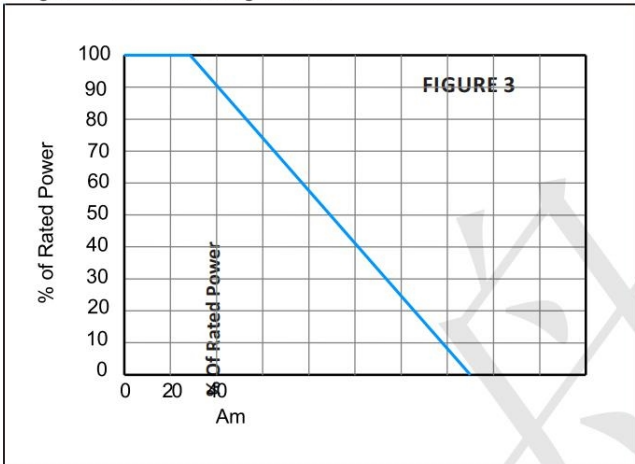
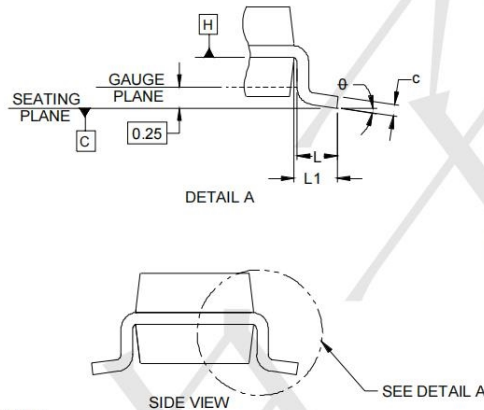
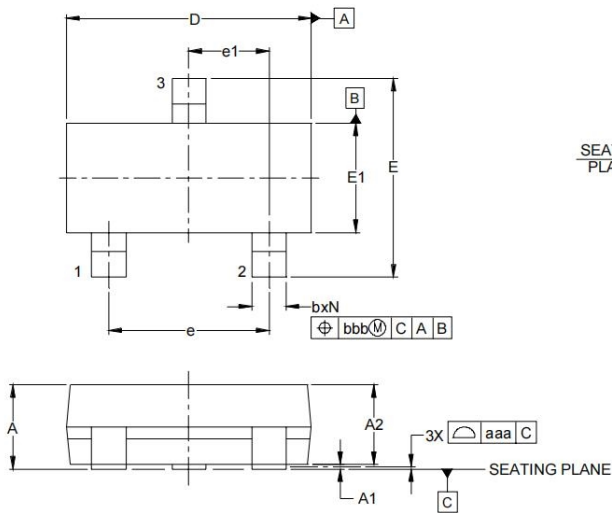

Fig3. Power Derating Curve



## Outline Drawing - SOT23



DIM	INCHES			MILLIMETERS		
	MIN	NOM	MAX	MIN	NOM	MAX
A	.035	-	.044	0.89	-	1.12
A1	.000	-	.004	0.01	-	0.10
A2	.035	.037	.040	0.88	0.95	1.02
b	.012	-	.020	0.30	-	0.51
c	.003	-	.007	0.08	-	0.18
D	.110	.114	.120	2.80	2.90	3.04
E	.082	.093	.104	2.10	2.37	2.64
E1	.047	.051	.055	1.20	1.30	1.40
e	.075			1.90 BSC		
e1	.037			0.95 BSC		
L	.015	.020	.024	0.40	0.50	0.60
L1	.022			(0.55)		
N	3			3		
θ	0°	-	8°	0°	-	8°
aaa	.004			0.10		
bbb	.008			0.20		

## Land Pattern - SOT23

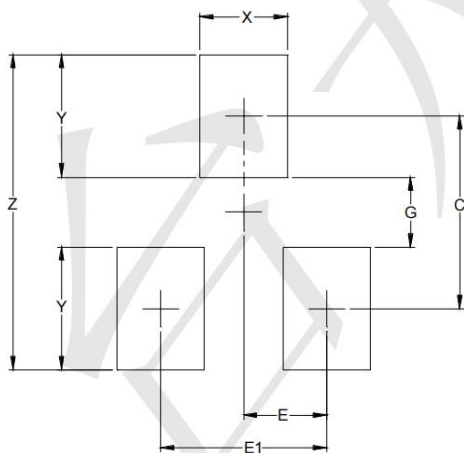

DIMENSIONS		
DIM	INCHES	MILLIMETERS
C	(.087)	(2.20)
E	.037	0.95
E1	.075	1.90
G	.031	0.80
X	.039	1.00
Y	.055	1.40
Z	.141	3.60