

SS32BF~SS320BF

Rev.E May.-2019

描述 / Descriptions

表面贴装肖特基二极管，反向电压：20V~200V，正向电流：3.0A，薄型 SMBF 封装。

Surface Mount Schottky Barrier Rectifier, Reverse Voltage: 20 to 200V, Forward Current: 3.0A, SMBF thin package.

特征 / Features

低功耗，高效率，浪涌电流大，适用于低压、高频转换和极性保护，适用于表面贴装。无卤产品。

Low power loss, high efficiency, High forward surge current capability, For use in low voltage, high frequency inverters, and polarity protection applications, For surface mounted applications. Halogen free product.

用途 / Applications

一般用途。

General purpose.

内部等效电路 / Equivalent Circuit



引脚排列 / Pinning

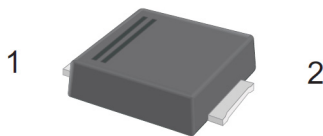

PIN	DESCRIPTION
1	Cathode
2	Anode

The recommended mounting pad size

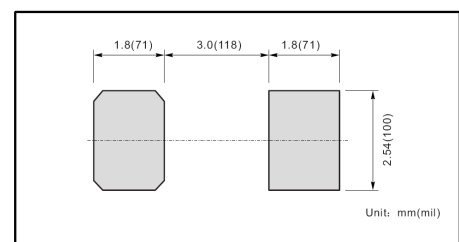

印章代码 / Marking

见印章说明。See Marking Instructions.

极限参数 / Absolute Maximum Ratings(Ta=25°C)

参数 Parameter	参数符号 Symbol	数值 Rating								单位 Unit
		SS32BF	SS34BF	SS36BF	SS38BF	SS310BF	SS312BF	SS315BF	SS320BF	
Maximum Repetitive Peak Reverse Voltage	V _{RRM}	20	40	60	80	100	120	150	200	V
Maximum RMS voltage	V _{RMS}	14	28	42	56	70	84	105	140	V
Maximum DC Blocking Voltage	V _{DC}	20	40	60	80	100	120	150	200	V
Maximum Average Forward Rectified Current	I _{F(AV)}	3.0								A
Peak Forward Surge Current,8.3ms Single Half Sine-wave Superimposed on Rated Load (JEDEC method)	I _{FSM}	80				70				A
Typical Junction Capacitance ¹⁾	C _j	450			400					pF
Typical Thermal Resistance ²⁾	R _{θJA}	50								°C/W
Operating Junction Temperature Range	T _j	-55~+125								°C
Storage Temperature Range	T _{stg}	-55~+150								°C

Note:

- 1) Measured at 1MHz and applied reverse voltage of 4 V D.C.
- 2) P.C.B. mounted with 0.5 X 0.5" (12.7 X 12.7 mm) copper pad areas.

电性能参数 / Electrical Characteristics(Ta=25°C)

参数 Parameter	参数符号 Symbol	测试条件 Test condition	数值 Rating								单位 Unit
			SS32BF	SS34BF	SS36BF	SS38BF	SS310BF	SS312BF	SS315BF	SS320BF	
Max Instantaneous Forward Voltage	V _F	I _F =3.0A	0.55		0.70		0.85		0.95		V
Maximum DC Reverse Current at Rated DC Reverse Voltage	I _R	T _a =25°C	0.5			0.3					mA
		T _a =100°C	5.0			3.0					

电参数曲线图 / Electrical Characteristic Curve

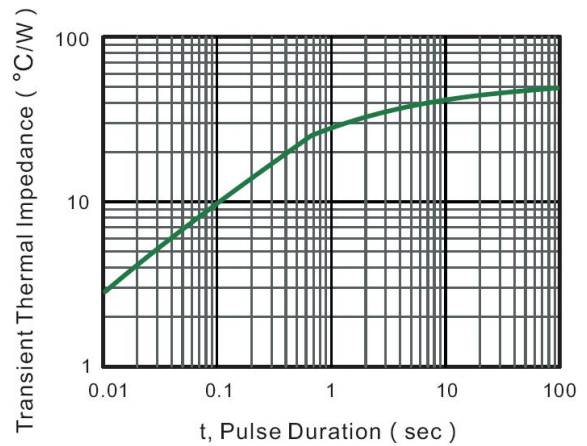
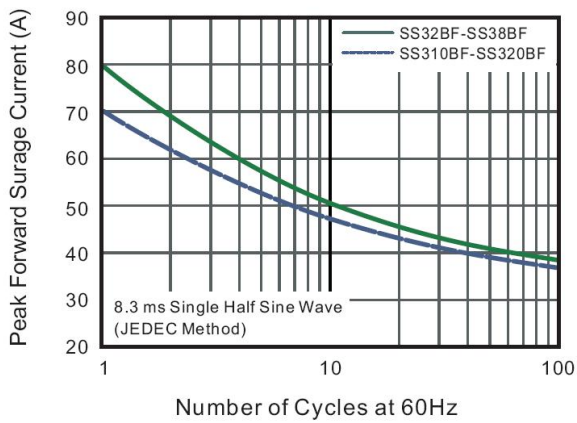
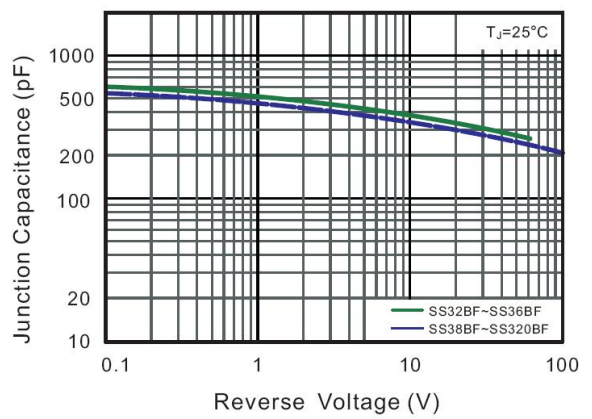
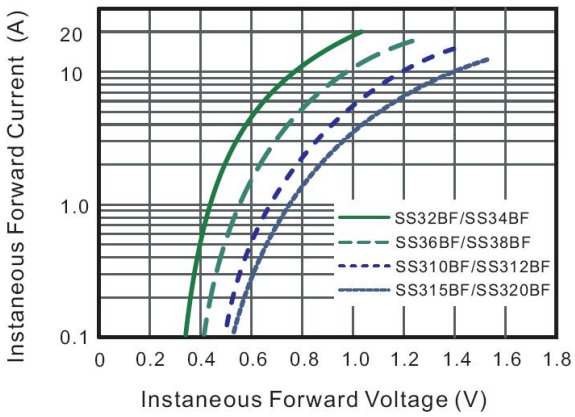
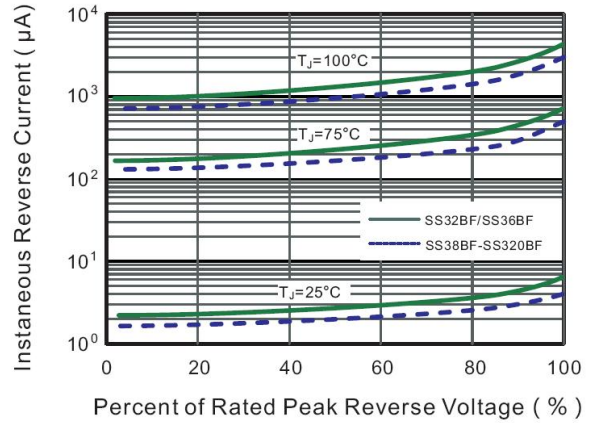
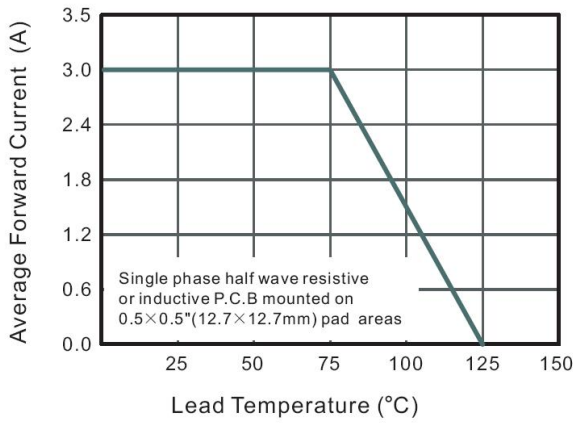

外形尺寸图 / Package Dimensions

SMBF

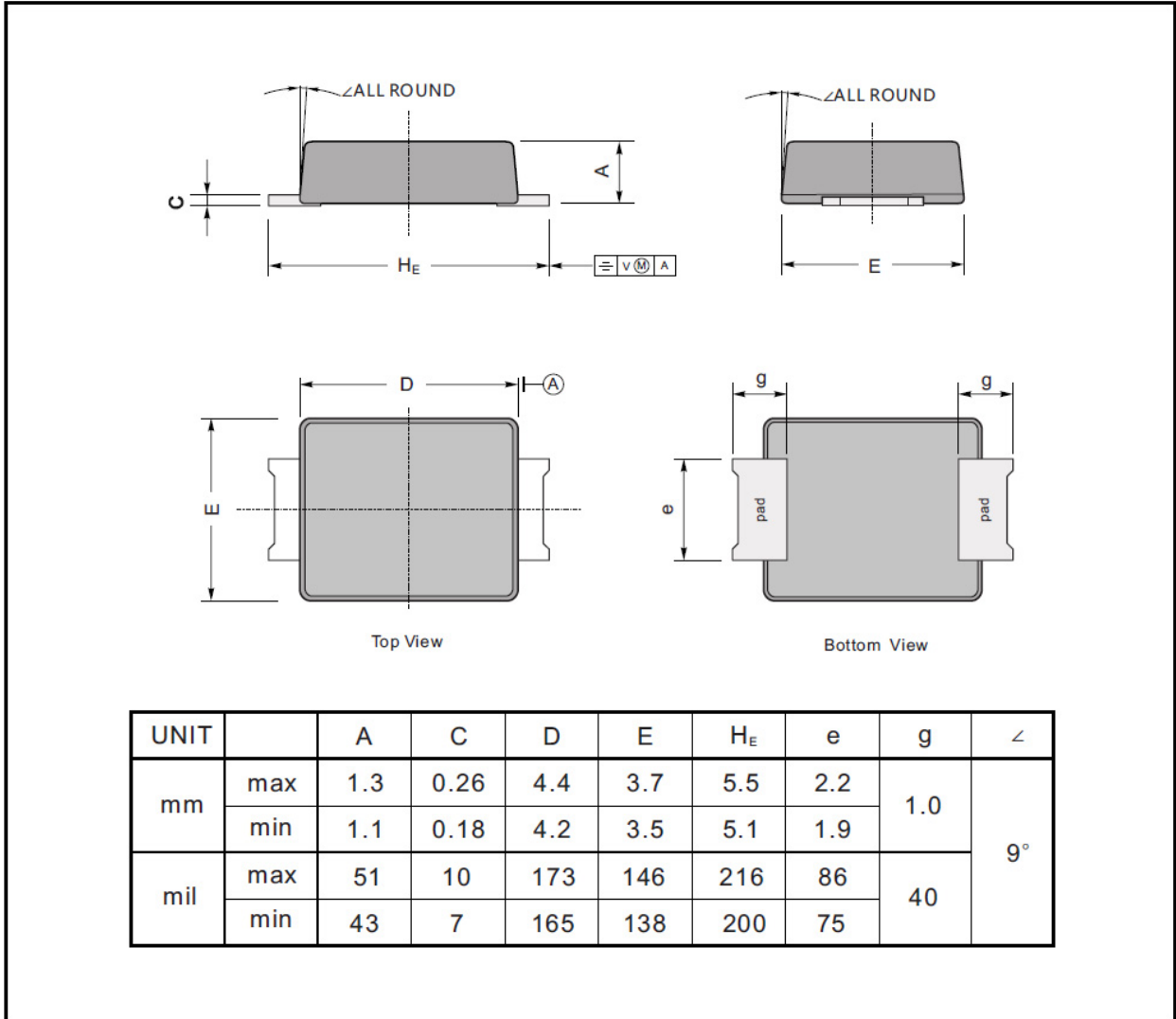

Marking

Type number	Marking code
SS32BF	S32B
SS34BF	S34B
SS36BF	S36B
SS38BF	S38B
SS310BF	S310B
SS312BF	S312B
SS315BF	S315B
SS320BF	S320B

印章说明 / Marking Instructions

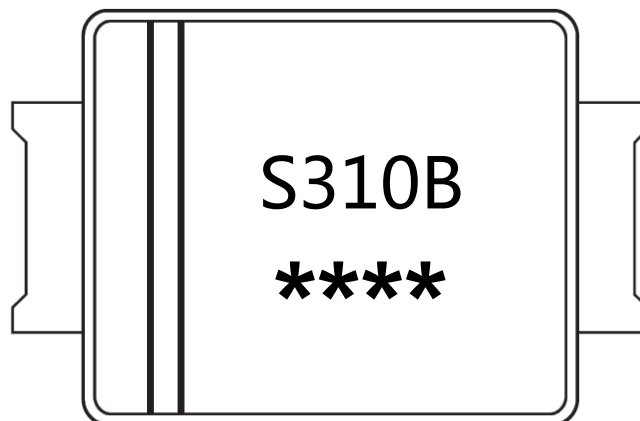

说明：

S310B： 为型号代码

****： 为生产批号追溯码，第1个*为年月代码，后面3个*为当月小批号代码

Note:

S310B： Product Type Code

****： Lot No. Code , The 1st * means:YM Code , The last 3 * means:little Lot No Code

回流焊温度曲线图(无铅) / Temperature Profile for IR Reflow Soldering(Pb-Free)

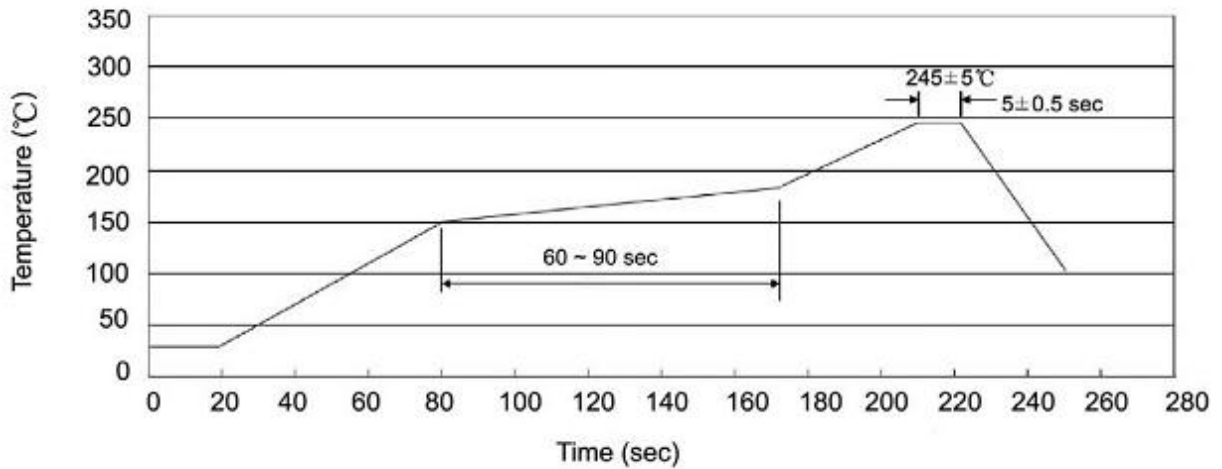

说明：

- 1、预热温度 150 ~ 180°C，时间 60 ~ 90sec；
- 2、峰值温度 245±5°C，时间持续为 5±0.5sec；
- 3、焊接制程冷却速度为 2 ~ 10°C/sec.

Note:

- 1.Preheating:150~180°C, Time:60~90sec.
- 2.Peak Temp.:245±5°C, Duration:5±0.5sec.
3. Cooling Speed: 2~10°C/sec.

耐焊接热试验条件 / Resistance to Soldering Heat Test Conditions

温度：260±5°C

时间：10±1 sec.

Temp.:260±5°C

Time:10±1 sec

包装规格 / Packaging SPEC.

卷盘包装 / REEL

Package Type 封装形式	Units 包装数量					Dimension 包装尺寸 (unit: mm ³)		
	Units/Reel 只/卷盘	Reels/Inner Box 卷盘/盒	Units/Inner Box 只/盒	Inner Boxes/Outer Box 盒/箱	Units/Outer Box 只/箱	Reel	Inner Box 盒	Outer Box 箱
SMBF	5000	2	10000	5	50000	13" ×15	336X332X40	380X335X366

使用说明 / Notices