

SS22BF~SS220BF

Rev. B May.-2019

描述 / Descriptions

表面贴装肖特基整流二极管，反向电压：20~200V，正向电流：2.0A，SMBF 封装。

Surface Mount Schottky Barrier Rectifier, Reverse Voltage:20 to 200 V, Forward Current:2.0A, SMBF package.

特征 / Features

低功耗，效率高，浪涌电流大，适用于低压高频逆变器和极性保护，适用于表面贴装。无卤产品。

Low power loss, high efficiency, High forward surge current capability, For use in low voltage, high frequency inverters, and polarity protection applications, For surface mounted applications. Halogen free product.

用途 / Applications

一般用途。

General purpose.

内部等效电路 / Equivalent Circuit



引脚排列 / Pinning

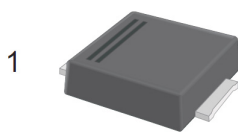

2

PIN	DESCRIPTION
1	Cathode
2	Anode

The recommended mounting pad size

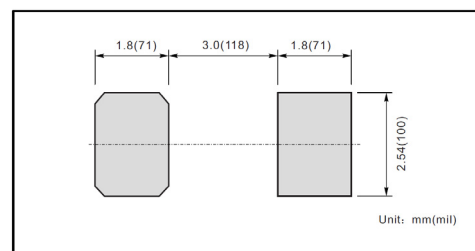

印章代码 / Marking

见印章说明。See Marking Instructions.

极限参数 / Absolute Maximum Ratings(Ta=25°C)

参数 Parameter	符号 Symbol	数值 Rating								单位 Unit
		SS22BF	SS24BF	SS26BF	SS28BF	SS210BF	SS212BF	SS215BF	SS220BF	
Maximum Repetitive Peak Reverse Voltage	V _{RRM}	20	40	60	80	100	120	150	200	V
Maximum RMS voltage	V _{RMS}	14	28	42	56	70	84	105	140	V
Maximum DC Blocking Voltage	V _{DC}	20	40	60	80	100	120	150	200	V
Maximum Average Forward Rectified Current	I _{F(AV)}	2.0								A
Peak Forward Surge Current,8.3ms Single Half Sine-wave Superimposed on Rated Load (JEDEC method)	I _{FSM}	50								A
Typical Junction Capacitance ¹⁾	C _j	220			110					pF
Typical Thermal Resistance ²⁾	R _{θJA}	75								°C/W
Operating Junction Temperature Range	T _j	-55~+125								°C
Storage Temperature Range	T _{stg}	-55~+150								°C

Note:

- 1) Measured at 1MHz and applied reverse voltage of 4 V D.C.
- 2) P.C.B. mounted with 2.0 X 2.0" (5 X 5 cm) copper pad areas.

电性能参数 / Electrical Characteristics(Ta=25°C)

参数 Parameter	符号 Symbol	测试条件 Test Conditions	数值 Rating							单位 Unit	
			SS22BF	SS24BF	SS26BF	SS28BF	SS210BF	SS212BF	SS215BF		SS220BF
Max Instantaneous Forward Voltage	V _F	I _F =2.0A	0.55		0.70		0.85		0.95		V
Maximum DC Reverse Current at Rated DC Reverse Voltage	I _R	T _a =25°C	0.5			0.3					mA
		T _a =100°C	5.0			3					

电参数曲线图 / Electrical Characteristic Curve

Fig.1 Forward Current Derating Curve

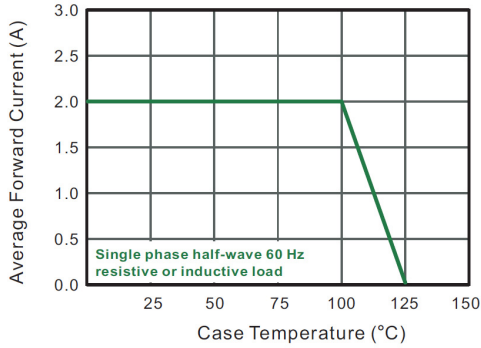

Fig.2 Typical Reverse Characteristics

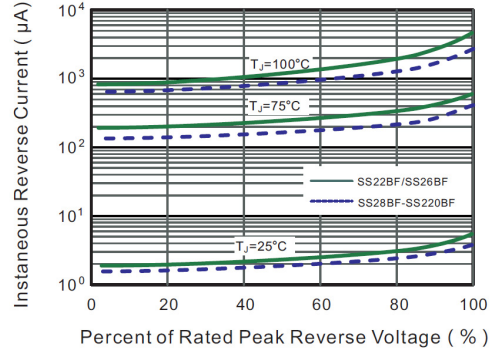

Fig.3 Typical Forward Characteristic

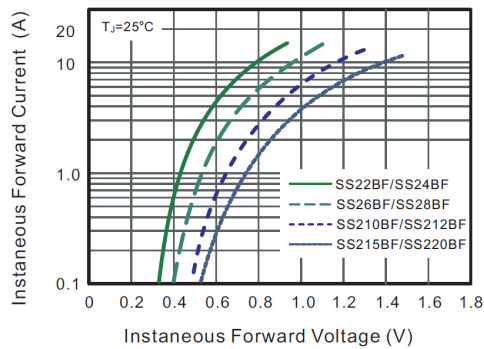

Fig.4 Typical Junction Capacitance

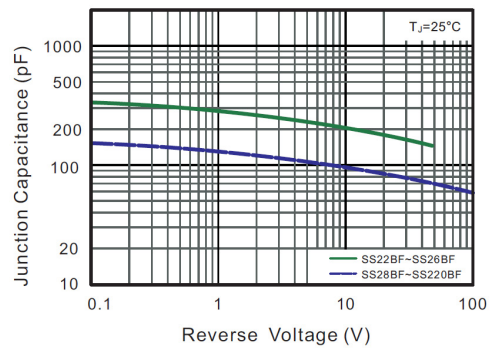

Fig.5 Maximum Non-Repetitive Peak Forward Surge Current

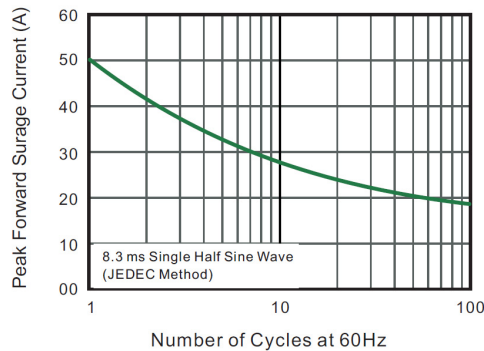
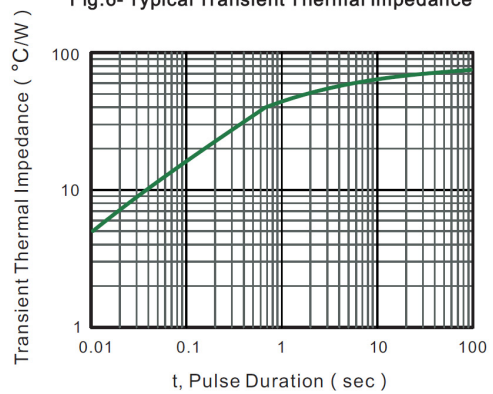
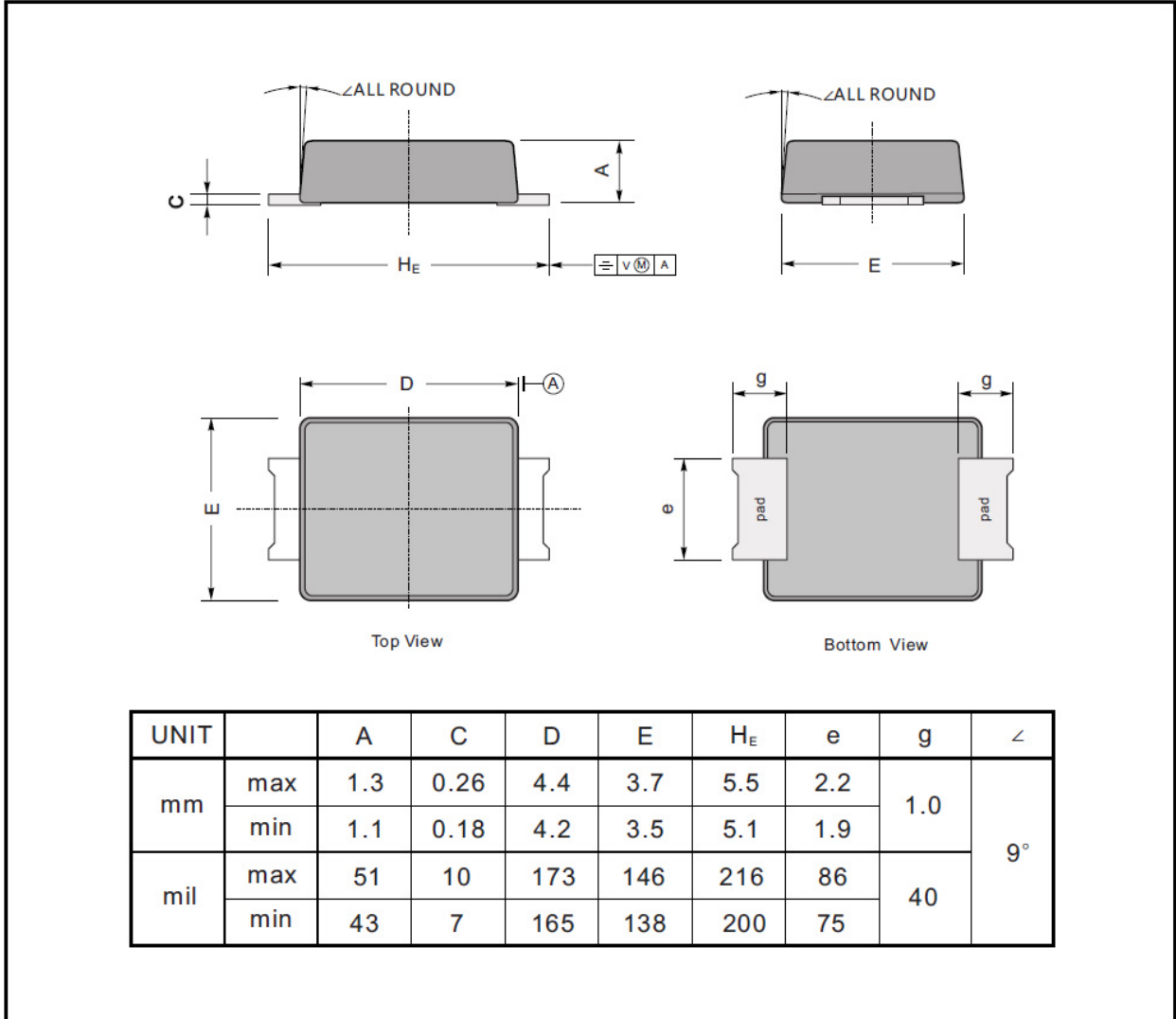

Fig.6- Typical Transient Thermal Impedance



外形尺寸图 / Package Dimensions

SMBF



Marking

Type number	Marking code
SS22BF	S22B
SS24BF	S24B
SS26BF	S26B
SS28BF	S28B
SS210BF	S210B
SS212BF	S212B
SS215BF	S215B
SS220BF	S220B

印章说明 / Marking Instructions

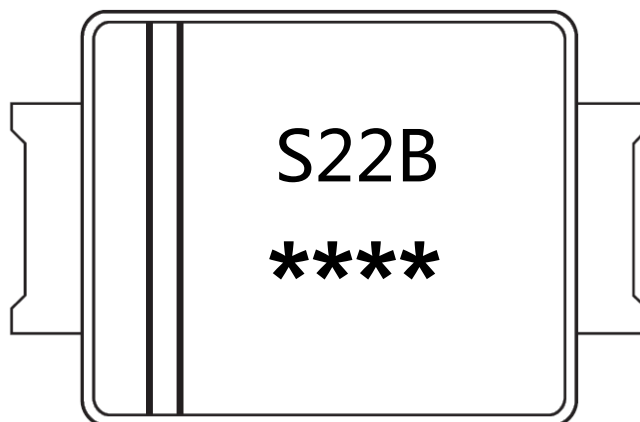

说明：

S22B： 为型号代码

****： 为生产批号追溯码，第1个*为年月代码，后面3个*为当月小批号代码

Note:

S22B： Product Type Code

****： Lot No. Code ,The 1st * means:YM Code ,The last 3 * means:little Lot No Code

回流焊温度曲线图(无铅) / Temperature Profile for IR Reflow Soldering(Pb-Free)

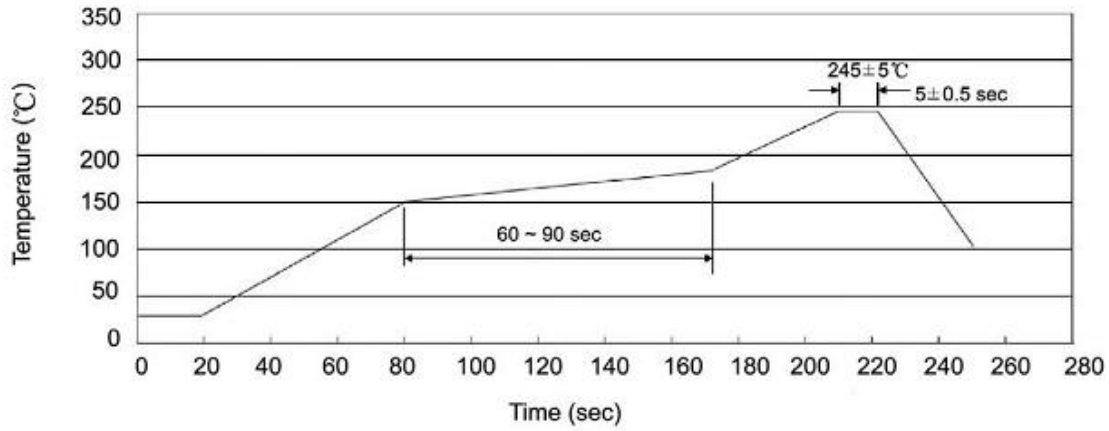

说明：

- 1、预热温度 150 ~ 180°C，时间 60 ~ 90sec;
- 2、峰值温度 245±5°C，时间持续为 5±0.5sec;
- 3、焊接制程冷却速度为 2 ~ 10°C/sec.

Note:

- 1.Preheating:150~180°C, Time:60~90sec.
- 2.Peak Temp.:245±5°C, Duration:5±0.5sec.
3. Cooling Speed: 2~10°C/sec.

耐焊接热试验条件 / Resistance to Soldering Heat Test Conditions

温度：260±5°C

时间：10±1 sec.

Temp.:260±5°C

Time:10±1 sec

包装规格 / Packaging SPEC.

卷盘包装 / REEL

Package Type 封装形式	Units 包装数量					Dimension 包装尺寸 (unit: mm ³)		
	Units/Reel 只/卷盘	Reels/Inner Box 卷盘/盒	Units/Inner Box 只/盒	Inner Boxes/Outer Box 盒/箱	Units/Outer Box 只/箱	Reel	Inner Box 盒	Outer Box 箱
SMBF	5000	2	10000	5	50000	13" ×15	336X332X40	380X335X366

使用说明 / Notices