

MSKSEMI

SEMICONDUCTOR

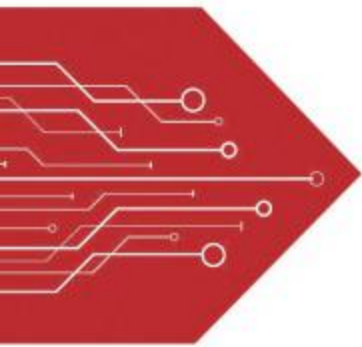

ESD



TVS



TSS



MOV



GDT



PLED

Product data sheet

Description

The MSK3419DF uses advanced trench technology and design to provide excellent $R_{DS(ON)}$ with low gate charge .This device is well suited for high current load applications.

General Features

$V_{DS} = -30V, I_D = -30A$

$R_{DS(ON)} < 12m\Omega @ V_{GS} = -10V$

$R_{DS(ON)} < 18m\Omega @ V_{GS} = -4.5V$

Application

High side switch for full bridge converter
DC/DC converter for LCD display

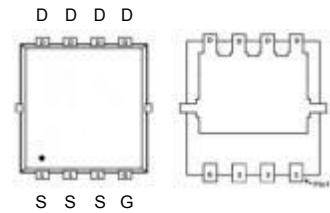

DFN3X3-8L

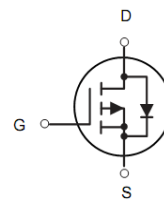

P-Channel MOSFET

Absolute Maximum Ratings@ $T_j=25^{\circ}C$ (unless otherwise specified)

Symbol	Parameter	Rating	Units
VDS	Drain-Source Voltage	-30	V
VGS	Gate-Source Voltage	± 25	V
$I_D @ T_A = 25^{\circ}C$	Drain Current ³ , $V_{GS} @ 10V$	-30	A
$I_D @ T_A = 70^{\circ}C$	Drain Current ³ , $V_{GS} @ 10V$	-9.8	A
IDM	Pulsed Drain Current ¹	-65	A
$P_D @ T_A = 25^{\circ}C$	Total Power Dissipation	3.57	W
TSTG	Storage Temperature Range	-55 to 150	$^{\circ}C$
T_J	Operating Junction Temperature Range	-55 to 150	$^{\circ}C$
R_{thj-c}	Maximum Thermal Resistance, Junction-case	6	$^{\circ}C/W$
R_{thj-a}	Maximum Thermal Resistance, Junction-ambient ³	35	$^{\circ}C/W$

Electrical Characteristics@T_j=25°C(unless otherwise specified)

Symbol	Parameter	Test Conditions	Min.	Typ.	Max.	Units
BV _{DSS}	Drain-Source Breakdown Voltage	V _{GS} =0V, I _D =-250uA	-30	-	-	V
RDS(ON)	Static Drain-Source On-Resistance ²	V _{GS} =-10V, I _D =-15A	-	10	12	mΩ
		V _{GS} =-4.5V, I _D =-10A	-	14	18	mΩ
VGS(th)	Gate Threshold Voltage	V _{DS} =V _{GS} , I _D =-250uA	-1	1.95	-2.5	V
g _{fs}	Forward Transconductance	V _{DS} =-10V, I _D =-6A	-	19	-	S
IDSS	Drain-Source Leakage Current	V _{DS} =-24V, V _{GS} =0V	-	-	-30	uA
IGSS	Gate-Source Leakage	V _{GS} =±20V, V _{DS} =0V	-	-	±100	nA
Q _g	Total Gate Charge	I _D =-15A	-	12.5	24	nC
Q _{gs}	Gate-Source Charge	V _{DS} =-15V	-	5.4	-	nC
Q _{gd}	Gate-Drain ("Miller") Charge	V _{GS} =-4.5V	-	5	-	nC
td(on)	Turn-on Delay Time	V _{DS} =-15V	-	4.4	-	ns
t _r	Rise Time	I _D =-15A	-	11.2	-	ns
td(off)	Turn-off Delay Time	R _G =3.3Ω	-	34	-	ns
t _f	Fall Time	V _{GS} =-10V	-	18	-	ns
C _{iss}	Input Capacitance	V _{GS} =0V	-	1345	2000	pF
C _{oss}	Output Capacitance	V _{DS} =-15V f=1.0MHz	-	194	-	pF
C _{rss}	Reverse Transfer Capacitance		-	158	-	pF
t _{rr}	Reverse Recovery Time	I _S =-15A, V _{GS} =0V, dI/dt=100A/μs	-	12.4	-	ns
Q _{rr}	Reverse Recovery Charge		-	5	-	nC

Notes:

- 1.Pulse width limited by Max. junction temperature.
- 2.Pulse test

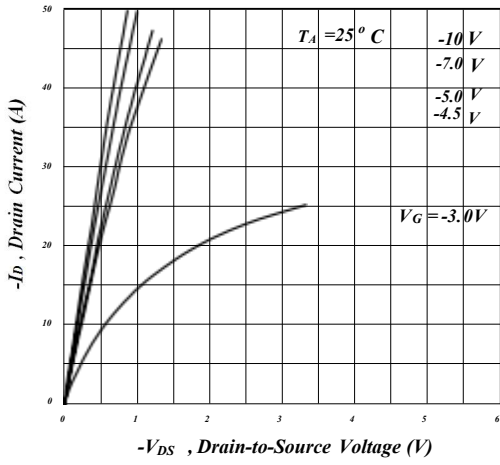

Fig 1. Typical Output Characteristics

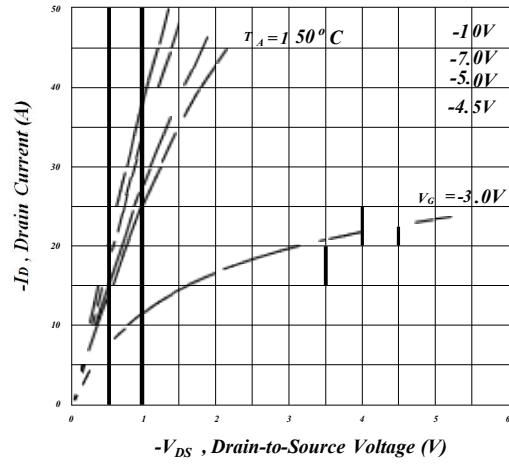

Fig 2. Typical Output Characteristics

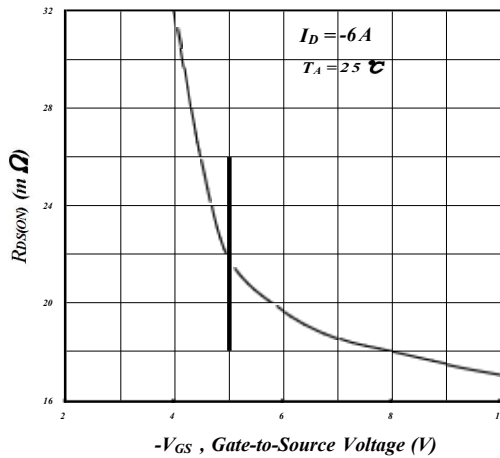

Fig 3. On-Resistance v.s. Gate Voltage

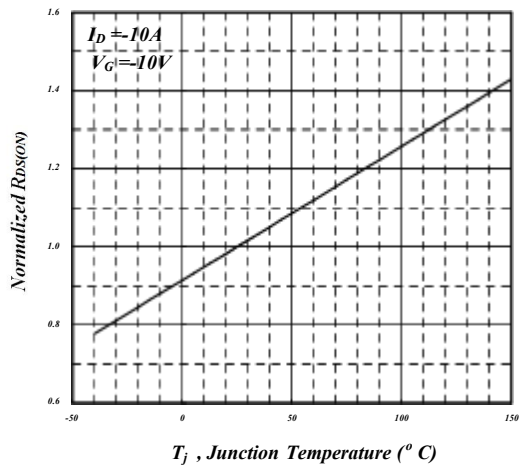

Fig 4. Normalized On-Resistance v.s. Junction Temperature

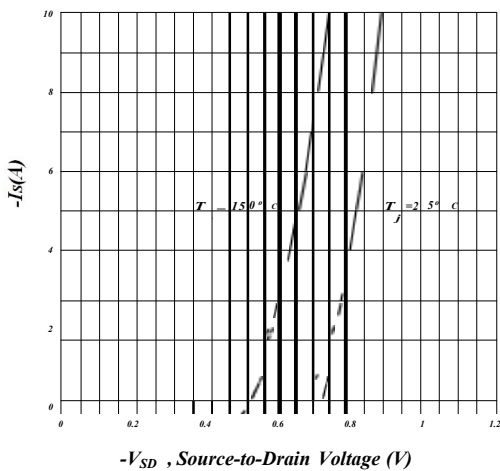

Fig 5. Forward Characteristic of Reverse Diode

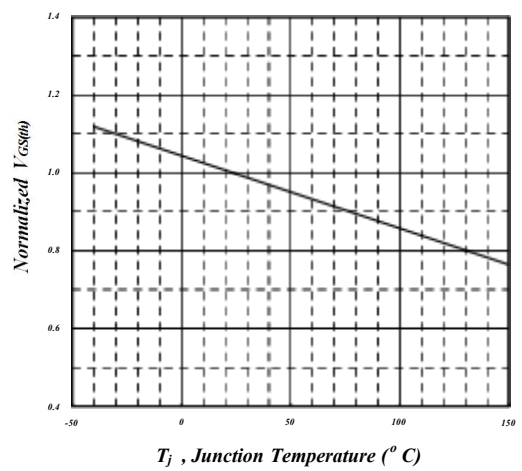

Fig 6. Gate Threshold Voltage v.s. Junction Temperature

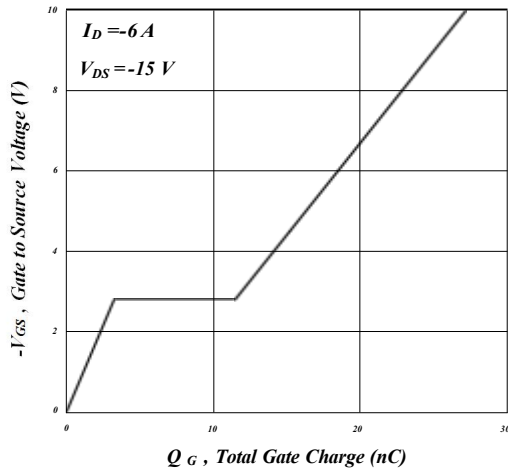

Fig 7. Gate Charge Characteristics

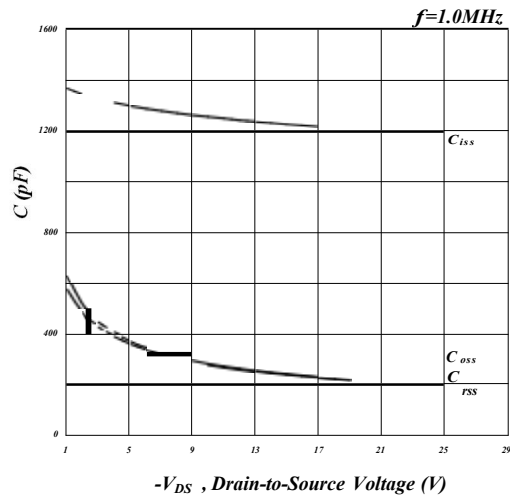

Fig 8. Typical Capacitance Characteristics

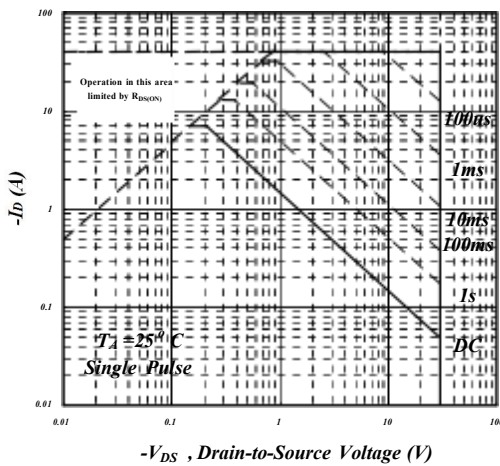

Fig 9. Maximum Safe Operating Area

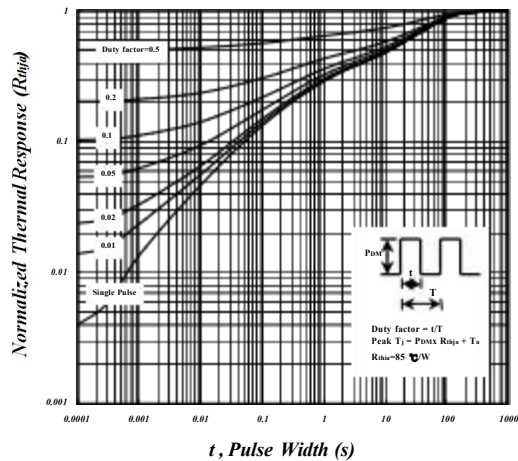

Fig 10. Effective Transient Thermal Impedance

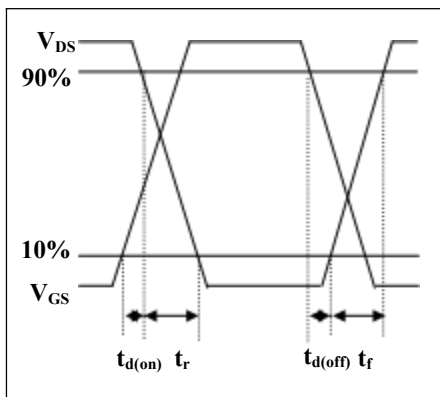

Fig 11. Switching Time Waveform

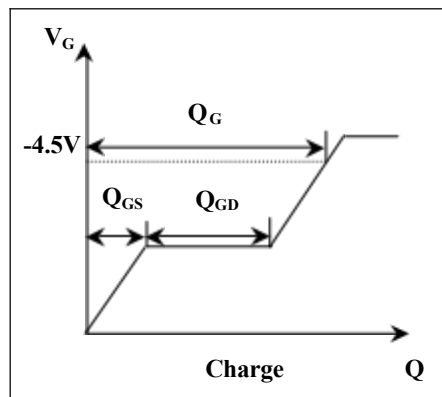
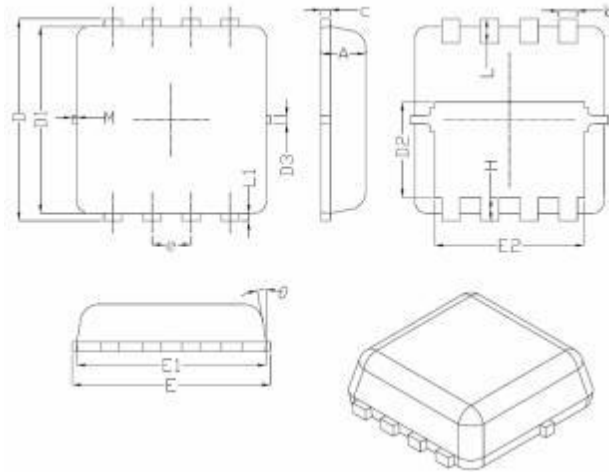

Fig 12. Gate Charge Waveform

DFN3X3-8L Package Information

Symbol	Dimensions In Millimeters		
	Min.	Nom.	Max.
A	0.70	0.75	0.80
b	0.25	0.30	0.35
c	0.10	0.15	0.25
D	3.25	3.35	3.45
D1	3.00	3.10	3.20
D2	1.48	1.58	1.68
D3	-	0.13	-
E	3.20	3.30	3.40
E1	3.00	3.15	3.20
E2	2.39	2.49	2.59
e	0.65BSC		
H	0.30	0.39	0.50
L	0.30	0.40	0.50
L1	-	0.13	-
M	*	*	0.15
θ		10°	12°

REEL SPECIFICATION

P/N	PKG	QTY
MSK3419DF	DFN3X3-8L	5000

Attention

- Any and all MSKSEMI Semiconductor products described or contained herein do not have specifications that can handle applications that require extremely high levels of reliability, such as life-support systems, aircraft's control systems, or other applications whose failure can be reasonably expected to result in serious physical and/or material damage. Consult with your MSKSEMI Semiconductor representative nearest you before using any MSKSEMI Semiconductor products described or contained herein in such applications.
- MSKSEMI Semiconductor assumes no responsibility for equipment failures that result from using products at values that exceed, even momentarily, rated values (such as maximum ratings, operating condition ranges, or other parameters) listed in products specifications of any and all MSKSEMI Semiconductor products described or contained herein.
- Specifications of any and all MSKSEMI Semiconductor products described or contained herein stipulate the performance, characteristics, and functions of the described products in the independent state, and are not guarantees of the performance, characteristics, and functions of the described products as mounted in the customer's products or equipment. To verify symptoms and states that cannot be evaluated in an independent device, the customer should always evaluate and test devices mounted in the customer's products or equipment.
- MSKSEMI Semiconductor strives to supply high-quality high-reliability products. However, any and all semiconductor products fail with some probability. It is possible that these probabilistic failures could give rise to accidents or events that could endanger human lives, that could give rise to smoke or fire, or that could cause damage to other property. When designing equipment, adopt safety measures so that these kinds of accidents or events cannot occur. Such measures include but are not limited to protective circuits and error prevention circuits for safe design, redundant design, and structural design.
- In the event that any or all MSKSEMI Semiconductor products (including technical data, services) described or contained herein are controlled under any of applicable local export control laws and regulations, such products must not be exported without obtaining the export license from the authorities concerned in accordance with the above law.
- No part of this publication may be reproduced or transmitted in any form or by any means, electronic or mechanical, including photocopying and recording, or any information storage or retrieval system, or otherwise, without the prior written permission of MSKSEMI Semiconductor.
- Information (including circuit diagrams and circuit parameters) herein is for example only ; it is not guaranteed for volume production. MSKSEMI Semiconductor believes information herein is accurate and reliable, but no guarantees are made or implied regarding its use or any infringements of intellectual property rights or other rights of third parties.
- Any and all information described or contained herein are subject to change without notice due to product/technology improvement, etc. When designing equipment, refer to the "Delivery Specification" for the MSKSEMI Semiconductor product that you intend to use.