



Document Record						
No.	Date	Modified Content	Page	Edition	Prepared/modified by	Checked by
1	2014.02.14	Draft	6	D	Runsong Zhong	Lianghua Guo
2	2014.04.08	Added TUV certification	6	B/0	Kings Luo	Wenhua Yan
3	2015.02.04	Add 125mA and 250mA CQC certification; Add 200mA I-T Curve	4,15,16	B/1	Kings Luo	Wenhua Yan
4	2015.02.09	Add 8A and 10A CQC certification;	19,20	B/2	Kings Luo	Wenhua Yan
5	2015.06.18	The fuse high to change the 7.6mm	5	B/3	Jeffery	Gem Guo
6	2015.08.04	Update UR certification		B/4	Jeffery	Gem Guo
7	2015.09.09	Update CQC , TUV certification		B/5	Jeffery	Gem Guo
8	2015.11.18	Update the tapping	9	B/6	Jeffery	Lin Gao
9	2015.12.12	Update PSE certification		B/7	Jeffery	Lin Gao
10	2016.01.14	Update I2T value		B/8	Jeffery	Wenhua Yan
11	2016.04.15	Add the 0.16A~0.4A CQC certification	3,7	B/9	Jeffery	Helge
12	2016.8.24	Change the construction		B/10	Jeffery	Wenqiang Luo
13	2017.12.08	Update BSI, SEMKO certification		C/0	J.Q.	Fei Gao
14	2018.03.05	Update TUV certification		C/1	J.Q.	Fei Gao
15	2018.10.08	Change of the innor core and material	4	C/2	Xiang Xiong	Fei Gao
16	2019.02.25	Update UL certification	7	C/3	Xiang Xiong	Fei Gao
17	2019.03.11	Add 6.3A PSE certification	7	C/4	Xiang Xiong	Fei Gao
18	2019.04.24	Add 12A,12.5A,15A and16A IT curve	6	C/5	Xiang Xiong	Fei Gao
19	2019.10.14	Change CQC to CCC		D/0	YaLan Wang	Fei Gao
20	2020.04.23	Update tape drawing		D/1	YaLan Wang	Fei Gao
21	2020.04.24	Add 300V CQC certification		D/2	YaLan Wang	Fei Gao

TABLE OF CONTENTS

1. SCOPE AND DESCRIPTION.....	3
2. GENERAL INFORMATION.....	3
3. AGENCY APPROVALS.....	3
4. PART NUMBERING SYSTEM.....	4
5. CONSTRUCTION AND MECHANICAL CHARACTERISTICS.....	5
6. ELECTRICAL SPECIFICATIONS.....	6
7. SOLDERING PARAMETERS.....	8
8. ORDERING INFORMATION.....	8
9. PACKING INFORMATION.....	9
10.APPENDIX.....	10



1. SCOPE AND DESCRIPTION

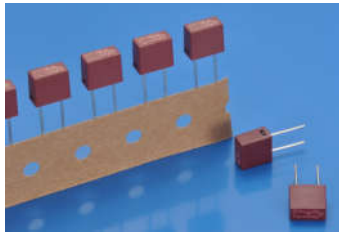

Following electronic product specifications apply to fuses of the 932 series. The 932 series is a sub miniature fuse links for over-current protection.

Its main applications are for consumer electronics, LED drivers, power supplies, battery chargers and controllers for industrial use.

2. GENERAL INFORMATION







General Description

The 932 series provides protection for printed circuit boards used in a large variety of applications that need fuses with time-delay, low breaking capacity. The sub-miniature device is constructed of a plastic cap and base with a tin plated copper lead wire. It offers excellent mounting characteristics and is 100% tested for cold resistance.



Detailed Features

- Subminiature fuse with time delay, low breaking capacity
- Small, rectangular and leaded design minimizes board space and eliminates the need for additional mounting components
- Plastic cap / brown thermoplastic fuse body.
- 0.6mm lead wires made of tin plated copper.
- Protection against harmful over-currents in primary and secondary applications.
- Lead-free, Halogen-free, RoHS compliant
- Designed according to IEC 60127-3
- TUV compliance to EN 60127-7: 2016

3. AGENCY APPROVALS

Agency	Agency File Number	Voltage/ Current Rating
	E300003	400/300/277/250/125V AC: 0.1A~16A;
	2019010207235037	250V AC:125mA;160mA;200mA;250mA;315mA 400mA;500mA;630mA;800mA;1A;1.25A 1.6A;2A;2.5A;3.15A;4A;5A;6.3A;8A;10A
	PSE15020937 PSE19021462	250V AC: 1A, 1.25A, 1.6A, 2A, 2.5A, 3.15A, 4A, 5A, 250V AC: 6.3A
	40033369	250V AC: 630mA, 800mA, 1A, 1.25A, 1.6A, 2A, 2.5A, 3.15A, 4A, 5A, 6.3A
	SU05042-13003, SU05042-13002, SU05042-13001	250V AC: 500mA, 630mA, 800mA, 1A, 1.25A, 1.6A, 2A, 2.5A, 3.15A, 4A, 5A, 6.3A
	CQC20012242947	300V AC:500mA;1A;1.25A;1.6A;2A;2.5A;3.15A;4A;5A; 6.3A;8A;10A



	R 50279350	300V AC: 125mA, 160mA,200mA, 250mA, 315mA, 400mA, 500mA, 630mA, 800mA, 1A, 1.25A, 1.6A, 2A, 2.5A, 3.15A, 4A, 5A, 6.3A, 8A, 10A 250V AC: 125mA, 160mA,200mA, 250mA, 315mA, 400mA, 500mA,
	KM 677189	250V AC:3.15A;5A;8A;10A
 Intertek	1719061	250V AC:3.15A;5A;8A;10A

4. PART NUMBERING SYSTEM

4.1 Part Number

Example: 9321315278

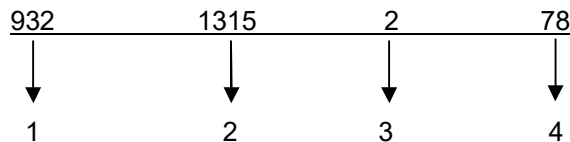

- | | |
|-----------------------------|--|
| 1 .Product Series | 932 |
| 2 .Ampere Rating | 3.15A (see table 4.2 below) |
| 3 .Rated Voltage | 1– 125V
2– 250V
3– 300V
K– 400V |
| 4 .Supplementary Code | Complement Code |

4.2. Ampere / Voltage Rating Table

AMP CODE	CURRENT RATING	VOLTAGE RATING
0100	100mA	125 / 250 / 277/ 300/ 400V AC
0125	125mA	125 / 250 / 277/ 300/ 400V AC
0160	160mA	125 / 250 / 277/ 300/ 400V AC
0200	200mA	125 / 250 / 277/ 300/ 400V AC
0250	250mA	125 / 250 / 277/ 300/ 400V AC
0315	315mA	125 / 250 / 277/ 300/ 400V AC
0400	400mA	125 / 250 / 277/ 300/ 400V AC
0500	500mA	125 / 250 / 277/ 300/ 400V AC
0630	630mA	125 / 250 / 277/ 300/ 400V AC
0800	800mA	125 / 250 / 277/ 300/ 400V AC
1100	1.00A	125 / 250 / 277/ 300/ 400V AC
1125	1.25A	125 / 250 / 277/ 300/ 400V AC
1160	1.60A	125 / 250 / 277/ 300/ 400V AC
1200	2.00A	125 / 250 / 277/ 300/ 400V AC
1250	2.50A	125 / 250 / 277/ 300/ 400V AC
1315	3.15A	125 / 250 / 277/ 300/ 400V AC
1400	4.00A	125 / 250 / 277/ 300/ 400V AC
1500	5.00A	125 / 250 / 277/ 300/ 400V AC
1630	6.30A	125 / 250 / 277/ 300/ 400V AC
1700	7.00A	125 / 250 / 277/ 300/ 400V AC
1800	8.00A	125 / 250 / 277/ 300/ 400V AC



2100	10.00A	125 / 250 / 277/ 300/ 400V AC
2120	12.00A	125 / 250 / 277/ 300/ 400V AC
2125	12.50A	125 / 250 / 277/ 300/ 400V AC
2150	15.00A	125 / 250 / 277/ 300/ 400V AC
2160	16.00A	125 / 250 / 277/ 300/ 400V AC

5. CONSTRUCTION AND MECHANICAL CHARACTERISTICS

Construction (cross section)

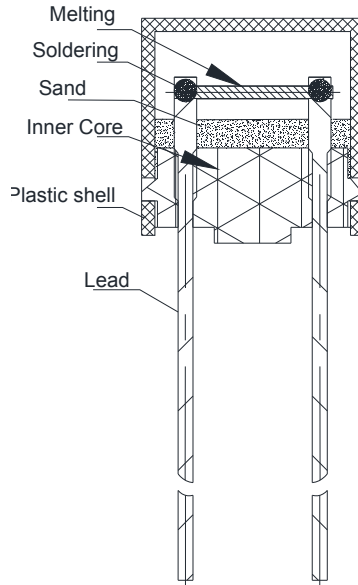

Dimensions (units: mm)

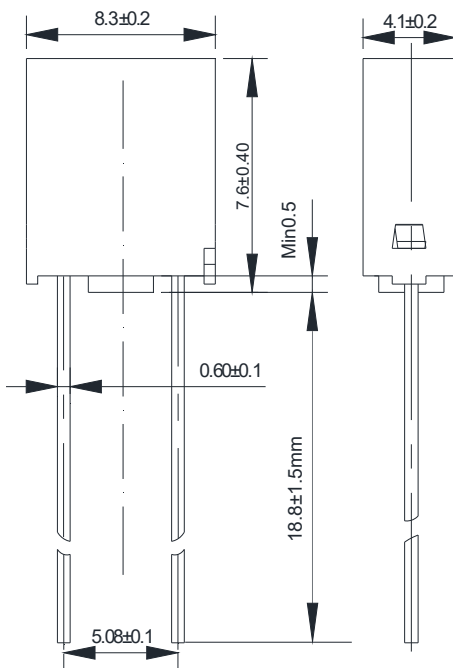

Operating Temperature:
-55°C to +125°C

Storage Conditions:
+10°C to +60°C
Relative humidity: ≤ 75% yearly average without dew, maximum 30 days at 95%

Vibration Resistance:
24 cycles at 15 min. each (60068-6)
10-60Hz at 0.75mm amplitude
60-2000Hz at 10g acceleration

Long Leads: L=18.8±1.5mm

Short Leads: L=4.3±0.3mm



6. ELECTRICAL SPECIFICATIONS

Time vs Current Characteristics Table

(measured with constant current power supply)

Time vs Current Characteristics: IEC 60127-3/IV					
Rated Current	150%	210%	275%	400%	1000%
100mA~6.3A	>1h	<2min	400ms-10s	150ms-3s	20ms-150ms
8A~10A	>1h	<300s	1s~20s	150ms~3s	20ms~150ms
12A~16A	>1h	<300s	1s~50s	150ms~5s	20ms~150ms

Average Time Current (I-T Curves)

Average Current Curve(I-T Curve)

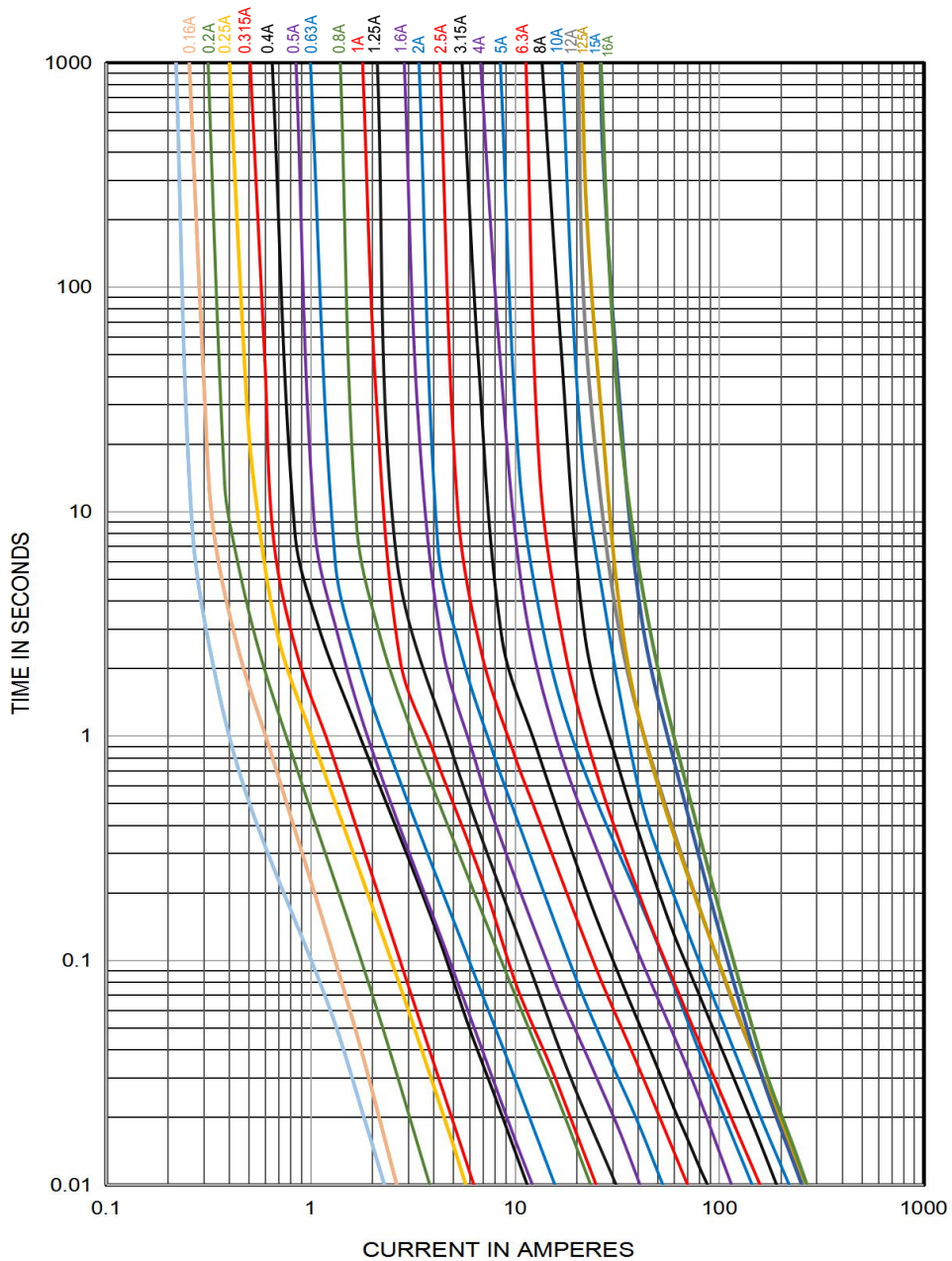



Electrical Characteristics at 25°C

Amp Code	Rated Current	Max. Voltage	Voltage Drop Max(mV)	Max Power Dissipation (mW)	Cold Resistance (mΩ±30%)	Nominal Melting I ² T (A ² sec)	Breaking Capacity	Approvals												
								cURus	VDE	CCC	CQC 300V	PSE	KC	TUV 250V	TUV 300V	BSI	SEMKO			
0100	100mA	400V AC	350	170	/	0.034	100A@125V AC 100A@250V AC 50A or 10In 300V AC 160A@125V/250V AC 100A@277V/300V/400V AC	•	○	○	○	○	○	○	○	○	○	○	○	
0125	125mA		300	180	1500	0.053		•	○	•	○	○	○	•	•	○	○	○	○	○
0160	160mA		280	190	1290	0.073		•	○	•	○	○	○	•	•	○	○	○	○	○
0200	200mA		260	200	796	0.141		•	○	•	○	○	○	•	•	○	○	○	○	○
0250	250mA		240	220	540	0.331		•	○	•	○	○	○	•	•	○	○	○	○	○
0315	315mA		220	250	380	0.348		•	○	•	○	○	○	•	•	○	○	○	○	○
0400	400mA		200	280	219	1.32		•	○	•	○	○	○	•	•	○	○	○	○	○
0500	500mA		190	310	185	1.49		•	○	•	•	○	•	•	•	○	○	○	○	○
0630	630mA		180	360	136	2.46		•	•	•	○	○	•	○	•	○	○	○	○	○
0800	800mA		160	430	120	5.52		•	•	•	○	○	•	○	•	○	○	○	○	○
1100	1.00A		140	500	95	6.70		•	•	•	•	•	•	○	•	○	○	○	○	○
1125	1.25A		130	600	69.8	13.0		•	•	•	•	•	•	○	•	○	○	○	○	○
1160	1.60A		120	730	46.5	22.0		•	•	•	•	•	•	○	•	○	○	○	○	○
1200	2.00A		100	870	34.8	38.0		•	•	•	•	•	•	○	•	○	○	○	○	○
1250	2.50A		100	1000	26.3	56		•	•	•	•	•	•	○	•	○	○	○	○	○
1315	3.15A		100	1200	22	101		•	•	•	•	•	•	○	•	•	•	•	•	•
1400	4.00A		100	1400	14.6	156		•	•	•	•	•	•	○	•	○	○	○	○	○
1500	5.00A		100	1400	11.5	200		•	•	•	•	•	•	○	•	•	•	•	•	•
1630	6.30A		100	1400	8.8	260		•	•	•	•	•	•	○	•	○	○	○	○	○
1800	8.00A		100	1400	6.0	380		•	○	•	•	○	○	○	•	•	•	•	•	•
2100	10.00A		100	1400	4.6	480		•	○	•	•	○	○	○	•	•	•	•	•	•
2120	12.00A	180	4000	3.5	645.8	•	○	○	○	○	○	○	○	○	○	○	○	○		
2125	12.50A	180	4000	3.6	705.6	•	○	○	○	○	○	○	○	○	○	○	○	○		
2150	15.00A	140	4000	2.7	635.2	•	○	○	○	○	○	○	○	○	○	○	○	○		
2160	16.00A	140	4000	2.6	705.6	•	○	○	○	○	○	○	○	○	○	○	○	○		

- Notes:** 1. Permissible continuous operating current is ≤100% at ambient temperature of 23°C (73.4°F)
 2. For certification, the cURus by 125/250/277V/300V/400V, the TUV by 250/300V, the others by 250V.
 3. The current values used for calculating I²T should be within the standard range of 8ms ~ 10ms.

Temperature Derating Curve

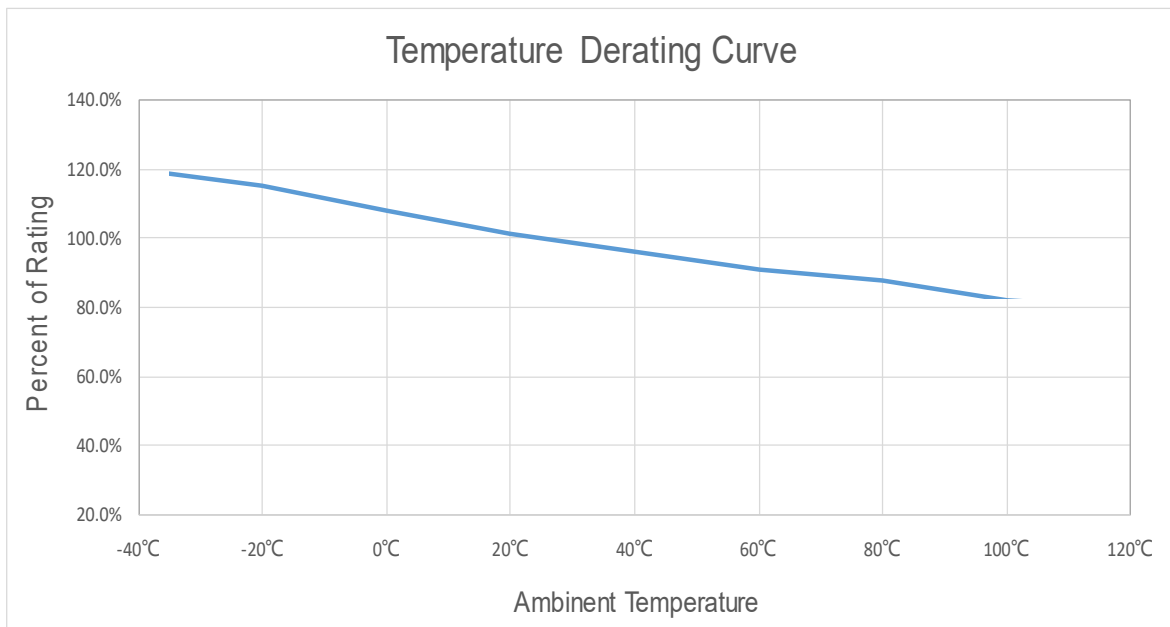

$$\text{Calculation for ideal fuse selection} = \frac{\text{Operating Current (A)}}{\text{Rating (\%} \times 0.75)}$$



7.SOLDERING PARAMETERS

260±5°C.≤5 sec (Wave Soldering)

350°C.≤3 sec (Hand Soldering)

Soldering Peak:

260±5°C - 10 sec (IEC 60068-20)

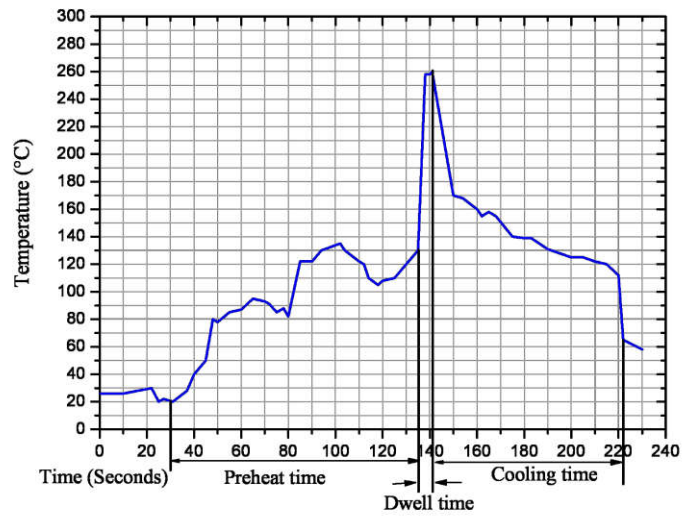

8.ORDERING INFORMATION

The following information are necessary in order to place your order with us correctly:

Series	Amp Code	Supplementary Code	Qty
932			



8.PACKING INFORMATION

Taping detail Unit:mm

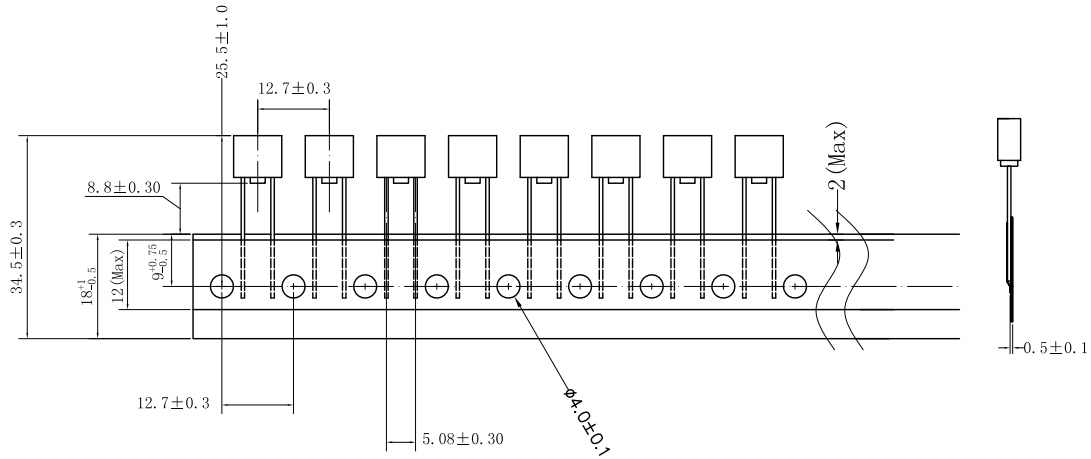

Inner Packaging Box

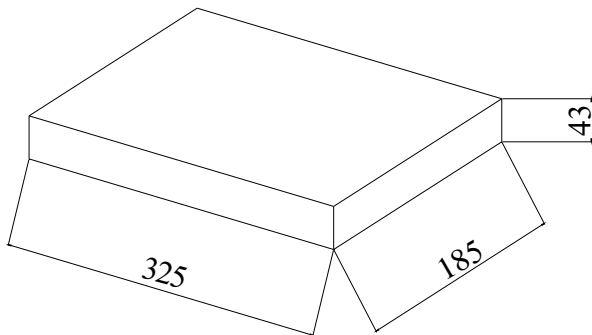

Master Carton

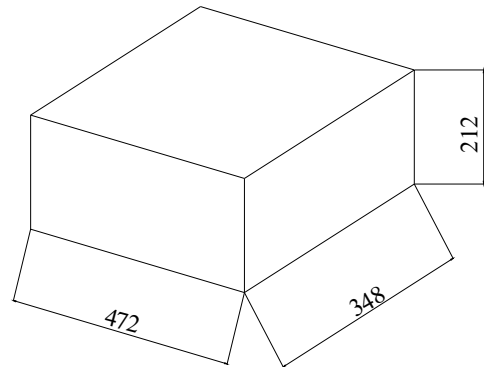

Net Weight (1000pcs+Taping)	0.54Kg	Master Carton Weight	6.10Kg
Qty Per Box	1000pcs	Qty Per Carton	10000pcs

© Dongguan Better Electronics Technology Co.,Ltd.

东莞市贝特电子科技股份有限公司

Room 601 of 16 Block, Xinzhu Yuan, No.4, Xinzhu Road, Songshanlake Hightech Industrial Development Zone, Dongguan City, Guangdong P.R.C

中国广东省东莞市松山湖国家高新技术产业开发区新竹路4号新竹苑16座办公601

Tel: +86 769-2307 8212 Fax: +86 769-8352 1857

Web: www.betterfuse.com

Email: info@betterfuse.com



9. APPENDIX



Verify your Plastic's Yellow Card!

UL's New Recognized Plastics Material Identification Service identifies material composition and helps confirm that the intended Recognized Plastics are the actual plastics received and used.

[Learn More >](#)



Advertisement

Dashboard / Search / FUSES, SUPPLEMENTAL - COMPONENT | UL Product iQ

JDYX2.E300003 - FUSES, SUPPLEMENTAL - COMPONENT

DETAILS

File No.: E300003

CCN: [JDYX2](#)

Document Type: Listing

Parent CCN: [JCQR2](#)

RESOURCES

[UL Confirmation Letter](#)

[Guide Info \(JDYX2\)](#)

[Document](#) [Company Information](#) [Related Information](#)



Fuses, Supplemental - Component

[See General Information for Fuses, Supplemental - Component](#)

DONGGUAN BETTER ELECTRONICS TECHNOLOGY CO LTD

Rm 601 Of 16 Bldg
Xinzhuoyuan No 4 Xinzhu Rd
Songshanlake Hightech Industrial Development Zone
Dongguan, Guangdong 523808 CHINA

E300003

Supplemental fuses

Supplemental micro fuses: pigtail leads

Cat. No.	Size mm(in)	Amps (A)	Volts (V)	Interrupting Rating (A)
932	8.5 x 4 x 8 (0.33 x 0.16 x 0.31)	0.1 - 0.4	400Vac	100
		0.1 - 0.4	300Vac	100
		0.1 - 0.4	277Vac	100
		0.1 - 0.4	250Vac	100
		0.1 - 0.4	125Vac	100
		0.1 - 0.4	300Vac	50
		0.1 - 0.4	250Vac	160
		0.1 - 0.4	125Vac	160
		0.5 - 6.3	400Vac	100
		0.5 - 6.3	300Vac	100
		0.5 - 6.3	277Vac	100
		0.5 - 6.3	250Vac	100
		0.5 - 6.3	125Vac	100
		0.5 - 6.3	300Vac	50
		0.5 - 6.3	250Vac	160
		0.5 - 6.3	125Vac	160
		7 - 12	400Vac	100
		7 - 12	300Vac	100
		7 - 12	277Vac	100
		7 - 12	250Vac	100
7 - 12	125Vac	100		
7 - 12	300Vac	50		
7 - 12	250Vac	160		
7 - 12	125Vac	160		
12.5 - 16	400Vac	100		
12.5 - 16	300Vac	100		
12.5 - 16	277Vac	100		
12.5 - 16	250Vac	100		
12.5 - 16	125Vac	100		
12.5 - 16	300Vac	50		
12.5 - 16	250Vac	160		
12.5 - 16	125Vac	160		



中国国家强制性产品认证证书

证书编号：2019010207235037

委托人名称、地址

东莞市贝特电子科技股份有限公司
东莞市松山湖高新技术产业开发区新竹路4号新竹苑16座办公601

生产者（制造商）名称、地址

东莞市贝特电子科技股份有限公司
东莞市松山湖高新技术产业开发区新竹路4号新竹苑16座办公601

生产企业名称、地址

东莞市贝特电子科技股份有限公司
东莞市寮步镇横坑南门村第二工业区C座、B座

产品名称和系列、规格、型号

超小型熔断体

932 T125mAL250V、932 T160mAL250V、932 T200mAL250V、932 T250mAL250V、932 T315mAL250V、932 T400mAL250V、932 T500mAL250V、932 T630mAL250V、932 T800mAL250V、932 T1AL250V、932 T1.25AL250V、932 T1.6AL250V、932 T2AL250V、932 T2.5AL250V、932 T3.15AL250V、932 T4AL250V、932 T5AL250V、932 T6.3AL250V、932 T8AL250V、932 T10AL250V

产品标准和技术要求

GB/T9364.3-2018;GB/T9364.1-2015

上述产品符合强制性产品认证实施规则 CNCA-C02-01:2014 的要求，特发此证。

发证日期：2019年10月11日 有效期至：2024年10月11日
证书有效期内本证书的有效性依据发证机构的定期监督获得保持。

本证书的相关信息可通过国家认监委网站 www.cnca.gov.cn 查询



主任：陆梅



中国质量认证中心



CERTIFICATE FOR CHINA COMPULSORY PRODUCT CERTIFICATION

CERTIFICATE NO.: 2019010207235037

NAME AND ADDRESS OF THE APPLICANT

Dongguan Better Electronics Technology Co., Ltd.
Room 601 of 16 Block, Xinzhu Yuan, No 4, Xinzhu Road, Songshanlake Hightech Industrial Development Zone, Dongguan City, Guangdong Province, PRC

NAME AND ADDRESS OF THE MANUFACTURER

Dongguan Better Electronics Technology Co., Ltd.
Room 601 of 16 Block, Xinzhu Yuan, No 4, Xinzhu Road, Songshanlake Hightech Industrial Development Zone, Dongguan City, Guangdong Province, PRC

NAME AND ADDRESS OF THE FACTORY

Dongguan Better Electronics Technology Co., Ltd.
NanMen Village, HengKeng Administrative Zone LiaoBu Town, Dongguan, Guangdong, China.

PRODUCT NAME, MODEL AND SPECIFICATION

Sub-miniature fuse-links

932 T125mAL250V、932 T160mAL250V、932 T200mAL250V、932 T250mAL250V、932 T315mAL250V、932 T400mAL250V、932 T500mAL250V、932 T630mAL250V、932 T800mAL250V、932 T1AL250V、932 T1.25AL250V、932 T1.6AL250V、932 T2AL250V、932 T2.5AL250V、932 T3.15AL250V、932 T4AL250V、932 T5AL250V、932 T6.3AL250V、932 T8AL250V、932 T10AL250V

THE STANDARDS AND TECHNICAL REQUIREMENTS FOR THE PRODUCTS

GB/T9364.3-2018;GB/T9364.1-2015

This is to certify that the above mentioned product(s) complies with the requirements of implementation rules for compulsory certification(REFNO.CNCA-C02-01:2014).

Valid from: Oct.11,2019

Valid until: Oct.11,2024

The validity of the certificate is subject to positive result of the regular follow up inspection by issuing certification body until the expiry date.

The certificate information is available through CNCA's website: www.cnca.gov.cn



President: 
Lu Mei



CHINA QUALITY CERTIFICATION CENTRE



产品认证证书

证书编号：CQC20012242947

申请人名称及地址

东莞市贝特电子科技股份有限公司
东莞市松山湖高新技术产业开发区新竹路4号新竹苑16座办公601

制造商名称及地址

东莞市贝特电子科技股份有限公司
东莞市松山湖高新技术产业开发区新竹路4号新竹苑16座办公601

生产企业名称及地址

东莞市贝特电子科技股份有限公司(V003591)
东莞市寮步镇横坑南门村第二工业区C座、B座

产品名称和系列、规格、型号

特殊应用的小型熔断体

932 500mA a.c. 300V、932 1A a.c. 300V、932 1.25A a.c. 300V、932 1.6A a.c. 300V、932 2A a.c. 300V、932 2.5A a.c. 300V、
932 3.15A a.c. 300V、932 4A a.c. 300V、932 5A a.c. 300V、932 6.3A a.c. 300V、932 8A a.c. 300V、932 10A a.c. 300V
(额定分断能力：100A，主要尺寸：8.5mm×4mm×8.5mm)

产品标准和技术要求

GB/T 9364.1-2015;GB/T 9364.7-2016

认证模式

产品型式试验+初次工厂检查+获证后监督

上述产品符合 CQC11-462125-2018 认证规则的要求，特发此证。

发证日期：2020年04月21日 有效期至：2025年04月21日

证书有效期内本证书的有效性依据发证机构的定期监督获得保持。

主任：

陆梅



中国质量认证中心

中国·北京·南四环西路188号9区100070

<http://www.cqc.com.cn>

C 0238413



PRODUCT CERTIFICATE

CERTIFICATE NO.: CQC20012242947

NAME AND ADDRESS OF THE APPLICANT

Dongguan Better Electronics Technology Co., Ltd.
Room 601 of 16 Block, Xinzhu Yuan, No. 4 Xinzhu Road, Songshanlake Hightech Industrial Development
Zone, Dongguan City

NAME AND ADDRESS OF THE MANUFACTURER

Dongguan Better Electronics Technology Co., Ltd.
Room 601 of 16 Block, Xinzhu Yuan, No. 4 Xinzhu Road, Songshanlake Hightech Industrial Development
Zone, Dongguan City

NAME AND ADDRESS OF THE FACTORY

Dongguan Better Electronics Technology Co., Ltd. (V003591)
NanMen Village, HengKen Administrative Zone LiaoBu Town, Dongguan, Guangdong, China

PRODUCT NAME, MODEL AND SPECIFICATION

Miniature Fuse-links for Special applications
932 500mA a.c. 300V、932 1A a.c. 300V、932 1.25A a.c. 300V、932 1.6A a.c. 300V、932 2A a.c. 300V、932 2.5A a.c. 300V、
932 3.15A a.c. 300V、932 4A a.c. 300V、932 5A a.c. 300V、932 6.3A a.c. 300V、932 8A a.c. 300V、932 10A a.c. 300V (额
定分断能力: 100A, 主要尺寸: 8.5mm×4mm×8.5mm)

THE STANDARDS AND TECHNICAL REQUIREMENTS FOR THE PRODUCTS

GB/T 9364.1-2015;GB/T 9364.7-2016

TYPE OF CERTIFICATION SCHEMES

Type Testing of Product + Initial Factory Inspection + Follow up Factory Inspection

This is to certify that the above mentioned product(s) complies with the requirements of certification
rules of CQC11-462125-2018 .

Valid from: Apr.21,2020

Valid until: Apr.21,2025

The validity of the certificate is subject to positive result of the regular follow up inspection by issuing
certification body until the expiry date.

President:

Lu Mei



CHINA QUALITY CERTIFICATION CENTRE

Section 9, No.188, Nansihuan Xilu, Beijing 100070 P.R.China
<http://www.cqc.com.cn>

C 0238413



適合証明書

Certificate of Conformity

証明書番号 Certificate No.

PSE15020937

申請者照会番号 Applicant Reference

CJP2015102004-1199

発行年月日 Date of Issue

2015年11月12日

申請者 Applicant

DONGGUAN BETTER ELECTRONICS
TECHNOLOGY CO.,LTD

ROOM 601 OF 16 BLOCK, XINZHUYUAN, NO 4,
XINZHU ROAD, SONGSHANLAKE HIGHTECH
INDUSTRIAL DEVELOPMENT ZONE, DONGGUAN
CITY, GUANGDONG PROVINCE, P.R.CHINA 523808

製造工場 Factory

DONGGUAN BETTER ELECTRONICS
TECHNOLOGY CO.,LTD

NANMEN VILLAGE, HENGKENG
ADMINISTRATIVE ZONE LIAOBU TOWN,
DONGGUAN, GUANGDONG, P.R.CHINA 523413



検査の方法 Standard for Certificate

- 電気用品の技術基準の解釈 別表第十二 国際規格等に準拠した基準
J60127-1(H26); J60127-3(H20)

- 施行規則別表第四

Appendix 4 of the Enforcement Regulations

特定電気用品名:

Name of Specified Electrical
Appliance and Material

型式の区分:

Type Classification

モデル名:

Model

製造事業者:

Manufacturer

証明書の有効期間:

Validity of Certificate

その他の包装ヒューズ

Other enclosed fuses

(「添付書類」参照)

(Refer to Attachment)

932 T1AL250V, 932 T1.25AL250V, 932 T1.6AL250V, 932 T2AL250V,
932 T2.5AL250V, 932 T3.15AL250V, 932 T4AL250V, 932 T5AL250V

DONGGUAN BETTER ELECTRONICS TECHNOLOGY CO.,LTD

2022年11月11日までに有効です。

This certificate is expired on Nov. 11th, 2022

これは、上記申請者より申請のあった上記特定電気用品及び製造工場が、電気用品安全法第八条第一項に規定する技術基準及び同法第九条第二項の経済産業省令で定める基準に適合していることを証明するものです。

This is to certify that the above-mentioned Specified Electrical Appliances and Materials and the factory which the above-mentioned applicant applied for have been complied with the Technical Requirements stipulated by Article 8, Paragraph 1 of the Electrical Appliance and Material Safety Law and the requirements stipulated by the METI Ordinance specified in Article 9, paragraph 2 of the said law.

中国品質認証センター
CHINA QUALITY
CERTIFICATION CENTRE

氏名
Name

発行者
Issued by



中国100070北京市南四环西路188号9区

Section 9, No.188, Nansihuan Xilu, Beijing 100070, China

PJ 0004128



適合証明書

Certificate of Conformity

添付書類 Attachment 1

証明書番号(Certificate No.) :
PSE15020937

発行日 Date of Issue :
2015年11月12日

【型式の区分 Type Classification】

特定電気用品 :
(Name of Specified Electrical Appliance and Material)

その他の包装ヒューズ
Other enclosed fuses

要素	区分
定格電圧	(1) 125V以下のもの (2) 125Vを超えるもの
定格電流 (定格電流表示のあるものの場合に限る。)	(1) 5A以下のもの (2) 5Aを超え15A以下のもの (3) 15Aを超え30A以下のもの (4) 30Aを超え60A以下のもの (5) 60Aを超え100A以下のもの (6) 100Aを超えるもの
適用電動機の定格容量 (定格電流表示のないものの場合に限る。)	(1) 単相で200W以下のもの (2) 単相で200Wを超え400W以下のもの (3) 単相で400Wを超え750W以下のもの (4) 単相で750Wを超えるもの (5) 3相で750W以下のもの (6) 3相で750Wを超え2.2kW以下のもの (7) 3相で2.2kWを超え3.7kW以下のもの (8) 3相で3.7kWを超え7.5kW以下のもの (9) 3相で7.5kWを超えるもの
可溶体の主材料	(1) 銀のもの (2) アルミニウムのもの (3) 亜鉛のもの (4) 鉛のもの (5) 銅のもの (6) その他のもの

中国品質認証センター
CHINA QUALITY
CERTIFICATION CENTRE

氏名
Name

発行者
Issued by



中国100070北京市南四環西路188号9区

Section 9, No.188, Nansihuan Xilu, Beijing 100070, China



適合証明書

Certificate of Conformity

添付書類 Attachment 2

証明書番号(Certificate No.):
PSE15020937

発行日 Date of Issue :
2015年11月12日

【 型式の区分 Type Classification 】

特定電気用品 :

(Name of Specified Electrical Appliance and Material)

その他の包装ヒューズ

Other enclosed fuses

可溶体の数	(1) 1のもの (2) 2以上のもの
再使用 (管形ヒューズを除く。)	(1) できるもの (2) できないもの
内部充てん物	(1) あるもの (2) ないもの
筒 (内筒を除く。) の材料	(1) フェノール樹脂のもの (2) ファイバーのもの (3) 磁器のもの又はガラスのもの (4) ポリエステル樹脂のもの (5) メラミン樹脂のもの (6) ユリア樹脂のもの (7) その他のもの
端子	(1) 刃形のもの (2) 筒形のもの (3) 締付け形のもの (4) リード線付きのもの (5) その他のもの
排気孔	(1) あるもの (2) ないもの
溶断の表示	(1) あるもの (2) ないもの
用途	(1) 電動機用のもの (2) 電子機器用のもの (3) 短絡保護専用のもの (4) その他のもの

中国品質認証センター
CHINA QUALITY
CERTIFICATION CENTRE

氏名
Name

発行者
Issued by



中国100070北京市南四環西路188号9区

Section 9, No.188, Nansihuan Xilu, Beijing 100070, China



適合証明書

Certificate of Conformity

添付書類 Attachment 3

証明書番号(Certificate No.) :
PSE15020937

発行日 Date of Issue :
2015年11月12日

【 型式の区分 Type Classification 】

特定電気用品 :
(Name of Specified Electrical Appliance and Material)

その他の包装ヒューズ
Other enclosed fuses

定格遮断電流	<ul style="list-style-type: none"> (1) 100A以下のもの (2) 100Aを超え300A以下のもの (3) 300Aを超え500A以下のもの (4) 500Aを超え1,000A以下のもの (5) 1,000Aを超え1,500A以下のもの (6) 1,500Aを超え2,500A以下のもの (7) 2,500Aを超え5,000A以下のもの (8) 5,000Aを超え7,500A以下のもの (9) 7,500Aを超え10,000A以下のもの (10) 10,000Aを超え15,000A以下のもの (11) 15,000Aを超え20,000A以下のもの (12) 20,000Aを超え25,000A以下のもの (13) 25,000Aを超え30,000A以下のもの (14) 30,000Aを超えるもの
--------	--

中国品質認証センター
CHINA QUALITY
CERTIFICATION CENTRE

氏名
Name

発行者
Issued by



中国100070北京市南四环西路188号9区

Section 9, No.188, Nansihuan Xilu, Beijing 100070, China



適合同等証明書

Statement of Conformity Assessment

証明書番号 Statement No.

PSE19021462

申請者照会番号 Applicant Reference

CJP2018102004-1759

発行年月日 Date of Issue

2019年3月7日

申請者 Applicant

DONGGUAN BETTER ELECTRONICS
TECHNOLOGY CO., LTD
ROOM 601 OF 16 BLOCK, XINZHUYUAN,
NO 4, XINZHU ROAD, SONGSHANLAKE
HIGHTECH INDUSTRIAL DEVELOPMENT
ZONE, DONGGUAN CITY, GUANGDONG
PROVINCE, P. R. CHINA 523808

製造工場 Factory

DONGGUAN BETTER ELECTRONICS
TECHNOLOGY CO., LTD LIAOBU BRANCH
BUILDING B/C, 2ND INDUSTRIAL ZONE,
NANMEN VILLAGE, HENGKENG
ADMINISTRATIVE ZONE LIAOBU TOWN,
DONGGUAN, GUANGDONG, P. R. CHINA 523413.



検査の方法 Technical standards

・電気用品の技術上の基準を定める省令の解釈 別表第十二 国際規格等に準拠した基準

J60127-1(H28) ; J60127-3(H28)

・施行規則別表第四

Appendix 4 of the Enforcement Regulations

特定電気用品名 :

Name of Specified Electrical
Appliance and Material

その他の包装ヒューズ

Other enclosed fuses

型式の区分 :

Type Classification

(「添付書類」参照)

(Refer to Attachment)

モデル名 :

Model

932 T6,3AL250V

証明書の有効期間 :

Validity of Statement

2026年3月6日まで有効です。

This statement will expire on Mar.6th,2026

電気用品安全法第8条第1項に規定する技術基準及び同法第9条第2項の経済産業省令で定める基準(法第9条第1項第2号に係る検査に係るものに限る)に適合していることを証明します

I hereby certify that the product mentioned above complies with the technical requirements stipulated in Paragraph 1 of Article 8 of Electrical Appliances and Materials Safety Act (here under referred to as the Act) and the requirements defined by the ordinance of the Ministry of Economy, Trade and Industry based on Paragraph 2 of Article 9 of the Act (limited to Item 2 of Paragraph 1 of Article 9 for Inspection of the Act).

中国品質認証センター
CHINA QUALITY
CERTIFICATION CENTRE
〒100070

中国100070北京市南四环西路188号9区

Section 9, No.188, Nansihuan Xilu, Beijing 100070 P.R. China

氏名
Name

陸楠

発行者
Issued by



ST 0000698



適合同等証明書

Statement of Conformity Assessment

添付書類 Attachment 1

証明書番号(Statement No.):
PSE19021462

発行日 Date of Issue :
2019年3月7日

【 型式の区分 Type Classification 】

特定電気用品 :
(Name of Specified Electrical Appliance and Material)

その他の包装ヒューズ
Other enclosed fuses

要素	区分
定格電圧	(1) 125V以下のもの (2) 125Vを超えるもの
定格電流 (定格電流表示のあるものの場合に限る。)	(1) 5A以下のもの (2) 5Aを超え15A以下のもの (3) 15Aを超え30A以下のもの (4) 30Aを超え60A以下のもの (5) 60Aを超え100A以下のもの (6) 100Aを超えるもの
適用電動機の定格容量 (定格電流表示のないものの場合に限る。)	(1) 単相で200W以下のもの (2) 単相で200Wを超え400W以下のもの (3) 単相で400Wを超え750W以下のもの (4) 単相で750Wを超えるもの (5) 3相で750W以下のもの (6) 3相で750Wを超え2.2kW以下のもの (7) 3相で2.2kWを超え3.7kW以下のもの (8) 3相で3.7kWを超え7.5kW以下のもの (9) 3相で7.5kWを超えるもの
可溶体の主材料	(1) 銀のもの (2) アルミニウムのもの (3) 亜鉛のもの (4) 鉛のもの (5) 銅のもの (6) その他のもの

中国品質認証センター
CHINA QUALITY
CERTIFICATION CENTRE
〒100070

氏名
Name

陸梅

発行者
Issued by



中国100070北京市南四环西路188号9区
Section 9, No.188, Nansihuan Xilu, Beijing 100070 P.R. China

Zertifikat

Certificate



Zertifikat Nr. *Certificate No.*
R 50279350

Blatt *Page*
0001

<i>Ihr Zeichen Client Reference</i>	<i>Unser Zeichen Our Reference</i>	<i>Ausstellungsdatum Date of Issue</i>	<i>(day/mo/yr)</i>
	05-YFC- 16058722 001	28.03.2014	

Genehmigungsinhaber *License Holder*

Dongguan Better Electronics
Technology Co., Ltd.
Room No. 102, 103 of 3rd block
114 of 4th Block Innovtive Tech.
Park of Songshan Lake High-tech Ind.
Park, Dongguan, Guangdong Guangdong
P.R. China

Fertigungsstätte *Manufacturing Plant*

Dongguan Better Electronics
Technology Co., Ltd.
Nanmen Village, Hengken
Administrative Zone, Liaobu Town
Dongguan, Guangdong
Guangdong
P.R. China

Prüfzeichen *Test Mark*



Type Approved
Safety
Regular Production
Surveillance

www.tuv.com
ID 2000000000

Gepprüft nach *Tested acc. to*
EN 60127-1:2006+A1
EN 60127-7:2013

Zertifiziertes Produkt *(Geräteidentifikation)*
Certified Product (Product Identification)

Lizenzentgelte - Einheit
License Fee - Unit

Fuse Link (Miniature Fuse-link)

Type Designation	: 932	15
Trademark	: Better(Logo)	
Rated Voltage	: AC 300V	
Rated Current	: 500mA; 630mA; 800mA; 1A; 1,25A; 1,6A; 2A; 2,5A; 3,15A; 4A; 5A; 6,3A 8A, 10A	
T/I Characteristic	: t2=2min; t3=400ms; t4=10s; t5=150ms t6=3s; t7=20ms; t8=150ms	
Rated Breaking Capacity:	AC 50A or 10In (which is higher)	

Remark:

- 1)The product also comply with IEC60127-1:2006+A1 and IEC60127-7:2013.
- 2)The labelling requirements acc. to EU Directive 2001/95 have to be observed for distribution within the EEA.

ANLAGE (Appendix): 1

Dem Zertifikat liegt unsere Prüf- und Zertifizierungsordnung zugrunde und es bestätigt die Konformität des Produktes mit den oben genannten Standards und Prüfgrundlagen. Zusätzliche Anforderungen in Ländern, in denen das Produkt in Verkehr gebracht werden soll, müssen zusätzlich betrachtet werden. Die Herstellung des zertifizierten Produktes wird überwacht.
This certificate is based on our Testing and Certification Regulation and states the conformity of the product with the standards and testing requirements as indicated above. Any additional requirements in countries where the product is going to be marketed have to be considered additionally. The manufacturing of the certified product is subject to surveillance.

TÜV Rheinland LGA Products GmbH - Tillystraße 2 - 90431 Nürnberg

Tel.: (+49/221)8 06 - 13 71 e-mail: cert-validity@de.tuv.com
Fax: (+49/221)8 06 - 39 35 http://www.tuv.com/safety



G. Yin

Zertifikat

Certificate

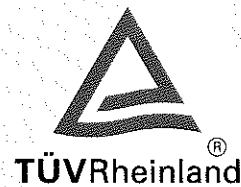

Zertifikat Nr. *Certificate No.*
R 50279350

Blatt *Page*
0002

Ihr Zeichen <i>Client Reference</i>	Unser Zeichen <i>Our Reference</i>	Ausstellungsdatum	<i>Date of Issue</i> (day/mo/yr)
	05-YFC- 16058722 002	20.08.2015	

Genehmigungsinhaber *License Holder*
Dongguan Better Electronics
Technology Co., Ltd.
Room 601 of 16 Block, Xinzhu Yuan
No 4, Xinzhu Road, Songshan Lake
Hightech Ind. Development Zone
Dongguan City, Guangdong Province
P.R. China

Fertigungsstätte *Manufacturing Plant*
Dongguan Better Electronics
Technology Co., Ltd.
Nanmen Village, Hengkeng
Administrative Zone, Liaobu Town
Dongguan, Guangdong
P.R. China

Prüfzeichen *Test Mark*

Geprüft nach *Tested acc. to*
EN 60127-1:2006+A1
EN 60127-7:2013



Zertifiziertes Produkt (Geräteidentifikation)
Certified Product (Product Identification)

Lizenzentgelte - Einheit
License Fee - Unit

Fuse Link (Miniature Fuse-link)

As page 0001

Change

Address of the license holder: see above

Additional

Rated Current : 1) 125mA; 160mA; 200mA;
250mA; 315mA; 400mA
2) 500mA
Rated Voltage : 1) AC 250V/300V; 2) 250V

Remark:

- 1) The product also comply with IEC60127-1:2006+A1 and IEC60127-7:2013.
- 2) The labelling requirements acc. to EU Directive 2001/95 have to be observed for distribution within the EEA.

ANLAGE (Appendix): 1.1

Dem Zertifikat liegt unsere Prüf- und Zertifizierungsordnung zugrunde und es bestätigt die Konformität des Produktes mit den oben genannten Standards und Prüfgrundlagen. Zusätzliche Anforderungen in Ländern, in denen das Produkt in Verkehr gebracht werden soll, müssen zusätzlich betrachtet werden. Die Herstellung des zertifizierten Produktes wird überwacht.

This certificate is based on our Testing and Certification Regulation and states the conformity of the product with the standards and testing requirements as indicated above. Any additional requirements in countries where the product is going to be marketed have to be considered additionally. The manufacturing of the certified product is subject to surveillance.

TÜV Rheinland LGA Products GmbH - Tillystraße 2 - 90431 Nürnberg
Tel.: (+49/221)8 06 - 13 71 e-mail: cert-validity@de.tuv.com
Fax: (+49/221)8 06 - 39 35 http://www.tuv.com/safety



G. Yin

Zertifikat

Certificate



Zertifikat Nr. *Certificate No.*
R 50279350

Blatt *Page*
0003

Ihr Zeichen *Client Reference*

Unser Zeichen *Our Reference*

Ausstellungsdatum
01.02.2018

Date of Issue
(day/mo/yr)

05-YFC- 16058722 003

Genehmigungsinhaber *License Holder*

Dongguan Better Electronics
Technology Co., Ltd.
Room 601 of 16 Block, Xinzhu Yuan
No 4, Xinzhu Road, Songshan Lake
Hightech Ind. Development Zone
Dongguan City, Guangdong Province
P. R. China

Fertigungsstätte *Manufacturing Plant*

Dongguan Better Electronics
Technology Co., Ltd.
Nanmen Village, Hengkeng
Administrative Zone, Liaobu Town
Dongguan, Guangdong
P. R. China

Prüfzeichen *Test Mark*



Type Approved
Safety
Regular Production
Surveillance

www.tuv.com
ID 2000000000

Geprüft nach *Tested acc. to*

EN 60127-1:2006+A1+A2
EN 60127-7:2016

Zertifiziertes Produkt (*Geräteidentifikation*)
Certified Product (Product Identification)

Lizenzentgelte - Einheit
License Fee - Unit

Fuse Link (Miniature Fuse-link)

as pages 0001 to 0002

Change

Test Requirement : see above

Remark:

- 1) The product also comply with IEC60127-1:2006+A1+A2 and IEC60127-7:2015.
- 2) The labelling requirements acc. to EU Directive 2001/95 have to be observed for distribution within the EEA.

Dem Zertifikat liegt unsere Prüf- und Zertifizierungsordnung zugrunde und es bestätigt die Konformität des Produktes mit den oben genannten Standards und Prüfgrundlagen. Zusätzliche Anforderungen in Ländern, in denen das Produkt in Verkehr gebracht werden soll, müssen zusätzlich betrachtet werden. Die Herstellung des zertifizierten Produktes wird überwacht.
This certificate is based on our Testing and Certification Regulation and states the conformity of the product with the standards and testing requirements as indicated above. Any additional requirements in countries where the product is going to be marketed have to be considered additionally. The manufacturing of the certified product is subject to surveillance.

TÜV Rheinland LGA Products GmbH - Tillystraße 2 - 90431 Nürnberg
Tel.: (+49/221)8 06 - 13 71 e-mail: cert-validity@de.tuv.com
Fax: (+49/221)8 06 - 39 35 http://www.tuv.com/safety



GUTACHTEN MIT FERTIGUNGSÜBERWACHUNG CERTIFICATE OF CONFORMITY WITH FACTORY SURVEILLANCE

Dongguan Better Electronics
Technology Co., Ltd.
Room 601 of 16 Block, Xinzhu Yuan
No 4, Xinzhu Road
523808 DONGGUAN
CHINA

ist berechtigt, für ihr Produkt /
is authorized to use for their product

Kleinstsicherungseinsatz
Sub-miniature fuse-link

die hier abgebildeten markenrechtlich geschützten Zeichen
für die ab Blatt 2 aufgeführten Typen zu benutzen /
the legally protected Marks as shown below for the types referred to on page 2 ff.



REG.-Nr. D743 oder/or



oder/or VDE-REG.-Nr. D743

REG.-Nr. D743

Geprüft und zertifiziert nach /
Tested and certified according to

DIN EN 60127-1 (VDE 0820-1):2015-12; EN 60127-1:2006+A1:2011+A2:2015
DIN EN 60127-3 (VDE 0820-3):2015-11; EN 60127-3:2015
IEC 60127-1:2006
IEC 60127-1:2006/AMD1:2011
IEC 60127-1:2006/AMD2:2015
IEC 60127-3:2015



Aktenzeichen: 5015514-1170-0007 / 228698

File ref.:

Ausweis-Nr. 40033369

Blatt 1

Certificate No.

Page

Weitere Bedingungen siehe Rückseite und Folgeblätter /
further conditions see overleaf and following pages

Offenbach, 2011-09-19

(letzte Änderung / updated 2016-11-21)

VDE Prüf- und Zertifizierungsinstitut GmbH
VDE Testing and Certification Institute
Zertifizierungsstelle / Certification

M. Tasotti

VDE Zertifikate sind nur gültig bei Veröffentlichung unter:
VDE certificates are valid only when published on:

<http://www.vde.com/zertifikat>
<http://www.vde.com/certificate>

Name und Sitz des Genehmigungs-Inhabers / *Name and registered seat of the Certificate holder*

Dongguan Better Electronics Technology Co., Ltd., Room 601 of 16 Block, Xinzhu Road,
523808 DONGGUAN, Guangdong, CHINA

Aktenzeichen / *File ref.*

5015514-1170-0007 / 228698 / CC2 / EUL

letzte Änderung / *updated*

2016-11-21

Datum / *Date*

2011-09-19

Dieses Blatt gilt nur in Verbindung mit Blatt 1 des Gutachtens mit Fertigungsüberwachung Nr. 40033369.

This supplement is only valid in conjunction with page 1 of the Certificate of Conformity with factory surveillance No. 40033369.

Kleinleistungseinsatz *Sub-miniature fuse-link*

Typ(en) / *Type(s)*

932

Bemessungsspannung
Rated voltage

AC 250 V

Bemessungsstrom
Rated current

630 mA; 800 mA; 1 A; 1,25 A; 1,6 A; 2 A;
2,5 A; 3,15 A; 4 A; 5 A; 6,3 A

Normblatt
Standard sheet

4

Kennzeichnung der Charakteristik
Characteristic symbol

T

Bemessungsausschaltvermögen
Rated breaking capacity

35 A bzw. 10 x I_n
35 A resp. 10 x I_n

Zeit/Strom-Charakteristik
Time/current-characteristic

träge
time-lag

Anmerkung

Rechteckige Bauform.
Die Prüfspannung in Abschnitt 9.2 war DC 63 V.

Remark

*Rectangular shape.
The test voltage in clause 9.2 was DC 63 V.*

Dieser Zeichengenehmigungs-Ausweis bildet eine Grundlage für die EG-Konformitätserklärung und CE-Kennzeichnung durch den Hersteller oder dessen Bevollmächtigten und bescheinigt die Konformität mit den grundlegenden Schutzanforderungen der **EG-Niederspannungsrichtlinie 2014/35/EU**.

*This Marks Approval is a basis for the EC Declaration of Conformity and the CE Marking by the manufacturer or his agent and proves the conformity with the essential safety requirements of the **EC Low-Voltage Directive 2014/35/EU**.*

VDE Prüf- und Zertifizierungsinstitut GmbH
VDE Testing and Certification Institute
Fachgebiet CC2
Section CC2

VDE Prüf- und Zertifizierungsinstitut Gutachten mit Fertigungsüberwachung

Ausweis-Nr. / Beiblatt /
Certificate No. Supplement
40033369

Name und Sitz des Genehmigungs-Inhabers / *Name and registered seat of the Certificate holder*

Dongguan Better Electronics Technology Co., Ltd., Room 601 of 16 Block, Xinzhu Yuan, No 4, Xinzhu Road,
523808 DONGGUAN, Guangdong, CHINA

Aktenzeichen / *File ref.*

5015514-1170-0007 / 228698 / CC2 / EUL

letzte Änderung / *updated*

2016-11-21

Datum / *Date*

2011-09-19

Dieses Beiblatt ist Bestandteil des Gutachtens mit Fertigungsüberwachung Nr. 40033369.

This supplement is part of the Certificate of Conformity with factory surveillance No. 40033369.

Kleinstsicherungseinsatz

Sub-miniature fuse-link

Fertigungsstätte(n)

Place(s) of manufacture

Referenz/*Reference*

30017543

Dongguan Better Electronics
Technology Co., Ltd.
Nanmen Village
Hengkeng Administrative Zone
523413 LIAOBU TOWN, DONGGUAN
Guangdong
CHINA

VDE Prüf- und Zertifizierungsinstitut GmbH

VDE Testing and Certification Institute

Fachgebiet CC2

Section CC2

Name und Sitz des Genehmigungs-Inhabers / *Name and registered seat of the Certificate holder*

Dongguan Better Electronics Technology Co., Ltd., Room 601 of 16 Block, Xinzhu Road,
523808 DONGGUAN, Guangdong, CHINA

Aktenzeichen / *File ref.*

5015514-1170-0007 / 228698 / CC2 / EUL

letzte Änderung / *updated*

2016-11-21

Datum / *Date*

2011-09-19

Dieses Blatt gilt nur in Verbindung mit Blatt 1 des Gutachtens mit Fertigungsüberwachung Nr. 40033369.

This supplement is only valid in conjunction with page 1 of the Certificate of Conformity with factory surveillance No. 40033369.

Genehmigung zum Benutzen des auf Seite 1 abgebildeten markenrechtlich geschützten Zeichens des VDE:

Grundlage für die Benutzung sind die Allgemeinen Geschäftsbedingungen (AGB) der VDE Prüf- und Zertifizierungsinstitut GmbH (www.vde.com\AGB-Institut). Das Recht zur Benutzung erstreckt sich nur auf die bezeichnete Firma mit den genannten Fertigungsstätten und die oben aufgeführten Produkte mit den zugeordneten Bezeichnungen. Die Fertigungsstätte muss so eingerichtet sein, dass eine gleichmäßige Herstellung der geprüften und zertifizierten Ausführung gewährleistet ist.

Die Genehmigung ist so lange gültig wie die VDE-Bestimmungen gelten, die der Zertifizierung zugrunde gelegen haben, sofern sie nicht auf Grund anderer Bedingungen aus der VDE Prüf- und Zertifizierungsordnung (PM102) zurückgezogen werden muss.

Der Gültigkeitszeitraum einer VDE-GS-Zeichengenehmigung kann auf Antrag verlängert werden. Bei gesetzlichen und / oder normativen Änderungen kann die VDE-GS-Zeichengenehmigung ihre Gültigkeit zu einem früheren als dem angegebenen Datum verlieren.

Produkte, die das Biozid Dimethylfumarat (DMF) enthalten, dürfen gemäß der Kommissionsentscheidung 2009/251/EG nicht mehr in den Verkehr gebracht oder auf dem Markt bereitgestellt werden.

Der VDE-Zeichengenehmigungsausweis wird ausschließlich auf der ersten Seite unterzeichnet.

Approval to use the legally protected Mark of the VDE as shown on the first page:

Basis for the use are the general terms and conditions of the VDE Testing and Certification Institute (www.vde.com\terms-institute). The right to use the mark is granted only to the mentioned company with the named places of manufacture and the listed products with the related type references. The place of manufacture shall be equipped in a way that a constant manufacturing of the certified construction is assured.

The approval is valid as long as the VDE specifications are in force, on which the certification is based on, unless it is withdrawn according to the VDE Testing and Certification Procedure (PM102E).

The validity period of a VDE-GS-Mark Approval may be prolonged on request. In case of changes in legal and / or normative requirements, the validity period of a VDE-GS-Mark Approval may be shortened.

Products containing the biocide dimethylfumarate (DMF) may not be marketed or made available on the EC market according to the Commission Decision 2009/251/EC.

The approval is solely signed on the first page.

접수번호 : 13-012442-02
(Receipt No.)



전기용품안전인증서

Electrical Appliances Safety Certificate

안전인증번호 : SU05042-13001
(Certificate No.)

제조업자명 : Dongguan Better Electronics Technoloy Co.,Ltd
(Factory)

대표자명 : Han Lu
(President)

제조공장의 소재지 : 2nd Industrial Zone, Nanmen Village, Hengkeng, Liao Bu Town, Dongguan, Guangdong, P.R.China
(Factory Address)

제품명 : 퓨즈(Sub-miniature fuse-links)
(Product)

기본모델명 : 932 T1AL250V
(Basic Model)

정격 : AC250V, 1A
(Rating)

파생모델명 : See the attachment 2
(Series Model)

적용기준 : K60127-1(2011-12), K60127-3(2006-07)
(Standard)

「전기용품안전 관리법 시행규칙」 제6조제2항에 따라 위의 전기용품에 대하여 안전인증서를 발급합니다.

We Issue Electrical Appliances Safety Certification as above product by Article 6 Section 2 of the Electrical Appliances Safety Control Law Enforcement Regulation.

2013년 04월 12일



한국산업기술시험원장
KOREA TESTING LABORATORY



* 이 인증서는 「전기용품안전 관리법」에 따른 전기용품 안전성 확인에 한정된 것이며, 그 밖의 다른 법률이 적용되는 제품의 경우에는 해당 법률에 따라 추가로 인증·허가 등을 받아야 합니다.

- 첨부 : (Annex)
1. 안전관리부품 및 재질목록 (List of Critical Components)
 2. 기본모델·파생모델의 내용 (General Descriptions of Certified Products)
 3. 전기용품안전인증의 변경 현황 (Status of Certificate Revisions)

첨부 1 : 안전관리부품 및 재질목록
 List of Critical Components

부품명(회로기호) Component(Part no.)	제조사(상표명) Manufacturer(Brand)	모델명(형식) Model(Type)	정격 또는 특성 Rating or Characteristics	인증마크 Tested by
Not applicable				
<p><input type="checkbox"/> 유의사항 (Attention) :</p> <p>1. 안전관리부품은 전기적인 안전에 직접적인 영향을 주는 부품으로서 안전인증기관이 정기공장검사 시 확인 관리 하는 사항입니다. 따라서 상기목록에 기재된 사항을 변경하거나 또는 복수등재를 원하시는 경우는 안전인증기관에 인증변경신청을 하여야 합니다.</p> <p><i>As the "Critical components" are parts in directly related with safety, these components shall be checked during a factory inspection by the certification body. In case of applying multiful listing or changing the items above, the certification revision shall be applied.</i></p> <p>2. 인증변경신청 없이 임의로 변경하는 경우는, 전기용품안전관리법 제 8 조제 1 항의 규정에 의한 안전인증취소 사유가 됨을 유의하시기 바랍니다.</p> <p><i>The Safety Certification will be cancelled under the Safety Control Law for Electrical Appliances, Paragraph 1 of Article 8 if the contents of the Certification is altered without our authorization.</i></p>				

FP511-10-00

첨부 2 : 기본모델 · 파생모델의 내용
General description of Certified Products

파생모델명 Derivative model	기본모델과의 차이점 Differences between the basic and derivative model(s)
932 T1.25AL250V	Rated current(1.25A) is different
932 T1.6AL250V	Rated current(1.6A) is different
932 T2AL250V	Rated current(2A) is different
932 T2.5AL250V	Rated current(2.5A) is different
제품특기사항 및 시험조건 Remarks & Test conditions	
<p>1. Test Report Ref. No. : 13-012442-02 (2013.04.03.)</p> <p>2. Product Description</p> <ul style="list-style-type: none"> - T1AL250V - Rated breaking capacity : 35 A - Time-lag type - Low-breaking capacity - Standard sheet 4 <p><input type="checkbox"/> 본 제품의 시험내용에 관하여 문의하실 사항이 있으시면 아래 연락처로 문의하시기 바랍니다. 시험담당자 : 전기전자본부 광응합/부품평가센터 조인철 / (02)860-1425</p> <p><input type="checkbox"/> <i>If you have any question on product testing, please contact the person below :</i> <i>Job holder : Electrical and Electronic Division Lighting Appliance & Electrical Testing Center, INCHUL CHO/ +82 2 8601-425</i></p>	

FP511-09-00

첨부 3 : 전기용품안전인증의 변경 현황
Status of Certificate Revisions

변경발급 내용 Contents of Certificate Revisions
Not applicable

FP511-11-00

접수번호 : 13-012442-03
(Receipt No.)



전기용품안전인증서

Electrical Appliances Safety Certificate

안전인증번호 : SU05042-13002
(Certificate No.)

제조업자명 : Dongguan Better Electronics Technoloy Co.,Ltd
(Factory)

대표자명 : Han Lu
(President)

제조공장의소재지 : 2nd Industrial Zone, Nanmen Village, Hengkeng, Liao Bu Town, Dongguan, Guangdong, P.R.China
(Factory Address)

제품명 : 퓨즈(Sub-miniature fuse-links)
(Product)

기본모델명 : 932 T3.15AL250V
(Basic Model)

정격 : AC250V, 3.15A
(Rating)

파생모델명 : See the attachment 2
(Series Model)

적용기준 : K60127-1(2011-12), K60127-3(2006-07)
(Standard)

「전기용품안전 관리법 시행규칙」 제6조제2항에 따라 위의 전기용품에 대하여 안전인증서를 발급합니다.

We Issue Electrical Appliances Safety Certification as above product by Article 6 Section 2 of the Electrical Appliances Safety Control Law Enforcement Regulation.

2013년 04월 12일



한국산업기술시험원장
KOREA TESTING LABORATORY



* 이 인증서는 「전기용품안전 관리법」에 따른 전기용품 안전성 확인에 한정된 것이며, 그 밖의 다른 법률이 적용되는 제품의 경우에는 해당 법률에 따라 추가로 인증·허가 등을 받아야 합니다.

- 첨부 : (Annex)
1. 안전관리부품 및 재질목록 (List of Critical Components)
 2. 기본모델·파생모델의 내용 (General Descriptions of Certified Products)
 3. 전기용품안전인증의 변경 현황 (Status of Certificate Revisions)

첨부 1 : 안전관리부품 및 재질목록
 List of Critical Components

부품명(회로기호) Component(Part no.)	제조사(상표명) Manufacturer(Brand)	모델명(형식) Model(Type)	정격 또는 특성 Rating or Characteristics	인증마크 Tested by
Not applicable				
<p><input type="checkbox"/> 유의사항 (Attention) :</p> <p>1. 안전관리부품은 전기적인 안전에 직접적인 영향을 주는 부품으로서 안전인증기관이 정기공장검사 시 확인 관리 하는 사항입니다. 따라서 상기목록에 기재된 사항을 변경하거나 또는 복수등재를 원하시는 경우는 안전인증기관에 인증변경신청을 하여야 합니다.</p> <p><i>As the "Critical components" are parts in directly related with safety, these components shall be checked during a factory inspection by the certification body. In case of applying multiful listing or changing the items above, the certification revision shall be applied.</i></p> <p>2. 인증변경신청 없이 임의로 변경하는 경우는, 전기용품안전관리법 제 8 조제 1 항의 규정에 의한 안전인증취소 사유가 됨을 유의하시기 바랍니다.</p> <p><i>The Safety Certification will be cancelled under the Safety Control Law for Electrical Appliances, Paragraph 1 of Article 8 if the contents of the Certification is altered without our authorization.</i></p>				

FP511-10-00

첨부 2 : 기본모델 · 파생모델의 내용
General description of Certified Products

파생모델명 Derivative model	기본모델과의 차이점 Differences between the basic and derivative model(s)
932 T4AL250V	Rated current(4A) and Rated breaking capacity(40A) are different
932 T5AL250V	Rated current(5A) and Rated breaking capacity(50A) are different
932 T6.3AL250V	Rated current(6.3A) and Rated breaking capacity(63A) are different
제품특기사항 및 시험조건 Remarks & Test conditions	
<p>1. Test Report Ref. No. : 13-012442-03 (2013.04.03.)</p> <p>2. Product Description</p> <ul style="list-style-type: none"> - T3.15AL250V - Rated breaking capacity : 35 A - Time-lag type - Low-breaking capacity - Standard sheet 4 <p><input type="checkbox"/> 본 제품의 시험내용에 관하여 문의하실 사항이 있으시면 아래 연락처로 문의하시기 바랍니다. 시험담당자 : 전기전자본부 광융합/부품평가센터 조인철 / (02)860-1425</p> <p><input type="checkbox"/> <i>If you have any question on product testing, please contact the person below :</i> <i>Job holder : Electrical and Electronic Division Lighting Appliance & Electrical Testing Center, INCHUL CHO/</i> <i>+82 2 8601-425</i></p>	

FP511-09-00

첨부 3 : 전기용품안전인증의 변경 현황
Status of Certificate Revisions

변경발급 내용 Contents of Certificate Revisions
Not applicable

FP511-11-00

접수번호 : 13-012442-01
(Receipt No.)



전기용품 안전 인증서

Electrical Appliances Safety Certificate

안전인증번호 : SU05042-13003
(Certificate No.)

제조업자명 : Dongguan Better Electronics Technoloy Co.,Ltd
(Factory)

대표자명 : Han Lu
(President)

제조공장의 소재지 : 2nd Industrial Zone, Nanmen Village, Hengkeng,
(Factory Address) Liao Bu Town, Dongguan, Guangdong, P.R.China

제품명 : 퓨즈(Sub-miniature fuse-links)
(Product) (Fuse)

기본모델명 : 932 T500mAL250V
(Basic Model)

정격 : AC 250 V 500 mA
(Rating)

파생모델명 : 932 T630mAL250V, 932 T800mAL250V
(Series Model)

적용기준 : K60127-1(2011-12), K60127-3(2006-07)
(Standard)

「전기용품안전 관리법 시행규칙」 제6조제2항에 따라 위의 전기용품에 대하여 안전인증서를 발급합니다.

We Issue Electrical Appliances Safety Certification as above product by Article 6 Section 2 of the Electrical Appliances Safety Control Law Enforcement Regulation.

2013년 05월 07일



한국산업기술시험원장
KOREA TESTING LABORATORY



* 이 인증서는 「전기용품안전 관리법」에 따른 전기용품 안전성 확인에 한정된 것이며, 그 밖의 다른 법률이 적용되는 제품의 경우에는 해당 법률에 따라 추가로 인증·허가 등을 받아야 합니다.

- 첨부 : (Annex)
1. 안전관리부품 및 재질목록 (List of Critical Components)
 2. 기본모델·파생모델의 내용 (General Descriptions of Certified Products)
 3. 전기용품안전인증의 변경 현황 (Status of Certificate Revisions)

첨부 1 : 안전관리부품 및 재질목록
 List of Critical Components

부품명(회로기호) Component(Part no.)	제조사(상표명) Manufacturer(Brand)	모델명(형식) Model(Type)	정격 또는 특성 Rating or Characteristics	인증마크 Tested by
Not applicable				
<p><input type="checkbox"/> 유의사항 (Attention) :</p> <p>1. 안전관리부품은 전기적인 안전에 직접적인 영향을 주는 부품으로서 안전인증기관이 정기공장검사 시 확인 관리 하는 사항입니다. 따라서 상기목록에 기재된 사항을 변경하거나 또는 복수등재를 원하시는 경우는 안전인증기관에 인증변경신청을 하여야 합니다.</p> <p><i>As the "Critical components" are parts in directly related with safety, these components shall be checked during a factory inspection by the certification body. In case of applying multiful listing or changing the items above, the certification revision shall be applied.</i></p> <p>2. 인증변경신청 없이 임의로 변경하는 경우는, 전기용품안전관리법 제 8 조제 1 항의 규정에 의한 안전인증취소 사유가 됨을 유의하시기 바랍니다.</p> <p><i>The Safety Certification will be cancelled under the Safety Control Law for Electrical Appliances, Paragraph 1 of Article 8 if the contents of the Certification is altered without our authorization.</i></p>				

FP511-10-00

첨부 2 : 기본모델 · 파생모델의 내용
General description of Certified Products

파생모델명 Derivative model	기본모델과의 차이점 Differences between the basic and derivative model(s)
932 T630mAL250V	Rated current(630mA) is different
932 T800mAL250V	Rated current(800mA) is different
제품특기사항 및 시험조건 Remarks & Test conditions	
<p>1. Test Report Ref. No. : 13-012442-01 (2013.04.03.)</p> <p>2. Product Description</p> <ul style="list-style-type: none"> - T500mAL250V - Rated breaking capacity : 35 A - Time-lag type - Low-breaking capacity - Standard sheet 4 	
<p><input type="checkbox"/> 본 제품의 시험내용에 관하여 문의하실 사항이 있으시면 아래 연락처로 문의하시기 바랍니다. 시험담당자 : 전기전자본부 광융합/부품평가센터 조인철 / (02)860-1425</p> <p><input type="checkbox"/> <i>If you have any question on product testing, please contact the person below :</i> <i>Job holder : Electrical and Electronic Division Lighting Appliance & Electrical Testing Center, INCHUL CHO/</i> <i>+82 2 8601-425</i></p>	

FP511-09-00

첨부 3 : 전기용품안전인증의 변경 현황
Status of Certificate Revisions

변경발급 내용 Contents of Certificate Revisions
Not applicable

FP511-11-00



By Royal Charter

Kitemark™ Certificate

This is to certify that:

Dongguan Better Electronics Technology
Co., Ltd.
Room 601 of 16 Block, Xinzhu Yuan
No. 4, Xinzhu Road, Songshan Lake
Hightech Industrial Development Zone
Dongguan
Guangdong
523808
China

Holds Certificate Number:

KM 677189

In respect of:

BS EN 60127
Cartridge fuse-links

This issues the right and licence to use the Kitemark in accordance with the Kitemark Terms and Conditions governing the use of the Kitemark, as may be updated from time to time by BSI Assurance UK Ltd (the "Conditions"). All defined terms in this Certificate shall have the same meaning as in the Conditions.

The use of the Kitemark is authorized in respect of the Product(s) detailed on this Certificate provided at or from the above address.

For and on behalf of BSI:

Gary Fenton, Global Product Certification Director

First Issued: 2017-09-19

Latest Issue: 2017-09-19



Page: 1 of 3

...making excellence a habit.™

This certificate has been issued by and remains the property of BSI Assurance UK Ltd, Kitemark Court, Davy Avenue, Knowlhill, Milton Keynes MK5 8PP, United Kingdom and should be returned immediately upon request. To check its validity telephone +44 (0) 345 080 9000. An electronic certificate can be authenticated [online](#).

BSI Assurance UK Limited, registered in England under number 7805321 at 389 Chiswick High Road, London W4 4AL, UK.
A member of BSI Group of Companies.

Kitemark™ Certificate

No. KM 677189

Group 2: Miniature fuses - sub-miniature fuse-links, Standard Sheet 4, BS EN 60127-3:2015
(BS EN 60127-1:2006+A2:2015)

Series 932, time-lag, low breaking capacity.		
Rating	CB Reference Reports	Additional reference reports
T3.15AL250V	CVC2017-0474/1	Not applicable.
T5AL250V	CVC2017-0474/2	
T8AL250V	CVC2017-0474/3	
T10AL250V	CVC2017-0474/4	

Products listed on the Kitemark licence are manufactured at the following location:

Dongguan Better Electronics Technology Co., Ltd.
Nanmen Village, Hengkeng Administrative Zone
Liaobu Town
Dongguan
Guangdong
523413
China

First Issued: 2017-09-19

Latest Issue: 2017-09-19

Page: 3 of 3

This certificate has been issued by and remains the property of BSI Assurance UK Ltd, Kitemark Court, Davy Avenue, Knowlhill, Milton Keynes MK5 8PP, United Kingdom and should be returned immediately upon request.
To check its validity telephone +44 (0) 345 080 9000. An electronic certificate can be authenticated [online](#).

BSI Assurance UK Limited, registered in England under number 7805321 at 389 Chiswick High Road, London W4 4AL, UK.
A member of BSI Group of Companies.

Certificate



for European Product Safety

Reference No. 1719061

Sub-miniature fuse-link

Type designation 932 T3.15AL250V, 932 T5AL250V, 932 T8AL250V, 932 T10AL250V

Certificate holder **Dongguan Better Electronics Technology Co.
Ltd, Room601of16 Block, Xinzhu Yuan
No. 4, Xinzhu Road, Songshanlake
Hightech Ind. Devel. Zone Dongguan
City, Guangdong Province, 523808
CHINA**

*The product complies with
the standard(s)* EN 60127-3:2015

Date of expiry 2 November 2022

EU Directive information According to the principle of presumption of conformity, this certificate constitutes support for an EC Declaration of Conformity and CE marking according to the Low Voltage Directive 2014/35/EU.

Additional information in Appendix.

Certification Body Intertek Semko AB, Product Certification *Place* Kista - Stockholm

Signed 
Bo Berglöf *Date* 6 November 2017
Page 1 of 2

This certificate is issued in accordance with the terms and conditions set out in the Appendix.



Intertek Appendix

Reference No. 1719061

Technical data

Type designation	932 T3.15AL250V, 932 T5AL250V, 932 T8AL250V, 932 T10AL250V			
Rated voltage (V)	250V			
Rated current (A)	3,15A	5A	8A	10A
Standard sheet	4			
Trademark:	ⓑ			
Product information	Sub-miniature fuse-link. Time-lag, Low-breaking capacity.			

Manufacturing site(s) Dongguan Better Electronics Technology Co. Ltd., Nanmen Village, Hengkeng Administrative Zone, Liaobu Town, Dongguan, Guangdong, 523413 CHINA

According to the principle of presumption of conformity, this certificate, which includes production control, constitutes support for an EC Declaration of Conformity and CE marking according to the Low Voltage Directive 2014/35/EU.

This presumption can expire before end of validity of this certificate due to new issued Standard or Amendment and changes within the EU legislation.

This certificate is based on CB with ref. No. CN40983 dated 17 August 2017, issued by CQC.

This certificate replaces previously issued ref. No. 1717501 dated 2 November 2017.

A new certificate has been issued on account of correction of the manufacturing site address.

<i>Certification Body</i>	Intertek Semko AB, Product Certification	<i>Place</i>	Kista - Stockholm
---------------------------	--	--------------	-------------------

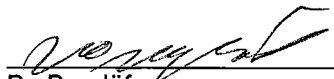
<i>Signed</i>	 Bo Berglöf	<i>Date</i>	6 November 2017
---------------	---	-------------	-----------------

This Certificate is for the exclusive use of Intertek's Client and is provided pursuant to the Certification agreement between Intertek and its Client. Intertek's responsibility and liability are limited to the terms and conditions of the agreement. Intertek assumes no liability to any party, other than to the Client in accordance with the agreement, for any loss, expense or damage occasioned by the use of this certificate. Only the Client is authorized to permit copying or distribution of this certificate and then only in its entirety. Use of Intertek's Certification mark is restricted to the conditions laid out in the agreement. Any further use of the Intertek name for the sale or advertisement of the tested material, product or service must first be approved in writing by Intertek. Initial Factory Assessments and Follow up Services are for the purpose of assuring appropriate usage of the Certification mark in accordance with the agreement, they are not for the purposes of production quality control and do not relieve the Client of their obligations in this respect.

ASF