

SECT B-B

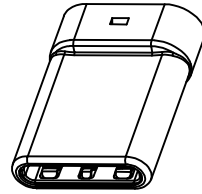

P/N	R/C
U261-24XXN-4B0284	C1 (10nF)

U261-24XXN-4B0284

- 1: Au
- 2: Ni
- 1: Au1u"
- 2: Au3u"
- 4: Au15u"
- 5: Au30u"

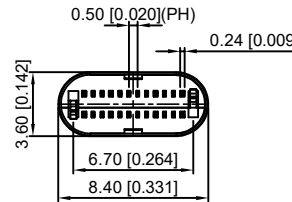
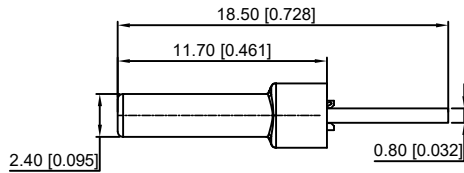
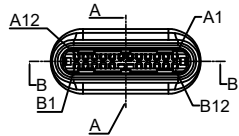
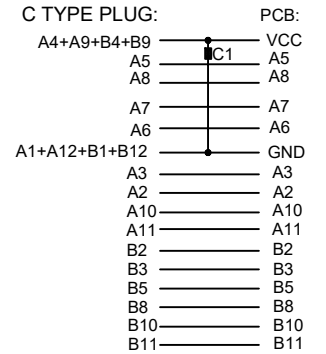

REMARKS:

- CONTACT INSERTION AND WITHDRAW FORCE :
 - Insertion force: 5N-20N max.
 - Withdrawal force: 8N-20N.
 - Durability : 10000Cycles.
- ELECTRIC PROPERTY :
 - Contact current rating: 3A.
 - Dielectric Strength: 100V AC(RMS).
 - Insulation Resistance: 100 megaohms min.
 - Contact resistance:
 - 40m0hms MAX.FOR VBUS,GND AND OTHER CONTACT
 - 50m0hms MAX.AFTER ENVIRONMENT TEST
- AMBIENT TEMPERATURE :
 - Operating temperature: -55°C to +85°C.

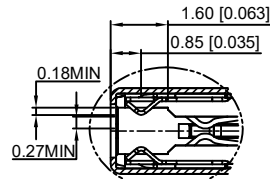
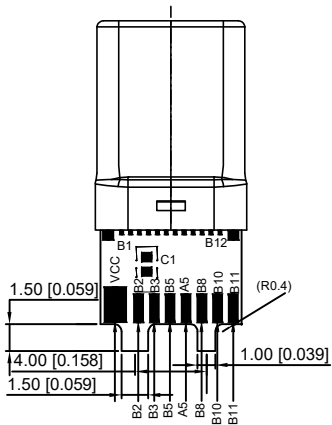

D
2:1

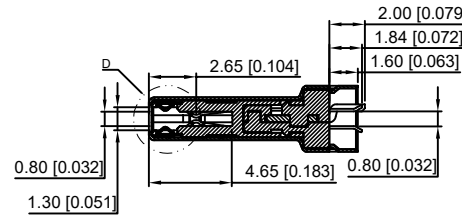

SECT A-A

A12	A11	A10	A9	A8	A7	A6	A5	A4	A3	A2	A1
GND	RX2+	RX2-	Vbus	SBU1	D-	D+	CC	Vbus	TX1-	TX1+	GND
GND	TX2+	TX2-	Vbus	Vconn			SBU2	Vbus	RX1-	RX1+	GND
B1	B2	B3	B4	B5	B6	B7	B8	B9	B10	B11	B12

6	Shrapnel	SUS T=0.10mm	
5	Shell	SUS T=0.15mm	Ovep-plating: Ni
4	Terminal	C7025 T=0.15mm	Ovep-plating: Au Ni/Sn
3	Latch	SUS T=0.4mm	
2	Housing	LCP	UL94-0
1	Housing Stopper	LCP	UL94-0
ITEM	DESCRIPTION	MATERIAL	REMARKS

DSND		DATE		SCALE: N/A	MODEL TYPE: 3.1 TYPE C	
DWN		DATE		VIEW:	PART NO.:	
CHKD		DATE		UNIT: mm/in	DWG NO.:	
APPD		DATE		SIZE: A4	U261-24XXN-4B0284	
				WEIGHT	SHEET	REVISION
				1.0g	1/1	A0

XKB INDUSTRIAL PRECISION CO., LIMITED

Δx					ANGLAR	±5°
Δx					L ≤ 4	±0.2
Δx					4 < L ≤ 16	±0.3
MARK	DESCRIPTION	DATE	REVISED	APPROVED	16 < L ≤ 63	±0.4
					L > 63	±0.5
REVISIONS						UNSPECIFIED TOLERANCES
www.xk-dg.cn www.helloxkb.com www.helloxkb.cn						