

# MOSFET - N-Channel Shielded Gate PowerTrench®

150 V, 7.3 mΩ, 101 A

## NTP7D3N15MC

### Features

- Shielded Gate MOSFET Technology
- Max  $R_{DS(on)} = 7.3 \text{ m}\Omega$  at  $V_{GS} = 10 \text{ V}$ ,  $I_D = 62 \text{ A}$
- 50% Lower  $Q_{rr}$  than other MOSFET Suppliers
- Lowers Switching Noise/EMI
- 100% UIL Tested
- These Devices are Pb-Free, Halogen Free/BFR Free and are RoHS Compliant

### Typical Applications

- Synchronous Rectification for ATX / Server / Telecom PSU
- Motor Drives and Uninterruptible Power Supplies
- Micro Solar Inverter

### MAXIMUM RATINGS ( $T_J = 25^\circ\text{C}$ unless otherwise noted)

Parameter	Symbol	Value	Unit
Drain-to-Source Voltage	$V_{DSS}$	150	V
Gate-to-Source Voltage	$V_{GS}$	$\pm 20$	V
Continuous Drain Current $R_{\theta JC}$ (Note 2)	$I_D$	101	A
Power Dissipation $R_{\theta JC}$ (Note 2)			
Continuous Drain Current $R_{\theta JA}$ (Notes 1, 2)	$I_D$	12.1	A
Power Dissipation $R_{\theta JA}$ (Notes 1, 2)			
Pulsed Drain Current	$I_{DM}$	574	A
Operating Junction and Storage Temperature Range	$T_J, T_{stg}$	-55 to +175	$^\circ\text{C}$
Single Pulse Drain-to-Source Avalanche Energy ( $I_L = 20 \text{ A}_{pk}$ , $L = 3 \text{ mH}$ )	$E_{AS}$	600	mJ
Lead Temperature for Soldering Purposes (1/8" from case for 10 s)	$T_L$	260	$^\circ\text{C}$

Stresses exceeding those listed in the Maximum Ratings table may damage the device. If any of these limits are exceeded, device functionality should not be assumed, damage may occur and reliability may be affected.

1. Surface-mounted on FR4 board using a 1 in<sup>2</sup>, 2 oz. Cu pad.
2. The entire application environment impacts the thermal resistance values shown, they are not constants and are only valid for the particular conditions noted.



ON Semiconductor®

[www.onsemi.com](http://www.onsemi.com)

$V_{(BR)DSS}$	$R_{DS(ON)} \text{ MAX}$	$I_D \text{ MAX}$
150 V	7.3 mΩ @ 10 V	101 A

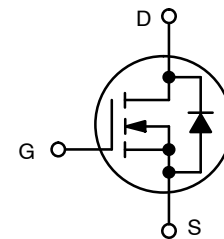

N-CHANNEL MOSFET

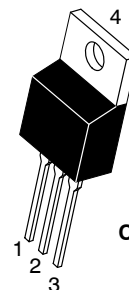

TO-220  
CASE 221A

### MARKING DIAGRAM

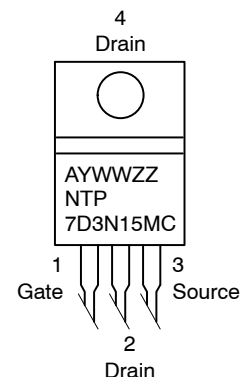

NTP7D3N15MC = Specific Device Code  
 A = Assembly Location  
 Y = Year  
 WW = Work Week  
 ZZ = Lot Traceability

### ORDERING INFORMATION

Device	Package	Shipping†
NTP7D3N15MC	TO-220 (Pb-Free)	800 / Tube

†For information on tape and reel specifications, including part orientation and tape sizes, please refer to our Tape and Reel Packaging Specifications Brochure, BRD8011/D.

# NTP7D3N15MC

## Thermal Resistance Maximum Ratings

Parameter	Symbol	Value	Unit
Junction-to-Case – Steady State (Note 2)	$R_{\theta JC}$	0.9	°C/W
Junction-to-Ambient – Steady State (Note 2)	$R_{\theta JA}$	62.5	

## Electrical Characteristics (T<sub>J</sub> = 25°C unless otherwise specified)

Parameter	Symbol	Test Condition	Min	Typ	Max	Unit
-----------	--------	----------------	-----	-----	-----	------

### OFF CHARACTERISTICS

Drain-to-Source Breakdown Voltage	$V_{(BR)DSS}$	$V_{GS} = 0\text{ V}, I_D = 250\ \mu\text{A}$	150			V
Drain-to-Source Breakdown Voltage Temperature Coefficient	$V_{(BR)DSS}/T_J$	$I_D = 250\ \mu\text{A}, \text{ref to } 25^\circ\text{C}$		71		mV/°C
Zero Gate Voltage Drain Current	$I_{DSS}$	$V_{GS} = 0\text{ V}, V_{DS} = 120\text{ V}$ $T_J = 25^\circ\text{C}$			1.0	μA
Gate-to-Source Leakage Current	$I_{GSS}$	$V_{DS} = 0\text{ V}, V_{GS} = \pm 20\text{ V}$			±100	nA

### ON CHARACTERISTICS

Gate Threshold Voltage	$V_{GS(TH)}$	$V_{GS} = V_{DS}, I_D = 342\ \mu\text{A}$	2.5		4.5	V
Negative Threshold Temperature Coefficient	$V_{GS(TH)}/T_J$	$I_D = 342\ \mu\text{A}, \text{ref to } 25^\circ\text{C}$		-7.3		mV/°C
Drain-to-Source On Resistance	$R_{DS(on)}$	$V_{GS} = 10\text{ V}, I_D = 62\text{ A}$		6.2	7.3	mΩ
		$V_{GS} = 8\text{ V}, I_D = 31\text{ A}$		6.6	8.4	
Forward Transconductance	$g_{FS}$	$V_{DS} = 10\text{ V}, I_D = 62\text{ A}$		119		S

### CHARGES, CAPACITANCES & GATE RESISTANCE

Input Capacitance	$C_{ISS}$	$V_{GS} = 0\text{ V}, f = 1\text{ MHz}, V_{DS} = 75\text{ V}$		4250		pF
Output Capacitance	$C_{OSS}$			1250		
Reverse Transfer Capacitance	$C_{RSS}$			15		
Gate-Resistance	$R_G$			0.8	1.6	Ω
Total Gate Charge	$Q_{G(TOT)}$	$V_{GS} = 10\text{ V}, V_{DS} = 75\text{ V}; I_D = 62\text{ A}$		53		nC
Threshold Gate Charge	$Q_{G(TH)}$			14		
Gate-to-Source Charge	$Q_{GS}$			23		
Gate-to-Drain Charge	$Q_{GD}$			8.5		
Plateau Voltage	$V_{GP}$			5.8		
Output Charge	$Q_{OSS}$	$V_{DD} = 75\text{ V}, V_{GS} = 0\text{ V}$		133		nC

### SWITCHING CHARACTERISTICS (Note 3)

Turn-On Delay Time	$t_{d(ON)}$	$V_{GS} = 10\text{ V}, V_{DD} = 75\text{ V}, I_D = 62\text{ A}, R_G = 4.7\ \Omega$		27		ns
Rise Time	$t_r$			8.5		
Turn-Off Delay Time	$t_{d(OFF)}$			33		
Fall Time	$t_f$			5.8		

### DRAIN-SOURCE DIODE CHARACTERISTICS

Forward Diode Voltage	$V_{SD}$	$V_{GS} = 0\text{ V}, I_S = 62\text{ A}$	$T_J = 25^\circ\text{C}$		0.93	1.2	V
Reverse Recovery Time	$t_{RR}$	$V_{GS} = 0\text{ V}, V_{DD} = 75\text{ V}$ $di_S/dt = 300\text{ A}/\mu\text{s}, I_S = 62\text{ A}$			55		ns
Reverse Recovery Charge	$Q_{RR}$				247		nC
Reverse Recovery Time	$t_{RR}$	$V_{GS} = 0\text{ V}, V_{DD} = 75\text{ V}$ $di_S/dt = 1000\text{ A}/\mu\text{s}, I_S = 62\text{ A}$			50		ns
Reverse Recovery Charge	$Q_{RR}$				720		nC

Product parametric performance is indicated in the Electrical Characteristics for the listed test conditions, unless otherwise noted. Product performance may not be indicated by the Electrical Characteristics if operated under different conditions.

3. Switching characteristics are independent of operating junction temperatures.

# NTP7D3N15MC

## TYPICAL CHARACTERISTICS

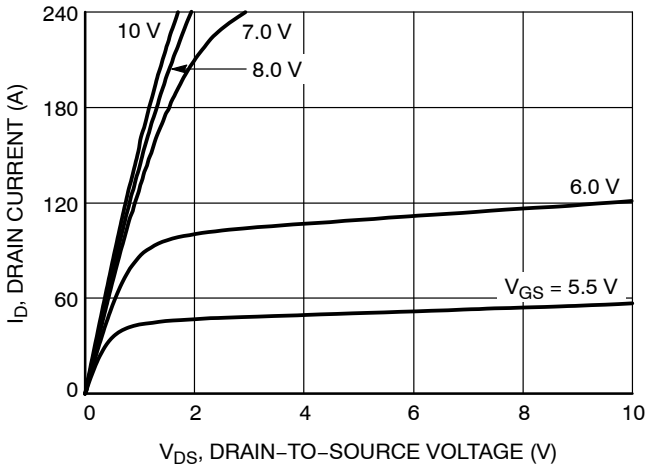

Figure 1. On-Region Characteristics

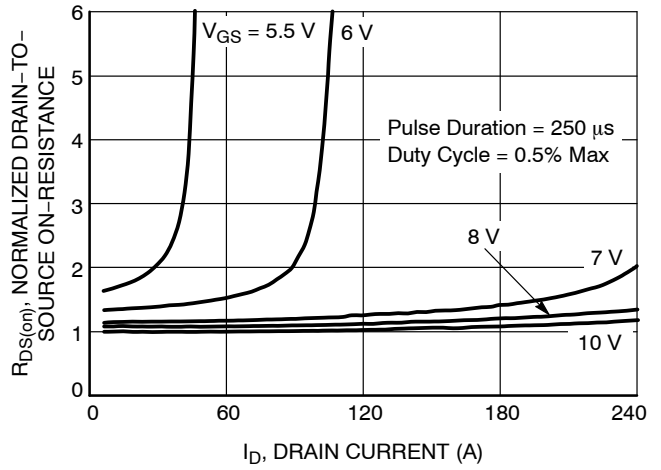

Figure 2. Normalized On-Resistance vs. Drain Current and Gate Voltage

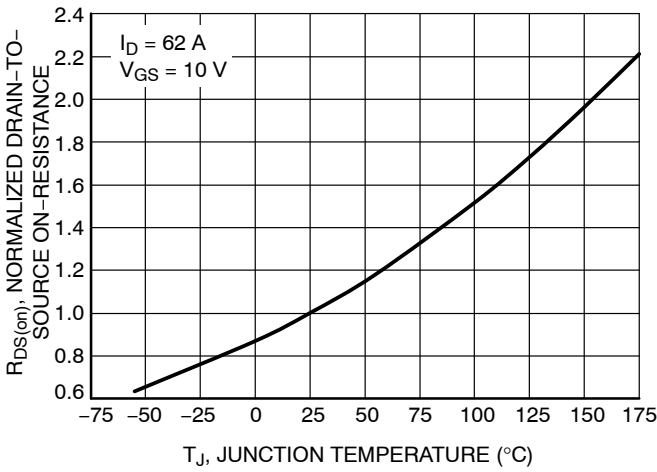

Figure 3. Normalized On-Resistance vs. Junction Temperature

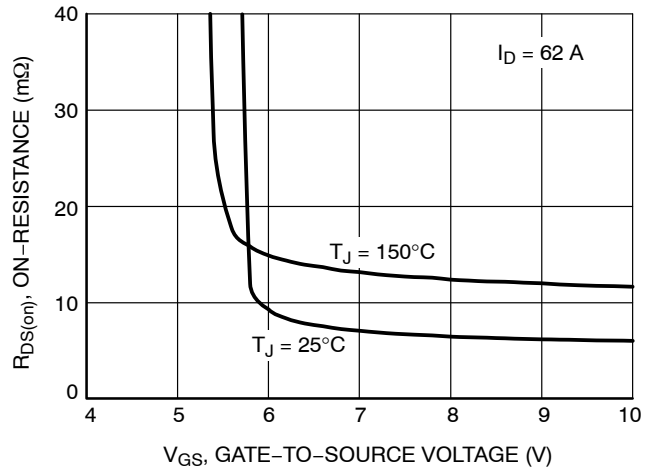

Figure 4. On-Resistance vs. Gate-to-Source Voltage

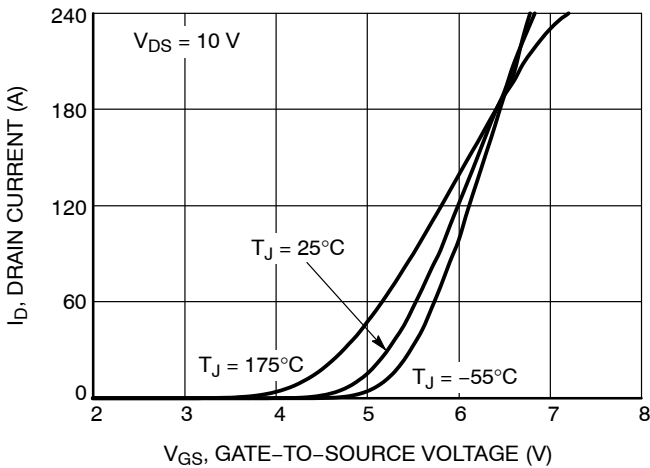

Figure 5. Transfer Characteristics

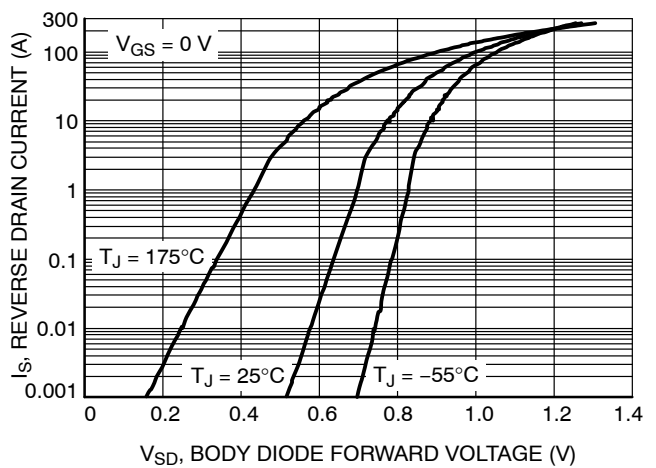

Figure 6. Source-to-Drain Diode Forward Voltage vs. Source Current

# NTP7D3N15MC

## TYPICAL CHARACTERISTICS

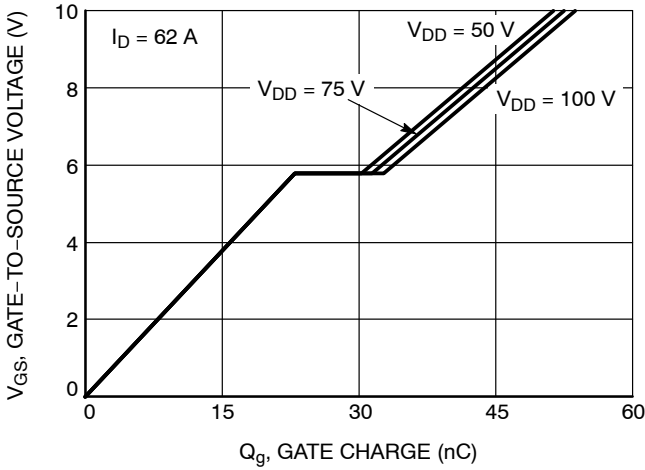

Figure 7. Gate Charge Characteristics

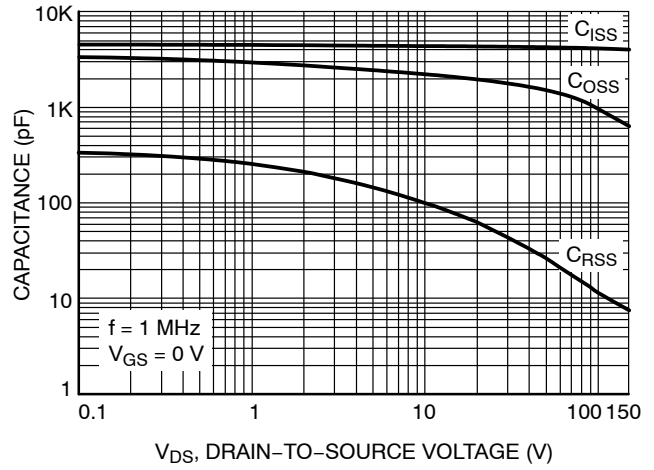

Figure 8. Capacitance vs. Drain-to-Source Voltage

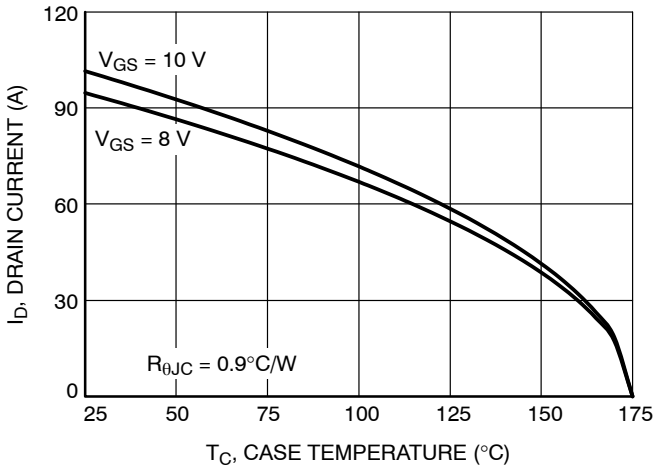

Figure 9. Drain Current vs. Case Temperature

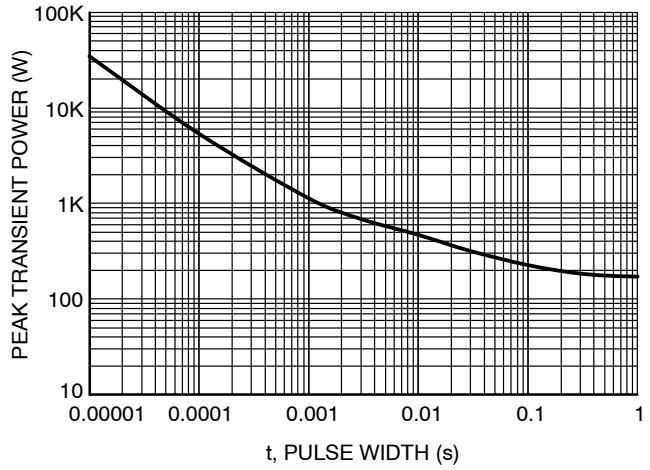

Figure 10. Peak Power

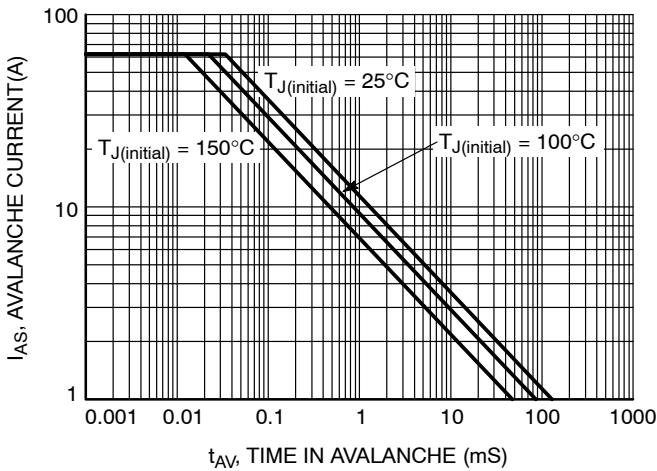

Figure 11. Unclamped Inductive Switching Capability

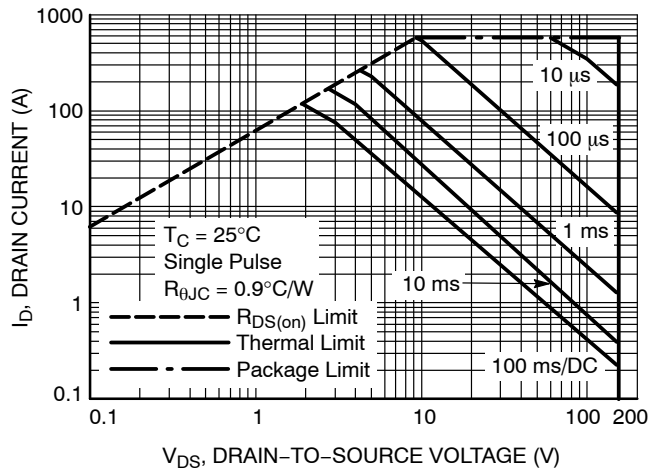

Figure 12. Forward Bias Safe Operating Area

# NTP7D3N15MC

## TYPICAL CHARACTERISTICS

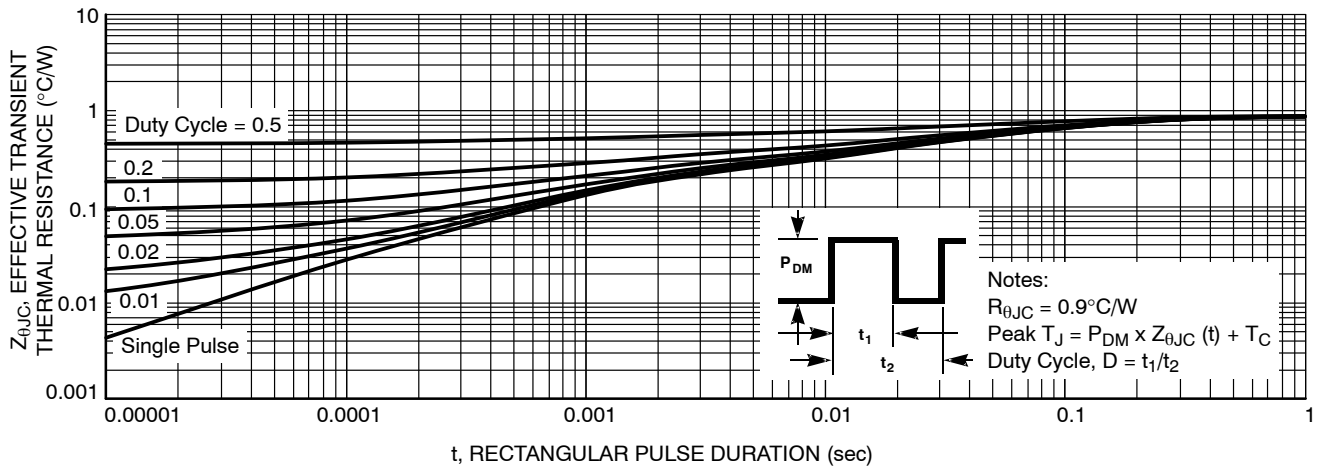

Figure 13. Transient Thermal Impedance

# MECHANICAL CASE OUTLINE

## PACKAGE DIMENSIONS

ON Semiconductor®



SCALE 1:1

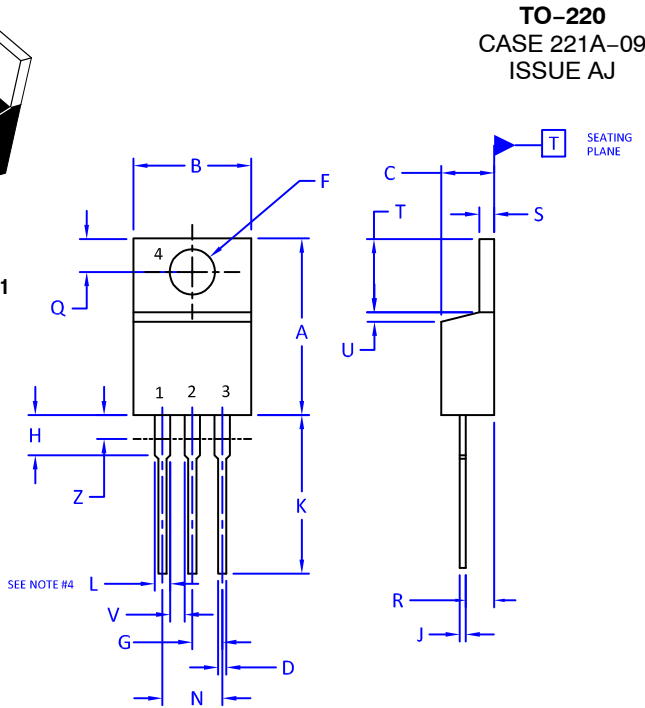

**TO-220**  
CASE 221A-09  
ISSUE AJ

DATE 05 NOV 2019

**NOTES:**

1. DIMENSIONING AND TOLERANCING PER ANSI Y14.5M, 2009.
2. CONTROLLING DIMENSION: INCHES
3. DIMENSION Z DEFINES A ZONE WHERE ALL BODY AND LEAD IRREGULARITIES ARE ALLOWED.
4. MAX WIDTH FOR F102 DEVICE = 1.35MM

DIM	INCHES		MILLIMETERS	
	MIN.	MAX.	MIN.	MAX.
A	0.570	0.620	14.48	15.75
B	0.380	0.415	9.66	10.53
C	0.160	0.190	4.07	4.83
D	0.025	0.038	0.64	0.96
F	0.142	0.161	3.60	4.09
G	0.095	0.105	2.42	2.66
H	0.110	0.161	2.80	4.10
J	0.014	0.024	0.36	0.61
K	0.500	0.562	12.70	14.27
L	0.045	0.060	1.15	1.52
N	0.190	0.210	4.83	5.33
Q	0.100	0.120	2.54	3.04
R	0.080	0.110	2.04	2.79
S	0.045	0.055	1.15	1.41
T	0.235	0.255	5.97	6.47
U	0.000	0.050	0.00	1.27
V	0.045	---	1.15	---
Z	---	0.080	---	2.04

**STYLE 1:**

- PIN 1. BASE
- 2. COLLECTOR
- 3. EMITTER
- 4. COLLECTOR

**STYLE 2:**

- PIN 1. BASE
- 2. EMITTER
- 3. COLLECTOR
- 4. EMITTER

**STYLE 3:**

- PIN 1. CATHODE
- 2. ANODE
- 3. GATE
- 4. ANODE

**STYLE 4:**

- PIN 1. MAIN TERMINAL 1
- 2. MAIN TERMINAL 2
- 3. GATE
- 4. MAIN TERMINAL 2

**STYLE 5:**

- PIN 1. GATE
- 2. DRAIN
- 3. SOURCE
- 4. DRAIN

**STYLE 6:**

- PIN 1. ANODE
- 2. CATHODE
- 3. ANODE
- 4. CATHODE

**STYLE 7:**

- PIN 1. CATHODE
- 2. ANODE
- 3. CATHODE
- 4. ANODE

**STYLE 8:**

- PIN 1. CATHODE
- 2. ANODE
- 3. EXTERNAL TRIP/DELAY
- 4. ANODE

**STYLE 9:**

- PIN 1. GATE
- 2. COLLECTOR
- 3. EMITTER
- 4. COLLECTOR

**STYLE 10:**

- PIN 1. GATE
- 2. SOURCE
- 3. DRAIN
- 4. SOURCE

**STYLE 11:**

- PIN 1. DRAIN
- 2. SOURCE
- 3. GATE
- 4. SOURCE

**STYLE 12:**

- PIN 1. MAIN TERMINAL 1
- 2. MAIN TERMINAL 2
- 3. GATE
- 4. NOT CONNECTED

<b>DOCUMENT NUMBER:</b>	<b>98ASB42148B</b>	Electronic versions are uncontrolled except when accessed directly from the Document Repository. Printed versions are uncontrolled except when stamped "CONTROLLED COPY" in red.
<b>DESCRIPTION:</b>	<b>TO-220</b>	<b>PAGE 1 OF 1</b>

ON Semiconductor and are trademarks of Semiconductor Components Industries, LLC dba ON Semiconductor or its subsidiaries in the United States and/or other countries. ON Semiconductor reserves the right to make changes without further notice to any products herein. ON Semiconductor makes no warranty, representation or guarantee regarding the suitability of its products for any particular purpose, nor does ON Semiconductor assume any liability arising out of the application or use of any product or circuit, and specifically disclaims any and all liability, including without limitation special, consequential or incidental damages. ON Semiconductor does not convey any license under its patent rights nor the rights of others.

**onsemi**, **Onsemi**, and other names, marks, and brands are registered and/or common law trademarks of Semiconductor Components Industries, LLC dba "**onsemi**" or its affiliates and/or subsidiaries in the United States and/or other countries. **onsemi** owns the rights to a number of patents, trademarks, copyrights, trade secrets, and other intellectual property. A listing of **onsemi**'s product/patent coverage may be accessed at [www.onsemi.com/site/pdf/Patent-Marking.pdf](http://www.onsemi.com/site/pdf/Patent-Marking.pdf). **onsemi** reserves the right to make changes at any time to any products or information herein, without notice. The information herein is provided "as-is" and **onsemi** makes no warranty, representation or guarantee regarding the accuracy of the information, product features, availability, functionality, or suitability of its products for any particular purpose, nor does **onsemi** assume any liability arising out of the application or use of any product or circuit, and specifically disclaims any and all liability, including without limitation special, consequential or incidental damages. Buyer is responsible for its products and applications using **onsemi** products, including compliance with all laws, regulations and safety requirements or standards, regardless of any support or applications information provided by **onsemi**. "Typical" parameters which may be provided in **onsemi** data sheets and/or specifications can and do vary in different applications and actual performance may vary over time. All operating parameters, including "Typicals" must be validated for each customer application by customer's technical experts. **onsemi** does not convey any license under any of its intellectual property rights nor the rights of others. **onsemi** products are not designed, intended, or authorized for use as a critical component in life support systems or any FDA Class 3 medical devices or medical devices with a same or similar classification in a foreign jurisdiction or any devices intended for implantation in the human body. Should Buyer purchase or use **onsemi** products for any such unintended or unauthorized application, Buyer shall indemnify and hold **onsemi** and its officers, employees, subsidiaries, affiliates, and distributors harmless against all claims, costs, damages, and expenses, and reasonable attorney fees arising out of, directly or indirectly, any claim of personal injury or death associated with such unintended or unauthorized use, even if such claim alleges that **onsemi** was negligent regarding the design or manufacture of the part. **onsemi** is an Equal Opportunity/Affirmative Action Employer. This literature is subject to all applicable copyright laws and is not for resale in any manner.

## PUBLICATION ORDERING INFORMATION

### LITERATURE FULFILLMENT:

Email Requests to: [orderlit@onsemi.com](mailto:orderlit@onsemi.com)

**onsemi Website:** [www.onsemi.com](http://www.onsemi.com)

### TECHNICAL SUPPORT

**North American Technical Support:**

Voice Mail: 1 800-282-9855 Toll Free USA/Canada

Phone: 011 421 33 790 2910

**Europe, Middle East and Africa Technical Support:**

Phone: 00421 33 790 2910

For additional information, please contact your local Sales Representative