



**PARA LIGHT ELECTRONICS CO., LTD.**  
4F, No.1, Lane 93, Chien Yi Road, Chung Ho City, Taipei, Taiwan.  
Tel: 886-2-2225-3733 Fax: 886-2-2225-4800  
E-mail: [para@para.com.tw](mailto:para@para.com.tw) <http://www.para.com.tw>

## DATA SHEET

PART NO. : B-1822Y

REV : A / 1

---

CUSTOMER'S APPROVAL : \_\_\_\_\_

DCC : \_\_\_\_\_

DRAWING NO. : DS-17-16-0216G

DATE : 2017-01-20

Page : 1

LD-R/RD012



20.0mm x 16.0mm SQUARE LIGHT BAR

B-1822Y

REV: A / 1

PACKAGE DIMENSIONS

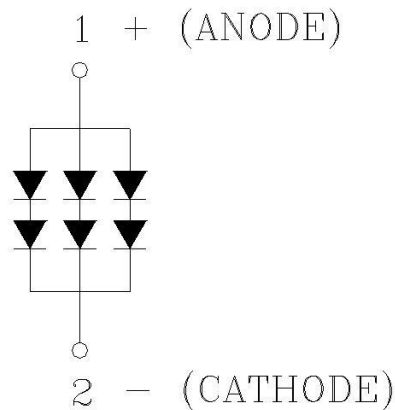
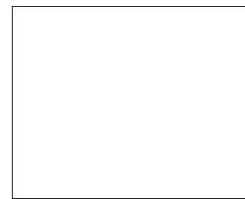
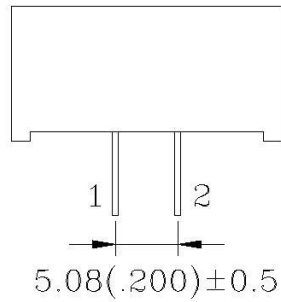
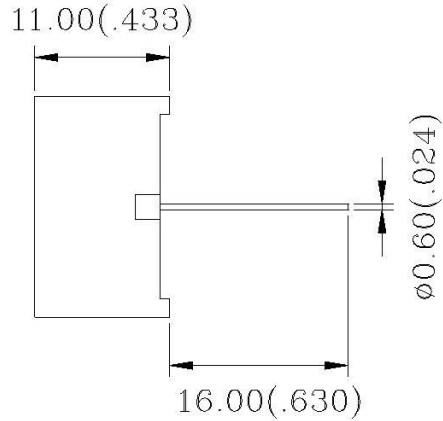
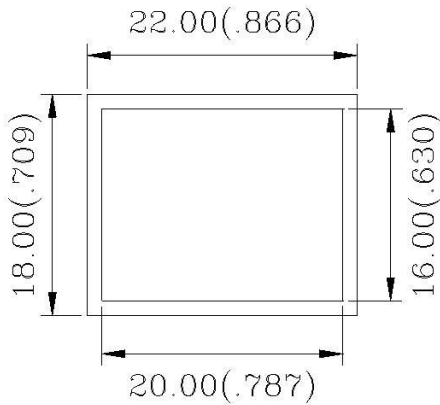

NOTES : 1. All dimensions are in millimeters. (inches)  
2. Tolerance is  $\pm 0.25(0.010)$  unless otherwise specified.



**20.0mm x 16.0mm SQUARE LIGHT BAR**

**B-1822Y**

**REV: A / 1**

**FEATURES**

- 20.0mm x 16.0mm SQUARE LIGHT BAR
- LOW POWER REQUIREMENT
- CAN BE USED WITH PANEL AND LEGEND MOUNT
- SUITABLE FOR MULTIPLEX OPERATION
- EASY MOUNTING ON P.C.B
- Pb FREE PRODUCTS
- ROHS COMPLIANCE
- YELLOW SEGMENTS

Raw Material : GaAsP/GaP

**ABSOLUTE MAXIMUM RATING : ( Ta = 25°C )**

SYMBOL	PARAMETER	YELLOW	UNIT
PAD	Power Dissipation Per Bar	230	mW
VR	Reverse Voltage Per Bar	10	V
IAF	Continuous Forward Current Per Bar	40	mA
—	Derating Linear From 25°C Per Bar	0.27	mA/°C
Topr	Operating Temperature Range	-35°C to 85°C	
Tstg	Storage Temperature Range	-35°C to 85°C	

**ELECTRO-OPTICAL CHARACTERISTICS : ( Ta = 25°C )**

SYMBOL	PARAMETER	TEST CONDITION	MIN.	TYP.	MAX.	UNIT
VF	Forward Voltage , Per Bar	IF = 60mA		4.2	5.6	V
IR	Reverse Current , Per Bar	VR = 10V			100	µA
λP	Peak Emission Wavelength	IF = 20mA		583		nm
λD	Dominant Wavelength	IF = 20mA		585		nm
Δλ	Spectral Line Half—Width	IF = 20mA		30		nm
IV	Luminous Intensity Per Bar	IF = 30mA	4	10		mcd



20.0mm x 16.0mm SQUARE LIGHT BAR

B-1822Y

REV: A / 1

FORWARD CURRENT Vs. FORWARD VOLTAGE

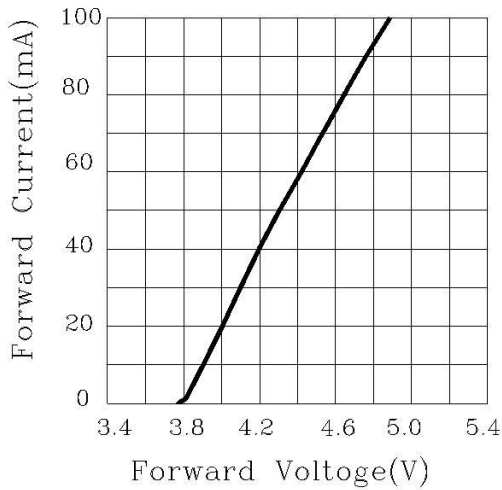

LUMINOUS INTENSITY Vs. FORWARD CURRENT

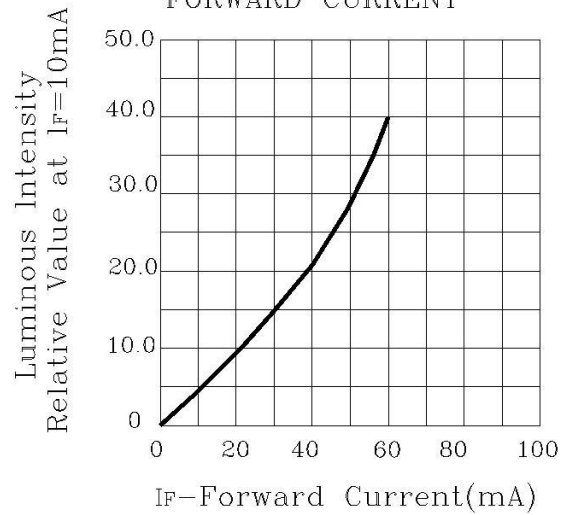

FORWARD CURRENT DERATING CURVE

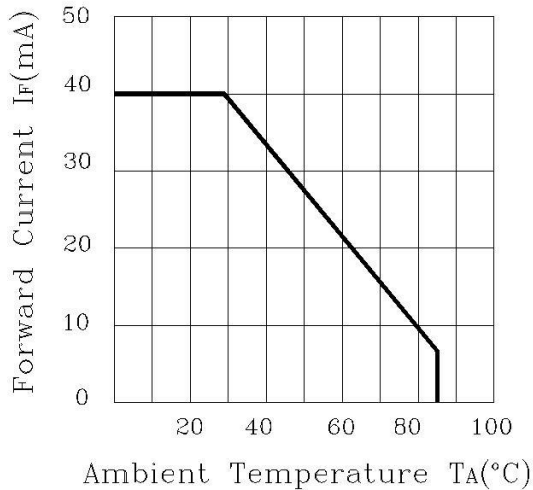

LUMINOUS INTENSITY Vs. AMBIENT TEMPERATURE

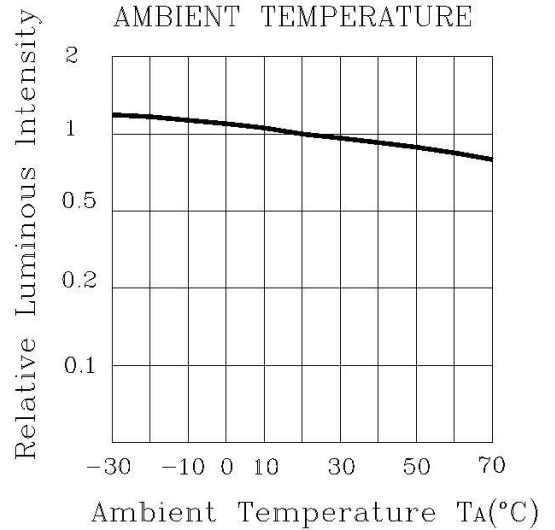



20.0mm x 16.0mm SQUARE LIGHT BAR

B-1822Y

REV: A / 1

**SOLDERING**

METHOD	SOLDERING CONDITIONS	REMARK
DIP SOLDERING	Bath temperature: 260 max Immersion time: within 5 sec	Solder no closer than 2mm from the base of the package Using soldering flux," RESIN FLUX" is recommended.
SOLDERING IRON	Soldering iron: 30W or smaller Temperature at tip of iron: 260 or lower Soldering time: within 5 sec.	During soldering, take care not to press the tip of iron against the PIN. (To prevent heat from being transferred directly to the PIN.)

1) When soldering the PIN of Display in a jig that the package is fixed with a panel (See fig.1), be careful not to stress the PIN with iron tip. When soldering Display in a condition that the package is fixed with a panel, be careful not to cling and stress the surface of Display on the panel to avoid damaging the Display.

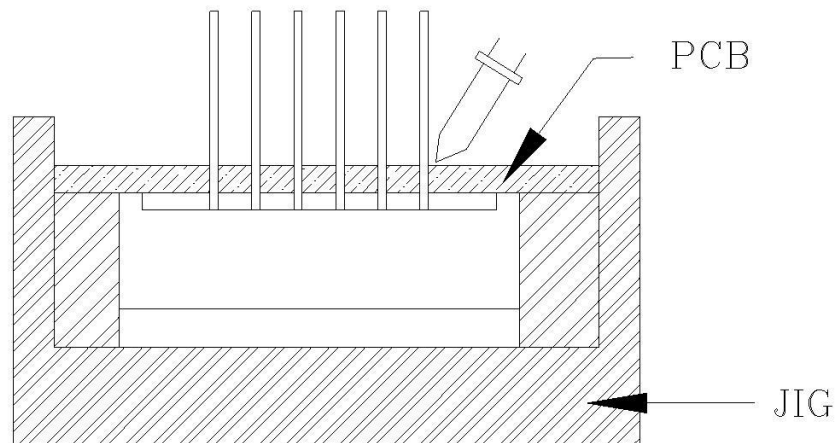

**Fig.1**

Regarding solution in the tinning oven for product-tinning, compound sub-solution made of tin & copper and silver is proposed with the temperature of Celsius 260. The proportion of the alloyed solution is tin 95.5: copper 3.5: silver 0.5 by percentage. The time of tinning is constantly 3 seconds.