

Features

- Low operating voltage: 3.3V
- Ultra low capacitance: 5pF (Max)
- Ultra low leakage: nA level
- Low clamping voltage
- Complies with following standards:
 - – IEC 61000-4-2 (ESD) immunity test
Air discharge: $\pm 30\text{kV}$
Contact discharge: $\pm 30\text{kV}$
 - – IEC61000-4- (Lightning) 40A (8/20 μs)
 - – IEC61000-4-4 (EFT) 40A (5/50ns)
- RoHS Compliant
- Lead Finish: NiPdAu

Mechanical Characteristics

- Package: DFN3020-10
- Lead Finish: Matte Tin
- Case Material: "Green" Molding Compound.
- Moisture Sensitivity: Level 3 per J-STD-020
- Terminal Connections: See Diagram Below
- Shipping Qty :3000/7Inch Tape & Reel

Applications

- Digital Visual Interface (DVI)
- Projection TV Monitors and Flat Panel Displays
- Notebook Computers
- Set Top Box
- Projection TV

Dimensions and Pin Configuration

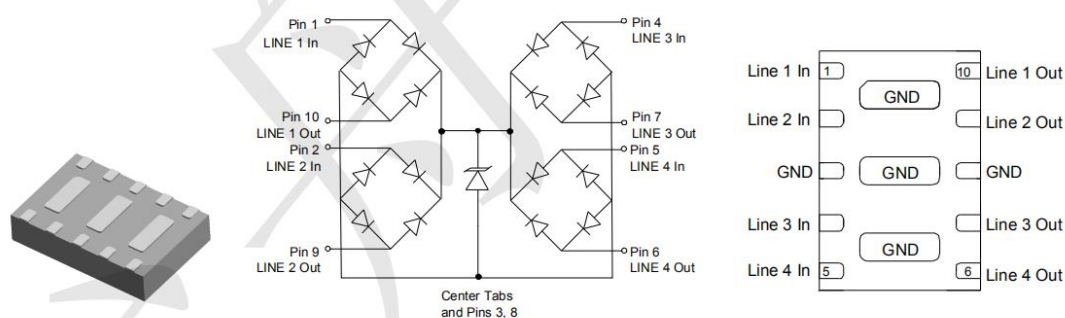

Marking:



xyyy=date code

Absolute Maximum Ratings (Tamb=25°C unless otherwise specified)

Parameter	Symbol	Value	Unit
Peak Pulse Power (8/20us)		1000	W
IEC61000-4-2(ESD)	Air Contact	± 30 ± 30	KV
Peak Pulse Current(8/20μs)	I _{PP}	40	A
Operating Temperature Range	T _J	-55 to +125	°C
Storage Temperature Range	T _{stg}	-55 to +150	°C

Electrical Characteristics (TA=25°C unless otherwise specified)

Parameter	Symbol	Conditions	Min.	Typ.	Max.	Units
Reverse Working Voltage	V _{RWM}				3.3	V
Punch-Through Voltage	V _{PT}	I _T =2μA	3.5			V
Snap-Back Voltage	V _{SB}	I _{SB} =50mA	2.8			V
Reverse Leakage Current	I _R	V _{RWM} =3.3V			0.5	μA
Clamping Voltage	V _C	I _{PP} =1A, t _p =8/20μs, Any I/O Pin to Ground			5.5	V
Clamping Voltage	V _C	I _{PP} =10A, t _p =8/20μs, Any I/O Pin to Ground			10.5	V
Clamping Voltage	V _C	I _{PP} =25A, t _p =8/20μs, Any I/O Pin to Ground			18	V
Clamping Voltage	V _C	I _{PP} =40A, t _p =8/20μs, Line to Line (Two I/O Pins Connected Together on Each Line)			25	V
Junction Capacitance	C _J	V _R =0V, f=1MHz, Between I/O Pins		1.7	2.5	pF
Junction Capacitance	C _J	V _R =0V, f=1MHz, Any I/O Pin to Ground		3.8	5	pF

Typical Performance Characteristics ($T_A=25^\circ\text{C}$ unless otherwise Specified)

Figure 1. Junction Capacitance vs. Reverse Voltage

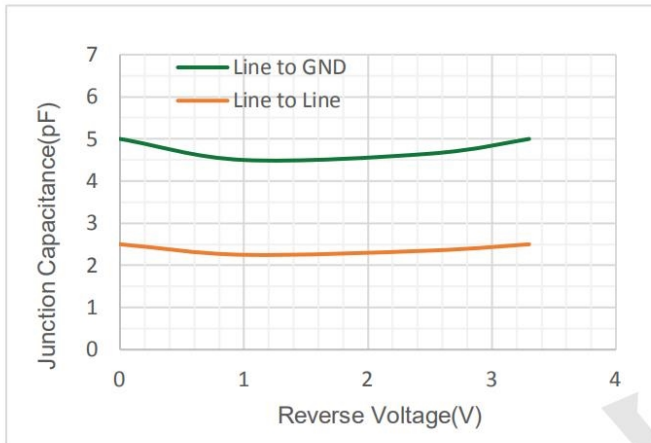

Figure 2. Peak Pulse Power vs. Pulse Time

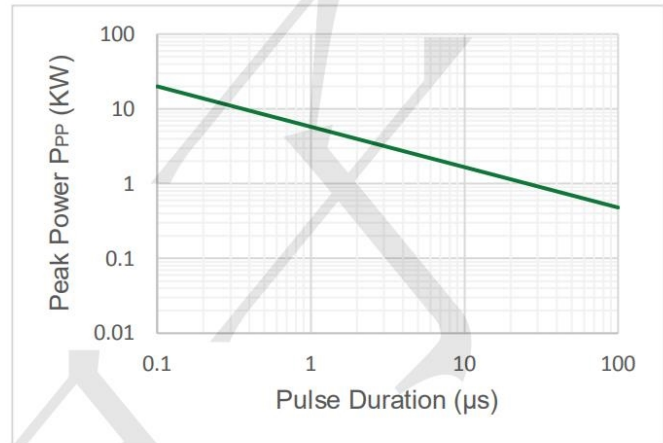

Figure 3. Clamping Voltage vs. Peak Pulse Current

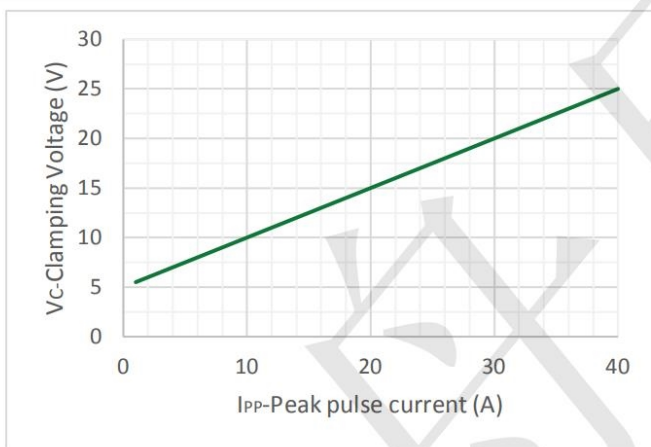

Figure 4. Power Derating Curve

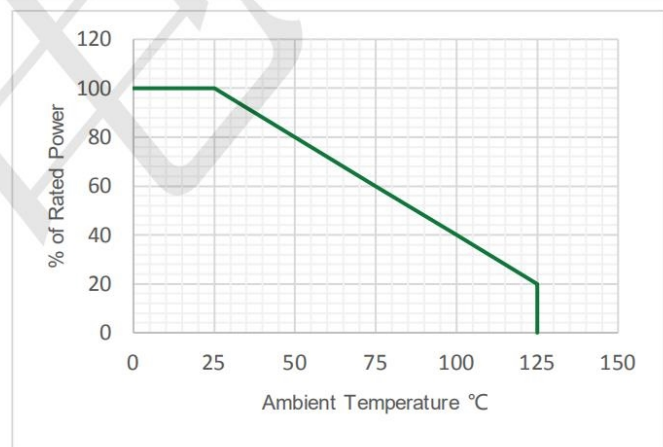
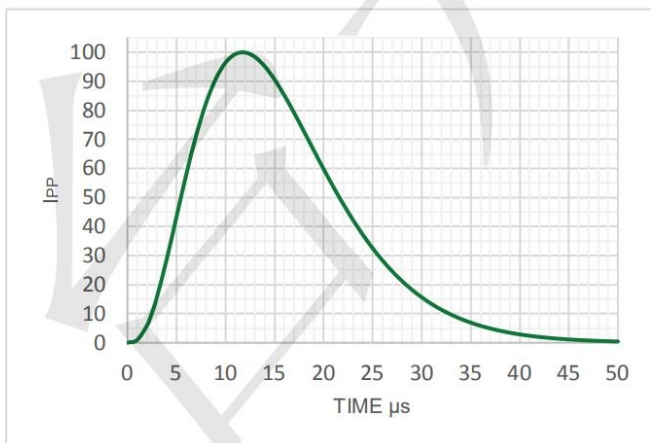
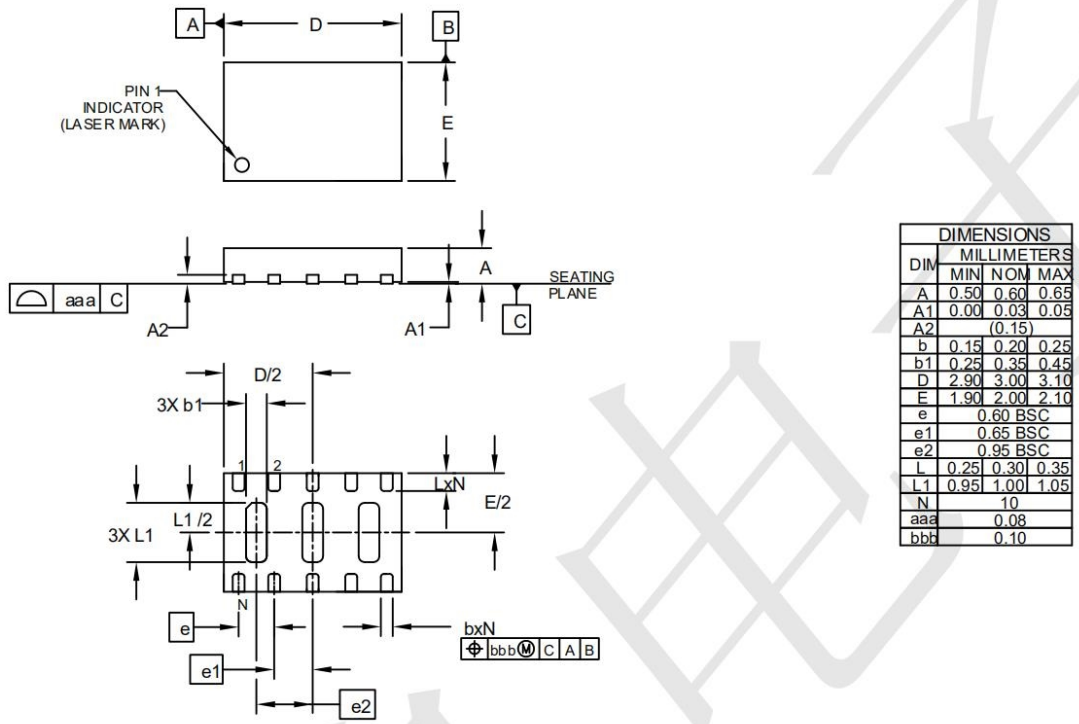

Figure 5. 8/20 μs Pulse Waveform



DFN3020-10 Package Outline Drawing



Suggested Land Pattern

