

## General Description

The LTC8701/8702/8703/8704 devices are single-, dual-, and quad- channel comparators with push-pull output that are ideal for power-sensitive, low-voltage applications. Featuring a nano-power (typical 310 nA), fast 12  $\mu$ s propagation delay, and a wide range of supply voltages from 1.7 V to 5.5 V with rail-to-rail common-mode voltage range makes the LTC8701/8702/8703/8704 an ideal choice for a wide variety of portable electronics applications, such as handsets, tablets, notebooks and portable devices that have extremely power constraints and tight board space.

The output of the LTC8701/8702/8703/8704 pulls to within 0.1 V of either supply rail without external pull-up circuitry, making these devices ideal for interface with both CMOS and TTL logics. All input and output pins can tolerate a continuous short-circuit fault condition to either rail. Internal hysteresis ensures clean output switching, even with slow-moving input signals.

The LTC8701/LTC8703 (single) is available in both SOT23-5L and SC70-5L packages. The LTC8702 (dual) is offered in SOIC-8L, MSOP-8L and DFN-8L packages. The quad-channel LTC8704 is offered in both SOIC-14L and TSSOP-14L packages. All devices are rated over  $-40^{\circ}\text{C}$  to  $+85^{\circ}\text{C}$  industrial temperature range.

## Features and Benefits

- Nanopower Operating Current (310 nA) Preserves Battery Power
- Propagation Delay: 12  $\mu$ s (100-mV Overdrive)
- Rail-to-Rail Input
- Push-Pull Output Current Drive: 30 mA Typically at 5V Supply
- Internal Hysteresis for Clean Switching
- Internal RF/EMI Filter
- Single 1.7 V to 5.5 V Supply Voltage Range
  - Can be Powered From the Same 1.8V/2.5V/3.3V/5V System Rails
- Operating Temperature Range:  $-40^{\circ}\text{C}$  to  $+85^{\circ}\text{C}$

## Applications

- Handsets, Tablets and Notebooks
- Wearables and Consumer Accessories
- Portable Medical Instruments
- Alarms and Monitoring Circuits
- Level Detectors
- IR Receivers
- Multi-vibrators

## Pin Configurations (Top View)

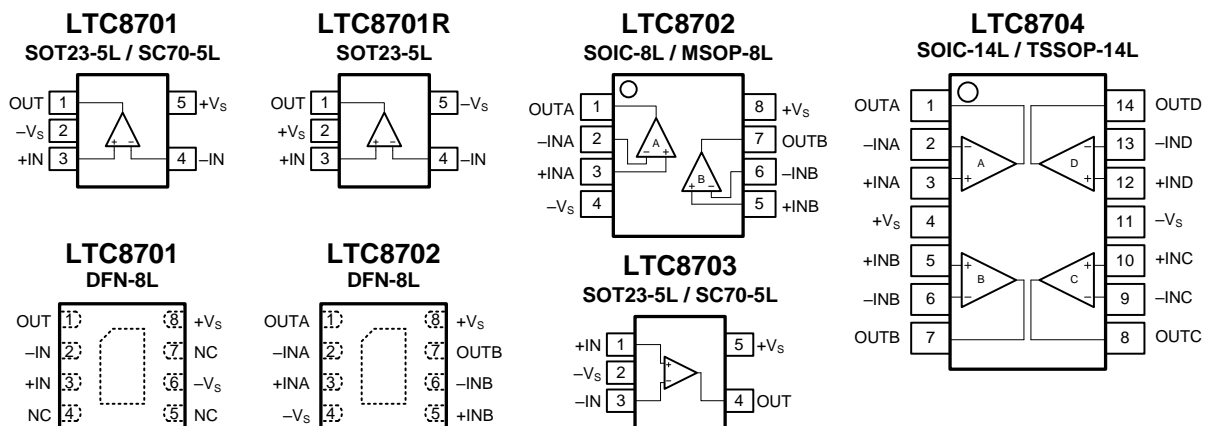

### Pin Description

Symbol	Description
-IN	Negative input. The voltage range is from ( $V_{S-} - 0.1V$ ) to ( $V_{S+} + 0.1V$ ).
+IN	Positive input. This pin has the same voltage range as -IN.
+V <sub>S</sub>	Positive power supply. The voltage is from 1.7V to 5.5V. Split supplies are possible as long as the voltage between V <sub>S+</sub> and V <sub>S-</sub> is from 1.7V to 5.5V.
-V <sub>S</sub>	Negative power supply. It is normally tied to ground. It can also be tied to a voltage other than ground as long as the voltage between V <sub>S+</sub> and V <sub>S-</sub> is from 1.7V to 5.5V.
OUT	Comparator output.

### Ordering Information

Orderable Type Number	Package Name	Package Quantity	Eco Class <sup>(1)</sup>	Operating Temperature	Marking Code
LTC8701YT5/R6	SOT23-5L	Tape and Reel, 3 000	Green (RoHS & no Sb/Br)	-40°C to +85°C	CL1
LTC8701YC5/R6	SC70-5L	Tape and Reel, 3 000	Green (RoHS & no Sb/Br)	-40°C to +85°C	CL1
LTC8701YF8/R6	DFN2x2-8L	Tape and Reel, 3 000	Green (RoHS & no Sb/Br)	-40°C to +85°C	CL1
LTC8701RYT5/R6	SOT23-5L	Tape and Reel, 3 000	Green (RoHS & no Sb/Br)	-40°C to +85°C	CL9
LTC8702YS8/R8	SOIC-8L	Tape and Reel, 4 000	Green (RoHS & no Sb/Br)	-40°C to +85°C	CL2 Y
LTC8702YV8/R6	MSOP-8L	Tape and Reel, 3 000	Green (RoHS & no Sb/Br)	-40°C to +85°C	CL2Y
LTC8702YF8/R6	DFN2x2-8L	Tape and Reel, 3 000	Green (RoHS & no Sb/Br)	-40°C to +85°C	CL2
LTC8703YT5/R6	SOT23-5L	Tape and Reel, 3 000	Green (RoHS & no Sb/Br)	-40°C to +85°C	CL3
LTC8703YC5/R6	SC70-5L	Tape and Reel, 3 000	Green (RoHS & no Sb/Br)	-40°C to +85°C	CL3
LTC8704YS14/R5	SOIC-14L	Tape and Reel, 2 500	Green (RoHS & no Sb/Br)	-40°C to +85°C	CL4 Y
LTC8704YT14/R6	TSSOP-14L	Tape and Reel, 3 000	Green (RoHS & no Sb/Br)	-40°C to +85°C	CL4 Y

(1) *Eco Class - The planned eco-friendly classification: Pb-Free (RoHS) or Green (RoHS & Halogen Free).*

(2) *Please contact to your Linearin representative for the latest availability information and product content details.*

## Limiting Value

*In accordance with the Absolute Maximum Rating System (IEC 60134).*

Parameter	Absolute Maximum Rating
Supply Voltage, $V_{S+}$ to $V_{S-}$	10.0 V
Signal Input Terminals: Voltage, Current	$V_{S-} - 0.3$ V to $V_{S+} + 0.3$ V, $\pm 10$ mA
Output Short-Circuit	Continuous
Storage Temperature Range, $T_{stg}$	$-65$ °C to $+150$ °C
Junction Temperature, $T_J$	150 °C
Lead Temperature Range (Soldering 10 sec)	260 °C

## ESD Rating

Parameter	Item	Value	Unit
Electrostatic Discharge Voltage	Human body model (HBM), per MIL-STD-883J / Method 3015.9	$\pm 5\ 000$	V
	Charged device model (CDM), per ESDA/JEDEC JS-002-2014	$\pm 2\ 000$	
	Machine model (MM), per JESD22-A115C	$\pm 250$	

(1) JEDEC document JEP155 states that 500-V HBM allows safe manufacturing with a standard ESD control process.

(2) JEDEC document JEP157 states that 250-V CDM allows safe manufacturing with a standard ESD control process.

### Electrical Characteristics

$V_S = 5.0V$ ,  $T_A = +25^\circ C$ , unless otherwise noted.

**Boldface limits apply over the specified temperature range,  $T_A = -40$  to  $+85^\circ C$ .**

Symbol	Parameter	Conditions	Min.	Typ.	Max.	Unit
<b>OFFSET VOLTAGE</b>						
$V_{OS}$	Input offset voltage	$V_{CM} = 0$		$\pm 0.5$	$\pm 3.5$	mV
		$T_A = -40$ to $+85^\circ C$			<b><math>\pm 4.0</math></b>	
$V_{OS\ TC}$	Offset voltage drift	$T_A = -40$ to $+85^\circ C$		$\pm 1$		$\mu V/^\circ C$
PSRR	Power supply rejection ratio	$V_S = 1.7$ to $5.5V$ , $V_{CM} < (V_{S+} - 1V)$	65	85		dB
		$T_A = -40$ to $+85^\circ C$	<b>60</b>			
$V_{HYST}$	Input hysteresis	$V_{CM} = 0$		5		mV
<b>INPUT BIAS CURRENT</b>						
$I_B$	Input bias current	$V_{CM} = V_S / 2$		5		pA
		$T_A = +85^\circ C$		150		
$I_{OS}$	Input offset current	$V_{CM} = V_S / 2$		10		pA
<b>INPUT VOLTAGE RANGE</b>						
$V_{CM}$	Common-mode voltage range		$V_{S-} - 0.1$		$V_{S+} + 0.1$	V
CMRR	Common-mode rejection ratio	$V_{CM} = -0.1$ to $5.1V$	62	84		dB
		$V_{CM} = 0$ to $4.8V$ , $T_A = -40$ to $+85^\circ C$	<b>56</b>			
		$V_S = 1.8V$ , $V_{CM} = -0.1$ to $1.9V$	60	82		
		$V_{CM} = 0$ to $1.6V$ , $T_A = -40$ to $+85^\circ C$	<b>55</b>			
<b>INPUT IMPEDANCE</b>						
$R_{IN}$	Input resistance		100			G $\Omega$
$C_{IN}$	Input capacitance	Differential		2.0		pF
		Common mode		3.5		
<b>OUTPUT</b>						
$V_{OH}$	High output voltage swing	$I_{SOURCE} = 1mA$	$V_{S+} - 90$	$V_{S+} - 73$		mV
		$T_A = -40$ to $+85^\circ C$	$V_{S+} - 120$			
$V_{OL}$	Low output voltage swing	$I_{SINK} = 1mA$		$V_{S-} + 48$	$V_{S-} + 60$	mV
		$T_A = -40$ to $+85^\circ C$			$V_{S-} + 80$	
$I_{SC}$	Output short-circuit current	Source current, OUT to $V_S / 2$	30	36		mA
		Sink current, OUT to $V_S / 2$		-27	-22	
<b>POWER SUPPLY</b>						
$V_S$	Operating supply voltage	$T_A = -40$ to $+85^\circ C$	1.7		5.5	V
$I_q$	Quiescent current (per comparator)	$V_S = 1.8V$ , $V_{CM} = 0.3V$		310		nA
		$V_S = 1.8V$ , $V_{CM} = 1.5V$		380		
		$V_S = 5.0V$ , $V_{CM} = 0.3V$		355		
		$V_S = 5.0V$ , $V_{CM} = 4.7V$		440	670	

### Electrical Characteristics (continued)

$V_S = 5.0V$ ,  $T_A = +25^\circ C$ , unless otherwise noted.

**Boldface limits apply over the specified temperature range,  $T_A = -40$  to  $+85^\circ C$ .**

Symbol	Parameter	Conditions	Min.	Typ.	Max.	Unit
<b>SWITCHING CHARACTERISTICS</b>						
$t_{PD+}$	Propagation delay time, Low to high	Input overdrive = 10 mV, $C_I = 15$ pF		16		$\mu s$
		Input overdrive = 100 mV, $C_I = 15$ pF		12		
$t_{PD-}$	Propagation delay time, High to low	Input overdrive = 10 mV, $C_I = 15$ pF		17		$\mu s$
		Input overdrive = 100 mV, $C_I = 15$ pF		13		
$t_R$	Rise time	Input overdrive = 10 mV, $C_I = 15$ pF		230		ns
		Input overdrive = 100 mV, $C_I = 15$ pF		190		
$t_F$	Fall time	Input overdrive = 10 mV, $C_I = 15$ pF		300		ns
		Input overdrive = 100 mV, $C_I = 15$ pF		220		
<b>THERMAL CHARACTERISTICS</b>						
$T_A$	Operating temperature range		-40		+85	$^\circ C$
$\theta_{JA}$	Package Thermal Resistance	SC70-5L		333		$^\circ C/W$
		SOT23-5L		190		
		DFN2x2-8L		80		
		MSOP-8L		216		
		SOIC-8L		125		
		TSSOP-14		112		
		SOIC-14L		115		

## Typical Performance Characteristics

At  $T_A = +25^\circ\text{C}$ ,  $V_S = 5.0\text{V}$ ,  $V_{CM} = V_S/2$ ,  $R_L = 10\text{k}\Omega$ , and  $C_L = 15\text{pF}$ , unless otherwise noted.

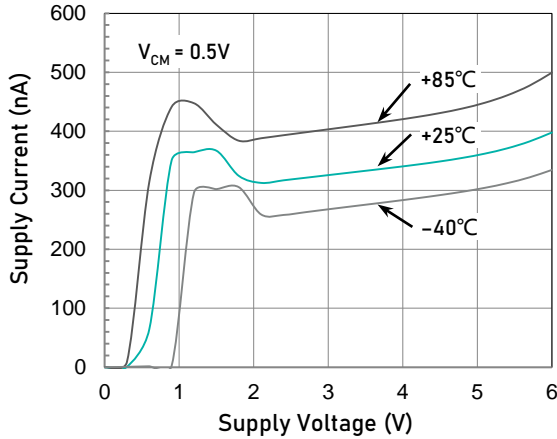

Supply Current vs. Supply Voltage

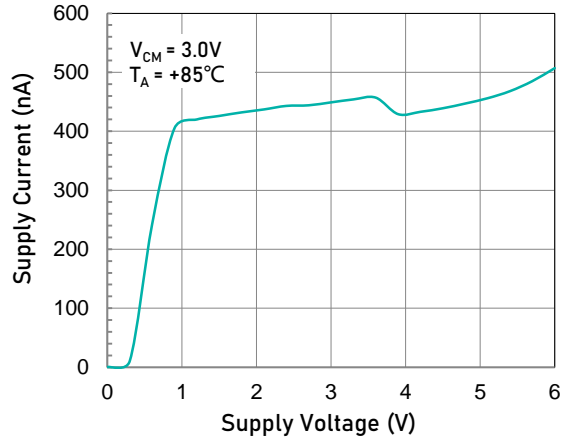

Supply Current vs. Supply Voltage

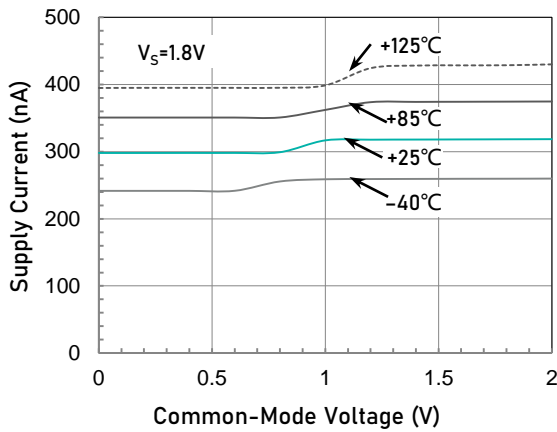

Supply Current vs. Common-Mode Input ( $V_S = 1.8\text{V}$ )

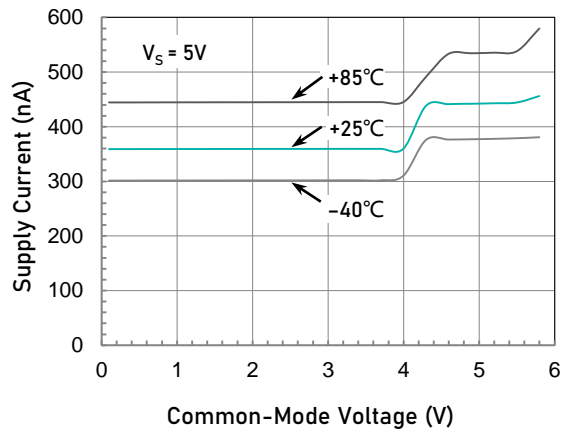

Supply Current vs. Common-Mode Input ( $V_S = 5.0\text{V}$ )

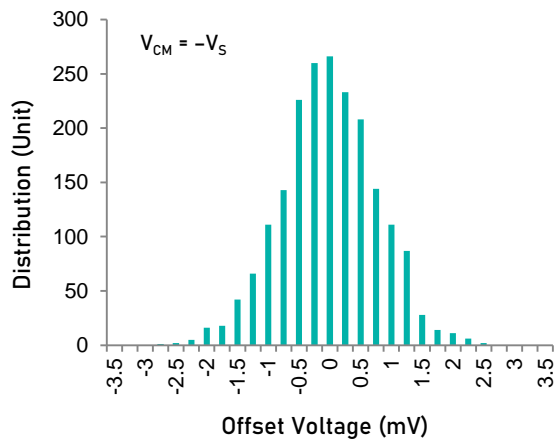

Offset Voltage Production Distribution

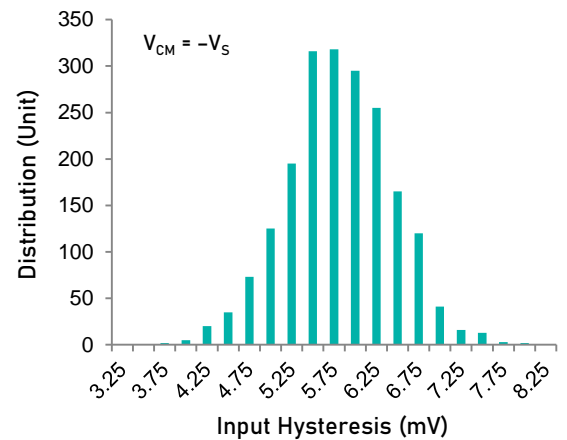

Hysteresis Production Distribution

CAUTION: These devices are sensitive to electrostatic discharge; follow proper IC Handling Procedures.  
 Linearin and designs are registered trademarks of Linearin Technology Corporation.  
 © Copyright Linearin Technology Corporation. All Rights Reserved.  
 All other trademarks mentioned are the property of their respective owners.

## Typical Performance Characteristics

At  $T_A = +25^\circ\text{C}$ ,  $V_S = 5.0\text{V}$ ,  $V_{CM} = V_S/2$ ,  $R_L = 10\text{k}\Omega$ , and  $C_L = 15\text{pF}$ , unless otherwise noted.

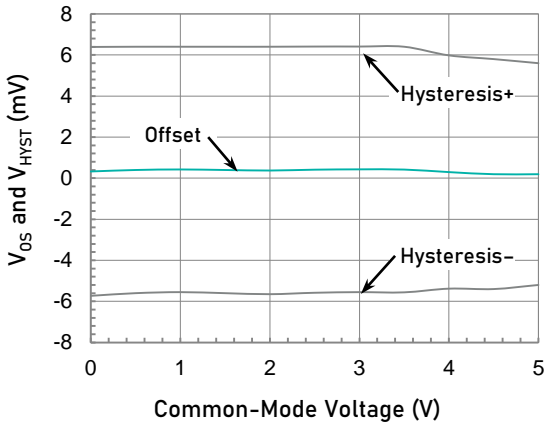

$V_{OS}$  and  $V_{HYST}$  vs. Common-Mode Input

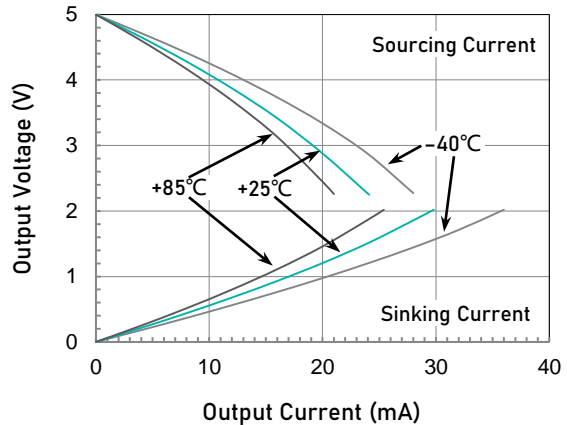

Output Voltage vs. Output Current

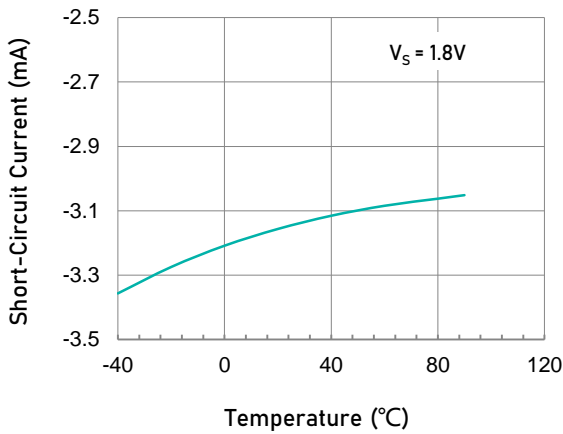

Short-Circuit Current vs. Temperature ( $V_S = 1.8\text{V}$ )

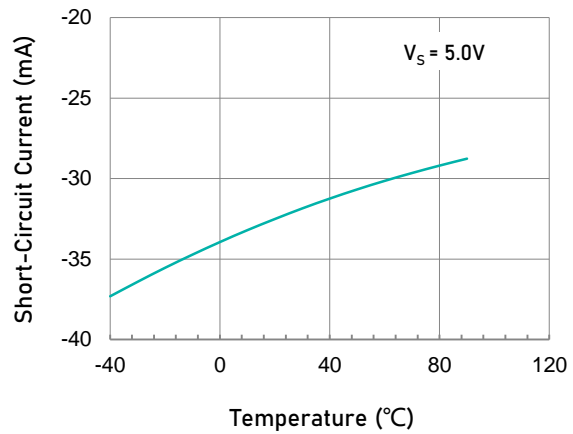

Short-Circuit Current vs. Temperature ( $V_S = 5.0\text{V}$ )

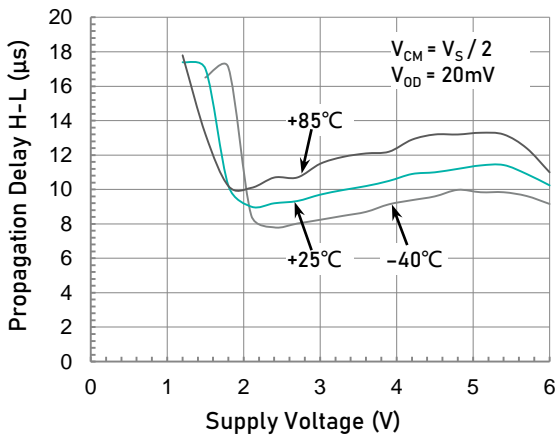

Propagation Delay H-L ( $t_{PD-}$ ) vs. Supply Voltage

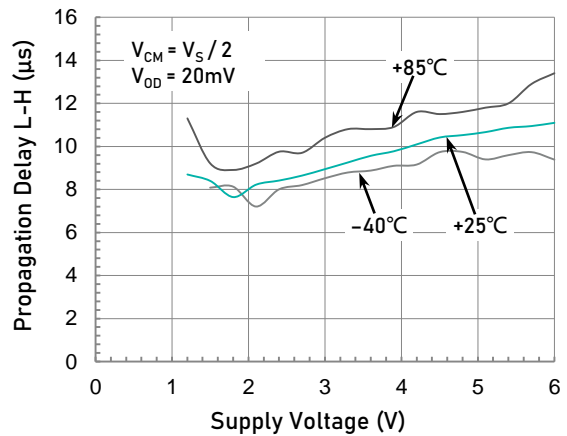

Propagation Delay L-H ( $t_{PD+}$ ) vs. Supply Voltage

CAUTION: These devices are sensitive to electrostatic discharge; follow proper IC Handling Procedures.  
 Linearin and designs are registered trademarks of Linearin Technology Corporation.  
 © Copyright Linearin Technology Corporation. All Rights Reserved.  
 All other trademarks mentioned are the property of their respective owners.

## Typical Performance Characteristics

At  $T_A = +25^\circ\text{C}$ ,  $V_S = 5.0\text{V}$ ,  $V_{CM} = V_S/2$ ,  $R_L = 10\text{k}\Omega$ , and  $C_L = 15\text{pF}$ , unless otherwise noted.

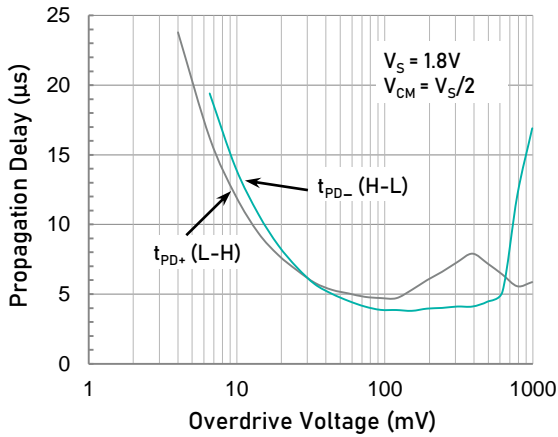

Propagation Delay vs. Input Overdrive ( $V_S = 1.8\text{V}$ )

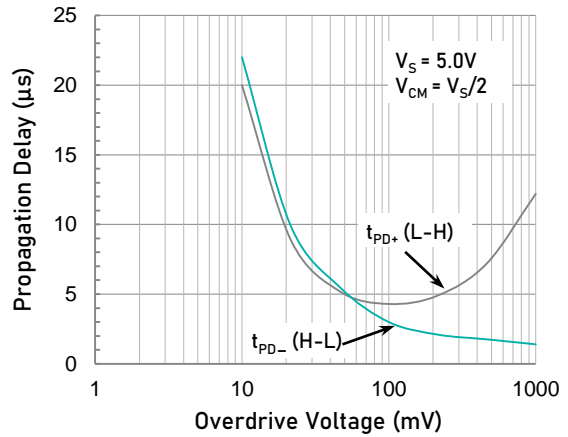

Propagation Delay vs. Input Overdrive ( $V_S = 5.0\text{V}$ )

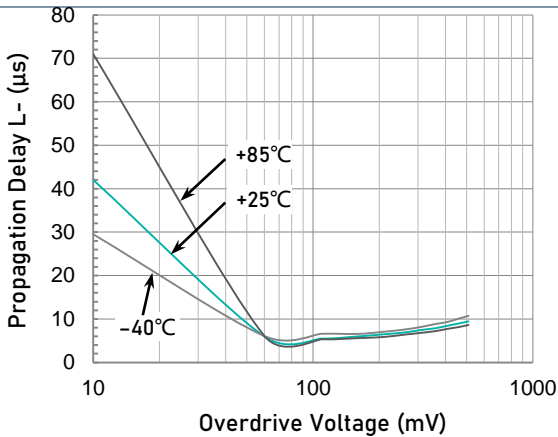

Propagation Delay H-L ( $t_{PD-}$ ) vs. Input Overdrive

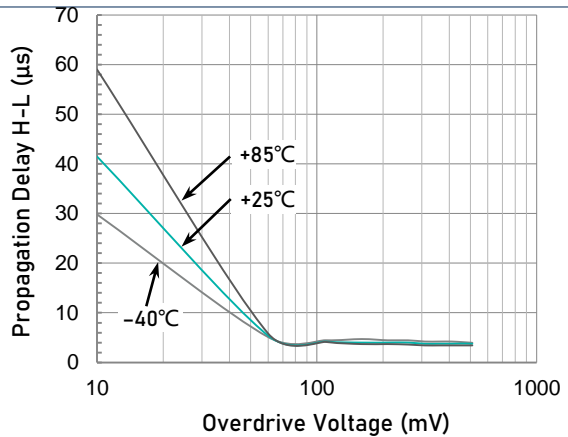

Propagation Delay L-H ( $t_{PD+}$ ) vs. Input Overdrive

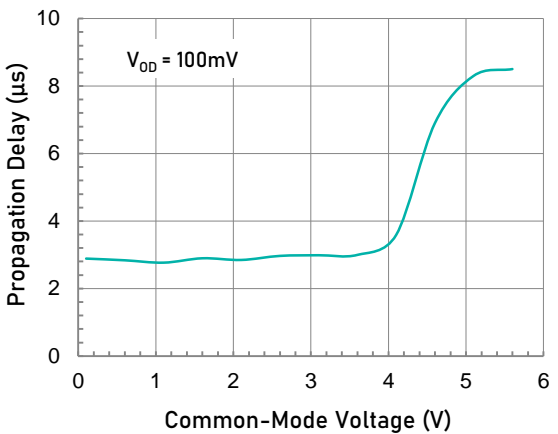

Propagation Delay H-L ( $t_{PD-}$ ) vs. Input Common-Mode Voltage

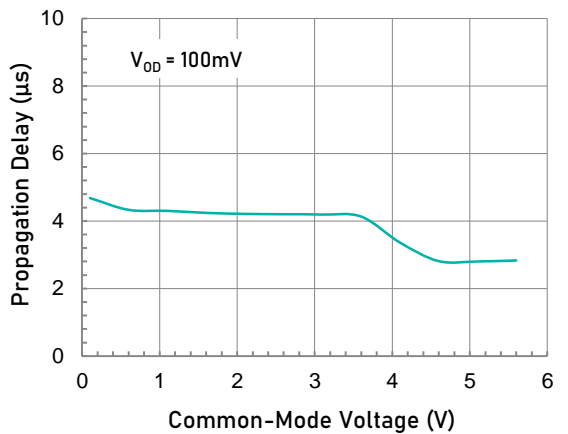

Propagation Delay L-H ( $t_{PD+}$ ) vs. Input Common-Mode Voltage

CAUTION: These devices are sensitive to electrostatic discharge; follow proper IC Handling Procedures.  
 Linearin and designs are registered trademarks of Linearin Technology Corporation.  
 © Copyright Linearin Technology Corporation. All Rights Reserved.  
 All other trademarks mentioned are the property of their respective owners.



### Typical Performance Characteristics

At  $T_A = +25^\circ\text{C}$ ,  $V_S = 5.0\text{V}$ ,  $V_{CM} = V_S/2$ ,  $R_L = 10\text{k}\Omega$ , and  $C_L = 15\text{pF}$ , unless otherwise noted.

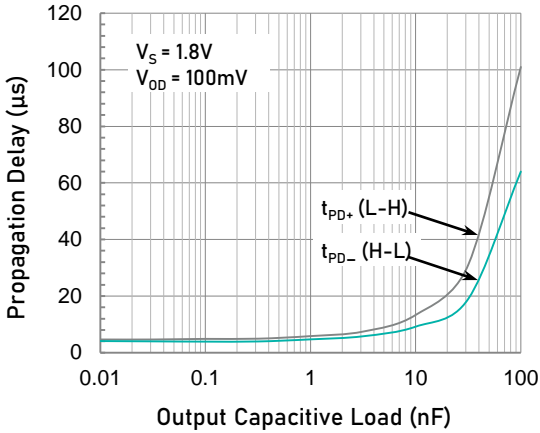

Propagation Delay vs. Capacitive Load ( $V_S = 1.8\text{V}$ )

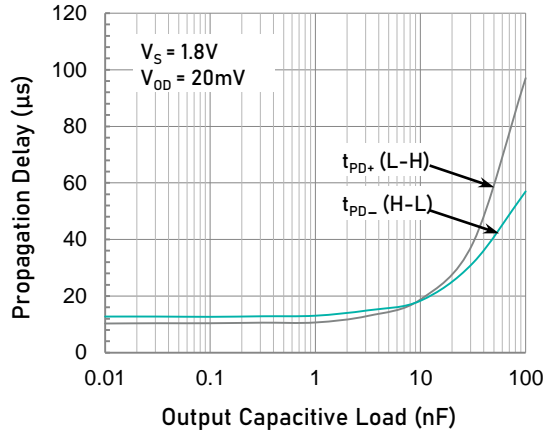

Propagation Delay vs. Capacitive Load ( $V_S = 1.8\text{V}$ )

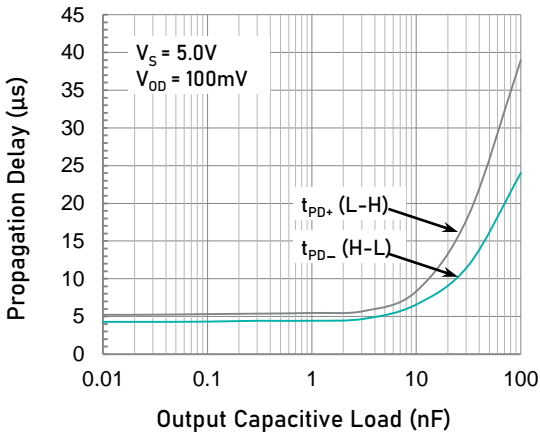

Propagation Delay vs. Capacitive Load ( $V_S = 5.0\text{V}$ )

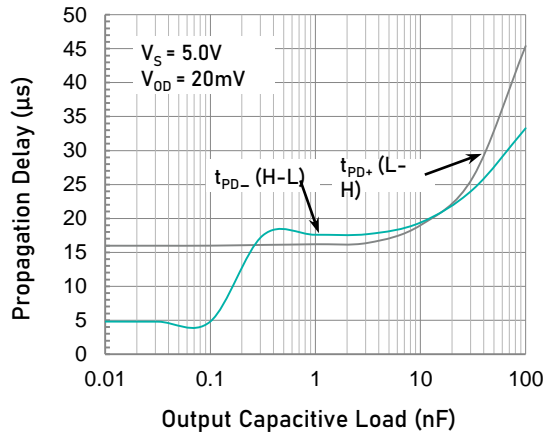

Propagation Delay vs. Capacitive Load ( $V_S = 5.0\text{V}$ )

## Application Notes

## OPERATING VOLTAGE

The LTC8701/8702/8703/8704 family of nano-power comparators is fully specified and ensured for operation from 1.7V to 5.5V ( $\pm 0.85V$  to  $\pm 2.75V$ ). In addition, and many specifications apply over the industrial temperature range of  $-40^{\circ}C$  to  $+85^{\circ}C$ . Parameters that vary significantly with operating voltages or temperature are illustrated in the Typical Characteristics graphs.

NOTE: Supply voltages ( $V_{S+}$  to  $V_{S-}$ ) higher than +10V can permanently damage the device.

## INPUT VOLTAGE

The input common-mode voltage range of the LTC8701/8702/8703/8704 comparators extends 100-mV beyond the supply rails. This performance is achieved with a complementary input stage: an N-channel input differential pair in parallel with a P-channel differential pair. The N-channel pair is active for input voltages close to the positive rail, typically  $V_{S+}-1.4V$  to the positive supply, whereas the P-channel pair is active for inputs from 100mV below the negative supply to approximately  $V_{S+}-1.4V$ . There is a small transition region, typically  $V_{S+}-1.2V$  to  $V_{S+}-1V$ , in which both pairs are on. This 200mV transition region can vary up to 200mV with process variation. Thus, the transition region (both stages on) can range from  $V_{S+}-1.4V$  to  $V_{S+}-1.2V$  on the low end, up to  $V_{S+}-1V$  to  $V_{S+}-0.8V$  on the high end. Within this transition region, PSRR, CMRR, offset voltage, offset drift, and THD can be degraded compared to device operation outside this region.

## INPUT VOLTAGE

The LTC8701/8702/8703/8704 comparator family uses CMOS transistors at the inputs which prevent phase inversion when the input pins exceed the supply voltages.

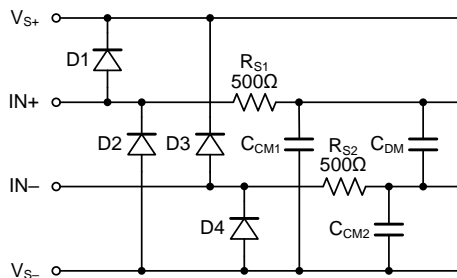

Figure 1. Input EMI Filter and Clamp Circuit

Figure 1 shows the input EMI filter and clamp circuit. The LTC8701/8702/8703/8704 comparators have internal ESD protection diodes (D1, D2, D3, and D4) that are connected between the inputs and each supply rail. These diodes protect the input transistors

in the event of electrostatic discharge and are reverse biased during normal operation. This protection scheme allows voltages as high as approximately 300mV beyond the rails to be applied at the input of either terminal without causing permanent damage. See the table of Absolute Maximum Ratings for more information.

## EMI REJECTION RATIO

Circuit performance is often adversely affected by high frequency EMI. When the signal strength is low and transmission lines are long, an amplifier must accurately amplify the input signals. However, all comparator pins — the non-inverting input, inverting input, positive supply, negative supply, and output pins — are susceptible to EMI signals. These high frequency signals are coupled into a comparator by various means, such as conduction, near field radiation, or far field radiation. For example, wires and printed circuit board (PCB) traces can act as antennas and pick up high frequency EMI signals.

Amplifiers do not amplify EMI or RF signals due to their relatively low bandwidth. However, due to the nonlinearities of the input devices, comparators can rectify these out of band signals. When these high frequency signals are rectified, they appear as a dc offset at the output.

The LTC8701/8702/8703/8704 comparators have integrated EMI filters at their input stage. A mathematical method of measuring EMIRR is defined as follows:

$$EMIRR = 20 \log (V_{IN\_PEAK} / \Delta V_{OS})$$

## INTERNAL HYSTERESIS

Most high-speed comparators oscillate in the linear region because of noise or undesired parasitic feedback. This tends to occur when the voltage on one input is at or equal to the voltage on the other input. To counter the parasitic effects and noise, the devices have an internal hysteresis of 5 mV.

The hysteresis in a comparator creates two trip points: one for the rising input voltage and one for the falling input voltage. The difference between the trip points is the hysteresis. The average of the trip points is the offset voltage. When the comparator's input voltages are equal, the hysteresis effectively causes one comparator input voltage to move quickly past the other, thus taking the input out of the region where oscillation occurs. Standard comparators require hysteresis to be added with external resistors. To increase hysteresis and noise margin even more, add positive feedback with two resistors as a voltage divider from the output to the non-inverting input. Figure 2 illustrates the case where

### Application Notes

$V_{IN+}$  is varied. If the inputs were reversed, the figure would look the same, except the output would be inverted.

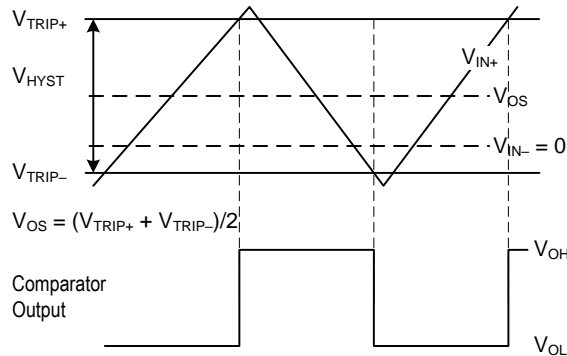

Figure 2. Input and Output Waveform, Non-inverting Input Varied

#### MAXIMIZING PERFORMANCE THROUGH PROPER LAYOUT

To achieve the maximum performance of the extremely high input impedance and low offset voltage of the LTC8701/8702/8703/8704 devices, care is needed in laying out the circuit board. The PCB surface must remain clean and free of moisture to avoid leakage currents between adjacent traces. Surface coating of the circuit board reduces surface moisture and provides a humidity barrier, reducing parasitic resistance on the board. The use of guard rings around the comparator inputs further reduces leakage currents. Figure 3 shows proper guard ring configuration and the top view of a surface-mount layout. The guard ring does not need to be a specific width, but it should form a continuous loop around both inputs. By setting the guard ring voltage equal to the voltage at the non-inverting input, parasitic capacitance is minimized as well. For further reduction of leakage currents, components can be mounted to the PCB using Teflon standoff insulators.

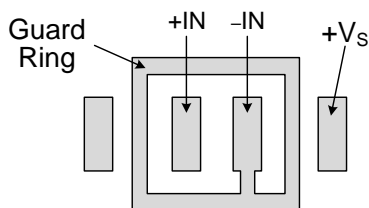

Figure 3. Use a guard ring around sensitive pins

Other potential sources of offset error are thermoelectric voltages on the circuit board. This voltage, also called Seebeck voltage, occurs at the junction of two dissimilar metals and is proportional

to the temperature of the junction. The most common metallic junctions on a circuit board are solder-to-board trace and solder-to-component lead. If the temperature of the PCB at one end of the component is different from the temperature at the other end, the resulting Seebeck voltages are not equal, resulting in a thermal voltage error.

This thermocouple error can be reduced by using dummy components to match the thermoelectric error source. Placing the dummy component as close as possible to its partner ensures both Seebeck voltages are equal, thus canceling the thermocouple error. Maintaining a constant ambient temperature on the circuit board further reduces this error. The use of a ground plane helps distribute heat throughout the board and reduces EMI noise pickup.

#### INPUT-TO-OUTPUT COUPLING

To minimize capacitive coupling, the input and output signal traces should not be parallel. This helps reduce unwanted positive feedback.

## Typical Application Circuits

### IR RECEIVER AFE AND WAKE-UP CIRCUIT

Infrared (IR) communication is inherently immune to RF interference as long as there is a line-of-sight path between the transmitter and the receiver. It is also one of the lowest cost communication schemes. This makes it a good choice for implementing wireless communications in applications such as utility metering. These smart utility meters are hermetically sealed and use a combination of batteries and solar cells to power the system. Maintenance in the field can be costly, so minimizing system power consumption to extend battery life is desired.

A common system topology to extend battery life is to use a power efficient IR receiver analog front end (AFE) that is always on and wakes up the host only when there is a valid IR signal detected as shown in Figure 1. Power efficient comparators such as the LTC870x can be used in the IR receiver AFE to increase battery life.

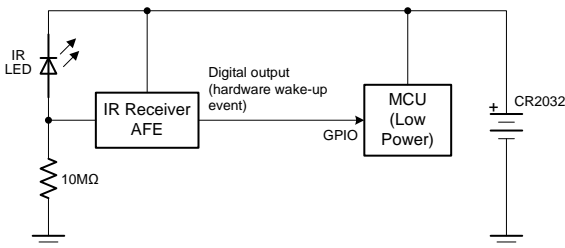

Figure 4. Coin Cell Battery Powered IR Receiver

The LTC870x device is responsible for two major tasks:

1. IR signal conditioning,
2. Host system wake-up.

The benefits of LTC870x for this application include the following:

1. Nano quiescent supply current (310 nA),
2. Low input bias current (5 pA) which allows a greater load resistor value.

The LTC870x device is constantly powered to always be ready to receive IR signals and wake up the host microcontroller (MCU) when data is received. The short working distance (approx 5 cm) is suitable for a virtual-contact operation where the IR transmitter and receiver are closely placed with an optional mechanical alignment guide.

Figure 1 shows the IR receiver system block diagram. The host MCU is normally in the shutdown mode (during which the quiescent current is less than 1  $\mu$ A) except when data is being transferred.

Figure 2 shows the detailed circuit design. The circuit establishes a threshold through  $R_2$  and  $C_1$  which automatically adapts to the ambient light level. To

further reduce BOM cost, this example uses an IR LED as the IR receiver. The IR LED is reverse-biased to function as a photodiode (but at a reduced sensitivity).

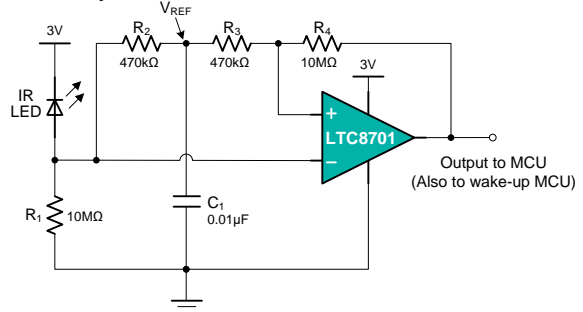

Figure 5. IR Receiver AFE Using LTC8701 (Push-Pull Output)

The low input bias current allows a greater load resistor value ( $R_1$ ) without sacrificing linearity, which in turn helps reduce the always-on supply current.

The load resistor  $R_1$  converts the IR light induced current into a voltage fed into the inverting input of the comparator.  $R_2$  and  $C_1$  establish a reference voltage  $V_{REF}$  which tracks the mean amplitude of the IR signal. The non-inverting input is connected to  $V_{REF}$  through  $R_3$ . And finally  $R_3$  and  $R_4$  are used to introduce additional hysteresis to keep the output free of spurious toggles.

To achieve years of operation running on a single coin cell battery, the host MCU must be put in the shutdown power state. The MCU wakes up when data is received. After the data transmission is complete, the MCU reverts to the shutdown state and the overall supply current drops back to the micro amps level.

PARAMETER	
Aggregated always-on Current	2 $\mu$ A
Peak Current (Wireless Radio + IR LED)	30 mA
Active Duration /Frequency	30 sec/30 days
CR 2032 Coin Cell Battery Capacity	240 mAh
CR 2032 Lifespan (minimum)	5 years
Lead Temperature Range (Soldering 10 sec)	260 $^{\circ}$ C

## Typical Application Circuits

---

Table 1 shows a power budget based on the following assumptions:

1. The aggregated always-on quiescent current is estimated as 2  $\mu\text{A}$ , which includes the LTC8701 quiescent current, divider network current, and the MCU and supporting devices current in the shutdown state.
2. Peak current during active data transmission and RF radio operation is estimated as 30 mA.
3. Each active session last for 30 seconds or less for every 30 days or longer.
4. The coin cell is based on an Energizer CR2032, which is specified at 240 mAh and includes a 1% annual self-discharge rate.

## Tape and Reel Information

### REEL DIMENSIONS

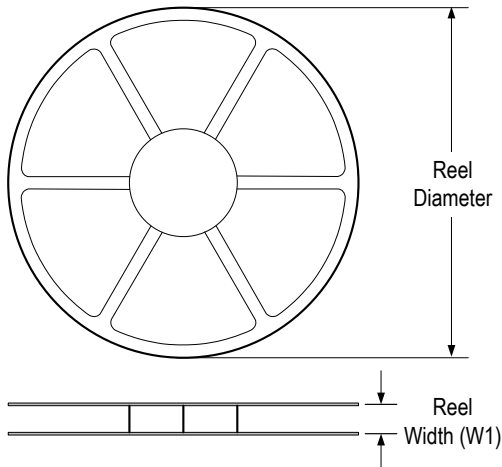

### TAPE DIMENSIONS

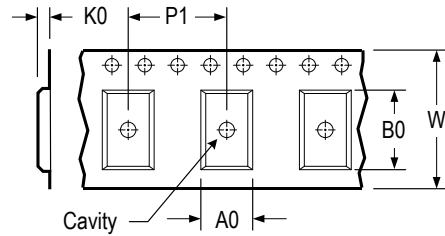

A0	Dimension designed to accommodate the component width
B0	Dimension designed to accommodate the component length
K0	Dimension designed to accommodate the component thickness
W	Overall width of the carrier tape
P1	Pitch between successive cavity centers

### QUADRANT ASSIGNMENTS FOR PIN 1 ORIENTATION IN TAPE

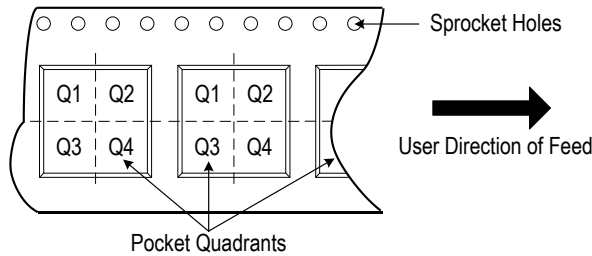

\* All dimensions are nominal

Device	Package Type	Pins	SPQ	Reel Diameter (mm)	Reel Width W1 (mm)	A0 (mm)	B0 (mm)	K0 (mm)	P1 (mm)	W (mm)	Pin 1 Quadrant
LTC8701YT5/R6	SOT23	5	3 000	178	9.0	3.3	3.2	1.5	4.0	8.0	Q3

## Package Outlines

### DIMENSIONS, SOT23-5L

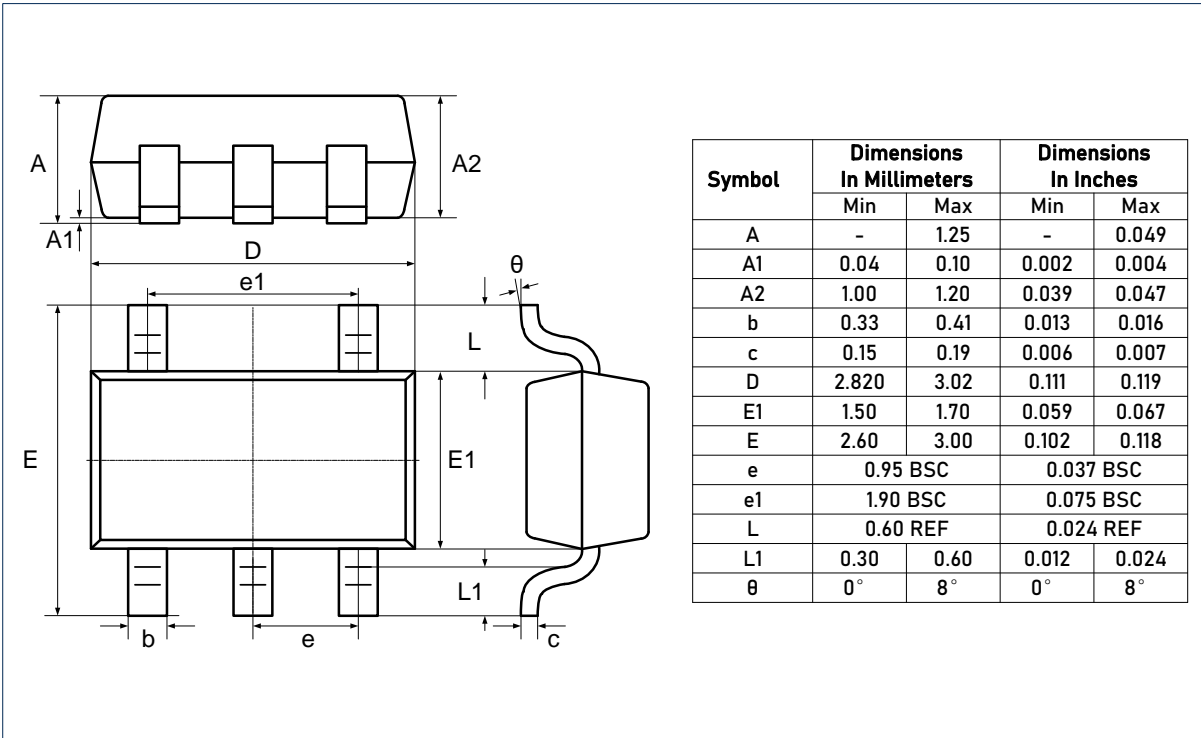

### RECOMMENDED SOLDERING FOOTPRINT, SOT23-5L

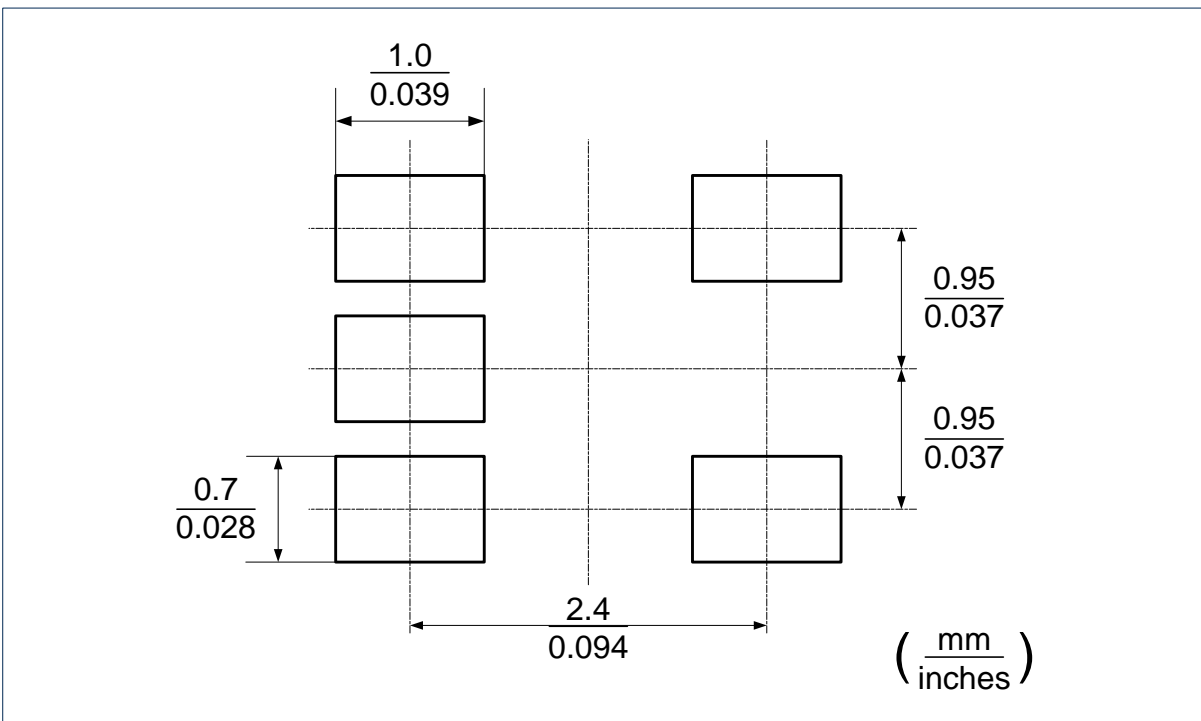

CAUTION: These devices are sensitive to electrostatic discharge; follow proper IC Handling Procedures.  
 Linearin and designs are registered trademarks of Linearin Technology Corporation.  
 © Copyright Linearin Technology Corporation. All Rights Reserved.  
 All other trademarks mentioned are the property of their respective owners.

## Package Outlines (continued)

### DIMENSIONS, SC70-5L (SOT353)

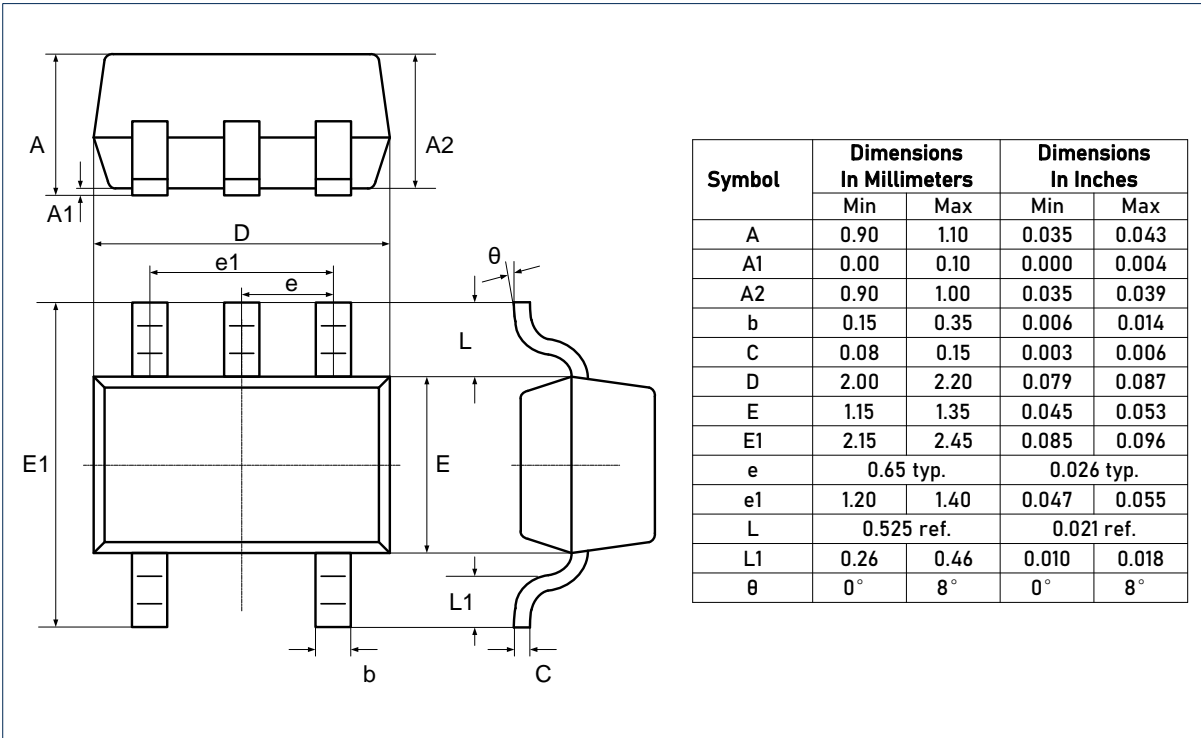

### RECOMMENDED SOLDERING FOOTPRINT, SC70-5L (SOT353)

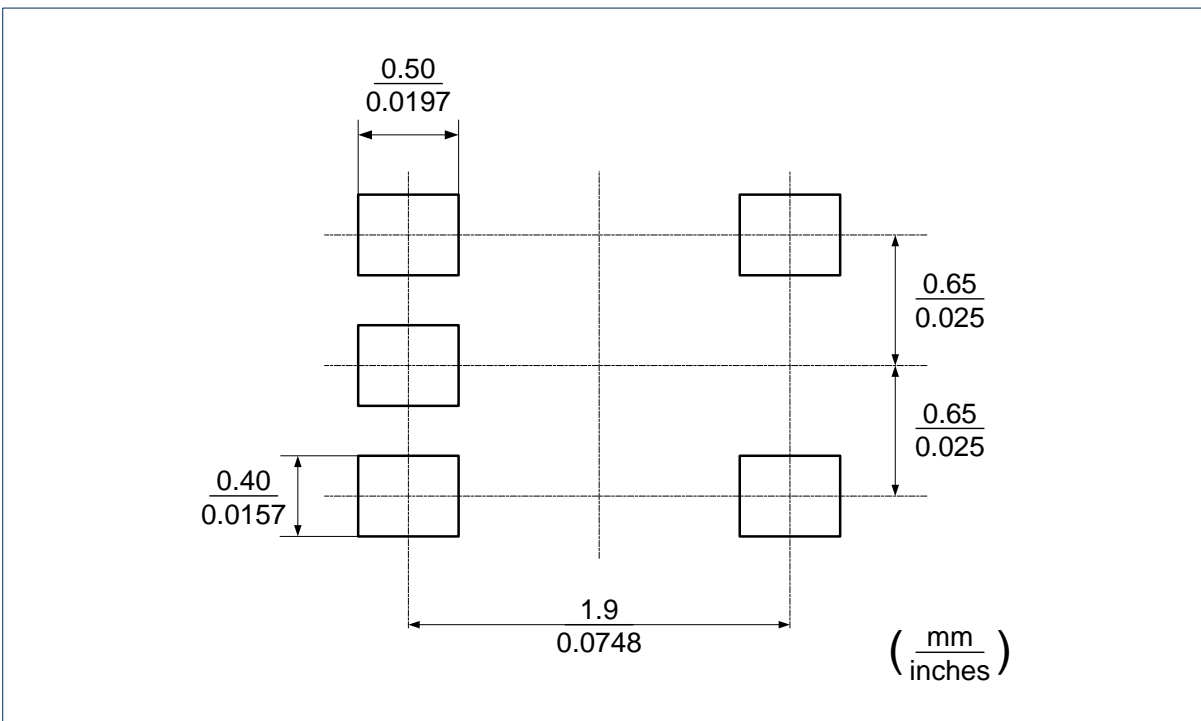



### Package Outlines (continued)

#### DIMENSIONS, SOIC-8L

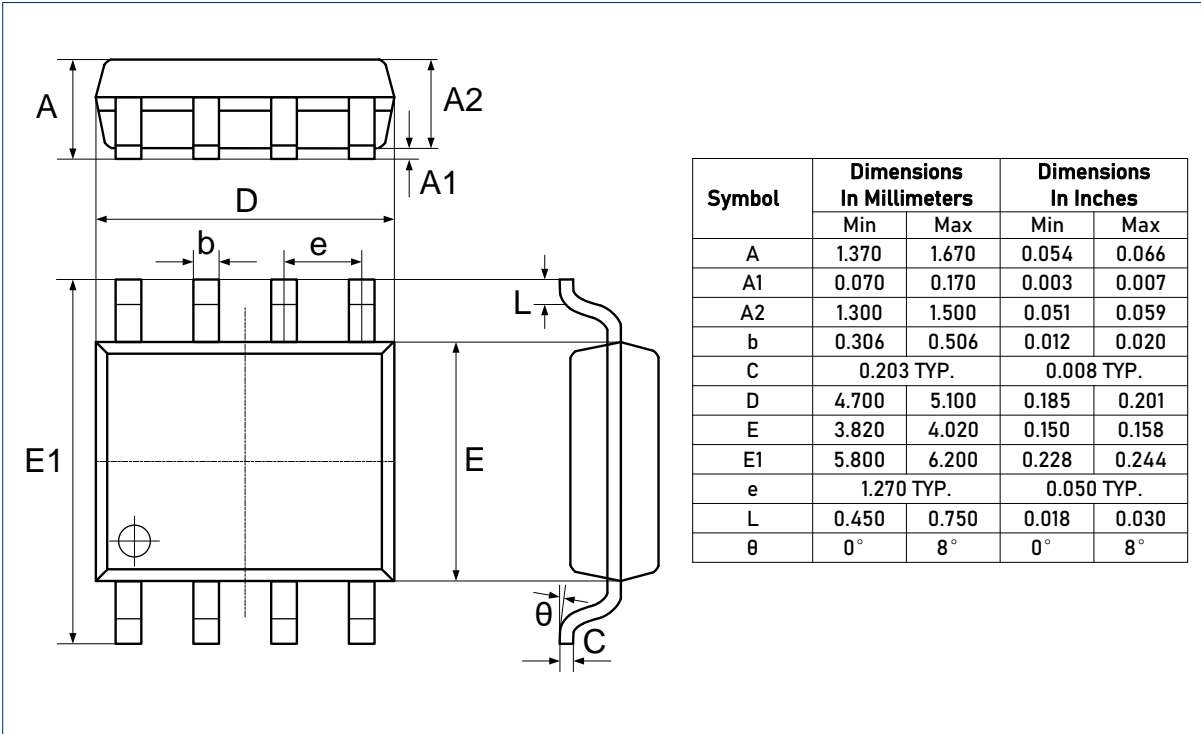

#### RECOMMENDED SOLDERING FOOTPRINT, SOIC-8L

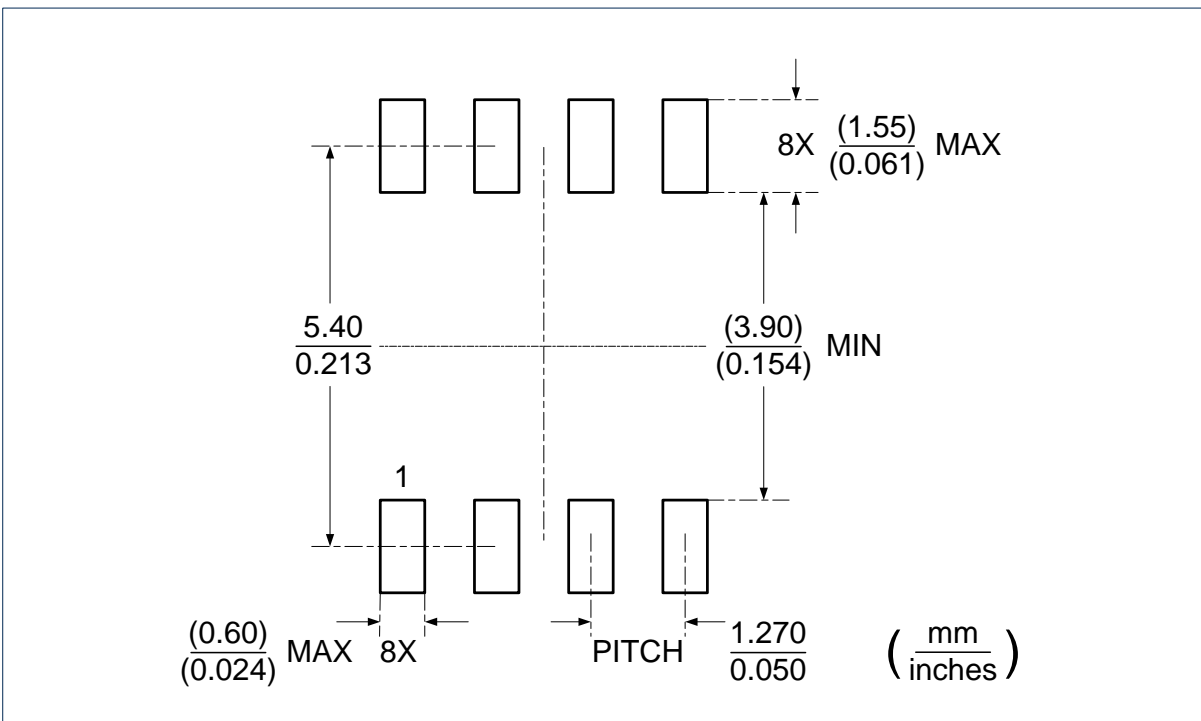

CAUTION: These devices are sensitive to electrostatic discharge; follow proper IC Handling Procedures.  
Linearin and designs are registered trademarks of Linearin Technology Corporation.  
© Copyright Linearin Technology Corporation. All Rights Reserved.  
All other trademarks mentioned are the property of their respective owners.

### Package Outlines (continued)

#### DIMENSIONS, MSOP-8L

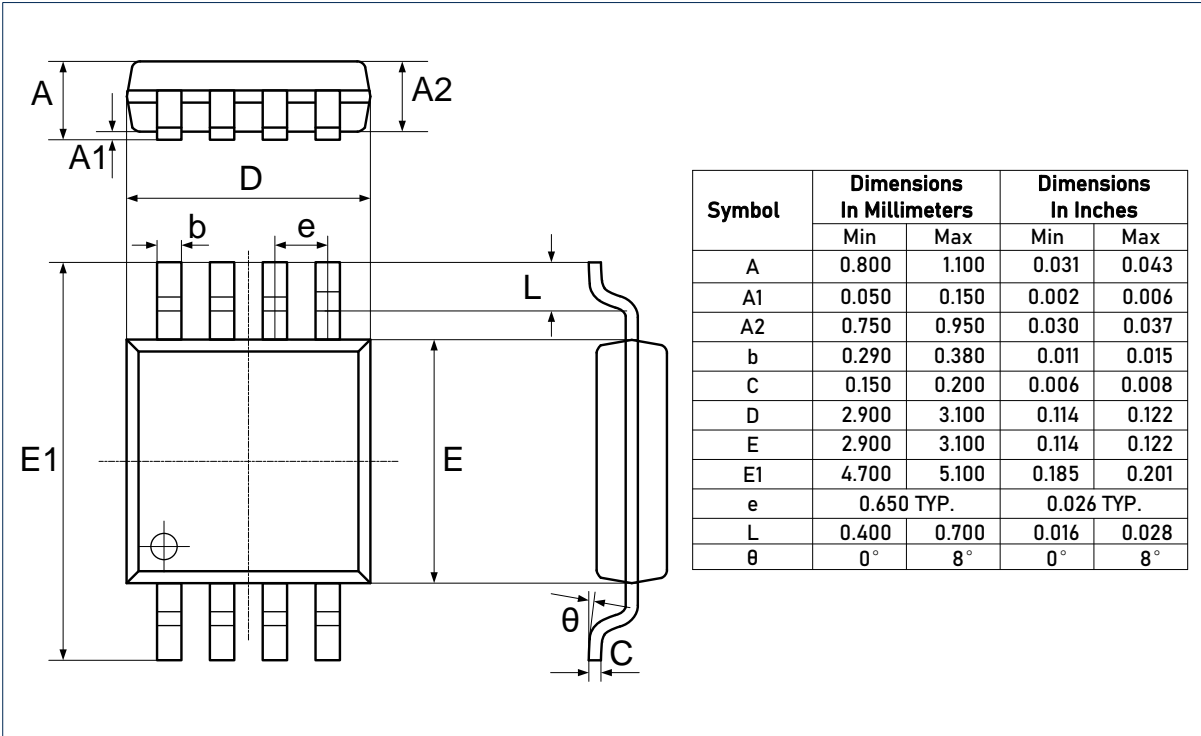

#### RECOMMENDED SOLDERING FOOTPRINT, MSOP-8L

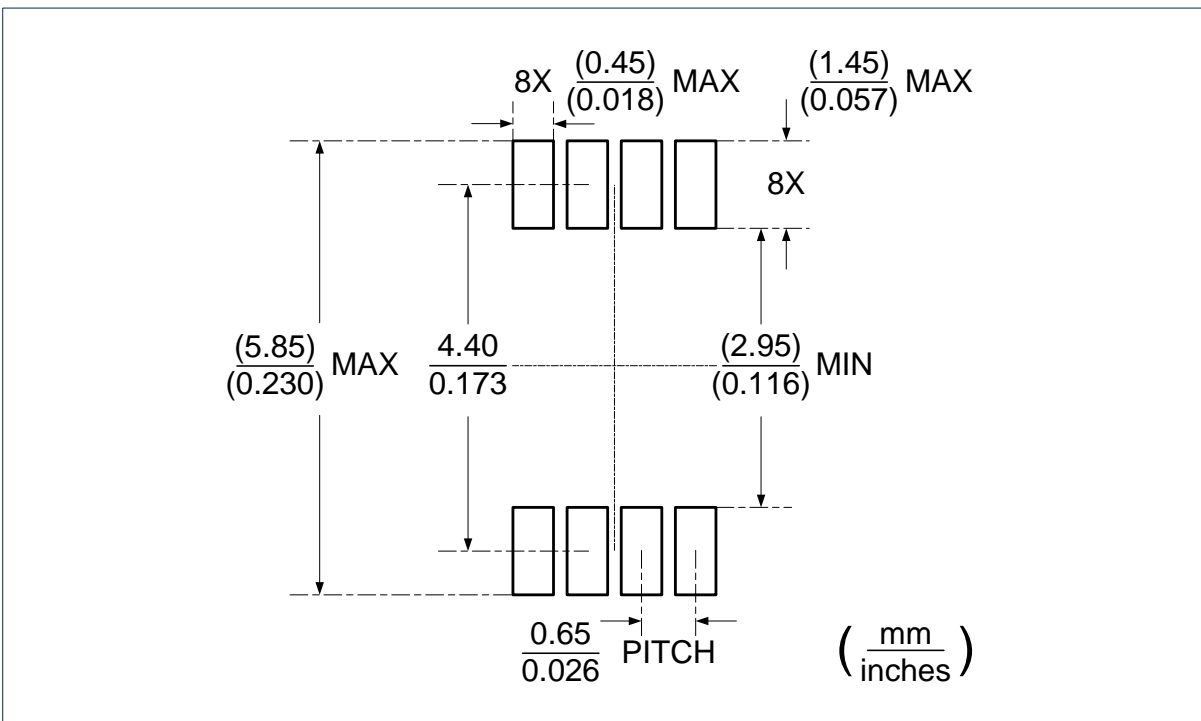

CAUTION: These devices are sensitive to electrostatic discharge; follow proper IC Handling Procedures.  
 Linearin and designs are registered trademarks of Linearin Technology Corporation.  
 © Copyright Linearin Technology Corporation. All Rights Reserved.  
 All other trademarks mentioned are the property of their respective owners.

## Package Outlines (continued)

DIMENSIONS, DFN2x2-8L

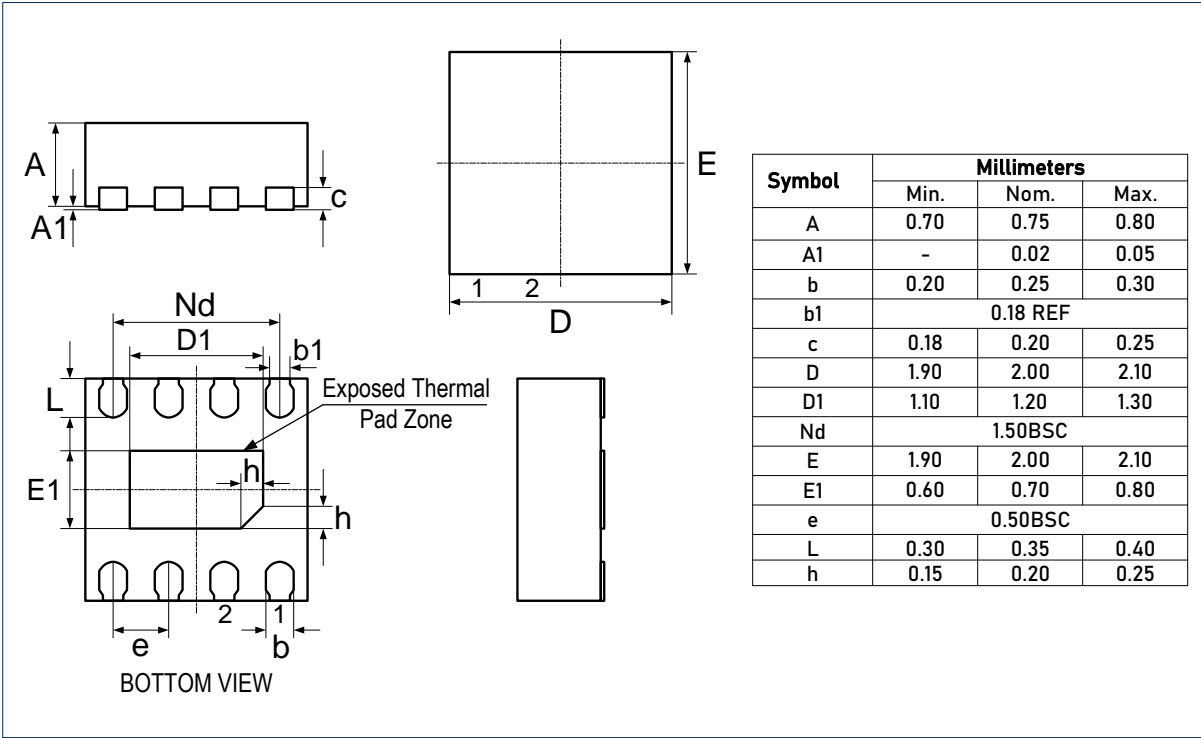

RECOMMENDED SOLDERING FOOTPRINT, DFN2x2-8L

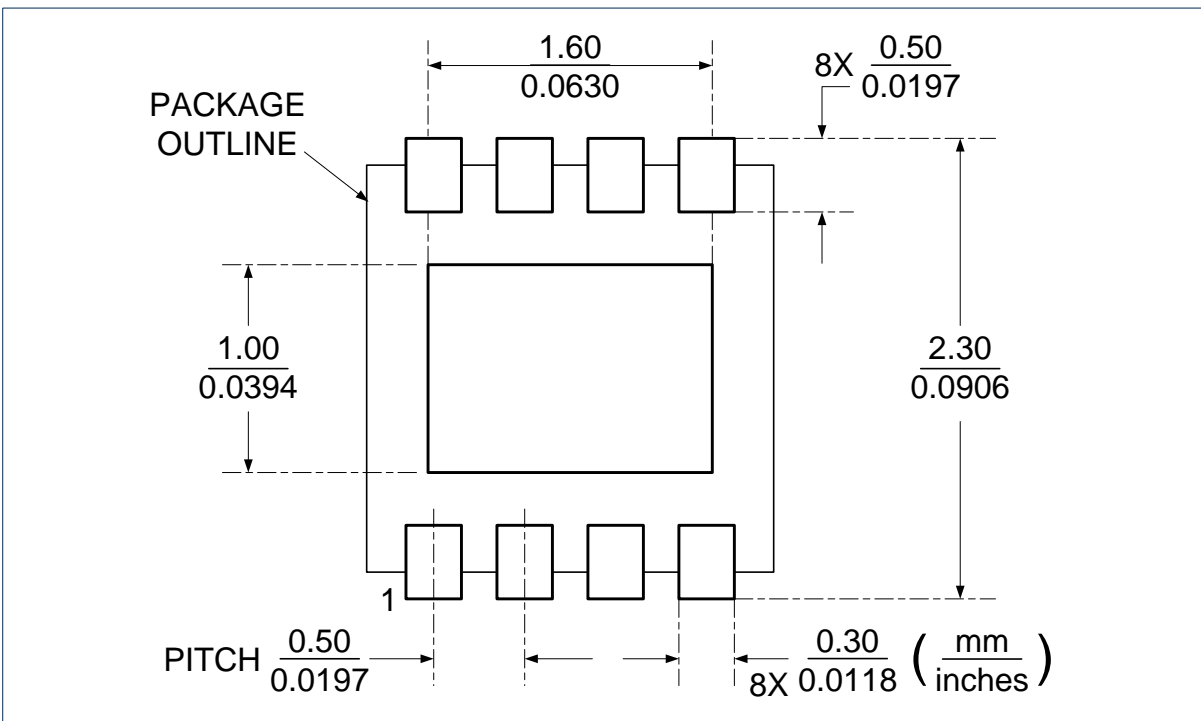

CAUTION: These devices are sensitive to electrostatic discharge; follow proper IC Handling Procedures.  
Linearin and designs are registered trademarks of Linearin Technology Corporation.  
© Copyright Linearin Technology Corporation. All Rights Reserved.  
All other trademarks mentioned are the property of their respective owners.

### Package Outlines (continued)

#### DIMENSIONS, SOIC-14L

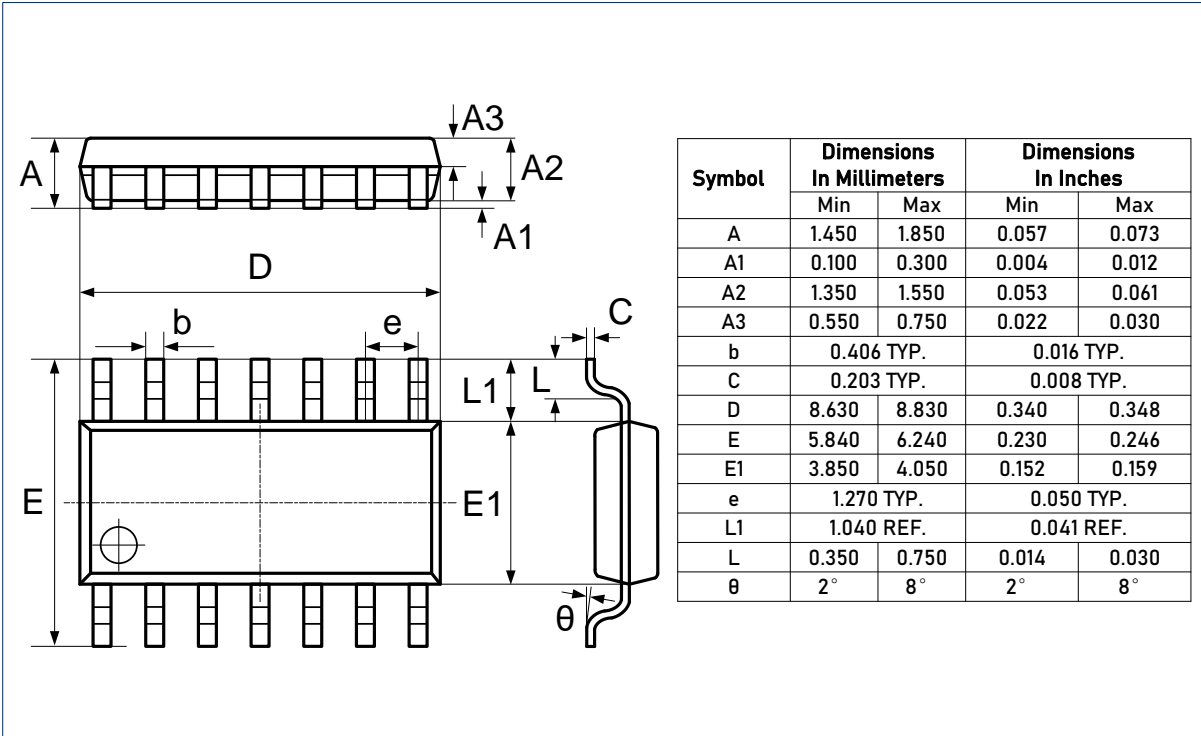

#### RECOMMENDED SOLDERING FOOTPRINT, SOIC-14L

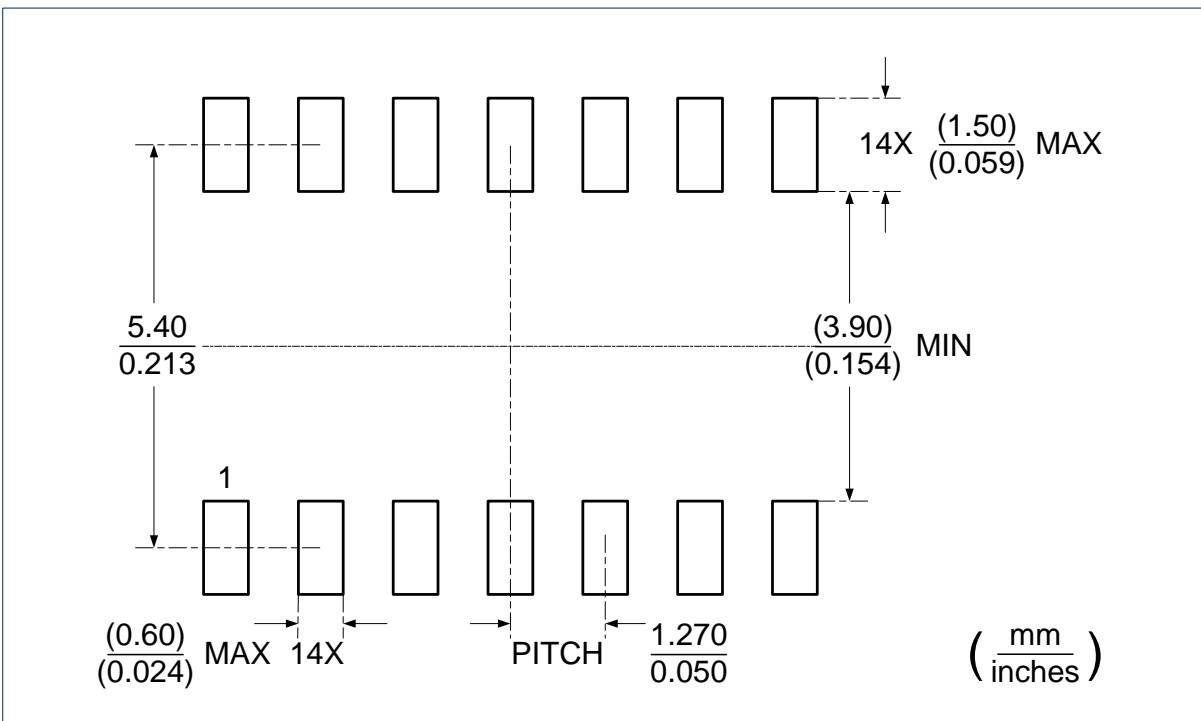

CAUTION: These devices are sensitive to electrostatic discharge; follow proper IC Handling Procedures.  
 Linearin and designs are registered trademarks of Linearin Technology Corporation.  
 © Copyright Linearin Technology Corporation. All Rights Reserved.  
 All other trademarks mentioned are the property of their respective owners.

Package Outlines (continued)

DIMENSIONS, TSSOP-14L

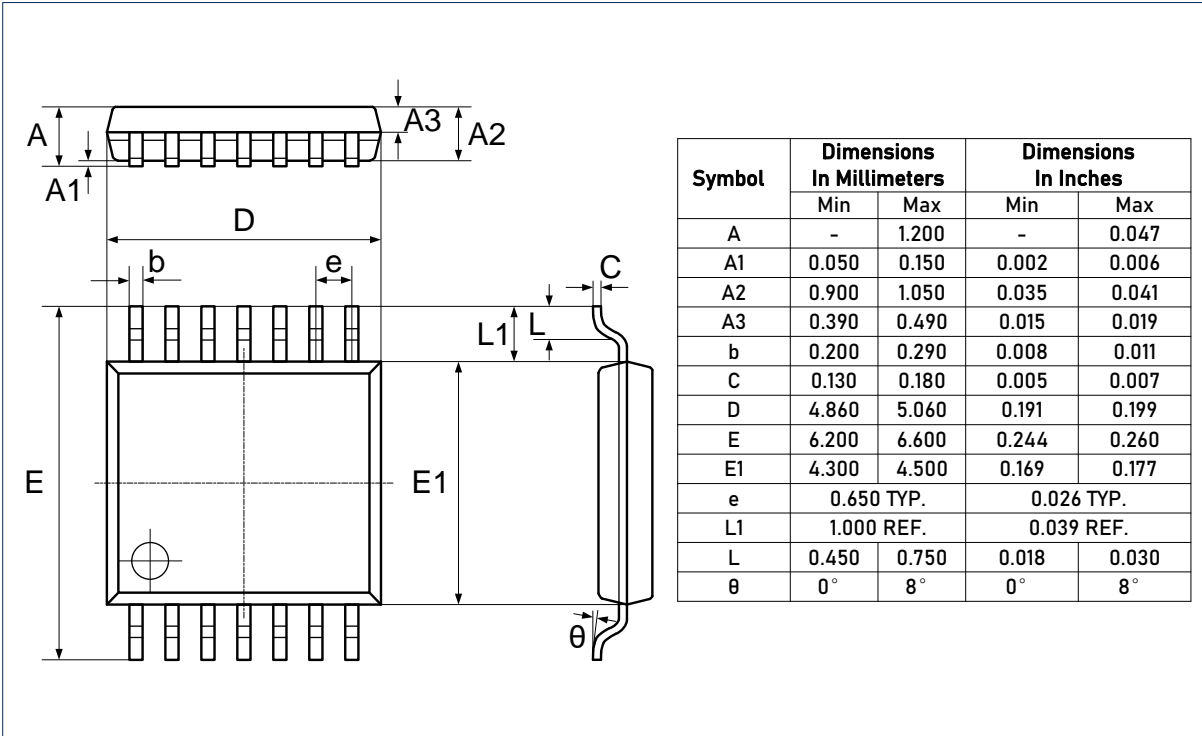

RECOMMENDED SOLDERING FOOTPRINT, TSSOP-14L

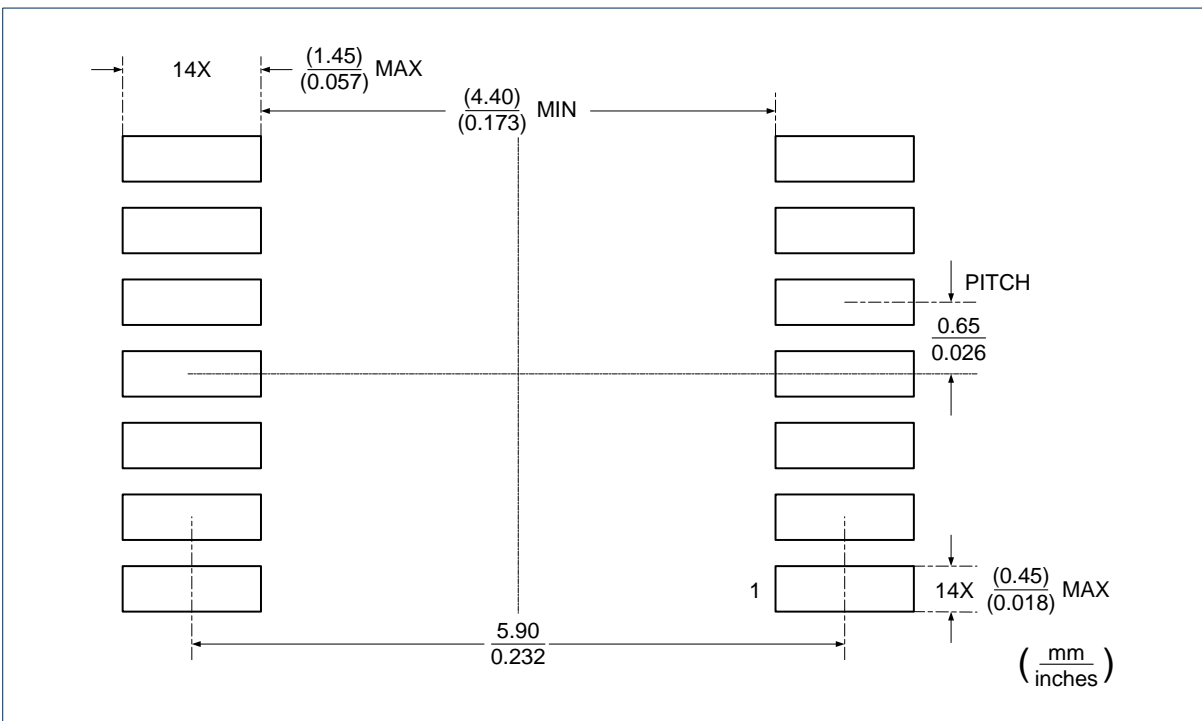

CAUTION: These devices are sensitive to electrostatic discharge; follow proper IC Handling Procedures.  
Linearin and designs are registered trademarks of Linearin Technology Corporation.  
© Copyright Linearin Technology Corporation. All Rights Reserved.  
All other trademarks mentioned are the property of their respective owners.

## IMPORTANT NOTICE

---

Linearin is a global fabless semiconductor company specializing in advanced high-performance high-quality analog/mixed-signal IC products and sensor solutions. The company is devoted to the innovation of high performance, analog-intensive sensor front-end products and modular sensor solutions, applied in multi-market of medical & wearable devices, smart home, sensing of IoT, and intelligent industrial & smart factory (industrie 4.0). Linearin's product families include widely-used standard catalog products, solution-based application specific standard products (ASSPs) and sensor modules that help customers achieve faster time-to-market products. Go to <http://www.linearin.com> for a complete list of Linearin product families.

For additional product information, or full datasheet, please contact with the Linearin's Sales Department or Representatives.