

Temperature Compensated Crystal Oscillator (TCXO)

- Package size (5.0 mm × 3.2 mm × 1.45 mm)
- Ultra high stability VC-TCXO
- Output waveform : CMOS
- Reference weight Typ.72 mg

[1] Product Number / Product Name

(1-1) Product Number / Ordering Code

X1G0053910021xx

last 2 digits code(xx) define Quantity.

The standard is "00", 1 000 pcs/Reel.

(1-2) Product Name / Model Name

TG5032CFN 10.000000 MHz CAGNDA

[2] Operating range

Parameter	Symbol	Specifications			Unit	Conditions
		Min.	Typ.	Max.		
Supply voltage	Vcc	3.135	3.3	3.465	V	-
	GND	0	-	0	V	-
Frequency control voltage	Vc	0.5	1.5	2.5	V	Vc = 1.5 ±1.0 V
Operating temperature range	T_use	-40	-	+85	°C	-
Output load	Load_C	13.5	15	16.5	pF	-

[3] Frequency characteristics

(1) Frequency characteristics (Vcc = 3.3 V, GND = 0.0 V, Vc = 1.5 V, Load = 15 pF, T_use = +25 °C)

Parameter	Symbol	Specifications			Unit	Conditions
		Min.	Typ.	Max.		
Output Frequency	fo	-	10	-	MHz	-
Frequency tolerance *1	f_tol	-1.0	-	+1.0	x10 ⁻⁶	T_use = +25 °C ±2 °C After 2 reflows *2
Frequency / temperature characteristics	fo-Tc	-0.1	-	+0.1	x10 ⁻⁶	T_use = -40 °C to +85 °C (Reference to (fmax+fmin)/2)
Frequency / load coefficient	fo-Load	-0.1	-	+0.1	x10 ⁻⁶	Load ±10 %
Frequency / voltage coefficient	fo-Vcc	-0.1	-	+0.1	x10 ⁻⁶	Vcc ±5 %
Frequency aging	f_age	-0.5	-	+0.5	x10 ⁻⁶	T_use = +25 °C first year
		-3.0	-	+3.0	x10 ⁻⁶	T_use = +25 °C 20 years
Holdover stability, constant temperature	-	-0.01	-	+0.01	x10 ⁻⁶	T_use = +25 °C, 24 hours (after 10 days of continuous operation)
Holdover stability, constant temperature	-	-0.04	-	+0.04	x10 ⁻⁶	T_use = +25 °C, 24 hours (after 48 hours of continuous operation)
Holdover stability (Free-run accuracy)	-	-4.6	-	+4.6	x10 ⁻⁶	*3

*1 Include initial frequency tolerance and frequency deviation after reflow cycles.

*2 Measured in the elapse of 24 hours after reflow soldering.

*3 This includes initial frequency tolerance, frequency / temperature characteristics, frequency / load coefficient, frequency/voltage coefficient and frequency aging (+25 °C, 20 years) .

(2) Frequency control characteristics

(Vcc = 3.3 V, GND = 0.0 V, Vc = 1.5 V, Load = 15 pF, T_use = +25 °C)

Parameter	Symbol	Specifications			Unit	Conditions
		Min.	Typ.	Max.		
Frequency control range	f_cont	-10	-	-5	x10 ⁻⁶	Vc = 0.5 V
		+5	-	+10	x10 ⁻⁶	Vc = 2.5 V
Input impedance	Zin	100	-	-	kΩ	Vc = 1.5 V
Frequency change polarity	-	Positive polarity			-	-

[4] Electrical characteristics

(Vcc = 3.3 V, GND = 0.0 V, Vc = 1.5 V, Load = 15 pF, T_use = +25 °C)

Parameter	Symbol	Specifications			Unit	Conditions
		Min.	Typ.	Max.		
Current consumption	Icc	-	-	5.0	mA	-
High level output voltage	VoH	90 %	-	-	V	-
Low level output voltage	VoL	-	-	10 %	V	-
Rise time	tr	-	-	8.0	ns	10 % Vcc to 90 % Vcc level
Fall time	tf	-	-	8.0	ns	90 % Vcc to 10 % Vcc level
Symmetry	SYM	45	-	55	%	50 % Vcc Level

[For other general specifications, please refer to the attached Full Data Sheet below]

Ultra high stability temperature compensated crystal oscillator

Product name : TG5032CFN / TG5032SFN

Features

- Ultra high stability ($\leq 0.1 \times 10^{-6}$)
- Low phase noise
- Frequency range : 10 MHz to 40 MHz
- Output : CMOS, Clipped sine wave
- Supply voltage : 2.375 to 3.63 V
- External dimensions : 5.0 × 3.2 × 1.45 mm
- Small size package (4 pads)
- Pb free.
- Complies with EU RoHS directive.

Applications

- Small Cells
- Stratum3
- Femtocell
- Network system etc..

Outline dimensions

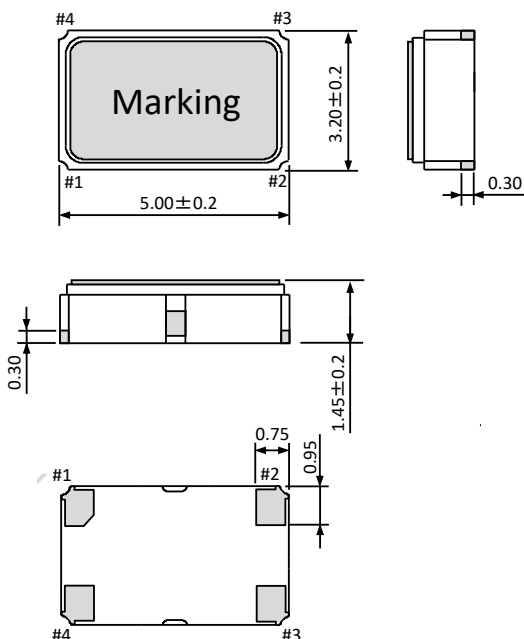

Pin information

Pin	Connections	
	VC-TCXO	TCXO
1	V _c	N.C.
2	GND	
3	OUT	
4	V _{cc}	



TG5032CFN (CMOS output)



TG5032SFN (Clipped sine wave output)

Description

This product is ultra high stability temperature compensated crystal oscillator of CMOS and Clipped sine wave outputs using fundamental oscillation of Crystal unit. This has realized a low phase noise in frequency 10 to 40 MHz, and it is suitable for the reference clock include Small Cells.

This allows the product to be compliant with various standards including GR-1244-CORE Stratum3, G.8262.1, G.8273.2 (Class A,B).

Characteristics

Frequency / temperature characteristics

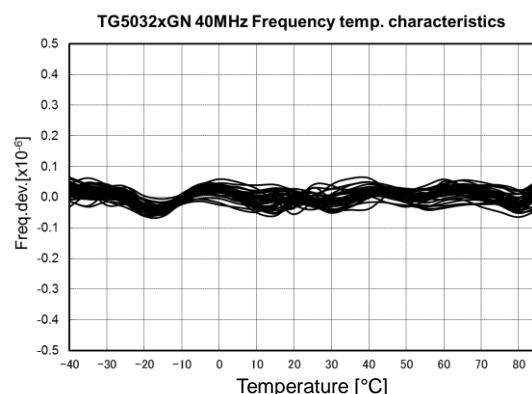
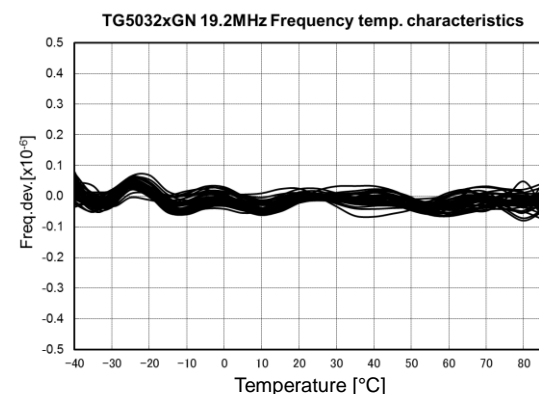

1. Product Number / Product Name

(1-1) Product Number / Ordering Code

TG5032CFN: X1G005391xxxx00 (Please contact Epson for details of number xxxx)

TG5032SFN: X1G005401xxxx00 (The last 2 digits code (00) define Quantity. 1 000 pcs/Reel)

(1-2) Product Name / Model Name (Standard form)

T G 5 0 3 2 C F N 10.000000 M H Z C A G N D A

① ② ③ ④ ⑤ ⑥ ⑦ ⑧ ⑨

① Model

② Output

③ Frequency

④ Supply voltage

⑤ Frequency / temperature

⑥ Operation temperature

⑦ OE function (H: Non)

⑧ Vc function (Non Filter)

⑨ Internal identification code ("A" is default)

② Output	⑤ Frequency / temperature	⑧ Vc function Filter option
C CMOS	A $\pm 0.1 \times 10^{-6}$	N Non Vc
S Clipped sine Wave	B $\pm 0.28 \times 10^{-6}$	E Vc = 1.65 V Non Filter
		D Vc = 1.5 V
④ Supply voltage	⑥ Operation temperature	
C 3.3 V	G -40 °C to +85 °C	
	⑦ OE function	
	N Non OE function	

2. Electrical characteristics

1) Absolute maximum ratings

Parameter	Symbol	Unit	Min.	Typ.	Max	Notes
Supply voltage	V _{CC-GND}	V	-0.5	-	+4.0	
Storage temperature	T _{stg}	°C	-40	-	+90	Store as bare product after packing
Frequency control voltage	V _{C-GND}	V	-0.5	-	V _{CC} +0.5	V _C Terminal

2) Operating conditions

Parameter	Symbol	Unit	Min.	Typ.	Max	Notes
Supply voltage	V _{CC}	V	2.375	-	3.63	Supply voltage range
			2.85	3.0	3.15	V _{CC} = 3.0 V Type
	GND		0.0	-	0.0	
Operating temperature range	T _{use}	°C	-40	+25	+85	Standard
Frequency control voltage	V _C	V	GND	N.C.	-	V _C Terminal / TCXO
			0.5	1.5	2.5	V _C Terminal / VC-TCXO
			0.65	1.65	2.65	
Output load condition	Load _C	pF	13.5	15	16.5	CMOS output
	Load _C	pF	9	10	11	Clipped sine wave
	Load _R	kΩ	9	10	11	
	C _c	μF	0.01	-	-	DC-cut capacitor *1 Clipped sine wave

*1 DC-cut capacitor is not included in this TCXO. Please attach an external DC-cut capacitor (0.01 μF Min.) to the out pin.

3-1) Frequency characteristics

(V_{CC} = Typ., GND = 0.0 V, V_C = Typ. V, Load = Typ., T_{use} = +25 °C)

Parameter	Symbol	Unit	Min.	Typ.	Max	Notes
Output frequency	f _o	MHz	10	-	40	Standard frequency list
			10, 12.8, 19.2, 20, 24, 576, 25, 25.6, 26, 30.72, 38.4, 38.88, 40			
Frequency tolerance *2 (T _{use} =+25 °C ±2 °C) (Reflow cycles : 2 times)	f _{tol}	× 10 ⁻⁶	-1.0	-	+1.0	
Frequency / temperature characteristics (Reference to (f _{max} +f _{min})/2.)	f _{o-Tc}	× 10 ⁻⁶	-0.10	-	+0.10	T _{use} = -40 °C to +85 °C (Standard)
			-0.14	-	+0.14	T _{use} = -40 °C to +85 °C
			-0.25	-	+0.25	T _{use} = -40 °C to +85 °C
			-0.28	-	+0.28	T _{use} = -40 °C to +85 °C
Frequency / load coefficient	f _{o-Load}	× 10 ⁻⁶	-0.10	-	+0.10	Load ±10 %
			-0.05	-	+0.05	Load ±2 %
Frequency / voltage coefficient	f _{o-V_{CC}}	× 10 ⁻⁶	-0.10	-	+0.10	V _{CC} ±5 %
			-0.05	-	+0.05	V _{CC} ±2 %
Frequency slope	-	× 10 ⁻⁶ / °C	-0.10	-	+0.10	Minimum of 1 frequency reading every 2 °C, over the operating temperature range (1 °C/minute max.)
Hysteresis	-	× 10 ⁻⁶	-0.20	-	+0.20	Frequency measured before and after at +25 °C.
Frequency aging *6	f _{age}	× 10 ⁻⁶	-0.5	-	+0.5	T _{use} = +25 °C, First year
			-3.0	-	+3.0	T _{use} = +25 °C, 20 years
Holdover stability (Constant temperature)	-	× 10 ⁻⁶	-0.01	-	+0.01	T _{use} = +25 °C, 1 day *3
			-0.04	-	+0.04	T _{use} = +25 °C, 1 day *4
Holdover stability (Free-run accuracy)	-	× 10 ⁻⁶	-4.6	-	+4.6	*5
Acceleration sensitivity	-	× 10 ⁻⁹ / G	-	2.0	-	3 axes, 30-1500 Hz

*2 Measured 24 hours after reflow soldering.

*3 After 10 days of continuous operation.

*4 After 48 hours of continuous operation.

*5 This includes initial frequency tolerance, frequency / temperature characteristics, frequency / load coefficient, frequency/voltage coefficient and frequency aging (+25 °C, 20 years)

*6 Aging stability is estimated from environmental reliability tests and the expected amount of the frequency variation over time. It is not intend as a guarantee of performance over the product-life cycle

3-2) Frequency control characteristics ($V_{CC} = \text{Typ.}$, $GND = 0.0 \text{ V}$, $V_C = \text{Typ. V}$, $\text{Load} = \text{Typ.}$, $T_{\text{use}} = +25 \text{ }^\circ\text{C}$)

Parameter	Symbol	Unit	Min.	Typ.	Max	Notes
Frequency control range	f_{cont}	$\times 10^{-6}$	-10.0 +5.0	-	-5.0 +10.0	$V_C = 1.5 \text{ V} \pm 1.0 \text{ V}$, $V_C = 1.65 \text{ V} \pm 1.0 \text{ V}$
Linearity	-	%	-10	-	+10	
Input impedance	Z_{IN}	$\text{k}\Omega$	100	-	-	$V_C\text{-GND(DC)}$, $V_C = \text{Typ.}$
Frequency change polarity	-	-	Positive polarity			

4) Electrical Characteristics($V_{CC} = \text{Typ.}$, $GND = 0.0 \text{ V}$, $V_C = \text{Typ. V}$, $\text{Load} = \text{Typ.}$, $T_{\text{use}} = +25 \text{ }^\circ\text{C}$)

Parameter	Symbol	Unit	Min.	Typ.	Max	Notes
Current consumption	I_{CC}	mA	-	-	5.0	Clipped sine wave (Standard)
			-	-	3.0	Clipped sine wave (Option)
			-	-	5.0	CMOS (~26 MHz)
			-	-	6.0	CMOS (~40 MHz)
Start up time	t_{str}	ms	-	1.0	5.0	$t=0$ at 90 % V_{CC}
Rise time	t_r	ns	-	-	8.0	10 % V_{CC} to 90 % V_{CC} level CMOS output
Fall time	t_f	ns	-	-	8.0	90 % V_{CC} to 10 % V_{CC} level CMOS output
Symmetry	SYM	%	45	50	55	50 % V_{CC} level CMOS output
			40	50	60	GND level (DC-cut) Clipped sine wave (Option)
High output voltage	V_{OH}	V	90 % V_{CC}	-	-	CMOS output
Low output voltage	V_{OL}	V	-	-	10 % V_{CC}	CMOS output
Output level	V_{pp}	V	0.8	-	-	Clipped sine wave
Phase Noise 10 MHz TCXO mode	L(f)	dBc/Hz	-	-69	-	1 Hz offset
			-	-98	-	10 Hz offset
			-	-125	-	100 Hz offset
			-	-144	-	1 kHz offset
			-	-152	-	10 kHz offset
			-	-153	-	100 kHz offset
			-	-154	-	1 MHz offset
Phase Noise 19.2 MHz TCXO mode () is VC-TCXO mode	L(f)	dBc/Hz	-	-63 (-60)	-	1 Hz offset
			-	-92 (-90)	-	10 Hz offset
			-	-119 (-116)	-	100 Hz offset
			-	-140 (-139)	-	1 kHz offset
			-	-153 (-152)	-	10 kHz offset
			-	-154 (-154)	-	100 kHz offset
			-	-155 (-154)	-	1 MHz offset
Phase Noise 20 MHz TCXO mode () is VC-TCXO mode	L(f)	dBc/Hz	-	-62 (-62)	-	1 Hz offset
			-	-92 (-90)	-	10 Hz offset
			-	-119 (-117)	-	100 Hz offset
			-	-140 (-138)	-	1 kHz offset
			-	-152 (-152)	-	10 kHz offset
			-	-154 (-154)	-	100 kHz offset
			-	-154 (-155)	-	1 MHz offset
Phase Noise 25 MHz TCXO mode () is VC-TCXO mode	L(f)	dBc/Hz	-	-62 (-60)	-	1 Hz offset
			-	-93 (-90)	-	10 Hz offset
			-	-118 (-116)	-	100 Hz offset
			-	-139 (-137)	-	1 kHz offset
			-	-153 (-152)	-	10 kHz offset
			-	-154 (-154)	-	100 kHz offset
			-	-156 (-156)	-	1 MHz offset
Phase Noise 40 MHz TCXO mode () is VC-TCXO mode	L(f)	dBc/Hz	-	-59 (-54)	-	1 Hz offset
			-	-89 (-83)	-	10 Hz offset
			-	-114 (-110)	-	100 Hz offset
			-	-135 (-132)	-	1 kHz offset
			-	-150 (-149)	-	10 kHz offset
			-	-152 (-152)	-	100 kHz offset
			-	-155 (-155)	-	1 MHz offset

3. Characteristics

3-1) "Frequency / Temperature Characteristics"

3-1-1) Standard spec : $\pm 0.1 \times 10^{-6}$ Max. (T_use = -40 °C to +85 °C)

19.2 MHz [N = 40 pcs]

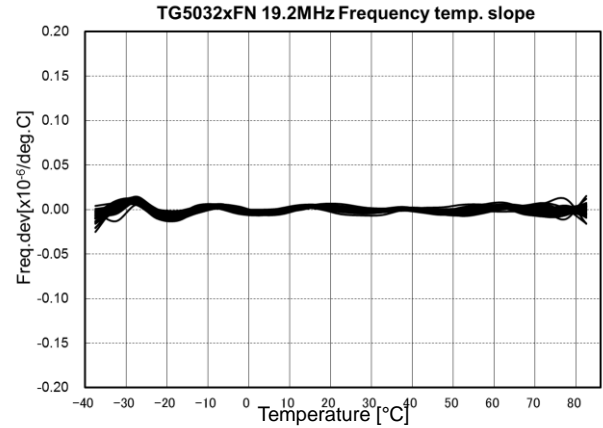
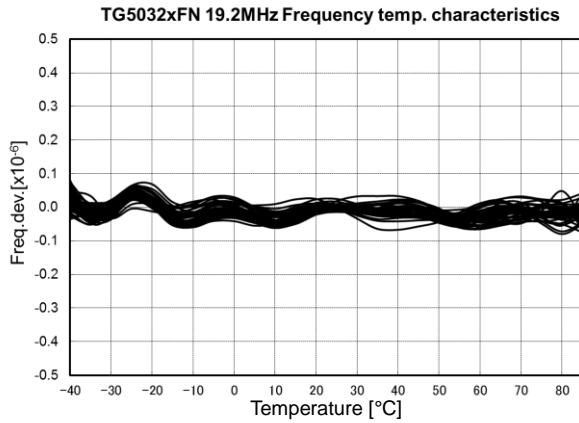

30.72 MHz [N = 40 pcs]

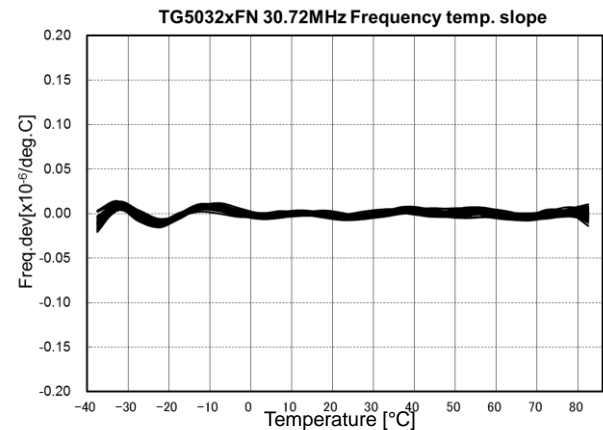
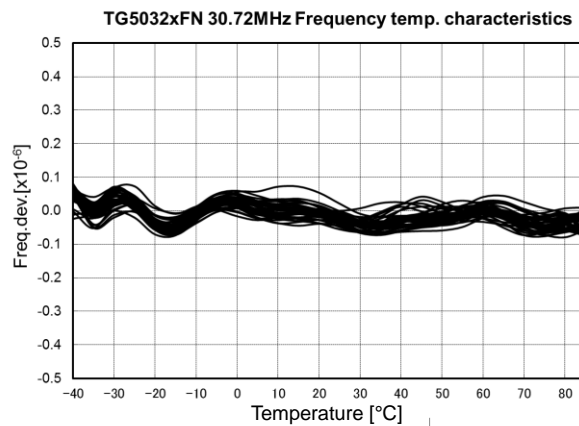

40 MHz [N = 40 pcs]

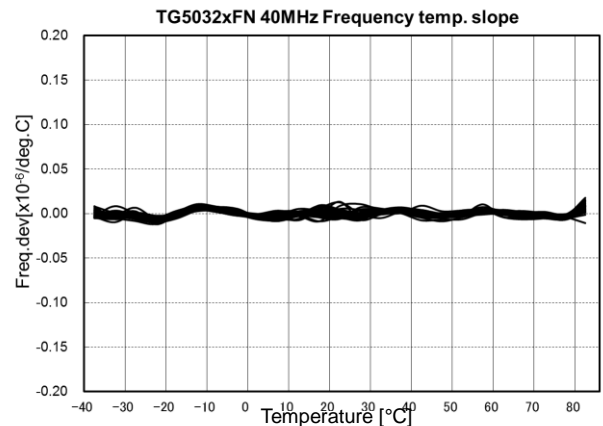
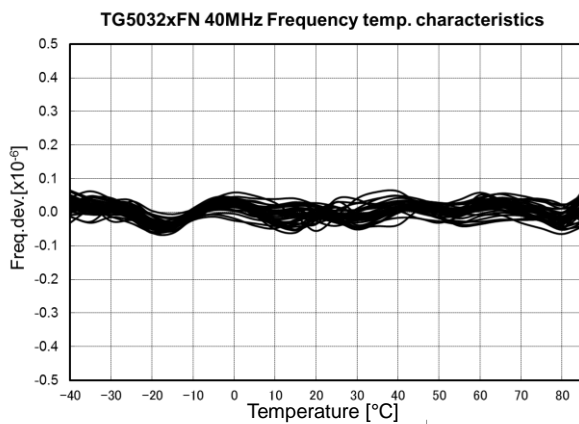

3-2) Frequency Aging (40 MHz) [N = 5 pcs]

* Aging is estimated from environmental reliability tests and the expected amount of frequency variation over time. It is not intended as a guarantee of performance over the product-life cycle.

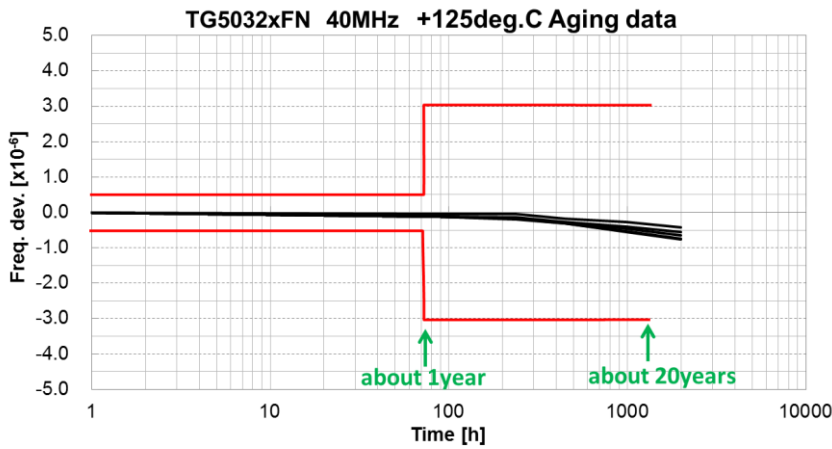

about 1year
 Ave. : -0.10×10^{-6}
 Max. : -0.05×10^{-6}
 Min. : -0.12×10^{-6}

about 20years
 Ave. : -0.54×10^{-6}
 Max. : -0.35×10^{-6}
 Min. : -0.66×10^{-6}

3-3) Holdover Stability (19.2 MHz) [N = 40 pcs]

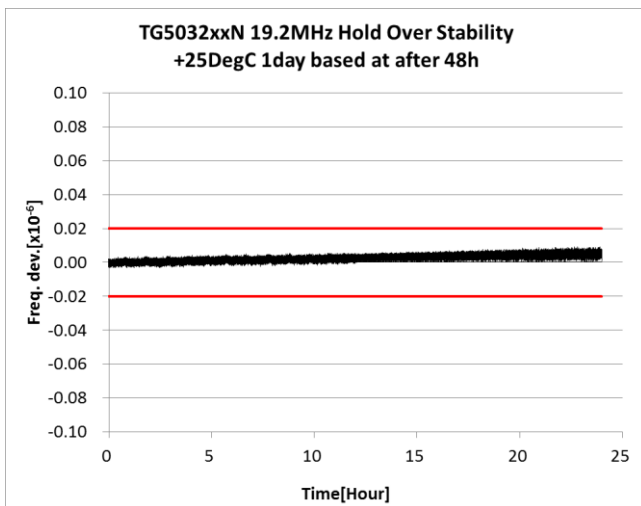

3-4) Frequency Control Characteristics [N = 40 pcs]

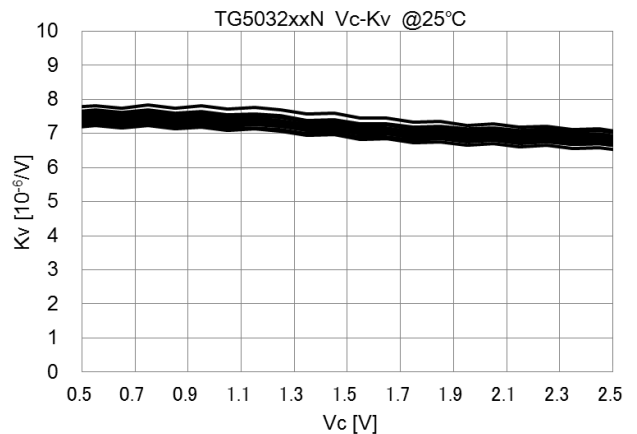
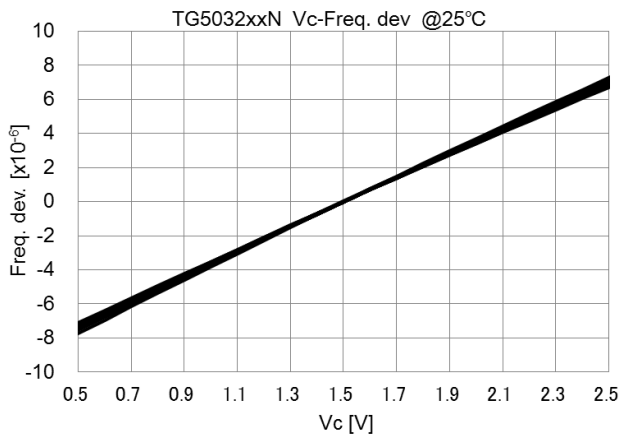

3-5) Current Consumption

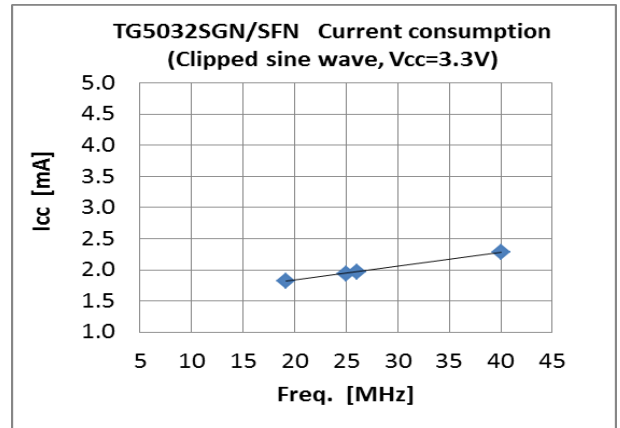
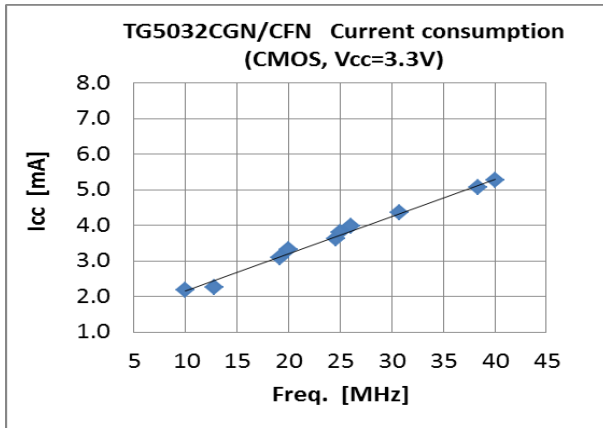

3-6) Rise time / Fall time (at CMOS output)

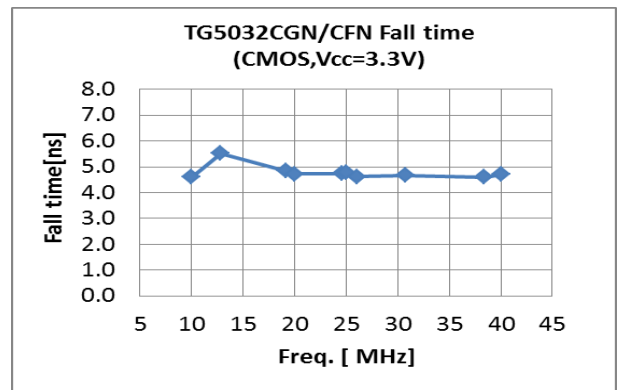
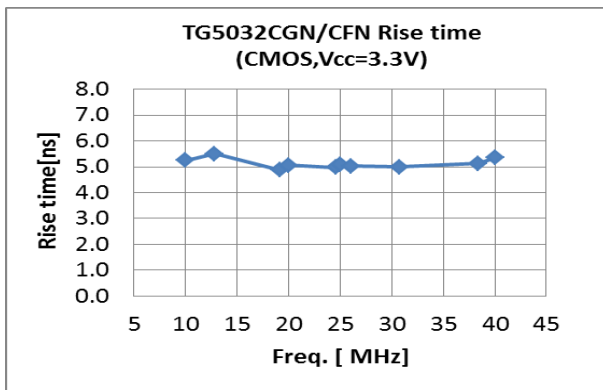

3-7) Output voltage [V_{OH}, V_{OL}] (at CMOS output)

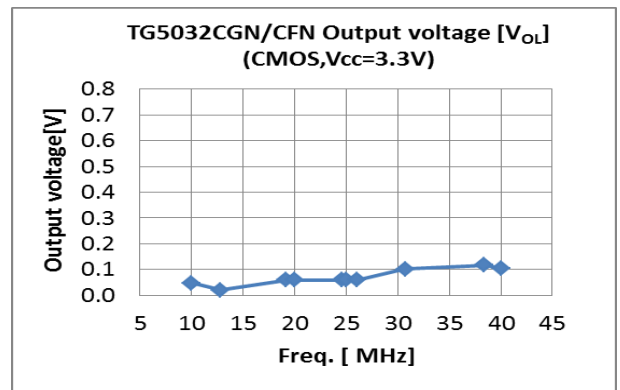
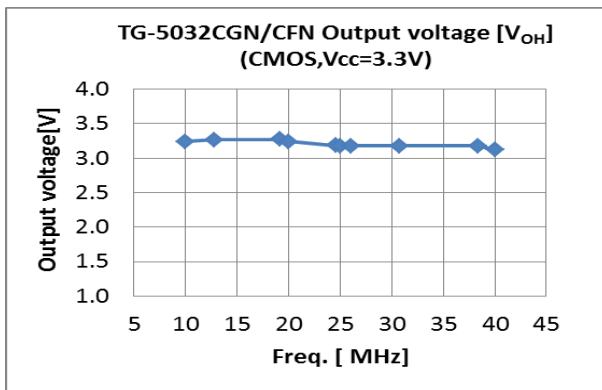

3-8) Symmetry (at CMOS output)

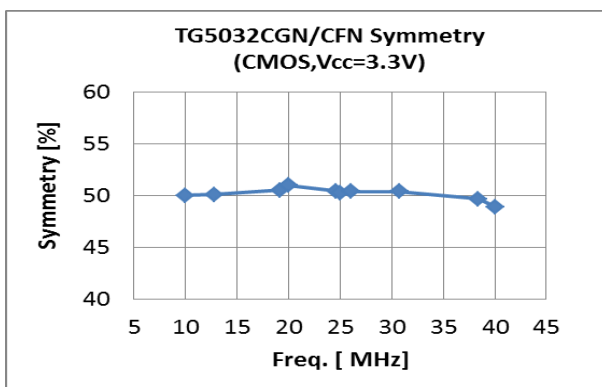

2-9) Output level [V_{PP}] (at Clipped sine wave)

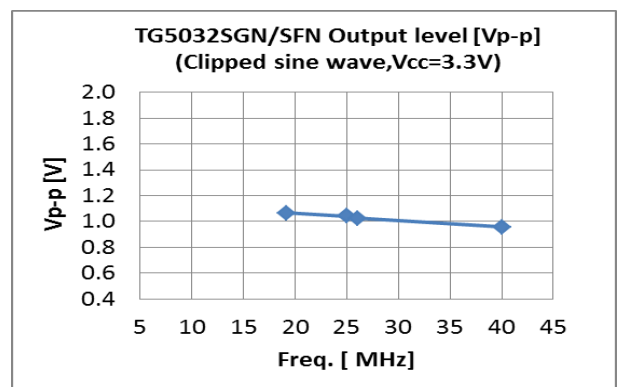

3-10) Start up time (19.2 MHz, 40 MHz)

19.2 MHz

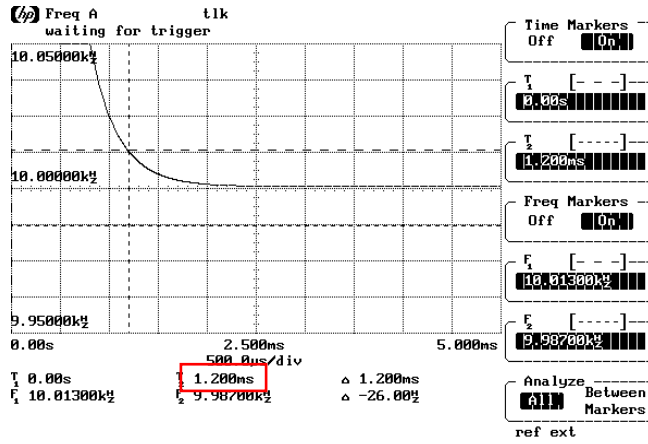

40 MHz

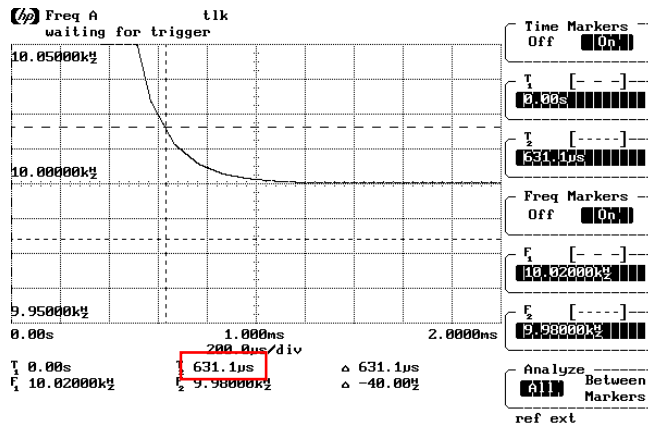

3-11) Phase noise (10 MHz, 19.2 MHz, 20 MHz) [N = 25 pcs]

10 MHz

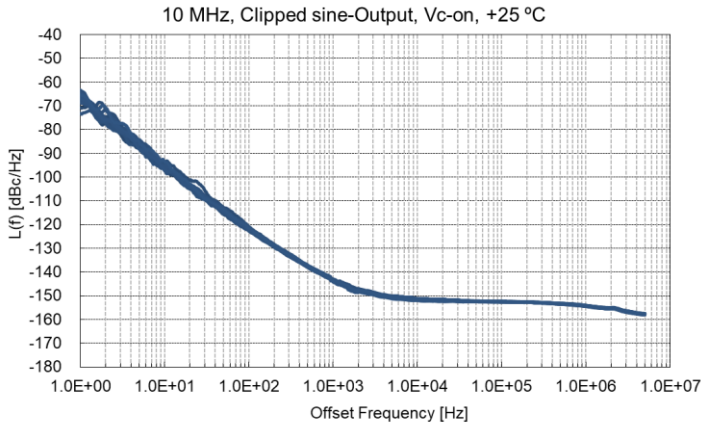

19.2 MHz

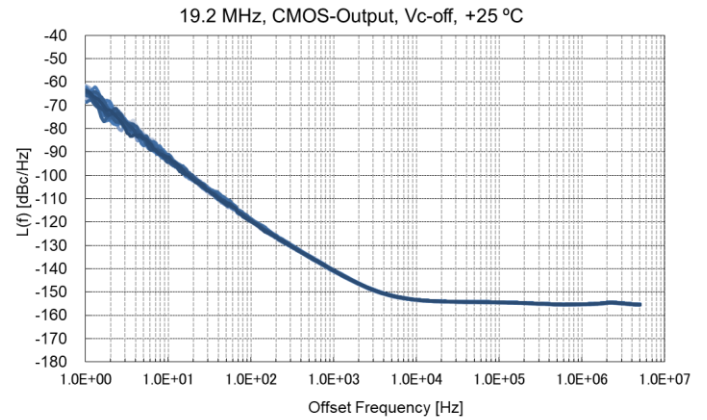
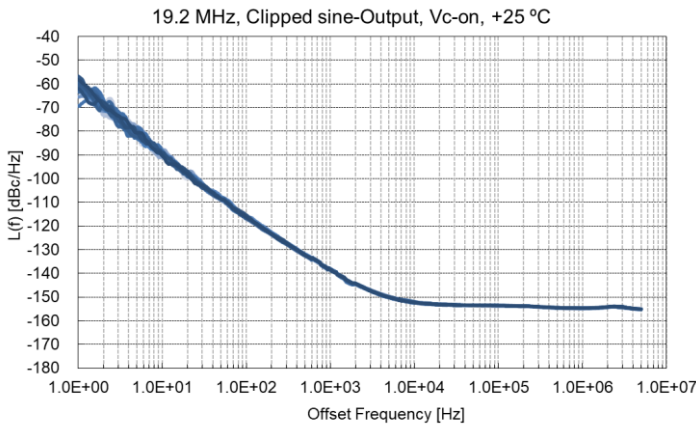

20 MHz

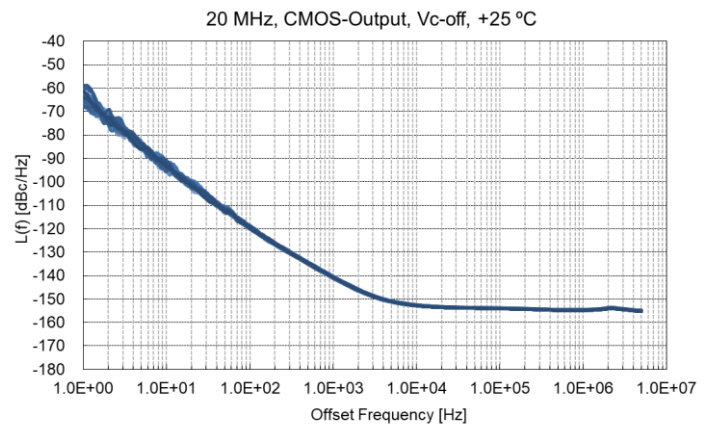
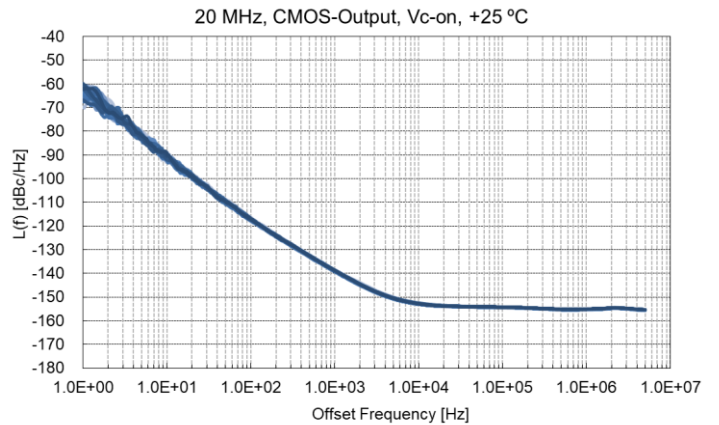
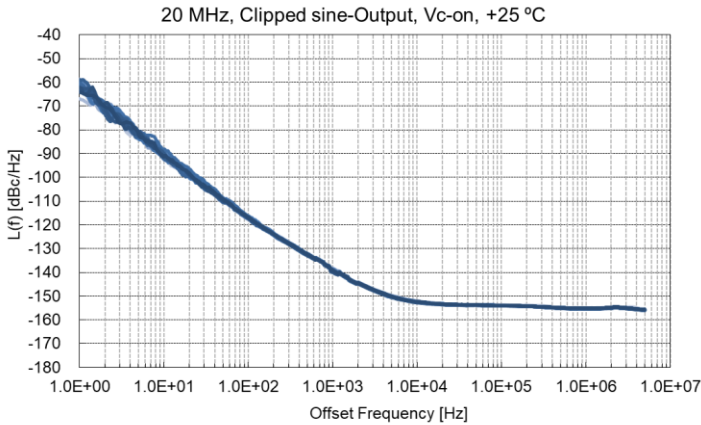

3-11) Phase noise (25 MHz, 30.72 MHz, 40 MHz) [n = 25 pcs]

25 MHz

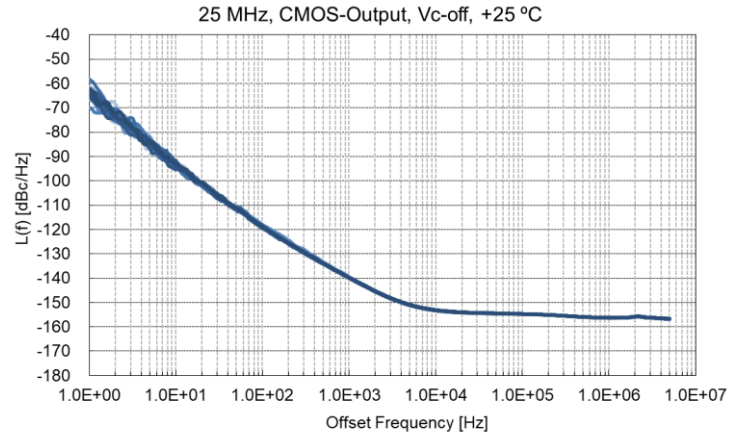
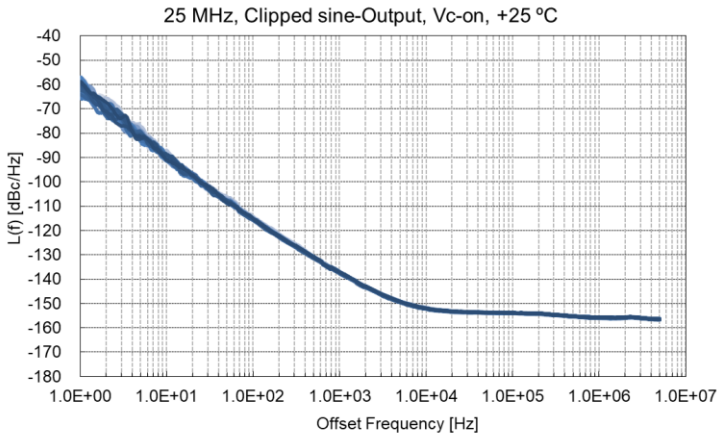

30.72 MHz

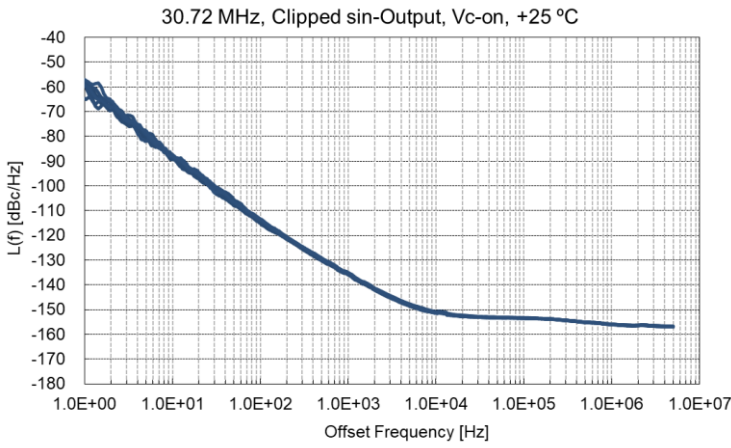

40 MHz

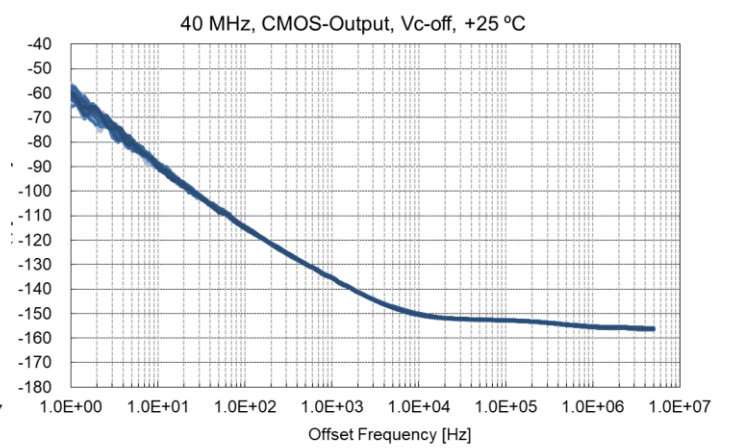
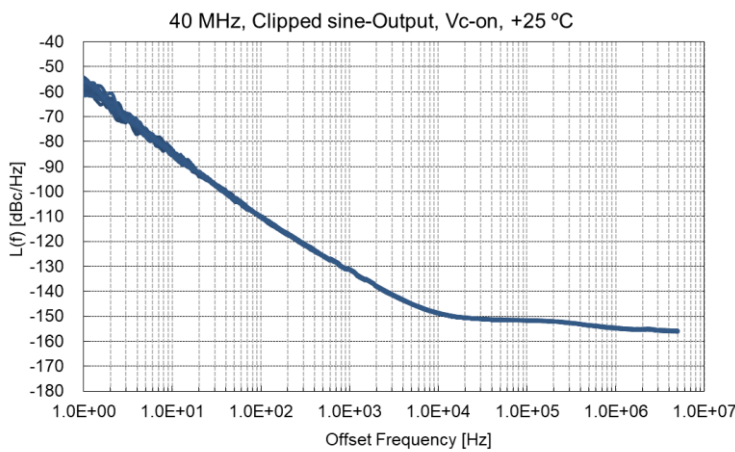

3-12) Short term stability [ADEV] (19.2 MHz) TCXO mode

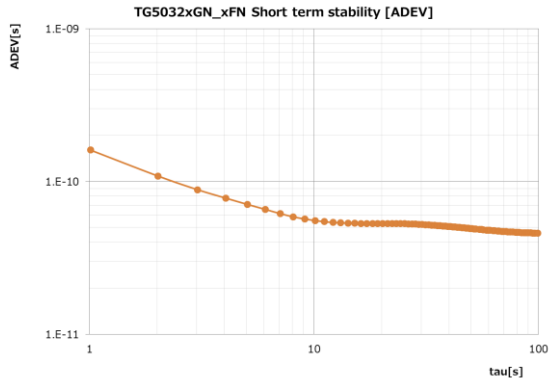

3-13) TDEV (19.2 MHz, Loop BW = 0.1 Hz) Constant temperature : +25 °C

Symmetricon TimeMonitor Analyzer (file=00190.asc)
TDEV: Freq=2.048 MHz; Fw=13.29 Hz; *2015/04/24 08:18:40*
HP 53132A; Test: 190; TG5032CAN_19.2M; div10 fast; 0.1Hz; Samples: 1600000; Fast Sampling; Stop: 1600000; Total Points: 3342613; Ref ch2: 2.048 MHz; T1/T1

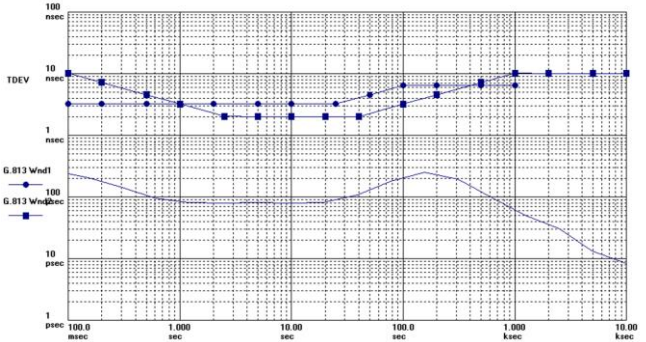

Constant temperature : +70 °C

Symmetricon TimeMonitor Analyzer (file=00236.asc)
TDEV: Freq=2.048 MHz; Fw=13.75 Hz; *2015/05/08 07:58:09*
HP 53132A; Test: 236; TG5032CAN_19.2M; div10 fast; 0.1Hz; Samples: 1600000; Fast Sampling; Stop: 1600000; Total Points: 3629868; Ref ch2: 2.048 MHz; T1/T1

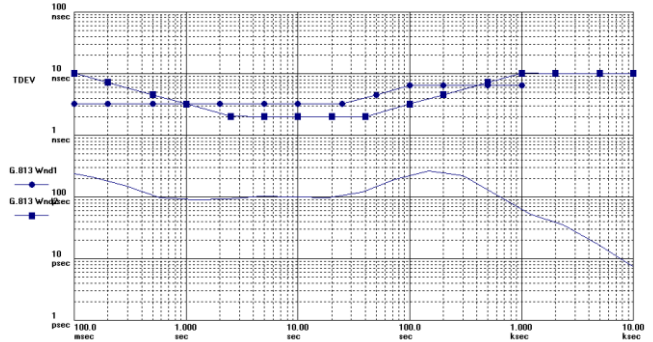

3-14) MTIE (19.2 MHz, Loop BW = 0.1 Hz) Constant temperature : +25 °C

Symmetricon TimeMonitor Analyzer (file=00190.asc)
MTIE: Freq=2.048 MHz; Fw=13.29 Hz; *2015/04/24 08:18:40*
HP 53132A; Test: 190; TG5032CAN_19.2M; div10 fast; 0.1Hz; Samples: 1600000; Fast Sampling; Stop: 1600000; Total Points: 3342613; Ref ch2: 2.048 MHz; T1/T1

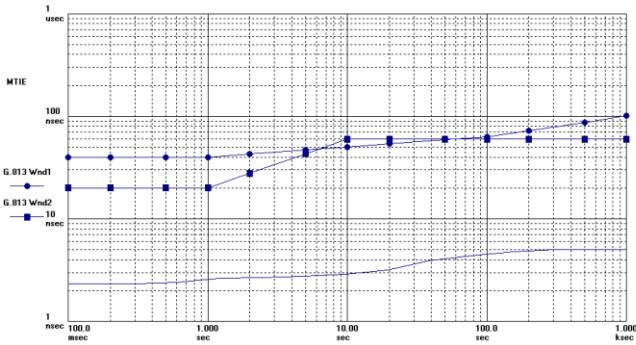

Constant temperature : +70 °C

Symmetricon TimeMonitor Analyzer (file=00236.asc)
MTIE: Freq=2.048 MHz; Fw=13.75 Hz; *2015/05/08 07:58:09*
HP 53132A; Test: 236; TG5032CAN_19.2M; div10 fast; 0.1Hz; Samples: 1600000; Fast Sampling; Stop: 1600000; Total Points: 3629868; Ref ch2: 2.048 MHz; T1/T1

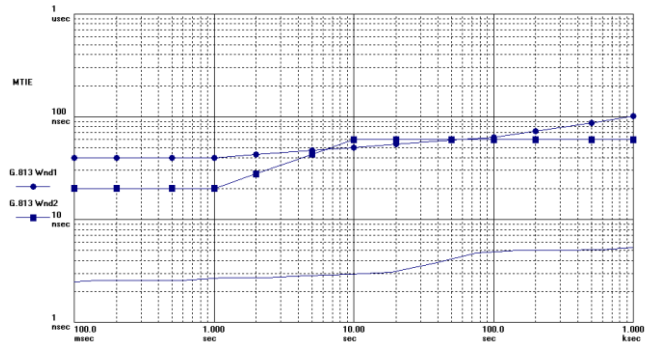

Compliant with G.813 option1 and 2

4. Outline

4-1) Outline dimensions and Pin information

TG5032CFN / SFN

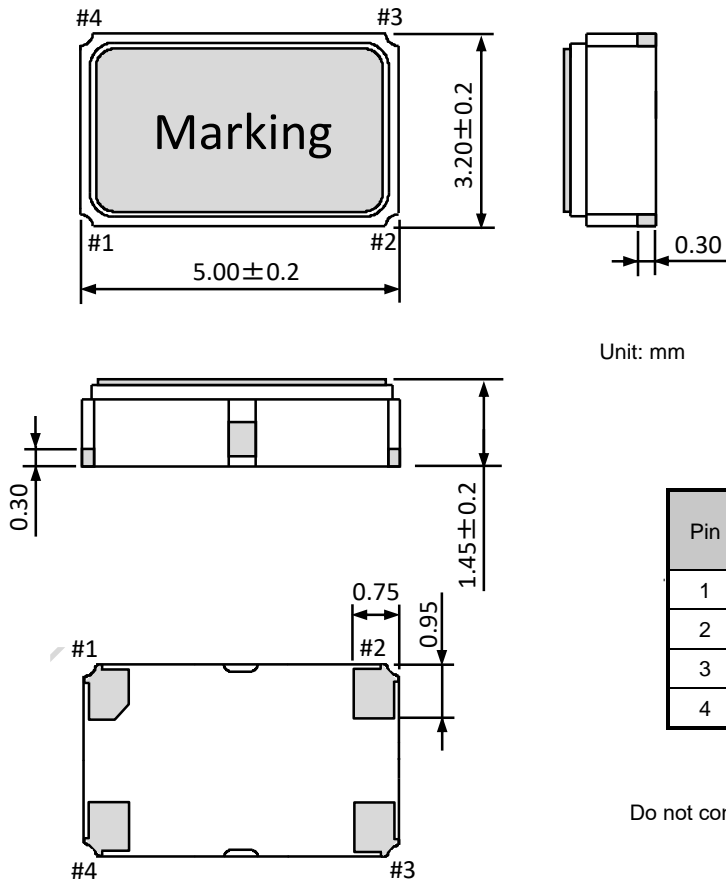

Pin	Connections	
	VC-TCXO	TCXO
1	V _c	N.C.
2	GND	
3	OUT	
4	V _{CC}	

Do not connect "N.C." pin with any other pins (also mutually)

4-2) Soldering pattern

Example of patterning design indicated as follows. In an actual design, please consider mounting density, the reliability of soldering, etc. and check whether performance is optimal.

Soldering pattern of TG5032CFN / SFN

unit : mm

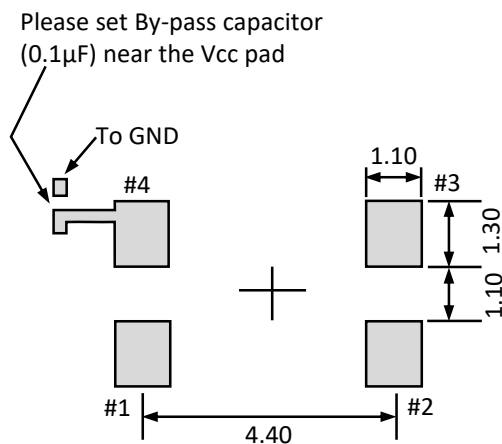

To maintain stable operation, provide a 0.1µF by-pass capacitor at a location as near as possible to the power source terminal of the crystal product (between V_{CC} - GND).

5. Timing chart

5-1) Output waveform (CMOS output)

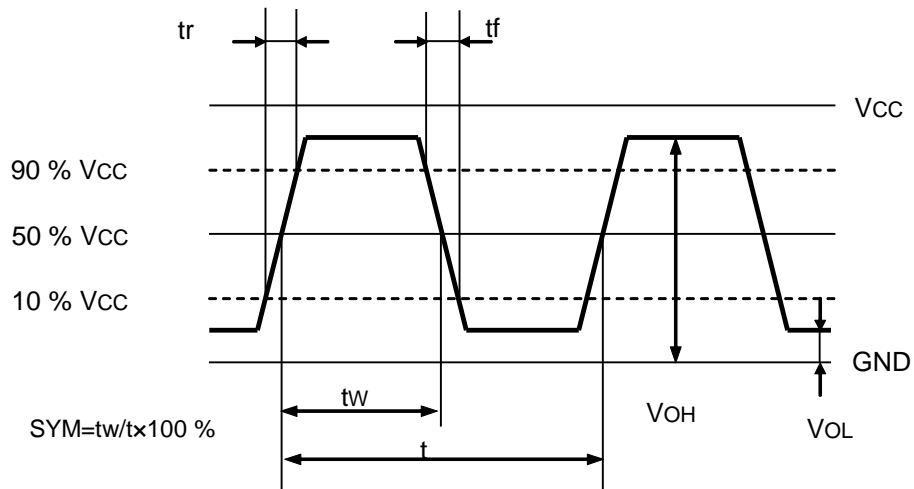

5-2) Output waveform (Clipped sine wave output)

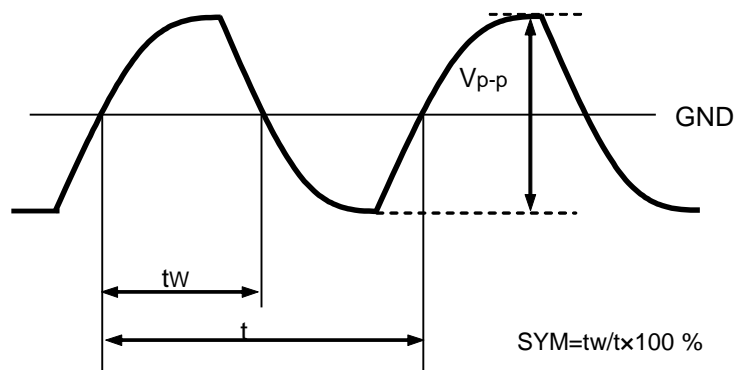

7. Reflow profile (follow to IPC / JEDEC J-STD-020D.1)

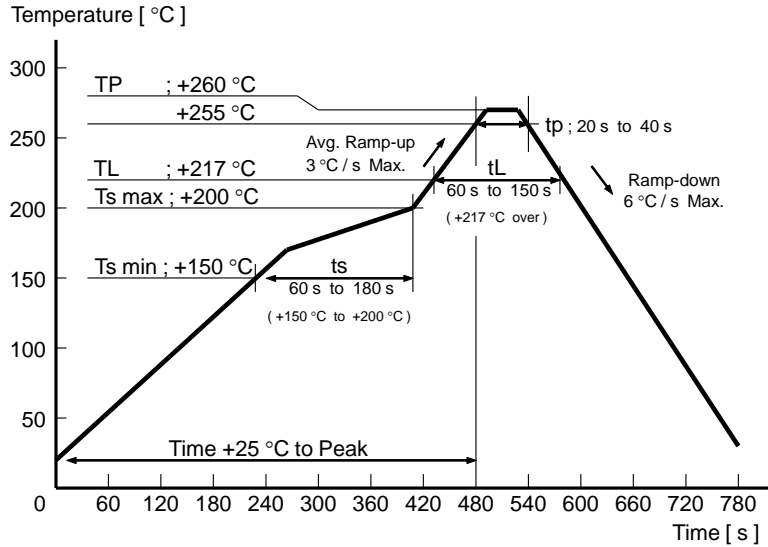

8. Packing information

(8-1) Product number last 2 digits code (00) define Quantity. 1 000 pcs/Reel.

TG5032CFN: X1G005391xxxx00 (Please contact Epson for details of number xxxx)

TG5032SFN: X1G005401xxxx00

(8-2) Taping specification Subject to EIA-481 IEC-60286 JIS C0806

(1) Tape dimensions

Material of the Carrier Tape: PS conduct / Material of the Top Tape: PET

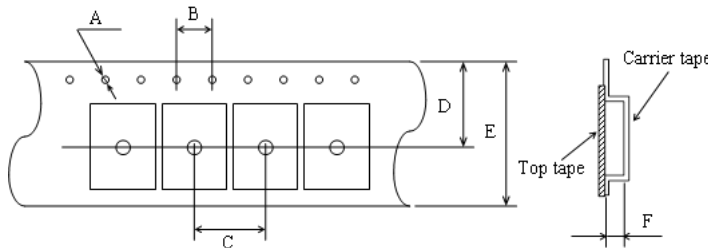

Symbol	A	B	C	D	E	F
Value	φ1.5	4.0	8.0	7.25	12.0	1.7

Unit : mm

(2) Reel dimensions

Material of the reel: Conductive polystyrene

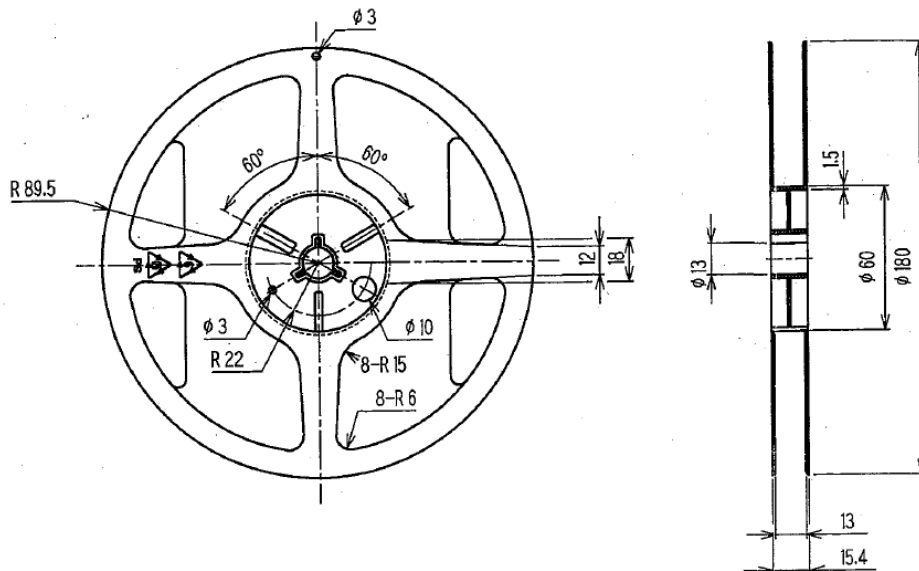

9. Moisture Sensitivity Level, Electro-Static Discharge

(9-1) Moisture Sensitivity Level (MSL)

Parameter	Specifications	Conditions
MSL	LEVEL1	JEDEC J-STD-020D

(9-2) Electro-Static Discharge (ESD)

Parameter	Specifications	Conditions
Human Body Model (HBM)	2 000 V Min	EIAJ ED-4701-1 C111A, 100 pF, 1.5 k Ω , 3 times
Machine Model (MM)	200 V Min	EIAJ ED-4701-1 C111, 200 pF, 0 Ω , 1 time

10. Handling precautions

Prior to using this product, please carefully read the section entitled "Precautions" on our Web site (<https://www5.epsondevice.com/en/information/#precaution>) for instructions on how to handle and use the product properly to ensure optimal performance of the product in your equipment. Before using the product under any conditions other than those specified therein, please consult with us to verify and confirm that the performance of the product will not be negatively affected by use under such conditions.

In addition to the foregoing precautions, in order to avoid the deteriorating performance of the product, we strongly recommend that you DO NOT use the product under ANY of the following conditions:

- (1) Do not expose this product to excessive mechanical shock or vibration.
- (2) This product can be damaged by mechanical shock during the soldering process depending on the equipment used, process conditions, and any impact forces experienced. Always follow appropriate procedures, particularly when changing the assembly process in anyway and be sure to follow applicable process qualification standards before starting production.
- (3) These devices are sensitive to ESD, please use appropriate precautions during handling, assembly, test, shipment, and installation.
- (4) This product contains semiconductor content that should not be exposed to electromagnetic waves.
- (5) The use of ultrasonic technology for cleaning, bonding, etc. can damage the Xtal unit inside this product. Please carefully check for this consideration before using ultrasonic equipment for volume production with this product.
- (6) Noise and ripple on the power supply may have undesirable affects on operation and cause degradation of phase noise characteristics. Evaluate the operation of this device with appropriate power supplies carefully before use.
- (7) When applying power, ensure that the supply voltage increases monotonically for proper operation. On power down, do not reapply power until the supplies, bypass capacitors, and any bulk capacitors are completely discharged since that may cause the unit to malfunction.
- (8) Aging specifications are estimated from environmental reliability tests and expected frequency variation over time. They do not provide a guarantee of aging over the product lifecycle.
- (9) The metal cap on top of the device is directly connected to the GND terminal (pin #2). Take necessary precautions to prevent any conductor not at ground potential from contacting the cap as that could cause a short circuit to GND.
- (10) Do not route any signal lines, supply voltage lines, or GND lines underneath the area where the oscillators are mounted including any internal layers and on the opposite side of the PCB. To avoid any issues due to interference of other signal lines, please take care not to place signal lines near the product as this may have an adverse affect on the performance of the product.
- (11) A bypass capacitor of the recommended value(s) must be connected between the V_{CC} and GND terminals of the product. Whenever possible, mount the capacitor(s) on the same side of the PCB and as close to the product as possible to keep the routing traces short.
- (12) Power supply connections to V_{CC} and GND pins should be routed as thick as possible while keeping the high frequency impedance low in order to get the best performance.
- (13) The use of a filter or similar element in series with the power supply connections to protect from electromagnetic radiation noise may increase the high frequency impedance of the power supply line and may cause the oscillator to not operate properly. Please verify the design to ensure sufficient operational margin prior to use.
- (14) Keep PCB routing from the output terminal(s) to the load as short as possible for best performance.
- (15) Do not short the output to GND as that will damage the product. Always use with an appropriate load resistor connected.
- (16) Product failures during the warranty period only apply when the product is used according to the recommended operating conditions described in the specifications. Products that have been opened for analysis or damaged will not be covered. It is recommended to store and use in normal temperature and humidity environments described in the specifications to ensure frequency accuracy and prevent moisture condensation. If the product is stored for more than one year, please confirm the pin solderability prior to use.
- (17) If the oscillation circuit is exposed to condensation, the frequency may change or oscillation may stop. Do not use in any conditions where condensation occurs.
- (18) Do not store or use the product in an environment where it can be exposed to chemical substances that are corrosive to metal or plastics such as salt water, organic solvents, chemical gasses, etc. Do not use the product when it is exposed to sunlight, dust, corrosive gasses, or other materials for long periods of time.
- (19) When using water-soluble solder flux make sure to completely remove the flux residue after soldering. Pay particular attention when the residues contain active halogens which will negatively affect the product and its performance.