

### NPN Silicon Power Transistor

The transistor is subdivided into four groups, R, Q, P and E, according to its DC current gain.

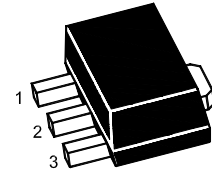

1.Base 2.Collector 3.Emitter  
SOT-89 Plastic Package

#### Absolute Maximum Ratings ( $T_a = 25^\circ\text{C}$ )

Parameter	Symbol	Value	Unit
Collector to Base Voltage	$V_{CBO}$	40	V
Collector to Emitter Voltage	$V_{CEO}$	30	V
Emitter to Base Voltage	$V_{EBO}$	5	V
Collector Current	$I_C$	3	A
Peak Collector Current (t = 10 ms)	$I_{CP}$	7	A
Total power dissipation ( $T_a = 25^\circ\text{C}$ )	$P_{tot}$	1	W
Total power dissipation ( $T_c = 25^\circ\text{C}$ )	$P_{tot}$	10	W
Junction Temperature	$T_j$	150	$^\circ\text{C}$
Storage Temperature Range	$T_{stg}$	- 55 to + 150	$^\circ\text{C}$

#### Characteristics at $T_a = 25^\circ\text{C}$

Parameter	Symbol	Min.	Typ.	Max.	Unit
DC Current Gain at $V_{CE} = 2\text{ V}$ , $I_C = 20\text{ mA}$ at $V_{CE} = 2\text{ V}$ , $I_C = 1\text{ A}$ Current Gain Group	R	30	-	-	-
	Q	60	-	120	-
	P	100	-	200	-
	E	160	-	320	-
			200	-	400
Collector Base Cutoff Current at $V_{CB} = 30\text{ V}$	$I_{CBO}$	-	-	1	$\mu\text{A}$
Emitter Base Cutoff Current at $V_{EB} = 3\text{ V}$	$I_{EBO}$	-	-	1	$\mu\text{A}$
Collector Emitter Saturation Voltage at $I_C = 2\text{ A}$ , $I_B = 0.2\text{ A}$	$V_{CE(sat)}$	-	-	0.5	V
Base Emitter Saturation Voltage at $I_C = 2\text{ A}$ , $I_B = 0.2\text{ A}$	$V_{BE(sat)}$	-	-	2	V
Gain Bandwidth Product at $V_{CE} = 5\text{ V}$ , $I_C = 0.1\text{ A}$	$f_T$	-	90	-	MHz
Output Capacitance at $V_{CB} = 10\text{ V}$ , $f = 1\text{ MHz}$	$C_{ob}$	-	45	-	pF

电话: 0755-82568882    82568883

邮箱: [idchip@indreamchip.com](mailto:idchip@indreamchip.com)

传真: 0755-82568886

网址: [www.idchip.cn](http://www.idchip.cn)

公司地址: 深圳市福田区滨河大道联合广场 A 座 1308

TYPICAL CHARACTERISTICS (Ta=25°C)

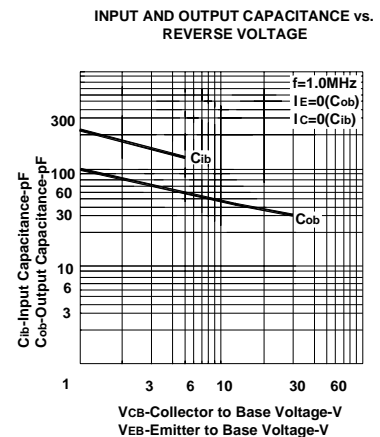
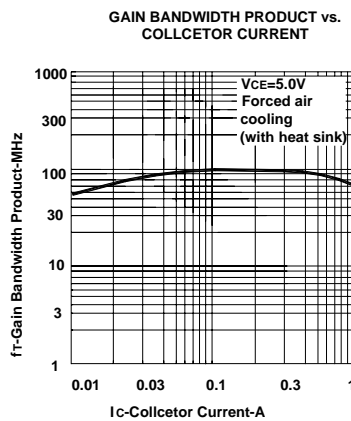
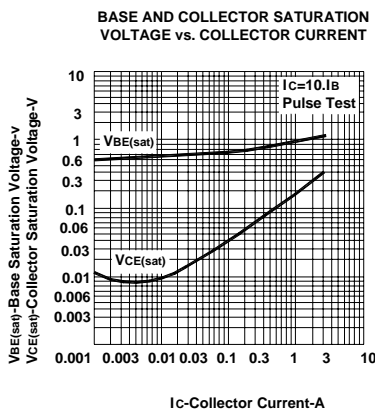
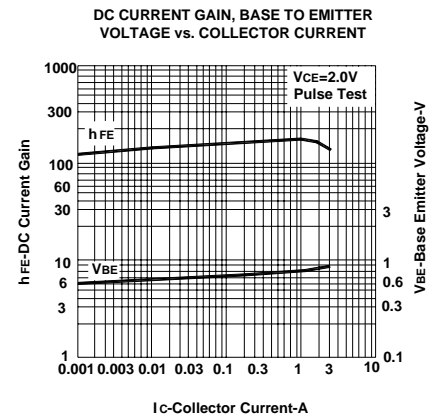
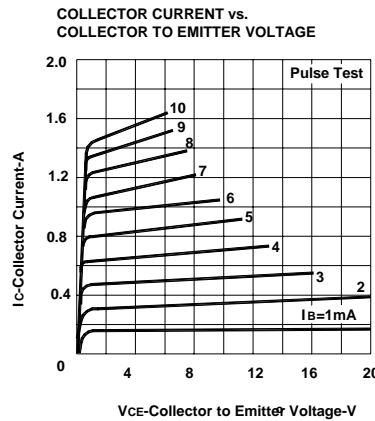
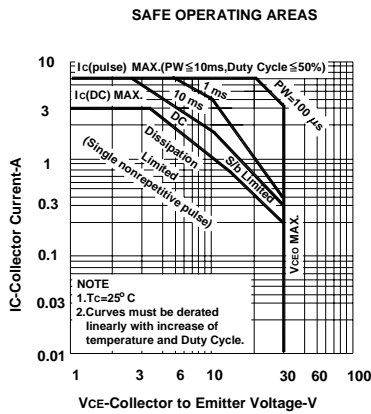
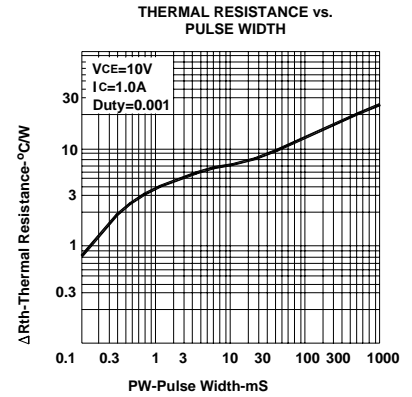
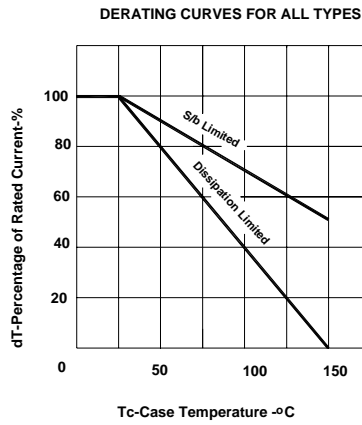
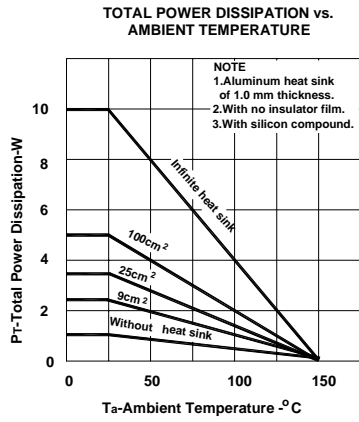

电话: 0755-82568882 82568883

传真: 0755-82568886

公司地址: 深圳市福田区滨河大道联合广场 A 座 1308

邮箱: [idchip@indreamchip.com](mailto:idchip@indreamchip.com)

网址: [www.idchip.cn](http://www.idchip.cn)

## SOT-89 PACKAGE OUTLINE

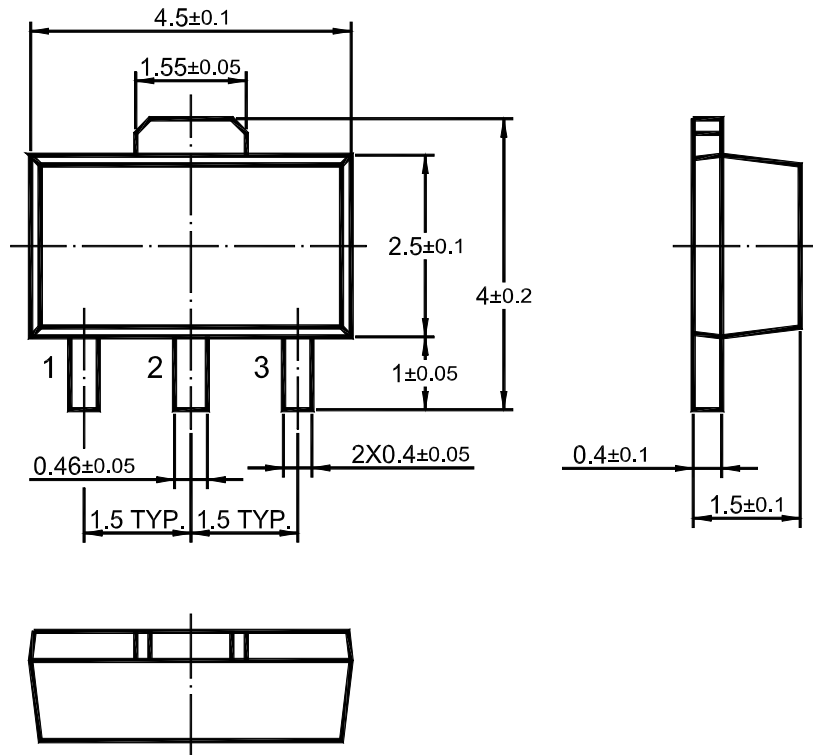

Dimensions in mm

电话: 0755-82568882 82568883

邮箱: [idchip@indreamchip.com](mailto:idchip@indreamchip.com)

传真: 0755-82568886

网址: [www.idchip.cn](http://www.idchip.cn)

公司地址: 深圳市福田区滨河大道联合广场 A 座 1308