

# NCP1595, NCP1595A, NCP1595C

## Buck Regulator- Synchronous

### 1 MHz, 1.5 A

The NCP1595/A/C family are fixed 1 MHz, high-output-current, synchronous PWM converters that integrate a low-resistance, high-side P-channel MOSFET and a low-side N-channel MOSFET. The NCP1595/A/C utilizes current mode control to provide fast transient response and excellent loop stability. It regulates input voltages from 4.0 V to 5.5 V down to an output voltage as low as 0.8 V and is able to supply up to 1.5 A.

The NCP1595/A/C includes an internally fixed switching frequency ( $F_{sw}$ ), and an internal soft-start to limit inrush currents. Using the EN pin, shutdown supply current is reduced to 3  $\mu$ A maximum.

Other features include cycle-by-cycle current limiting, short-circuit protection and thermal shutdown.

#### Features

- Input Voltage Range: from 4.0 V to 5.5 V
- Internal 140 m $\Omega$  High-Side Switching P-Channel MOSFET and 90 m $\Omega$  Low-Side N-Channel MOSFET
- Fixed 1 MHz Switching Frequency
- Cycle-by-Cycle Current Limiting
- Overtemperature Protection
- Internal Soft-Start
- Diode Emulation During Light Load (Disabled for NCP1595C)
- Hiccup Mode Short-Circuit Protection
- Start-up with Pre-Biased Output Load
- Adjustable Output Voltage Down to 0.8 V
- These are Pb-Free Devices

#### Applications

- DSP Power
- Hard Disk Drivers
- Computer Peripherals
- Home Audio
- Set-Top Boxes
- Networking Equipment
- LCD TV
- Wireless and DSL/Cable Modem
- USB Power Devices



**ON Semiconductor®**

<http://onsemi.com>



1  
**DFN6**  
**CASE 506AH**

#### MARKING DIAGRAM

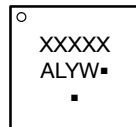

XXXXX = N1595, 1595A, 1595C  
A = Assembly Location  
L = Wafer Lot  
Y = Year  
W = Work Week  
▪ = Pb-Free Package

(Note: Microdot may be in either location)

#### PIN CONNECTIONS

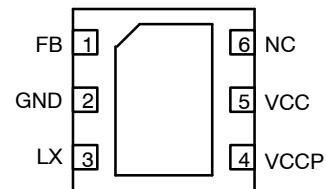

NCP1595/NCP1595C

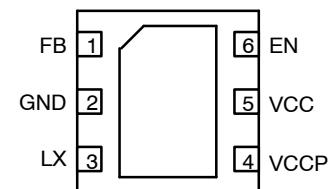

NCP1595A

#### ORDERING INFORMATION

| Device        | Package           | Shipping†          |
|---------------|-------------------|--------------------|
| NCP1595MNR2G  | DFN6<br>(Pb-Free) | 3000 / Tape & Reel |
| NCP1595MNT2G  |                   |                    |
| NCP1595AMNR2G |                   |                    |
| NCP1595AMNTWG |                   |                    |
| NCP1595CMNTWG |                   |                    |

†For information on tape and reel specifications, including part orientation and tape sizes, please refer to our Tape and Reel Packaging Specifications Brochure, BRD8011/D.

# NCP1595, NCP1595A, NCP1595C

## BLOCK DIAGRAM

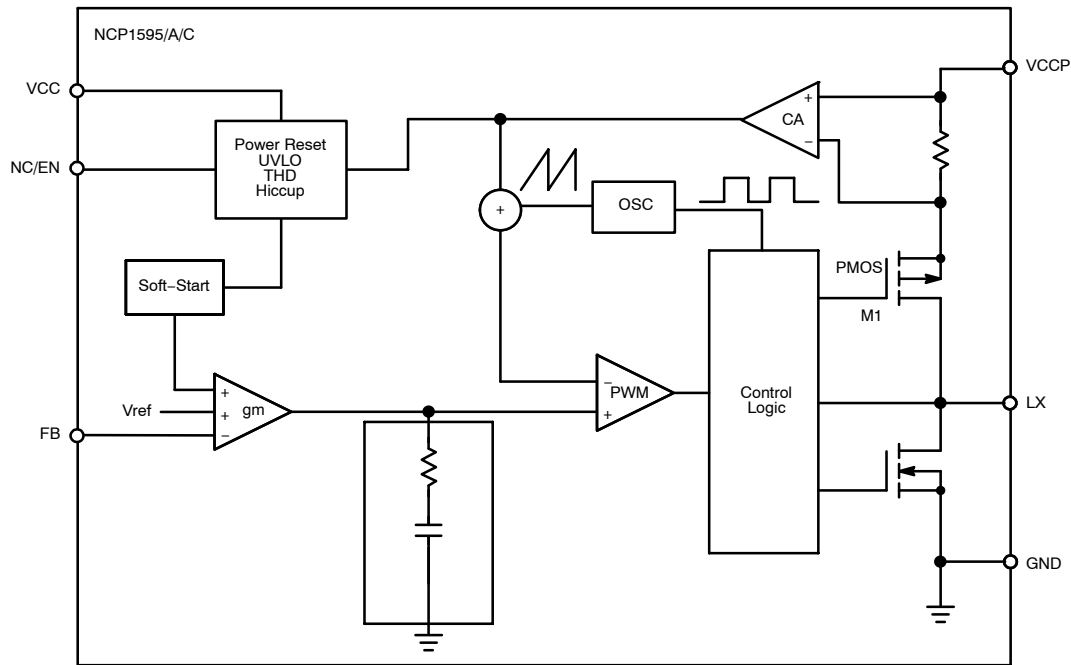

Figure 1. Block Diagram

### PIN DESCRIPTIONS

| Pin No | Symbol           | Description   |
|--------|------------------|---|
| 1      | FB               | Feedback input pin of the Error Amplifier. Connect a resistor divider from the converter's output voltage to this pin to set the converter's output voltage.  |
| 2      | GND              | Ground pin. Connect to thermal pad.   |
| 3      | LX               | The drains of the internal MOSFETs. The output inductor should be connected to this pin.  |
| 4      | V <sub>CCP</sub> | Power input for the power stage   |
| 5      | V <sub>CC</sub>  | Input supply pin for internal bias circuitry. A 0.1 $\mu$ F ceramic bypass capacitor is preferred to connect to this pin.   |
| 6      | NC               | No connection for NCP1595 or NCP1595C   |
|        | EN               | Logic input to enable the part. Logic high to turn on the part and logic low to shut off the part. An internal pullup forces the part into an enable state when no external bias is present on the pin. For NCP1595A only |
| EP     | PAD              | Exposed pad of the package provides both electrical contact to the ground and good thermal contact to the PCB. This pad must be soldered to the PCB for proper operation.   |

# NCP1595, NCP1595A, NCP1595C

## APPLICATION CIRCUIT

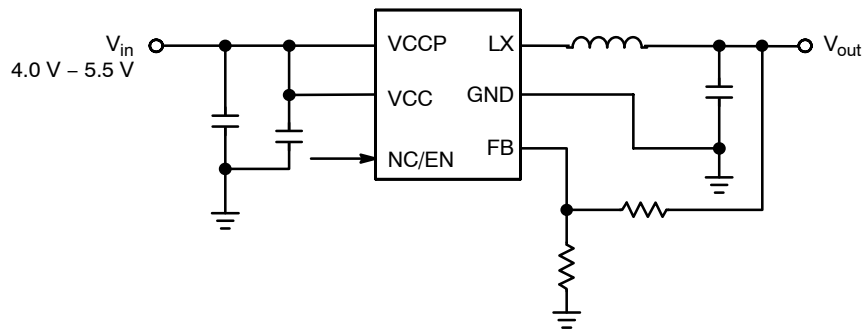

Figure 2. NCP1595/A/C

### ABSOLUTE MAXIMUM RATINGS

| Rating                                      | Symbol          | Value  | Unit |
|---|-----------------|--|------|
| Power Supply Pin (Pin 4, 5) to GND          | $V_{in}$        | 6.5<br>-0.3 (DC)<br>-1.0 ( $t < 100$ ns)   | V    |
| LX to GND                                   | LX              | $V_{in} + 0.7$<br>$V_{in} + 1.0$ ( $t < 20$ ns)<br>-0.7 (DC)<br>-5.0 ( $t < 100$ ns) | V    |
| All other pins                              |                 | 6.0<br>-0.3 (DC)<br>-1.0 ( $t < 100$ ns)   | V    |
| Operating Temperature Range                 | $T_A$           | -40 to +125  | °C   |
| Junction Temperature                        | $T_J$           | -40 to +150  | °C   |
| Storage Temperature Range                   | $T_S$           | -55 to +150  | °C   |
| Thermal Resistance Junction-to-Air (Note 1) | $R_{\theta JA}$ | 68.5   | °C/W |

Stresses exceeding those listed in the Maximum Ratings table may damage the device. If any of these limits are exceeded, device functionality should not be assumed, damage may occur and reliability may be affected.

1.  $R_{\theta JA}$  measured on approximately 1x1 inch sq. of 1 oz. Copper.

# NCP1595, NCP1595A, NCP1595C

## ELECTRICAL CHARACTERISTICS

( $V_{in} = 4.0\text{ V} - 5.5\text{ V}$ ,  $V_{out} = 1.2\text{ V}$ ,  $T_J = +25^\circ\text{C}$  for typical value; For NCP1595, NCP1595A:  $-40^\circ\text{C} < T_A < 125^\circ\text{C}$ ; For NCP1595C:  $-40^\circ\text{C} < T_A < 85^\circ\text{C}$  for min/max values unless noted otherwise)

| Parameter                                 | Symbol       | Test Conditions  | Min | Typ | Max | Unit          |
|---|--------------|--|-----|-----|-----|---------------|
| $V_{in}$ Input Voltage Range (Note 2)     | $V_{in}$     |  | 4.0 |     | 5.5 | V             |
| $V_{CC}$ UVLO Threshold                   |              |  | 3.2 | 3.5 | 3.8 | V             |
| UVLO Hysteresis                           |              |  |     | 335 |     | mV            |
| $V_{CC}$ Quiescent Current                | $I_{inVCC}$  | $V_{in} = 5\text{ V}, V_{FB} = 1.5\text{ V}$ ,<br>(No Switching) |     | 1.7 | 2.0 | mA            |
| $V_{CCP}$ Quiescent Current               | $I_{inVCCP}$ | $V_{in} = 5\text{ V}, V_{FB} = 1.5\text{ V}$ ,<br>(No Switching) |     | 25  |     | $\mu\text{A}$ |
| $V_{in}$ Shutdown Supply Current (Note 3) | $I_{QSHDN}$  | (NCP1595A), $EN = 0\text{ V}$                                    |     | 1.8 | 3.0 | $\mu\text{A}$ |

## FEEDBACK VOLTAGE

|   |          |  |       |       |       |     |
|---|----------|--|-------|-------|-------|-----|
| Reference Voltage                         | $V_{FB}$ |  | 0.788 | 0.800 | 0.812 | V   |
| Feedback Input Bias Current (Note 2)      | $I_{FB}$ | $V_{FB} = 0.8\text{ V}$                  |       | 10    | 100   | nA  |
| Feedback Voltage Line Regulation (Note 3) |          | $V_{in} = 4.0\text{ V to } 5.5\text{ V}$ |       | 0.06  |       | %/V |

## PWM

|  |  |  |    |    |  |    |
|--|--|--|----|----|--|----|
| Maximum Controllable Duty Cycle (regulating) |  |  | 82 | 85 |  | %  |
| Minimum Controllable ON Time (Note 3)        |  |  |    | 50 |  | ns |

## PULSE-BY-PULSE CURRENT LIMIT

|   |             |  |     |     |     |   |
|---|-------------|--|-----|-----|-----|---|
| Pulse-by-Pulse Current Limit (Regulation) | $I_{LIM}$   |  | 2.7 | 3.9 | 4.3 | A |
| Pulse-by-Pulse Current Limit (Soft-Start) | $I_{LIMSS}$ |  | 4.0 | 5.3 | 6.1 | A |

## OSCILLATOR

|                      |          |  |      |     |      |     |
|----------------------|----------|--|------|-----|------|-----|
| Oscillator Frequency | $F_{SW}$ |  | 0.87 | 1.0 | 1.13 | MHz |
|----------------------|----------|--|------|-----|------|-----|

## MOSFET

|   |                |   |  |     |     |                  |
|---|----------------|---|--|-----|-----|------------------|
| High Side MOSFET ON Resistance (Note 2) | $R_{DS(on)HS}$ | $I_{DS} = 100\text{ mA}, V_{GS} = 5\text{ V}$ |  | 140 | 200 | $\text{m}\Omega$ |
| High Side MOSFET Leakage (Note 3)       |                | $V_{EN} = 0\text{ V}, V_{SW} = 0\text{ V}$    |  |     | 10  | $\mu\text{A}$    |
| Low Side MOSFET ON Resistance (Note 2)  | $R_{DS(on)LS}$ | $I_{DS} = 100\text{ mA}, V_{GS} = 5\text{ V}$ |  | 90  | 125 | $\text{m}\Omega$ |
| Low Side MOSFET Leakage (Note 3)        |                | $V_{EN} = 0\text{ V}, V_{SW} = 5\text{ V}$    |  |     | 10  | $\mu\text{A}$    |

## ENABLE (NCP1595A)

|                   |      |            |     |     |     |               |
|-------------------|------|------------|-----|-----|-----|---------------|
| EN HI Threshold   | ENHI | (NCP1595A) | 1.4 |     |     | V             |
| EN LO Threshold   | ENLO | (NCP1595A) |     |     | 0.4 | V             |
| EN Hysteresis     |      | (NCP1595A) |     | 200 |     | mV            |
| EN Pullup Current |      | (NCP1595A) |     | 1.4 | 3.0 | $\mu\text{A}$ |

## SOFT-START

|                               |          |                         |  |     |  |    |
|-------------------------------|----------|-------------------------|--|-----|--|----|
| Soft-Start Ramp Time (Note 3) | $t_{SS}$ | $F_{SW} = 1\text{ MHz}$ |  | 1.0 |  | ms |
| Hiccup Timer (Note 3)         |          |                         |  | 2.0 |  | ms |

## THERMAL SHUTDOWN

|                                      |  |  |  |     |  |                  |
|--------------------------------------|--|--|--|-----|--|------------------|
| Thermal Shutdown Threshold (Note 3)  |  |  |  | 185 |  | $^\circ\text{C}$ |
| Thermal Shutdown Hysteresis (Note 3) |  |  |  | 40  |  | $^\circ\text{C}$ |

2. Guaranteed by characterization. Not production tested.

3. Guaranteed by design. Not production tested.

Product parametric performance is indicated in the Electrical Characteristics for the listed test conditions, unless otherwise noted. Product performance may not be indicated by the Electrical Characteristics if operated under different conditions.

# NCP1595, NCP1595A, NCP1595C

## TYPICAL OPERATING CHARACTERISTICS

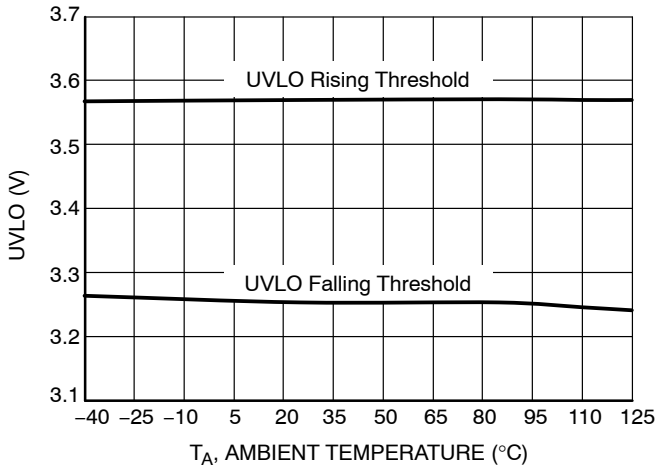

**Figure 3. Undervoltage Lockout vs. Temperature**

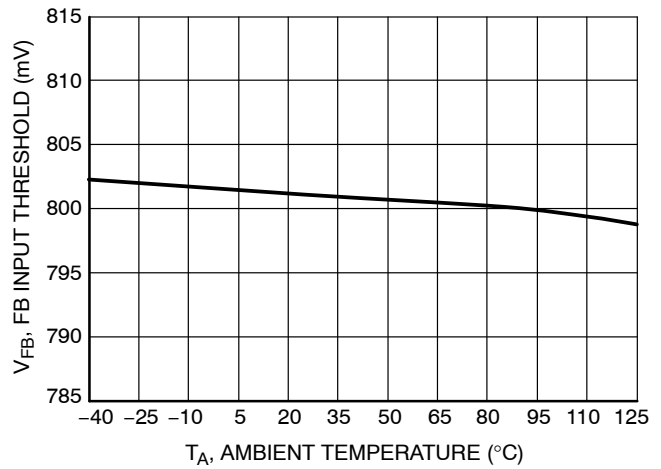

**Figure 4. Feedback Input Threshold vs. Temperature**

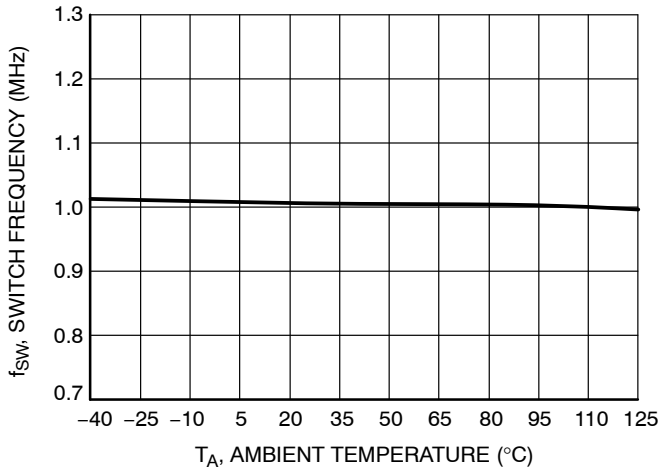

**Figure 5. Switching Frequency vs. Temperature**

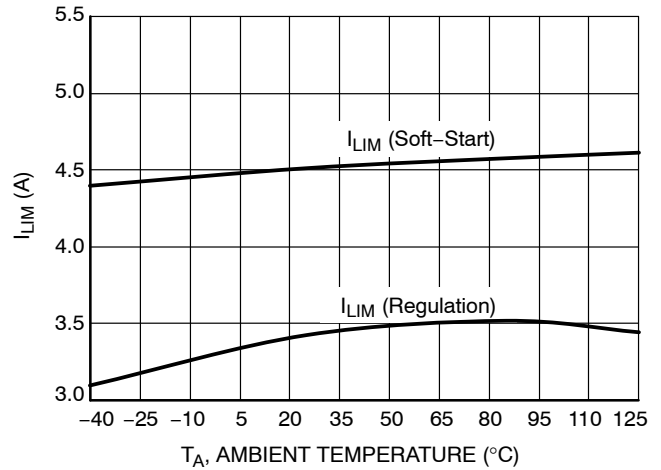

**Figure 6. Current Limit vs. Temperature**

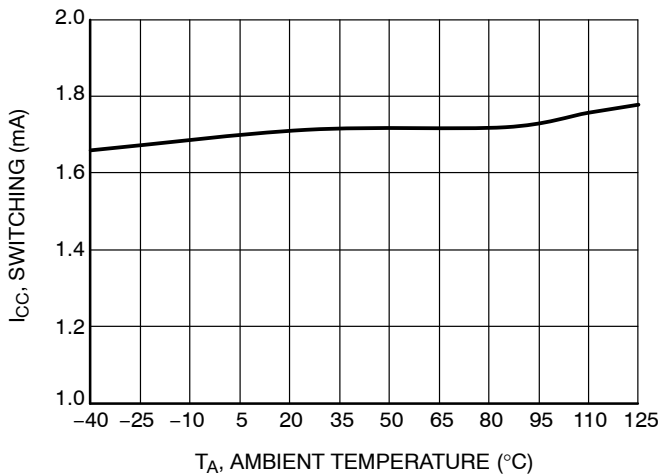

**Figure 7. Quiescent Current Into V<sub>CC</sub> vs. Temperature**

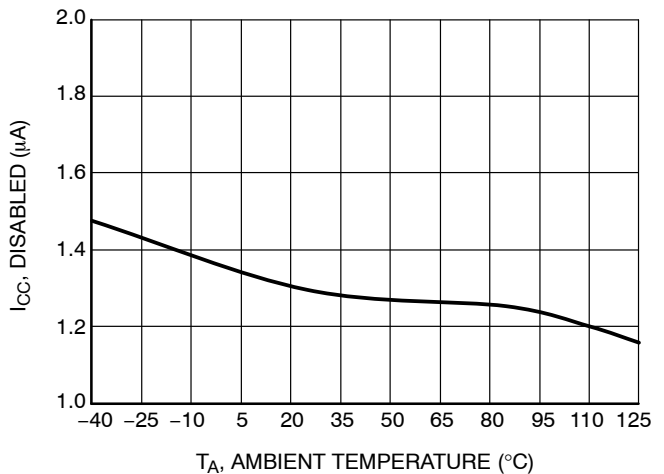

**Figure 8. Quiescent Current Into V<sub>CC</sub> vs. Temperature**

# NCP1595, NCP1595A, NCP1595C

## TYPICAL OPERATING CHARACTERISTICS

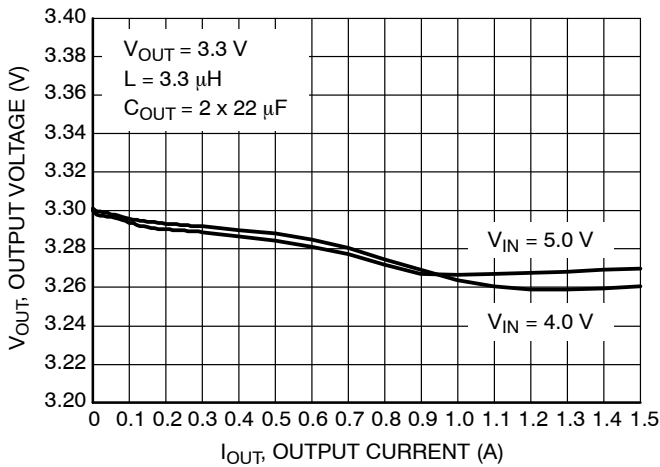

Figure 9. Load Regulation for  $V_{OUT} = 3.3\text{ V}$

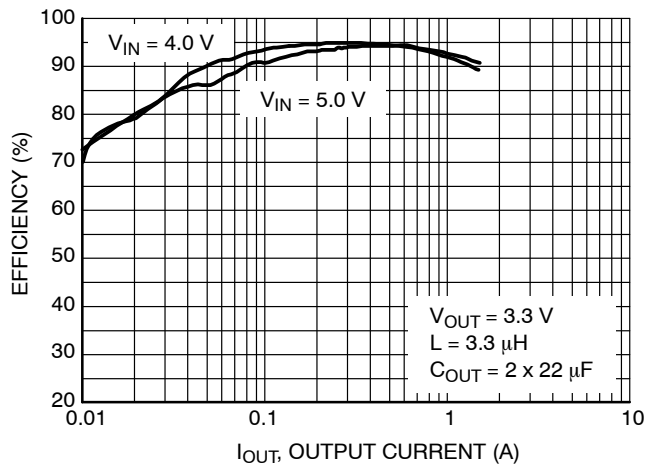

Figure 10. Efficiency vs. Output Current for  $V_{OUT} = 3.3\text{ V}$

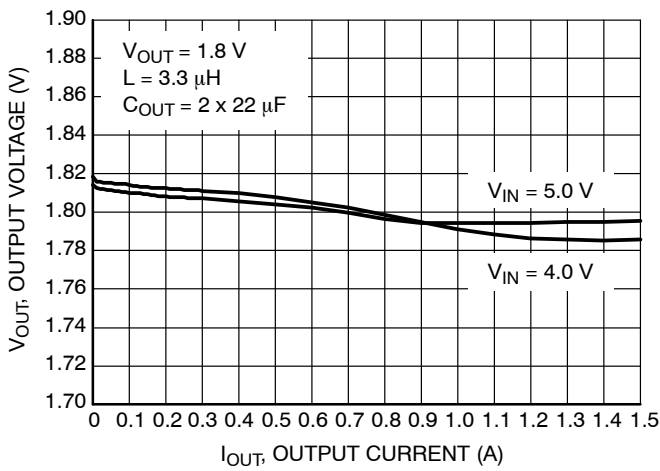

Figure 11. Load Regulation for  $V_{OUT} = 1.8\text{ V}$

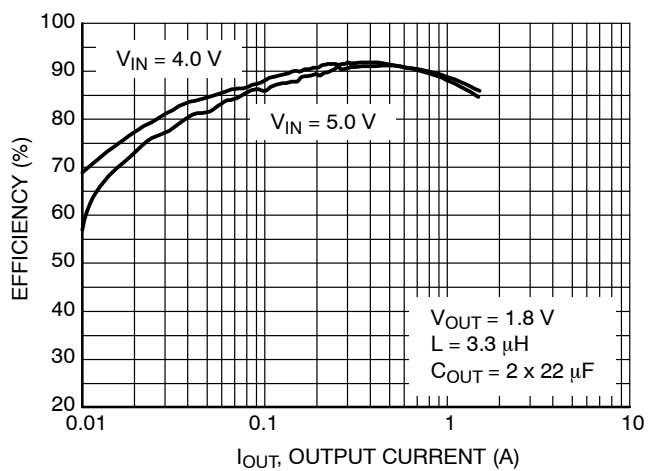

Figure 12. Efficiency vs. Output Current for  $V_{OUT} = 1.8\text{ V}$

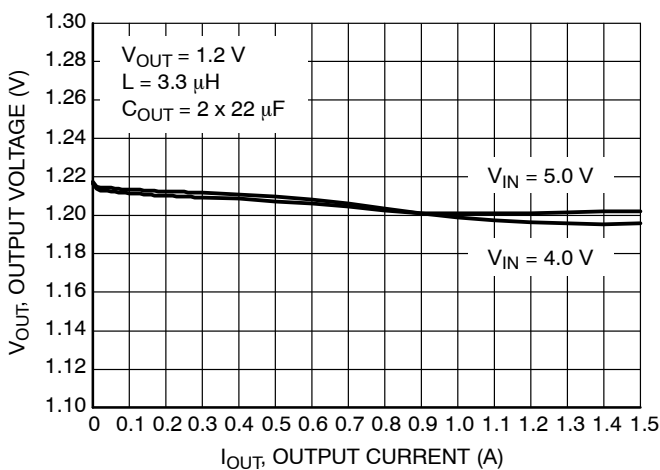

Figure 13. Load Regulation for  $V_{OUT} = 1.2\text{ V}$

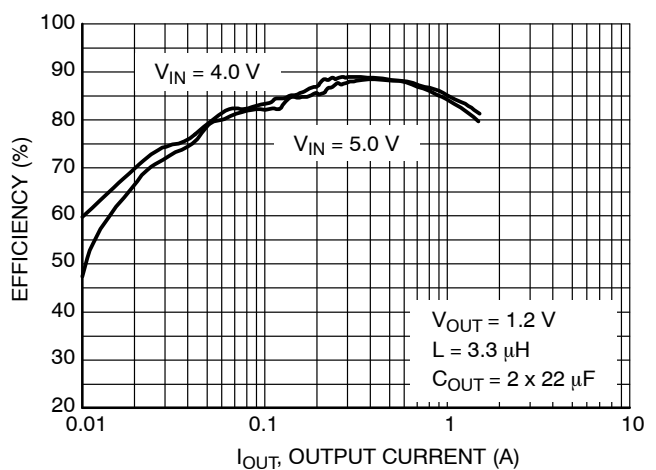

Figure 14. Efficiency vs. Output Current for  $V_{OUT} = 1.2\text{ V}$

# NCP1595, NCP1595A, NCP1595C



( $V_{IN} = 5\text{ V}$ ,  $I_{LOAD} = 100\text{ mA}$ ,  $L = 3.3\text{ }\mu\text{H}$ ,  $C_{OUT} = 2 \times 22\text{ }\mu\text{F}$ )  
 Upper Trace:  $L_X$  Pin Switching Waveform, 2 V/div  
 Middle Trace: Output Ripple Voltage, 20 mV/div  
 Lower Trace: Inductor Current, 1 A/div  
 Time Scale: 1.0  $\mu\text{s}/\text{div}$

**Figure 15. DCM Switching Waveform for  $V_{OUT} = 3.3\text{ V}$**

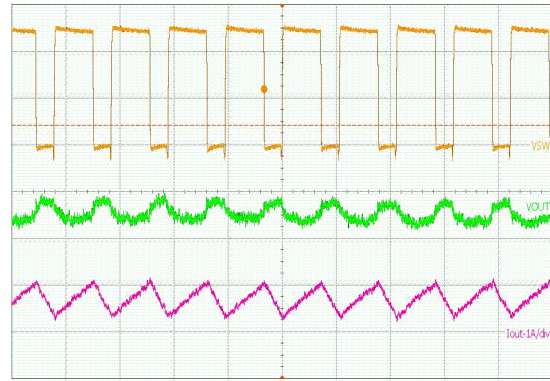

( $V_{IN} = 5\text{ V}$ ,  $I_{LOAD} = 700\text{ mA}$ ,  $L = 3.3\text{ }\mu\text{H}$ ,  $C_{OUT} = 2 \times 22\text{ }\mu\text{F}$ )  
 Upper Trace:  $L_X$  Pin Switching Waveform, 2 V/div  
 Middle Trace: Output Ripple Voltage, 20 mV/div  
 Lower Trace: Inductor Current, 1 A/div  
 Time Scale: 1.0  $\mu\text{s}/\text{div}$

**Figure 16. CCM Switching Waveform for  $V_{OUT} = 3.3\text{ V}$**



( $V_{IN} = 5\text{ V}$ ,  $I_{LOAD} = 100\text{ mA}$ ,  $L = 3.3\text{ }\mu\text{H}$ ,  $C_{OUT} = 2 \times 22\text{ }\mu\text{F}$ )  
 Upper Trace:  $L_X$  Pin Switching Waveform, 2 V/div  
 Middle Trace: Output Ripple Voltage, 20 mV/div  
 Lower Trace: Inductor Current, 200 mA/div  
 Time Scale: 1.0  $\mu\text{s}/\text{div}$

**Figure 17. DCM Switching Waveform for  $V_{OUT} = 1.2\text{ V}$**

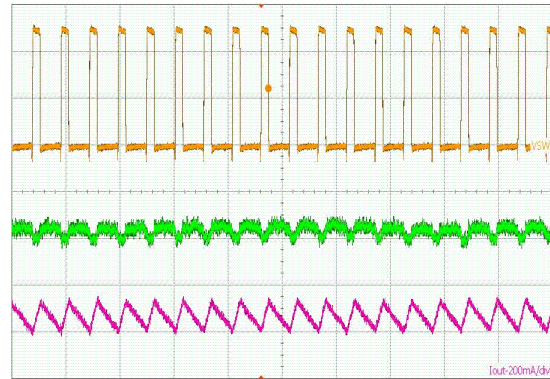

( $V_{IN} = 5\text{ V}$ ,  $I_{LOAD} = 400\text{ mA}$ ,  $L = 3.3\text{ }\mu\text{H}$ ,  $C_{OUT} = 2 \times 22\text{ }\mu\text{F}$ )  
 Upper Trace:  $L_X$  Pin Switching Waveform, 2 V/div  
 Middle Trace: Output Ripple Voltage, 20 mV/div  
 Lower Trace: Inductor Current, 1 A/div  
 Time Scale: 1.0  $\mu\text{s}/\text{div}$

**Figure 18. CCM Switching Waveform for  $V_{OUT} = 1.2\text{ V}$**



( $V_{IN} = 5\text{ V}$ ,  $I_{LOAD} = 100\text{ mA}$ ,  $L = 3.3\text{ }\mu\text{H}$ ,  $C_{OUT} = 2 \times 22\text{ }\mu\text{F}$ )  
 Upper Trace: EN Pin Voltage, 2 V/div  
 Middle Trace: Output Voltage, 1 V/div  
 Lower Trace: Inductor Current, 100 mA/div  
 Time Scale: 500  $\mu\text{s}/\text{div}$

**Figure 19. Soft-Start Waveforms for  $V_{OUT} = 3.3\text{ V}$**

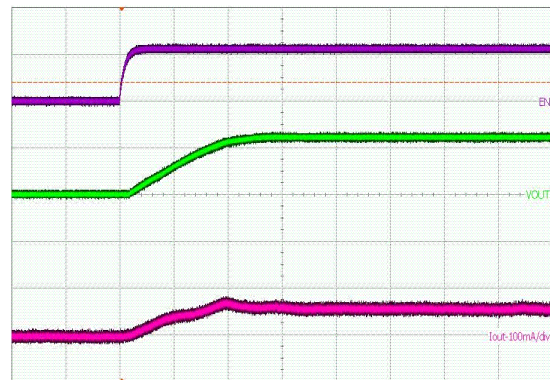

( $V_{IN} = 5\text{ V}$ ,  $I_{LOAD} = 100\text{ mA}$ ,  $L = 3.3\text{ }\mu\text{H}$ ,  $C_{OUT} = 2 \times 22\text{ }\mu\text{F}$ )  
 Upper Trace: EN Pin Voltage, 2 V/div  
 Middle Trace: Output Voltage, 1 V/div  
 Lower Trace: Inductor Current, 100 mA/div  
 Time Scale: 500  $\mu\text{s}/\text{div}$

**Figure 20. Soft-Start Waveforms for  $V_{OUT} = 1.2\text{ V}$**

# NCP1595, NCP1595A, NCP1595C

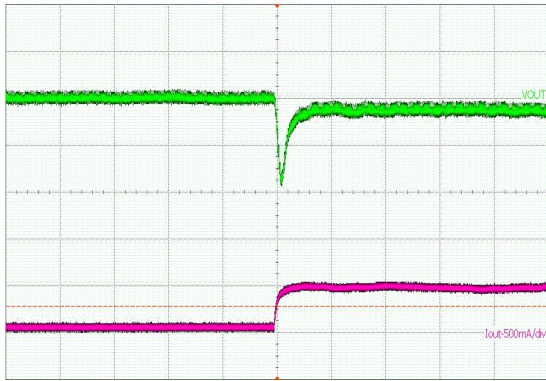

( $V_{IN} = 5\text{ V}$ ,  $I_{LOAD} = 100\text{ mA}$ ,  $L = 3.3\text{ }\mu\text{H}$ ,  $C_{OUT} = 2 \times 22\text{ }\mu\text{F}$ )  
Upper Trace: Output Dynamic Voltage, 100 mV/div  
Lower Trace: Output Current, 500 mA/div  
Time Scale: 200  $\mu\text{s}/\text{div}$

**Figure 21. Transient Response for  $V_{OUT} = 3.3\text{ V}$**

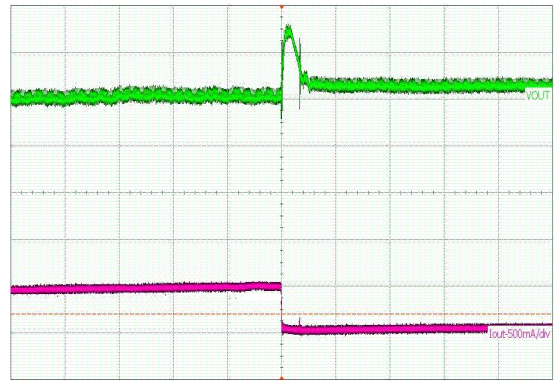

( $V_{IN} = 5\text{ V}$ ,  $I_{LOAD} = 100\text{ mA}$ ,  $L = 3.3\text{ }\mu\text{H}$ ,  $C_{OUT} = 2 \times 22\text{ }\mu\text{F}$ )  
Upper Trace: Output Dynamic Voltage, 100 mV/div  
Lower Trace: Output Current, 500 mA/div  
Time Scale: 200  $\mu\text{s}/\text{div}$

**Figure 22. Transient Response for  $V_{OUT} = 3.3\text{ V}$**

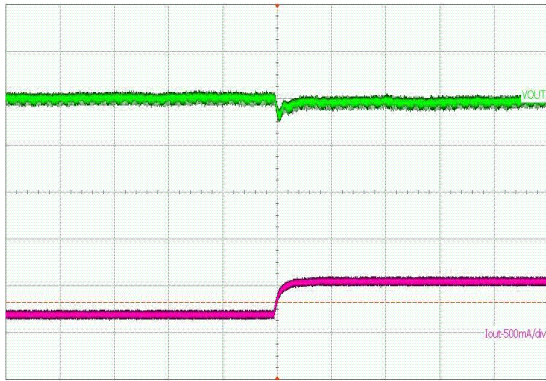

( $V_{IN} = 5\text{ V}$ ,  $I_{LOAD} = 100\text{ mA}$ ,  $L = 3.3\text{ H}$ ,  $C_{OUT} = 2 \times 22\text{ }\mu\text{F}$ )  
Upper Trace: Output Dynamic Voltage, 100 mV/div  
Lower Trace: Output Current, 500 mA/div  
Time Scale: 200  $\mu\text{s}/\text{div}$

**Figure 23. Transient Response for  $V_{OUT} = 1.2\text{ V}$**

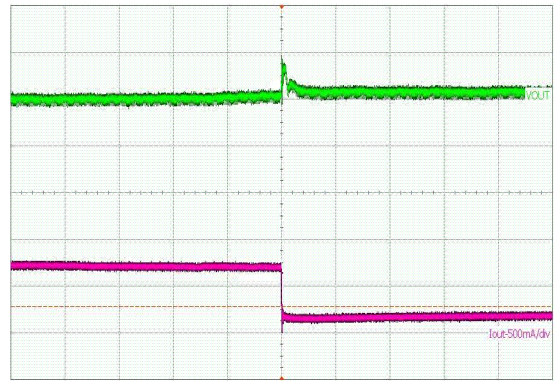

( $V_{IN} = 5\text{ V}$ ,  $I_{LOAD} = 100\text{ mA}$ ,  $L = 3.3\text{ H}$ ,  $C_{OUT} = 2 \times 22\text{ }\mu\text{F}$ )  
Upper Trace: Output Dynamic Voltage, 100 mV/div  
Lower Trace: Output Current, 500 mA/div  
Time Scale: 200  $\mu\text{s}/\text{div}$

**Figure 24. Transient Response for  $V_{OUT} = 1.2\text{ V}$**



# NCP1595, NCP1595A, NCP1595C

## DETAILED DESCRIPTION

### Overview

The NCP1595/A/C is a synchronous PWM controller that incorporates all the control and protection circuitry necessary to satisfy a wide range of applications. The NCP1595/A/C employs current mode control to provide fast transient response, simple compensation, and excellent stability. The features of the NCP1595/A/C include a precision reference, fixed 1 MHz switching frequency, a transconductance error amplifier, an integrated high-side P-channel MOSFET and low-side N-channel MOSFET, internal soft-start, and very low shutdown current. The protection features of the NCP1595/A/C include internal soft-start, pulse-by-pulse current limit, and thermal shutdown.

### Reference Voltage

The NCP1595/A/C incorporates an internal reference that allows output voltages as low as 0.8 V. The tolerance of the internal reference is guaranteed over the entire operating temperature range of the controller. The reference voltage is trimmed using a test configuration that accounts for error amplifier offset and bias currents.

### Oscillator Frequency

A fixed precision oscillator is provided. The oscillator frequency range is 1 MHz with  $\pm 13\%$  variation.

### Transconductance Error Amplifier

The transconductance error amplifier's primary function is to regulate the converter's output voltage using a resistor divider connected from the converter's output to the FB pin of the controller, as shown in the applications Schematic. If a Fault occurs, the amplifier's output is immediately pulled to GND and PWM switching is inhibited.

### Internal Soft-Start

To limit the startup inrush current, an internal soft start circuit is used to ramp up the reference voltage from 0 V to its final value linearly. The internal soft start time is 1 ms typically.

### Output MOSFETs

The NCP1595/A/C includes low  $R_{DS(on)}$ , both high-side P-channel and low-side N-channel MOSFETs capable of delivering up to 1.5 A of current. When the controller is disabled or during a Fault condition, the controller's output stage is tri-stated by turning OFF both the upper and lower MOSFETs.

### Adaptive Dead Time Gate Driver

In a synchronous buck converter, a certain dead time is required between the low side drive signal and high side drive signal to avoid shoot through. During the dead time, the body diode of the low side FET freewheels the current. The body diode has much higher voltage drop than that of the MOSFET, which reduces the efficiency significantly. The longer the body diode conducts, the lower the efficiency. In NCP1595/A/C, the drivers and MOSFETs are integrated in a single chip. The parasitic inductance is minimized. Adaptive dead time control method is used to prevent the shoot through from happening and minimizing the diode conduction loss at the same time.

### Pulse Width Modulation

A high-speed PWM comparator, capable of pulse widths as low as 50 ns, is included in the NCP1595/A/C. The inverting input of the comparator is connected to the output of the error amplifier. The non-inverting input is connected to the the current sense signal. At the beginning of each PWM cycle, the CLK signal sets the PWM flip-flop and the upper MOSFET is turned ON. When the current sense signal rises above the error amplifier's voltage then the comparator will reset the PWM flip-flop and the upper MOSFET will be turned OFF.

### Current Sense

The NCP1595/A/C monitors the current in the upper MOSFET. The current signal is required by the PWM comparator and the pulse-by-pulse current limiter.

## PROTECTIONS

### Undervoltage Lockout (UVLO)

The under voltage lockout feature prevents the controller from switching when the input voltage is too low to power the internal power supplies and reference. Hysteresis must be incorporated in the UVLO comparator to prevent IxR drops in the wiring or PCB traces from causing ON/OFF cycling of the controller during heavy loading at power up or power down.

### Overcurrent Protection (OCP)

NCP1595/A/C detects high side switch current and then compares to a voltage level representing the overcurrent threshold limit. If the current through the high side FET exceeds the overcurrent threshold limit for seven consecutive switching cycles, overcurrent protection is triggered.

Once the overcurrent protection occurs, hiccup mode engages. First, hiccup mode, turns off both FETs and discharges the internal compensation network at the output of the OTA. Next, the IC waits typically 2 ms and then resets the overcurrent counter. After this reset, the circuit attempts another normal soft-start. During soft-start, the overcurrent protection threshold is increased to prevent false overcurrent detection while charging the output capacitors. Hiccup mode reduces input supply current and power

dissipation during a short circuit. It also allows for much improved system up-time, allowing auto-restart upon removal of a temporary short-circuit.

### Power Save Mode

If the load current decreases, the converter can skip switching and operate with reduced frequency. This minimizes the quiescent current and maintains high efficiency. NCP1595C disables this feature.

### Pre-Bias Startup

In some applications the controller will be required to start switching when it's output capacitors are charged anywhere from slightly above 0 V to just below the regulation voltage. This situation occurs for a number of reasons: the converter's output capacitors may have residual charge on them or the converter's output may be held up by a low current standby power supply. NCP1595/A/C supports pre-bias start up by holding switching off until the soft-start ramp reaches the FB Pin voltage.

### Thermal Shutdown

The NCP1595/A/C protects itself from over heating with an internal thermal monitoring circuit. If the junction temperature exceeds the thermal shutdown threshold both the upper and lower MOSFETs will be shut OFF.

APPLICATION INFORMATION

Programming the Output Voltage

The output voltage is set using a resistive voltage divider from the output voltage to FB pin (see Figure 25). So the output voltage is calculated according to Eq.1.

$$V_{out} = V_{FB} \cdot \frac{R_1 + R_2}{R_2} \quad (\text{eq. 1})$$

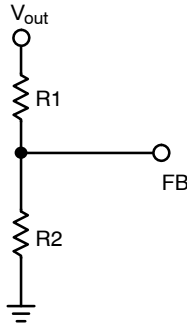

Figure 25. Output divider

Inductor Selection

The inductor is the key component in the switching regulator. The selection of inductor involves trade-offs among size, cost and efficiency. The inductor value is selected according to the equation 2.

$$L = \frac{V_{out}}{f \cdot I_{ripple}} \cdot \left( 1 - \frac{V_{out}}{V_{in(max)}} \right) \quad (\text{eq. 2})$$

Where  $V_{out}$  – the output voltage;  
 $f$  – switching frequency, 1.0 MHz;  
 $I_{ripple}$  – Ripple current, usually it's 20% – 30% of output current;  
 $V_{in(max)}$  – maximum input voltage.

Choose a standard value close to the calculated value to maintain a maximum ripple current within 30% of the maximum load current. If the ripple current exceeds this 30% limit, the next larger value should be selected.

The inductor's RMS current rating must be greater than the maximum load current and its saturation current should be about 30% higher. For robust operation in fault conditions (start-up or short circuit), the saturation current should be high enough. To keep the efficiency high, the series resistance (DCR) should be less than 0.1  $\Omega$ , and the core material should be intended for high frequency applications.

Output Capacitor Selection

The output capacitor acts to smooth the dc output voltage and also provides energy storage. So the major parameter necessary to define the output capacitor is the maximum allowed output voltage ripple of the converter. This ripple is related to capacitance and the ESR. The minimum capacitance required for a certain output ripple can be calculated by Equation 4.

$$C_{OUT(min)} = \frac{I_{ripple}}{8 \cdot f \cdot V_{ripple}} \quad (\text{eq. 3})$$

Where  $V_{ripple}$  is the allowed output voltage ripple.

The required ESR for this amount of ripple can be calculated by equation 5.

$$ESR = \frac{V_{ripple}}{I_{ripple}} \quad (\text{eq. 4})$$

Based on Equation 2 to choose capacitor and check its ESR according to Equation 3. If ESR exceeds the value from Eq.4, multiple capacitors should be used in parallel.

Ceramic capacitor can be used in most of the applications. In addition, both surface mount tantalum and through-hole aluminum electrolytic capacitors can be used as well.

Maximum Output Capacitor

NCP1595/A/C family has internal 1 ms fixed soft-start and overcurrent limit. It limits the maximum allowed output capacitor to startup successfully. The maximum allowed output capacitor can be determined by the equation:

$$C_{out(max)} = \frac{I_{lim(min)} - I_{load(max)} - \frac{\Delta I_{p-p}}{2}}{V_{out}/T_{SS(min)}} \quad (\text{eq. 5})$$

Where  $T_{SS(min)}$  is the minimum soft-start period (1ms);  $\Delta I_{pp}$  is the current ripple.

This is assuming that a constant load is connected. For example, with 3.3 V/2.0 A output and 20% ripple, the max allowed output capacitors is 546  $\mu$ F.

Input Capacitor Selection

The input capacitor can be calculated by Equation 6.

$$C_{in(min)} = I_{out(max)} \cdot D_{max} \cdot \frac{1}{f \cdot V_{in(ripple)}} \quad (\text{eq. 6})$$

Where  $V_{in(ripple)}$  is the required input ripple voltage.

$$D_{max} = \frac{V_{out}}{V_{in(min)}} \text{ is the maximum duty cycle.} \quad (\text{eq. 7})$$

Power Dissipation

The NCP1595/A/C is available in a thermally enhanced 6-pin, DFN. When the die temperature reaches +185°C, the NCP1595/A/C shuts down (see the *Thermal-Overload Protection* section). The power dissipated in the device is the sum of the power dissipated from supply current (PQ), power dissipated due to switching the internal power MOSFET (P<sub>SW</sub>), and the power dissipated due to the RMS current through the internal power MOSFET (PON). The total power dissipated in the package must be limited so the junction temperature does not exceed its absolute maximum rating of +150°C at maximum ambient temperature.

## NCP1595, NCP1595A, NCP1595C

Calculate the power lost in the NCP1595/A/C using the following equations:

### 1. High side MOSFET

The conduction loss in the top switch is:

$$P_{HSON} = I_{RMS\_HSFET}^2 \times R_{DS(on)HS} \quad (\text{eq. 8})$$

Where:

$$I_{RMS\_FET} = \sqrt{\left(I_{out}^2 + \frac{\Delta I_{PP}^2}{12}\right) \times D} \quad (\text{eq. 9})$$

$\Delta I_{PP}$  is the peak-to-peak inductor current ripple.

The power lost due to switching the internal power high side MOSFET is:

$$P_{HSSW} = \frac{V_{in} \cdot I_{out} \cdot (t_r + t_f) \cdot f_{SW}}{2} \quad (\text{eq. 10})$$

$t_r$  and  $t_f$  are the rise and fall times of the internal power MOSFET measured at SW node.

### 2. Low side MOSFET

The power dissipated in the top switch is:

$$P_{LSON} = I_{RMS\_LSFET}^2 \cdot R_{DS(on)LS} \quad (\text{eq. 11})$$

Where:

$$I_{RMS\_LSFET} = \sqrt{\left(I_{out}^2 + \frac{\Delta I_{PP}^2}{12}\right) \cdot (1 - D)} \quad (\text{eq. 12})$$

$\Delta I_{PP}$  is the peak-to-peak inductor current ripple.

The switching loss for the low side MOSFET can be ignored.

The power lost due to the quiescent current ( $I_Q$ ) of the device is:

$$P_Q = V_{in} \cdot I_Q \quad (\text{eq. 13})$$

$I_Q$  is the switching quiescent current of the NCP1595/A/C.

$$P_{TOTAL} = P_{HSON} + P_{HSSW} + P_{LSON} + P_Q \quad (\text{eq. 14})$$

Calculate the temperature rise of the die using the following equation:

$$T_J = T_C + (P_{TOTAL} \cdot \theta_{JC}) \quad (\text{eq. 15})$$

$\theta_{JC}$  is the junction-to-case thermal resistance equal to 1.7°C/W.  $T_C$  is the temperature of the case and  $T_J$  is the junction temperature, or die temperature. The case-to-ambient thermal resistance is dependent on how well heat can be transferred from the PC board to the air. Solder the underside-exposed pad to a large copper GND plane. If the die temperature reaches +185°C the NCP1595/A/C shut down and does not restart again until the die temperature cools by 40°C.

### Layout Consideration

As with all high frequency switchers, when considering layout, care must be taken in order to achieve optimal electrical, thermal and noise performance. For 1.0MHz switching frequency, switch rise and fall times are typically in few nanosecond range. To prevent noise both radiated and conducted the high speed switching current path must be kept as short as possible. Shortening the current path will also reduce the parasitic trace inductance of approximately 25 nH/inch. At switch off, this parasitic inductance produces a flyback spike across the NCP1595/A/C switch. When operating at higher currents and input voltages, with poor layout, this spike can generate voltages across the NCP1595/A/C that may exceed its absolute maximum rating. A ground plane should always be used under the switcher circuitry to prevent interplane coupling and overall noise.

The FB component should be kept as far away as possible from the switch node. The ground for these components should be separated from the switch current path. Failure to do so will result in poor stability or subharmonic like oscillation.

Board layout also has a significant effect on thermal resistance. Reducing the thermal resistance from ground pin and exposed pad onto the board will reduce die temperature and increase the power capability of the NCP1595/A/C. This is achieved by providing as much copper area as possible around the exposed pad. Adding multiple thermal vias under and around this pad to an internal ground plane will also help. Similar treatment to the inductor pads will reduce any additional heating effects.

# MECHANICAL CASE OUTLINE

## PACKAGE DIMENSIONS

ON Semiconductor®



1  
SCALE 2:1

DFN6 3\*3 MM, 0.95 PITCH  
CASE 506AH-01  
ISSUE O

DATE 17 NOV 2004

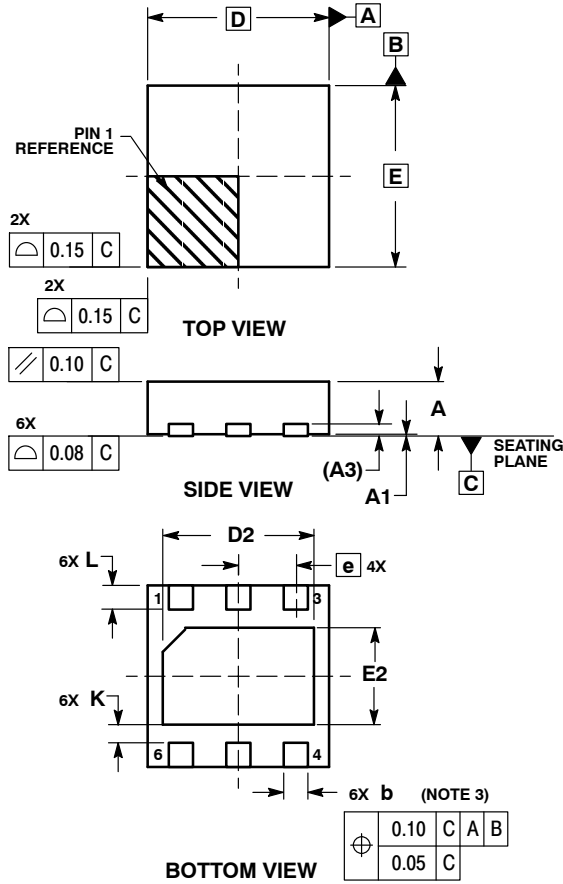

NOTES:

1. DIMENSIONS AND TOLERANCING PER ASME Y14.5M, 1994.
2. CONTROLLING DIMENSION: MILLIMETERS.
3. DIMENSION b APPLIES TO PLATED TERMINAL AND IS MEASURED BETWEEN 0.25 AND 0.30 MM FROM TERMINAL.
4. COPLANARITY APPLIES TO THE EXPOSED PAD AS WELL AS THE TERMINALS.

| MILLIMETERS |          |      |      |
|-------------|----------|------|------|
| DIM         | MIN      | NOM  | MAX  |
| A           | 0.80     | 0.90 | 1.00 |
| A1          | 0.00     | 0.03 | 0.05 |
| A3          | 0.20 REF |      |      |
| b           | 0.35     | 0.40 | 0.45 |
| D           | 3.00 BSC |      |      |
| D2          | 2.40     | 2.50 | 2.60 |
| E           | 3.00 BSC |      |      |
| E2          | 1.50     | 1.60 | 1.70 |
| e           | 0.95 BSC |      |      |
| K           | 0.21     | ---  | ---  |
| L           | 0.30     | 0.40 | 0.50 |

### GENERIC MARKING DIAGRAM\*

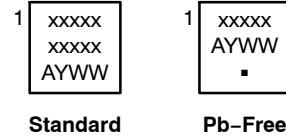

- xxxxx = Specific Device Code  
 A = Assembly Location  
 Y = Year  
 WW = Work Week  
 ■ = Pb-Free Package

### SOLDERING FOOTPRINT\*

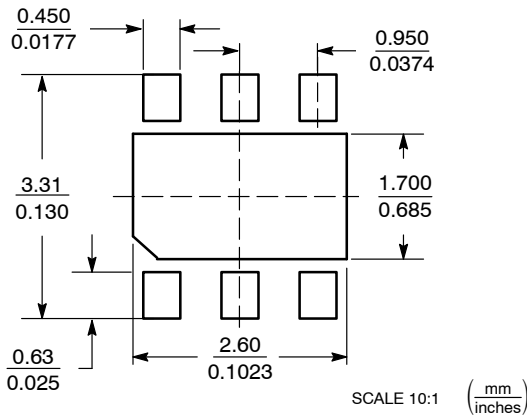

\*This information is generic. Please refer to device data sheet for actual part marking.  
 Pb-Free indicator, "G" or microdot "■", may or may not be present.

\*For additional information on our Pb-Free strategy and soldering details, please download the ON Semiconductor Soldering and Mounting Techniques Reference Manual, SOLDERRM/D.

|                  |                                      |   |
|------------------|--------------------------------------|---|
| DOCUMENT NUMBER: | 98AON19891D                          | Electronic versions are uncontrolled except when accessed directly from the Document Repository.<br>Printed versions are uncontrolled except when stamped "CONTROLLED COPY" in red. |
| DESCRIPTION:     | DFN6 3*3 MM, 0.95 PITCH, SINGLE FLAG | PAGE 1 OF 1   |

ON Semiconductor and ON are trademarks of Semiconductor Components Industries, LLC dba ON Semiconductor or its subsidiaries in the United States and/or other countries. ON Semiconductor reserves the right to make changes without further notice to any products herein. ON Semiconductor makes no warranty, representation or guarantee regarding the suitability of its products for any particular purpose, nor does ON Semiconductor assume any liability arising out of the application or use of any product or circuit, and specifically disclaims any and all liability, including without limitation special, consequential or incidental damages. ON Semiconductor does not convey any license under its patent rights nor the rights of others.

**onsemi**, **Onsemi**, and other names, marks, and brands are registered and/or common law trademarks of Semiconductor Components Industries, LLC dba "**onsemi**" or its affiliates and/or subsidiaries in the United States and/or other countries. **onsemi** owns the rights to a number of patents, trademarks, copyrights, trade secrets, and other intellectual property. A listing of **onsemi**'s product/patent coverage may be accessed at [www.onsemi.com/site/pdf/Patent-Marking.pdf](http://www.onsemi.com/site/pdf/Patent-Marking.pdf). **onsemi** reserves the right to make changes at any time to any products or information herein, without notice. The information herein is provided "as-is" and **onsemi** makes no warranty, representation or guarantee regarding the accuracy of the information, product features, availability, functionality, or suitability of its products for any particular purpose, nor does **onsemi** assume any liability arising out of the application or use of any product or circuit, and specifically disclaims any and all liability, including without limitation special, consequential or incidental damages. Buyer is responsible for its products and applications using **onsemi** products, including compliance with all laws, regulations and safety requirements or standards, regardless of any support or applications information provided by **onsemi**. "Typical" parameters which may be provided in **onsemi** data sheets and/or specifications can and do vary in different applications and actual performance may vary over time. All operating parameters, including "Typicals" must be validated for each customer application by customer's technical experts. **onsemi** does not convey any license under any of its intellectual property rights nor the rights of others. **onsemi** products are not designed, intended, or authorized for use as a critical component in life support systems or any FDA Class 3 medical devices or medical devices with a same or similar classification in a foreign jurisdiction or any devices intended for implantation in the human body. Should Buyer purchase or use **onsemi** products for any such unintended or unauthorized application, Buyer shall indemnify and hold **onsemi** and its officers, employees, subsidiaries, affiliates, and distributors harmless against all claims, costs, damages, and expenses, and reasonable attorney fees arising out of, directly or indirectly, any claim of personal injury or death associated with such unintended or unauthorized use, even if such claim alleges that **onsemi** was negligent regarding the design or manufacture of the part. **onsemi** is an Equal Opportunity/Affirmative Action Employer. This literature is subject to all applicable copyright laws and is not for resale in any manner.

## PUBLICATION ORDERING INFORMATION

### LITERATURE FULFILLMENT:

Email Requests to: [orderlit@onsemi.com](mailto:orderlit@onsemi.com)

**onsemi Website:** [www.onsemi.com](http://www.onsemi.com)

### TECHNICAL SUPPORT

**North American Technical Support:**

Voice Mail: 1 800-282-9855 Toll Free USA/Canada

Phone: 011 421 33 790 2910

**Europe, Middle East and Africa Technical Support:**

Phone: 00421 33 790 2910

For additional information, please contact your local Sales Representative