

Chip Multilayer Ceramic Capacitors for General

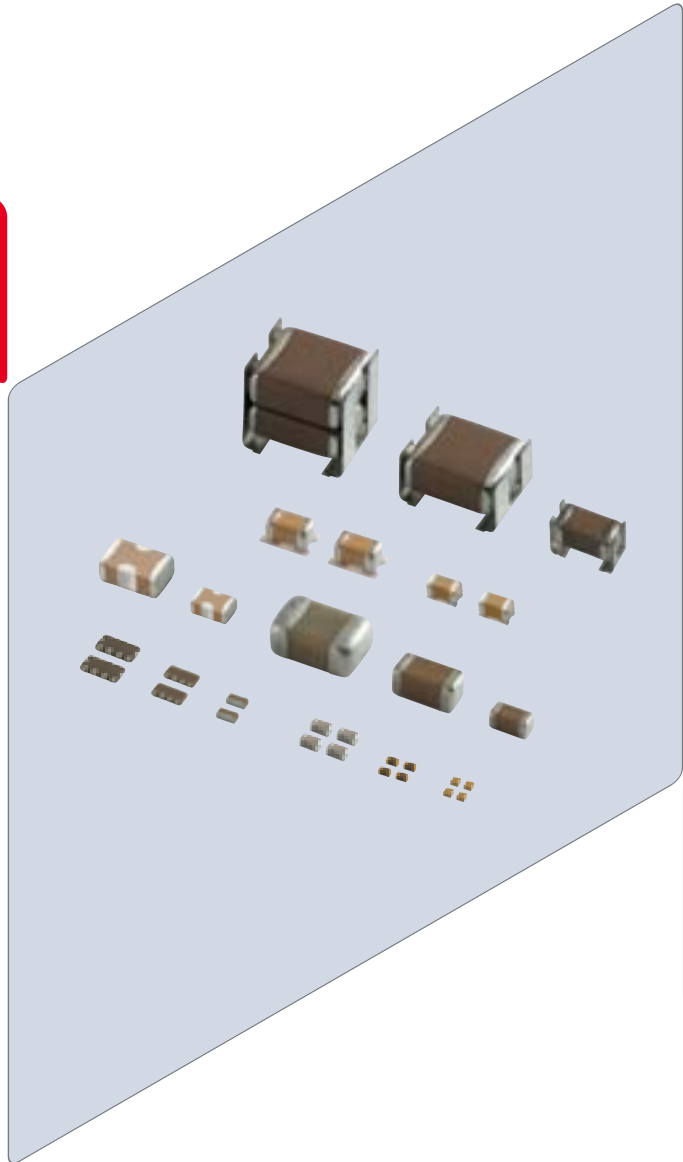

2020

Contents

Product specifications are as of November 2020.

Explanation of Symbols in This Catalog	p3	
Selection Guide	p5	
Catalog information	p6	
Part Numbering	p7	
Capacitance Table	p11	
		<small>Cap. Table</small>
Chip Multilayer Ceramic Capacitors for General Purpose		
GRM Series	p27	p11
High Effective Capacitance & High Ripple Current Chip Multilayer Ceramic Capacitors for General Purpose GR3 Series	p111	p17
Chip Multilayer Ceramic Capacitors with Soft Termination for General Purpose GRJ Series	p113	p17
Chip Multilayer Ceramic Capacitors for Information Devices only GR4 Series	p115	p18
High Q Chip Multilayer Ceramic Capacitors for General Purpose (≤100Vdc) GJM Series	p118	p18
High Q and High Power Chip Multilayer Ceramic Capacitors for General Purpose (>100Vdc) QGM Series	p176	p19
Based on the Electrical Appliance and Material Safety Law of Japan Chip Multilayer Ceramic Capacitors for General Purpose GA2 Series	p209	p19
Safety Standard Certified Chip Multilayer Ceramic Capacitors for General Purpose / IEC60384-14 Class X2 GA3 Series Type GB	p211	p19
Safety Standard Certified Chip Multilayer Ceramic Capacitors for General Purpose / Acquired certifications of UL60950-1 GA3 Series Type GD	p214	p19
Safety Standard Certified Chip Multilayer Ceramic Capacitors for General Purpose / Acquired certifications of IEC60384-14 Class X1/Y2 and UL60950-1 GA3 Series Type GF	p217	p20
LW Reversed Low ESL Chip Multilayer Ceramic Capacitors for General Purpose LLL Series	p221	p20
8 Terminals Low ESL Chip Multilayer Ceramic Capacitors for General Purpose LLA Series	p224	p21
10 Terminals Low ESL Chip Multilayer Ceramic Capacitors for General Purpose LLM Series	p226	p21
LW Reversed Controlled ESR Low ESL Chip Multilayer Ceramic Capacitors for General Purpose LLR Series	p228	p21
3 Terminals Low ESL Chip Multilayer Ceramic Capacitors for General Purpose NFM Series	p230	p21
Low Distortion Chip Multilayer Ceramic Capacitors for General Purpose GJ4 Series	p234	p22
Low Acoustic Noise Chip Multilayer Ceramic Capacitors on Interposer Board for General Purpose ZRA Series	p237	p22
Low Acoustic Noise Chip Multilayer Ceramic Capacitors on Interposer Board for General Purpose ZRB Series	p239	p22
Metal Terminal Type Multilayer Ceramic Capacitors for General Purpose KRM Series	p241	p23
High Effective Capacitance & High Allowable Ripple Current Metal Terminal Type Multilayer Ceramic Capacitors for General Purpose KR3 Series	p245	p24
Wire Bonding Mount Multilayer Microchip Capacitors for General Purpose GMA Series	p248	p24
Wire Bonding/AuSn Soldering Mount Chip Multilayer Ceramic Capacitors for General Purpose GMD Series	p253	p25
△Caution/Notice/Soldering and Mounting	p258	
Introduction of Website SimSurfing	p284	
Product Information	p285	















Please check the MURATA website (<https://www.murata.com/>) if you cannot find a part number in this catalog.

GRM
GR3
GRJ
GR4
GJM
QGM
GA2
GA3 GB
GA3 GD
GA3 GF
LLL
LLA
LLM
LLR
NFM
GJ4
ZRA
ZRB
KRM
KR3
GMA
GMD
△Caution/Notice

Explanation of Symbols in This Catalog



Links are provided to the latest information from the PDF version of the catalog, which is available on the web.

 General	For applications that do not require the particular reliability such as the general equipment	 High Q	Low dissipation for high frequency By devising ceramic materials and electrode materials, low dissipation is achieved in frequency bands of VHF, UHF and microwave or beyond.
 Infotainment	Infotainment for Automotive The product for entertainment equipment like car navigations, car audios, and body control equipment like wipers, power windows.	 Low ESL	Low inductance This capacitor is designed so that the parasitic inductance component (ESL) that the capacitor has on the high frequency side becomes lower.
 Powertrain	Powertrain/Safety for Automotive Product used for applications (running, turning, stopping and safety devices) which particularly concern human life, such as in devices for automobiles.	 Deflecting crack	Product resistant to deflection cracking This capacitor is designed to prevent failures as much as possible by short mode caused by cracking when there is board deflection.
 Medical Device	Medical-grade products for Implanted Medical Devices These products are intended for use in implanted medical devices such as cardiac pacemakers, cochlear implants, insulin pumps and gastric electrostimulators. They are suitable for use in non-critical circuits. *1 *1 Non-critical circuits This term refers to circuits in implanted medical devices that are not directly linked to life support, i.e. circuits that will not directly endanger the life of the patient should the functionality of the device be reduced or halted by failure of the circuit.	 Soldering crack	Product with solder cracking suppression "This capacitor is configured with metal terminals and leads connected to the chip. The metal terminals and leads relieve the stress from expansion and contraction of the solder, to suppress solder cracking."
 AEC-Q200	AEC-Q200 compliant product	 Low acoustic noise	Product suitable for acoustic noise reduction and low distortion This product suppresses acoustic noise, which occurs when a ceramic capacitor is used, by devising the materials and configuration.
 Safety standard	Safety Standard Certified Product Products that acquired safety standard certification IEC60384-14 and products based on the Electrical Appliance and Material Safety Law of Japan.	 Effective Cap	No DC bias characteristics Polymer capacitor is no capacitance change with DC bias due to aluminum oxidized film for dielectric.
 Japanese Safety Law	Based on the Electrical Appliance and Material Safety Law of Japan Products that are based on the electrical appliance and material safety law of Japan.	 EMI Filter	Low-inductance product suitable for noise suppression. This product has extremely low ESL and is suitable for suppression of noise, including high frequencies. This product can also be used as a low-ESL, high-performance bypass capacitor.
		 Bonding	Product for bonding Since gold is used for the external electrodes, the capacitor can be mounted by die bonding/wire bonding.

EU RoHS Compliant

- All the products in this catalog comply with EU RoHS.
- EU RoHS is "the European Directive 2011/65/EU on the Restriction of the Use of Certain Hazardous Substances in Electrical and Electronic Equipment."
- For more details, please refer to our web page, "Murata's Approach for EU RoHS" (<https://www.murata.com/en-eu/support/compliance/rohs>).

Qualified Standards

- The products listed here have been produced by ISO 9001 certified factory.
- <Plant>
- Fukui Murata Mfg. Co., Ltd.
 - Izumo Murata Mfg. Co., Ltd.
 - Murata Electronics Singapore (Pte.) Ltd.
 - Wuxi Murata Electronics Co., Ltd.
 - PHILIPPINE MANUFACTURING CO. OF MURATA, INC.

Explanation of Symbols in This Catalog

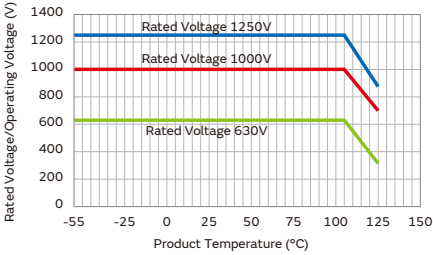
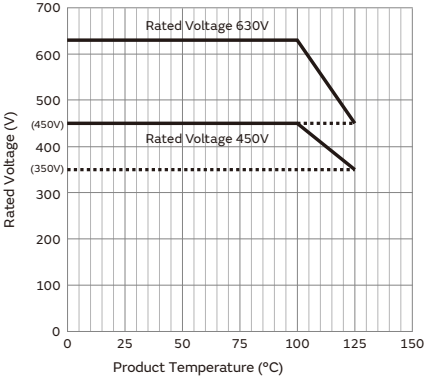
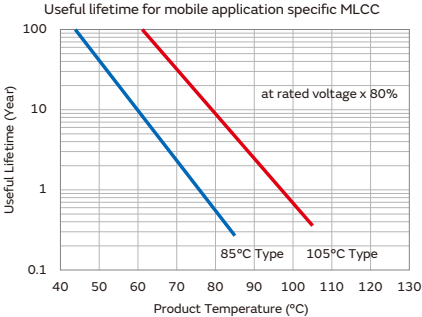
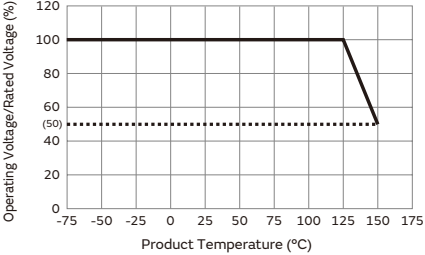
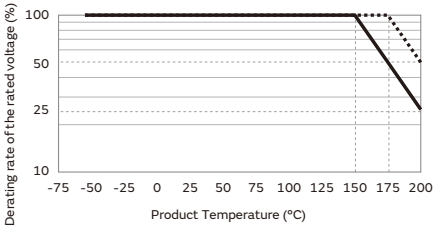
<p>D1 Derating 1</p>	<p>Derating 1 The test voltage of these products is less than 150% of the rated voltage in the Durability / Operational Life Test. *Usually MLCC used with derating. So even this kind of products, special derating have not set specially. Please refer to below links for details For general purpose Only for mobile devices For automotive</p>	<p>Derating 6 When the product temperature exceeds 105°C, please use this product within the voltage and temperature derated conditions in the figure below.</p> 
<p>D2 Derating 2</p>	<p>Derating 2 When the product temperature exceeds 105°C, please use this product within the voltage and temperature derated conditions in the figure below.</p> 	<p>Mobile application specific MLCC These MLCC products are designed for use in devices with a typical lifetime of less than 5 years. (Examples: Cellular phone, Smartphone, Tablet PC, Digital camera, Watch, Electronics dictionary, Small-scale server, IPC-9592B class1 equipment, etc.) These MLCC products are designed so that the useful lifetime can be extended longer than 5 years under the following conditions: [80% of the rated voltage or less, Maximum operating temperature -20 degree C or less] Extended useful lifetime, under specific operating conditions, can be estimated from the following chart.</p> <ul style="list-style-type: none"> * The useful lifetime is the time when cumulative failure rate becomes 1%. * Please note that the useful lifetime data is for reference only and not guaranteed. * If you have any questions, please feel free to contact us. <p>Lifetime of MLCC can also be estimated from voltage acceleration and temperature acceleration factors. Please refer to following URL about these lifetime estimation. Ceramic Capacitors FAQ "Are there any methods for estimating the lifetime of a capacitor?"</p> 
<p>D3 Derating 3</p>	<p>Derating 3 Please apply the derating curve according to the operating temperature. Please refer to detailed specifications sheet for details.</p>	<p>Mo For only mobile devices</p>
<p>D4 Derating 4</p>	<p>Derating 4 When the product temperature exceeds 125°C, please use this product within the voltage and temperature derated conditions in the figure below.</p> 	
<p>D5 Derating 5</p>	<p>Derating 5 When the product temperature exceeds 150°C, please use this product within the voltage and temperature derated conditions in the figure below.</p>  <p>..... Temp. Char.: CCG, Rated Voltage: 100V, Capacitance: 100pF-1000pF ——— Temp. Char.: CCG, Rated Voltage: 100V, Capacitance: 1200pF-3300pF Temp. Char.: UNJ, Rated Voltage: 200V/500V Temp. Char.: X9Q, Rated Voltage: 100V</p>	

Selection Guide for Ceramic Capacitors

For general			
General SMD			
Solder mounting			
Chip type			
	GRM		p27
	GR3	Anti-noise	High effective capacitance & high ripple current p111
	GRJ	Deflecting crack	Soft termination p113
	GR4		For information devices only p115
	GJM	High Q	p118
	GQM	High Q	High power p176
	GA2	Japanese Safety Law	Based on the Electrical Appliance and Material Safety Law of Japan p209
	GA3	Safety standard	p211
	LLL	Low ESL	LW reversed p221
	LLA	Low ESL	8 terminals p224
	LLM	Low ESL	10 terminals p226
	LLR	Low ESL	LW reversed controlled ESR p228
	NFM	Low ESL EMI Filter	3 terminals p230
	GJ4	Anti-noise	Low distortion p234
On interposer board			
	ZRA	Anti-noise	p237
	ZRB	Anti-noise	p239
Metal terminal type			
	KRM	Anti-noise Deflecting crack Soldering crack	p241
	KR3	Anti-noise Deflecting crack Soldering crack	High effective capacitance & high ripple current p245
Resin molding SMD type			
	DK1	Safety standard	WEB
Wire bonding mounting			
Bonding Chip type			
	GMA		Microchip p248
	GMD		p253
Lead type			
Solder mounting			
	RDE	Anti-noise Deflecting crack Soldering crack	WEB
	DE1	Safety standard	X1/Y1 Class certified product WEB
	DE2	Safety standard	X1/Y2 Class certified product WEB

Infotainment for automotive			
SMD			
Solder mounting			
Chip type			
	GRT		WEB
	NFM	Low ESL EMI Filter	3 terminals WEB

Powertrain/Safety for automotive			
SMD			
Solder mounting			
Chip type			
	GCM		WEB
	GC3	Anti-noise	High effective capacitance & high ripple current WEB
	GCJ	Deflecting crack	Soft termination WEB
	GCQ	High Q	WEB
	GCD	Deflecting crack	MLSC design WEB
	GCE	Deflecting crack	Soft termination MLSC design WEB
	LLC	Low ESL	LW reversed WEB
	NFM	Low ESL EMI Filter	3 terminals WEB
Metal terminal type			
	KCM	Anti-noise Deflecting crack Soldering crack	WEB
	KC3	Anti-noise Deflecting crack Soldering crack	High effective capacitance & high ripple current WEB
	KCA	Safety standard Anti-noise Deflecting crack Soldering crack	WEB
Limited to Conductive Glue Mounting			
Chip type			
	GCB	Deflecting crack Soldering crack	Ni plating + Pd plating termination conductive glue mounting WEB
	GCG	Deflecting crack Soldering crack	AgPd termination conductive glue mounting WEB
Lead type			
Solder mounting			
	RCE	Anti-noise Deflecting crack Soldering crack	WEB
	RHE	Anti-noise Deflecting crack Soldering crack	150°C operation leaded WEB
	RHS	Anti-noise Deflecting crack Soldering crack	200°C operation leaded WEB
	DE6	Safety standard	WEB

Medical-grade products for implanted medical devices			
SMD			
Solder mounting			
Chip type			
	GCH		WEB

Catalog Information

Catalog relates to a multilayer ceramic capacitor is below.

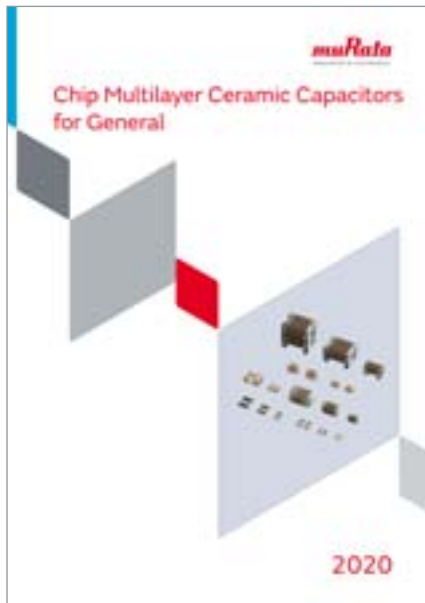

Chip Multilayer Ceramic Capacitors for General

Cat No. C02E-23

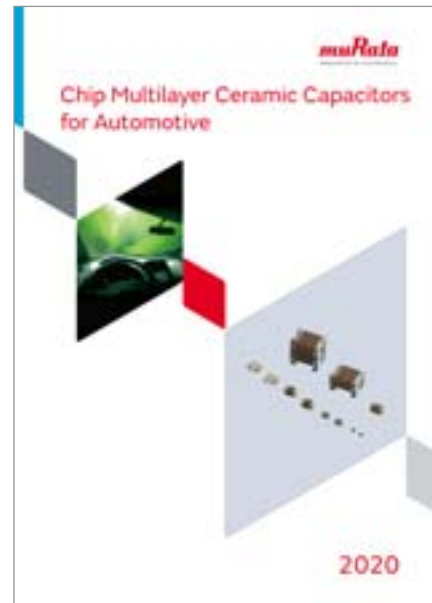

Chip Multilayer Ceramic Capacitors for Automotive

Cat No. C03E-11



Lead Type Disc Ceramic Capacitors (Safety Standard Certified) Resin Molding SMD Type Ceramic Capacitors (Safety Standard Certified)

Cat No. C85E-7



Leaded MLCC

Cat No. C49E-26

● Part Numbering

Chip Multilayer Ceramic Capacitors for General



(Part Number)



① Product ID ② Series

Product ID	Code	Series
GA	2	Based on the Electrical Appliance and Material Safety Law of Japan Chip Multilayer Ceramic Capacitors for General Purpose
	3	Safety Standard Certified Chip Multilayer Ceramic Capacitors for General Purpose
GC	H	Chip Multilayer Ceramic Capacitors for Implantable Medical Devices (Non Life Support Circuit)
GJ	4	Low Distortion Chip Multilayer Ceramic Capacitors for General Purpose
	M	High Q Chip Multilayer Ceramic Capacitors for General Purpose (≤100Vdc)
GM	A	Wire Bonding Mount Multilayer Microchip Capacitors for General Purpose
	D	Wire Bonding/AuSn Soldering Mount Chip Multilayer Ceramic Capacitors for General Purpose
GQ	M	High Q Chip Multilayer Ceramic Capacitors for General Purpose (>100Vdc)
GR	3	High Effective Capacitance & High Ripple Current Chip Multilayer Ceramic Capacitors for General Purpose
	4	Chip Multilayer Ceramic Capacitors for Ethernet LAN and Primary-secondary coupling of DC-DC Converters
		Chip Multilayer Ceramic Capacitors for Splitter Circuit of G-Fast, xDSL
	J	Soft Termination Chip Multilayer Ceramic Capacitors for General Purpose
M	Chip Multilayer Ceramic Capacitors for General Purpose	
	Chip Multilayer Ceramic Capacitors for LCD Backlight Inverter Circuit only	
KR	3	High Effective Capacitance & High Allowable Ripple Current Metal Terminal Type Multilayer Ceramic Capacitors for General Purpose
	M	Metal Terminal Type Multilayer Ceramic Capacitors for General Purpose
LL	A	8 Terminals Low ESL Chip Multilayer Ceramic Capacitors for General Purpose
	L	LW Reversed Low ESL Chip Multilayer Ceramic Capacitors for General Purpose
	M	10 Terminals Low ESL Chip Multilayer Ceramic Capacitors for General Purpose
	R	LW Reversed Controlled ESR Low ESL Chip Multilayer Ceramic Capacitors for General Purpose
ZR	A	Low Acoustic Noise Chip Multilayer Ceramic Capacitors on Interposer Board for General Purpose
	B	Low Acoustic Noise Chip Multilayer Ceramic Capacitors on Interposer Board for General Purpose

③ Chip Dimensions (LxW) (Except ZRA)

Code	Dimensions (LxW)	EIA
01	0.25x0.125mm	008004
02	0.4x0.2mm	01005
0D	0.38x0.38mm	015015
MD	0.5x0.25mm	015008
03	0.6x0.3mm	0201
05	0.5x0.5mm	0202
08	0.8x0.8mm	0303
1U	0.6x1.0mm	02404
15	1.0x0.5mm	0402
18	1.6x0.8mm	0603
JN	1.8x1.0mm	0704
21	2.0x1.25mm	0805
22	2.8x2.8mm	1111
31	3.2x1.6mm	1206
32	3.2x2.5mm	1210
42	4.5x2.0mm	1808
43	4.5x3.2mm	1812
52	5.7x2.8mm	2211
55	5.7x5.0mm	2220

④ Dimensions (LxW) (ZRA Only)

Code	Dimensions (LxW)
21	2.4x1.65mm

Continued on the following page. ↗

(Part Number)

GR	M	18	8	B1	1H	102	K	A01	D
1	2	3	4	5	6	7	8	9	10

Continued from the preceding page. ↘

④ Height Dimension (T) (Except KR□)

Code	Dimension (T)
1	0.125mm
2	0.2mm
3	0.3mm
4	0.4mm
5	0.5mm
6	0.6mm
7	0.7mm
8	0.8mm
9	0.85mm
A	1.0mm
B	1.25mm
C	1.6mm
D	2.0mm
E	2.5mm
M	1.15mm
Q	1.5mm
T	0.18mm
X	Depends on individual standards.
Y	0.135mm

④ Height Dimension (T) (KR□ Only)

Code	Dimension (T)
E	1.8mm
F	1.9mm
K	2.7mm
L	2.8mm
R	3.6mm
Q	3.7mm
T	4.8mm
V	6.2mm
W	6.4mm

⑤ Temperature Characteristics

Temperature Characteristic Codes		Temperature Characteristics				Operating Temperature Range	Capacitance Change Each Temperature (%)					
Code	Public STD Code	Reference Temperature	Temperature Range	Capacitance Change or Temperature Coefficient	-55°C		*4		-10°C			
					Max.		Min.	Max.	Min.	Max.	Min.	
1C	CG	JIS	20°C	20 to 125°C	0±30ppm/°C	-55 to 125°C	0.54	-0.23	0.33	-0.14	0.22	-0.09
1X	SL	JIS	20°C	20 to 85°C	+350 to -1000ppm/°C	-55 to 125°C	-	-	-	-	-	-
2C	CH	JIS	20°C	20 to 125°C	0±60ppm/°C	-55 to 125°C	0.82	-0.45	0.49	-0.27	0.33	-0.18
3C	CJ	JIS	20°C	20 to 125°C	0±120ppm/°C	-55 to 125°C	1.37	-0.9	0.82	-0.54	0.55	-0.36
3U	UJ	JIS	20°C	20 to 85°C	-750±120ppm/°C	-25 to 85°C	-	-	4.94	2.84	3.29	1.89
4C	CK	JIS	20°C	20 to 125°C	0±250ppm/°C	-55 to 125°C	2.56	-1.88	1.54	-1.13	1.02	-0.75
5C	C0G	EIA	25°C	25 to 125°C	0±30ppm/°C	-55 to 125°C	0.58	-0.24	0.4	-0.17	0.25	-0.11
5G	X8G	*2	25°C	25 to 150°C	0±30ppm/°C	-55 to 150°C	0.58	-0.24	0.4	-0.17	0.25	-0.11
7U	U2J	EIA	25°C	25 to 125°C *3	-750±120ppm/°C	-55 to 125°C	8.78	5.04	6.04	3.47	3.84	2.21
B1	B *1	JIS	20°C	-25 to 85°C	±10%	-25 to 85°C	-	-	-	-	-	-
B3	B	JIS	20°C	-25 to 85°C	±10%	-25 to 85°C	-	-	-	-	-	-
C6	X5S	EIA	25°C	-55 to 85°C	±22%	-55 to 85°C	-	-	-	-	-	-
C7	X7S	EIA	25°C	-55 to 125°C	±22%	-55 to 125°C	-	-	-	-	-	-
C8	X6S	EIA	25°C	-55 to 105°C	±22%	-55 to 105°C	-	-	-	-	-	-
D7	X7T	EIA	25°C	-55 to 125°C	+22%, -33%	-55 to 125°C	-	-	-	-	-	-
D8	X6T	EIA	25°C	-55 to 105°C	+22%, -33%	-55 to 105°C	-	-	-	-	-	-
E7	X7U	EIA	25°C	-55 to 125°C	+22%, -56%	-55 to 125°C	-	-	-	-	-	-
R1	R *1	JIS	20°C	-55 to 125°C	±15%	-55 to 125°C	-	-	-	-	-	-
R6	X5R	EIA	25°C	-55 to 85°C	±15%	-55 to 85°C	-	-	-	-	-	-
R7	X7R	EIA	25°C	-55 to 125°C	±15%	-55 to 125°C	-	-	-	-	-	-
R8	R *1	JIS	20°C	-25 to 85°C	±15%	-25 to 85°C	-	-	-	-	-	-
Z7	X7R	EIA	25°C	-55 to 125°C	±15% *5	-55 to 125°C	-	-	-	-	-	-

*1 Capacitance change is specified with 50% rated voltage applied.

*2 Murata Temperature Characteristic Code.

*3 Rated Voltage 100Vdc max: 25 to 85°C

*4 -25°C (Reference Temperature 20°C) / -30°C (Reference Temperature 25°C)

*5 Range of capacitance change rate with 50% rated voltage applied (See detailed specifications sheet).

Continued on the following page. ↗

(Part Number)

GR	M	18	8	B1	1H	102	K	A01	D
1	2	3	4	5	6	7	8	9	10

Continued from the preceding page. ↘

⑥ Rated Voltage

Code		Rated Voltage
Standard Product	Voltage Derated Product	
0E	-	DC2.5V
0G	-	DC4V
0J	-	DC6.3V
1A	-	DC10V
1C	-	DC16V
1E	-	DC25V
1H	-	DC50V
1J	-	DC63V
2A	-	DC100V
2D	-	DC200V
2E	-	DC250V
2W	-	DC450V
2H	-	DC500V
2J	-	DC630V
3A	LW	DC1kV
3B	LX	DC1.25kV
3D	-	DC2kV
3F	-	DC3.15kV
E2	-	AC250V
GB	-	X2; AC250V (Safety Standard Certified Type GB)
GD	-	Y3; AC250V (Safety Standard Certified Type GD)
GF	-	Y2, X1/Y2; AC250V (Safety Standard Certified Type GF)
YA	-	DC35V

⑦ Capacitance

Expressed by three-digit alphanumerics. The unit is picofarad (pF). The first and second figures are significant digits, and the third figure expresses the number of zeros which follow the two numbers. If there is a decimal point, it is expressed by the capital letter "R." In this case, all figures are significant digits. If any alphabet, other than "R", is included, this indicates the specific part number is a non-standard part.

Ex.)

Code	Capacitance
R50	0.50pF
1R0	1.0pF
100	10pF
103	10000pF

⑧ Capacitance Tolerance

Code	Capacitance Tolerance
B	±0.1pF
C	±0.25pF
D	±0.5pF (Less than 10pF) ±0.5% (10pF and over)
F	±1%
G	±2%
J	±5%
K	±10%
M	±20%
R	Depends on individual standards.
W	±0.05pF

⑨ Individual Specification Code (Except LLR)

Expressed by three figures.

⑩ ESR (LLR Only)

Code	ESR
E01	100mΩ
E03	220mΩ
E05	470mΩ
E07	1000mΩ

⑩ Packaging

Code	Packaging
L	ø180mm Embossed Taping
D/E/W	ø180mm Paper Taping
K	ø330mm Embossed Taping
J/F	ø330mm Paper Taping
T	Bulk Tray

Please contact us if you find any part number not provided in this table.

3 Terminal Low ESL Monolithic Ceramic Capacitors



(Part Number)

NF	M	3D	CC	102	R	1H	3	L
①	②	③	④	⑤	⑥	⑦	⑧	⑨

① Product ID ② Series

Product ID	Series
NFM	3 Terminal Low ESL Type

③ Dimensions (LxW)

Code	Dimensions (LxW)	EIA
15	1.0x0.5mm	0402
JM	1.2x0.9mm	05035
18	1.6x0.8mm	0603
21	2.0x1.25mm	0805
3D	3.2x1.25mm	1205
31	3.2x1.6mm	1206
41	4.5x1.6mm	1806

④ Features

Code	Features	
CC	For General	For Signal Lines
PC		For Large Current
PL		Low-profile Type for Large Current
PS		High Insertion Loss Type for Large Current
KC		For Very Large Current
TC	Infotainment for Automotive	For Large Current
HC	Powertrain/Safety for Automotive	For Signal Lines / For Large Current
HK		For Very Large Current

⑤ Capacitance

Expressed by three figures. The unit is in pico-farad (pF). The first and second figures are significant digits, and the third figure expresses the number of zeros that follow the two figures.

⑥ Characteristics

Code	Capacitance Temperature Characteristics
B	±10%, ±12.5%, +10/-13%
C	±22%
D	+22/-33%
R	±15%, +15/-18%

⑦ Rated Voltage

Code	Rated Voltage
0E	2.5V
0G	4V
0J	6.3V
1A	10V
1C	16V
1E	25V
1H	50V
2A	100V

⑧ Electrode (Except NFM□□PL)

Code	Electrode
3	Sn Plating

⑨ Height Dimension (T) (NFM□□PL Only)

Code	Height Dimension (T)
5	0.65mm max.

⑩ Packaging

Code	Packaging
B	Bulk
L	Embossed Taping (ø180mm Reel)
D	Paper Taping (ø180mm Reel)

Capacitance Table

GRM Series Temperature Compensating Type

p00 ← Part Number List

JIS: CK CJ CH SL UJ

EIA: C0G U2J

L×W	Rated Voltage	TC Code	Capacitance										Capacitance Range	Page				
			pF					μF										
			0.1	1	10	100	1000	0.01	0.1	1	10	100			1000			
0.25×0.125mm	25Vdc	C0G	█	█	█	█										0.20pF - 100pF	p28 - p31	
	16Vdc	C0G	█	█	█	█										0.20pF - 100pF	p31 - p35	
0.4×0.2mm	50Vdc	C0G	█	█	█	█										0.20pF - 100pF	p35 - p38	
		CH			█	█										4.0pF - 100pF	p38 - p41	
		CJ			█											2.1pF - 3.9pF	p41	
		CK	█	█	█											0.20pF - 2.0pF	p41 - p42	
	35Vdc	C0G														100pF	p42	
		25Vdc	C0G	█	█	█	█									0.20pF - 220pF	p42 - p45	
	16Vdc	CH			█	█										4.0pF - 220pF	p46 - p48	
		CJ			█											2.1pF - 3.9pF	p48 - p49	
		CK	█	█	█											0.20pF - 2.0pF	p49	
		C0G	█	█	█	█										0.20pF - 220pF	p49 - p53	
	10Vdc	CH														4.0pF - 220pF	p53 - p55	
		CJ			█											2.1pF - 3.9pF	p56	
6.3Vdc	CK	█	█	█											0.20pF - 2.0pF	p56		
	C0G														51pF - 220pF	p56 - p57		
0.6×0.3mm	100Vdc	CH														51pF - 220pF	p57	
		CJ			█											51pF - 220pF	p57	
		CK	█	█	█											51pF - 220pF	p57	
		C0G	█	█	█	█										0.10pF - 100pF	p57 - p61	
	50Vdc	CH														4.0pF - 100pF	p61 - p64	
		CJ			█											2.1pF - 3.9pF	p64	
		CK	█	█	█											0.10pF - 2.0pF	p64	
		C0G	█	█	█	█										0.10pF - 1000pF	p65 - p68	
	25Vdc	CH														4.0pF - 220pF	p68 - p71	
		CJ			█											2.1pF - 3.9pF	p71 - p72	
		CK	█	█	█											0.10pF - 2.0pF	p72	
		C0G	█	█	█	█										0.10pF - 1000pF	p72 - p78	
1.0×0.5mm	100Vdc	CH														4.0pF - 1000pF	p78 - p79	
		CJ			█											2.1pF - 3.9pF	p79	
		CK	█	█	█											0.10pF - 2.0pF	p79 - p80	
		C0G	█	█	█	█										0.10pF - 1000pF	p80	
	50Vdc	CH														270pF - 1000pF	p80 - p81	
		C0G														270pF - 1000pF	p81	
	35Vdc	C0G														10000pF	p81	
		25Vdc	C0G													10000pF	p81	
	10Vdc	U2J														2400pF - 4700pF	p81	
		UJ														2400pF - 4700pF	p81	
	1.6×0.8mm	250Vdc	C0G														10pF - 47pF	p81
			100Vdc	C0G													1000pF - 3900pF	p81
50Vdc		CH														1000pF - 3900pF	p81	
		C0G														1000pF - 10000pF	p81 - p82	
		CH														1000pF - 10000pF	p82	
		SL														2200pF - 4700pF	p82	
		U2J														2200pF - 4700pF	p82	
		UJ														2200pF - 4700pF	p82	
10Vdc		SL														5600pF - 33000pF	p82	
		U2J														5600pF - 33000pF	p82	
		UJ														5600pF - 33000pF	p82	
6.3Vdc		SL														24000pF - 33000pF	p82	
		U2J														24000pF - 33000pF	p82	
		UJ														24000pF - 33000pF	p82	
2.0×1.25mm		630Vdc	C0G														10pF - 2200pF	p83
			250Vdc	C0G													10pF - 10000pF	p83 - p84
		200Vdc	U2J														100pF - 5600pF	p84 - p85
			C0G														10pF - 330pF	p85

Continued on the following page. ↗

Capacitance Table

(→ GRM Series Temperature Compensating Type)

p00 ← Part Number List JIS: **CK** **CJ** **CH** **SL** **UJ** EIA: **COG** **U2J**

L×W	Rated Voltage	TC Code	Capacitance										Capacitance Range	Page				
			pF					μF										
			0.1	1	10	100	1000	0.01	0.1	1	10	100			1000			
2.0×1.25mm	200Vdc	U2J															100pF - 5600pF	p85
	100Vdc	COG															1000pF - 22000pF	p85 - p86
		CH															1000pF - 22000pF	p86
	50Vdc	COG															2400pF - 33000pF	p86
		CH															2400pF - 22000pF	p86
		SL															39000pF - 47000pF	p86
		U2J															39000pF - 47000pF	p86
		UJ															39000pF - 47000pF	p86
	10Vdc	SL															33000pF - 0.10μF	p86 - p87
		U2J															33000pF - 0.10μF	p87
UJ																33000pF - 0.10μF	p87	
3.2×1.6mm	2000Vdc	U2J															10pF - 68pF	p87
	1000Vdc	COG															10pF - 1000pF	p87
		U2J															10pF - 1000pF	p88
	630Vdc	COG															10pF - 10000pF	p88 - p89
		U2J															10pF - 4700pF	p89
	500Vdc	COG															10pF - 1000pF	p89 - p90
		U2J															10pF - 4700pF	p90
	250Vdc	COG															12000pF - 22000pF	p90
		U2J															6800pF - 10000pF	p90
	200Vdc	U2J															6800pF - 10000pF	p90
		COG															4300pF - 0.10μF	p90 - p91
	50Vdc	CH															5100pF - 0.10μF	p91
		COG															11000pF - 0.22μF	p91
		CH															11000pF - 0.10μF	p91
		SL															68000pF - 0.10μF	p91
		U2J															68000pF - 0.10μF	p91 - p92
	25Vdc	UJ															68000pF - 0.10μF	p92
COG																0.15μF - 0.22μF	p92	
3.2×2.5mm	2000Vdc	U2J															82pF - 220pF	p92
	1000Vdc	U2J															1200pF - 2200pF	p92
	630Vdc	COG															33000pF	p92
		U2J															1200pF - 15000pF	p92
	500Vdc	U2J															1200pF - 10000pF	p92
4.5×2.0mm	3150Vdc	U2J														10pF - 100pF	p92	
4.5×3.2mm	1000Vdc	U2J															2700pF - 4700pF	p92
	630Vdc	U2J															12000pF - 22000pF	p92
	500Vdc	U2J															12000pF - 22000pF	p92
5.7×5.0mm	1000Vdc	U2J															5600pF - 10000pF	p92
	630Vdc	U2J															27000pF - 47000pF	p92
	500Vdc	U2J															27000pF - 47000pF	p92

GRM Series High Dielectric Constant Type

p00 ← Part Number List JIS: **R** **B** EIA: **X7R** **X7S** **X7T** **X7U** **X6S** **X6T** **X5R** **X5S**

L×W	Rated Voltage	TC Code	Capacitance										Capacitance Range	Page				
			pF					μF										
			0.1	1	10	100	1000	0.01	0.1	1	10	100			1000			
0.25×0.125mm	10Vdc	X5R															100pF - 680pF	p93
	6.3Vdc	X5R															1000pF - 10000pF	p93
	4Vdc	X5R															3300pF - 10000pF	p93
0.4×0.2mm	16Vdc	X7R															56pF - 1000pF	p93
		X5R															680pF - 10000pF	p93
	10Vdc	X7R															56pF - 1000pF	p93 - p94
		X5R															56pF - 0.10μF	p94

Continued on the following page. ↗

Capacitance Table

(→ GRM Series High Dielectric Constant Type)

p00 ← Part Number List JIS: R B EIA: X7R X7S X7T X7U X6S X6T X5R X5S

L×W	Rated Voltage	TC Code	Capacitance										Capacitance Range	Page				
			pF					μF										
			0.1	1	10	100	1000	0.01	0.1	1	10	100			1000			
0.4×0.2mm	10Vdc	B														56pF - 10000pF	p94 - p95	
	6.3Vdc	X5R														680pF - 0.47μF	p95	
		B														680pF - 10000pF	p95 - p96	
	4Vdc	X6T														0.10μF - 0.47μF	p96	
		X5R														15000pF - 0.47μF	p96	
	2.5Vdc	X7T														0.47μF	p96	
X6T															0.10μF - 0.47μF	p96		
0.5×0.25mm	6.3Vdc	X5R													1.0μF	p96		
0.6×0.3mm	50Vdc	X7R														100pF - 1500pF	p96	
		X5R														470pF	p96	
		B														100pF - 1500pF	p96 - p97	
	35Vdc	X5R														0.10μF	p97	
		25Vdc	X7R														100pF - 10000pF	p97
			R														100pF - 1500pF	p97 - p98
		X6S														10000pF - 0.10μF	p98	
		X5R														100pF - 0.22μF	p98	
		B														100pF - 10000pF	p98	
	16Vdc	X7R														100pF - 10000pF	p98 - p99	
		X7S														0.10μF	p99	
		R														100pF - 3300pF	p99	
		X6S														0.10μF	p99	
		X5R														2200pF - 2.2μF	p99 - p100	
		B														100pF - 0.10μF	p100	
	10Vdc	X7R														0.10μF	p100	
		X7R														1200pF - 10000pF	p100 - p101	
		X7S														0.10μF	p101	
		R														1200pF - 10000pF	p101	
		X6S														47000pF - 1.0μF	p101	
		X5R														1200pF - 2.2μF	p101 - p102	
		B														1000pF - 0.10μF	p102	
		X7R														0.10μF	p102	
	6.3Vdc	X7R														1200pF - 10000pF	p102 - p103	
X7S															0.10μF	p103		
X7T															1.0μF	p103		
R															1200pF - 10000pF	p103		
X6S															12000pF - 2.2μF	p103		
X5R															2200pF - 4.7μF	p103 - p104		
B															1200pF - 0.22μF	p104		
X7R															0.10μF	p104		
4Vdc	X7T														1.0μF - 2.2μF	p104		
	X6S														12000pF - 1.0μF	p104		
	X6T														1.0μF	p104		
	X5R														0.22μF - 4.7μF	p104		
	B														0.22μF	p104		
	X7T														1.0μF	p104		
2.5Vdc	X6S														0.22μF - 4.7μF	p104		
	X6T														2.2μF	p104		
	X5R														4.7μF	p104		
	X7R														220pF - 4700pF	p104 - p105		
	X5R														0.10μF	p105		
	B														2200pF - 0.10μF	p105		
1.0×0.5mm	100Vdc	X7R													47000pF - 0.10μF	p105		
		X7S													2200pF - 10000pF	p105		
		R													0.10μF - 1.0μF	p105		
	50Vdc	X5R													0.10μF	p105		
		B													0.10μF	p105		
		X6S													0.22μF	p105		
35Vdc	X5R													1.0μF - 2.2μF	p105			

Continued on the following page. ↗

Capacitance Table

(→ GRM Series High Dielectric Constant Type)

p00 ← Part Number List JIS: **R** **B** EIA: **X7R** **X7S** **X7T** **X7U** **X6S** **X6T** **X5R** **X5S**

L×W	Rated Voltage	TC Code	Capacitance												Capacitance Range	Page				
			pF					μF												
			0.1	1	10	100	1000	0.01	0.1	1	10	100	1000							
1.0×0.5mm	25Vdc	X7R																22000pF - 0.10μF	p105	
		X6S																1.0μF - 2.2μF	p105	
		X6T																2.2μF	p105	
		X5R																1.0μF - 2.2μF	p105	
		B																1.0μF	p105	
	16Vdc	X7R																	22000pF - 0.22μF	p105
		X7S																	1.0μF	p105
		X7T																	2.2μF	p105
		R																	22000pF - 47000pF	p105
		X6S																	1.0μF - 2.2μF	p105
		X6T																	2.2μF	p105
		X5R																	1.0μF - 2.2μF	p105
		B																	1.0μF	p106
	10Vdc	X7R																	47000pF - 0.47μF	p106
		X7S																	1.0μF - 2.2μF	p106
		X7T																	2.2μF	p106
		R																	47000pF	p106
		X6S																	1.0μF - 2.2μF	p106
		X5R																	1.0μF - 2.2μF	p106
		B																	1.0μF - 2.2μF	p106
		X7R																	1.0μF - 2.2μF	p106
	6.3Vdc	X7R																	22000pF - 1.0μF	p106
		X7S																	1.0μF - 2.2μF	p106
		X7T																	2.2μF	p106
X6S																		0.47μF - 4.7μF	p106	
X6T																		1.0μF - 2.2μF	p106	
X5R																		1.0μF - 2.2μF	p106	
B																		1.0μF - 4.7μF	p106	
4Vdc	X7R																	1.0μF	p106	
	X7S																	2.2μF	p106	
	X6S																	0.47μF - 2.2μF	p106	
	X6T																	1.0μF - 2.2μF	p106	
	X5R																	1.0μF - 10μF	p106	
	B																	1.0μF - 4.7μF	p106	
2.5Vdc	X6S																	2.2μF - 2.2μF	p106	
	X6T																	2.2μF - 4.7μF	p107	
	X5R																	4.7μF - 10μF	p107	
	X5S																	10μF	p107	
1.6×0.8mm	100Vdc	X7R																10000pF - 0.10μF	p107	
		X5R																0.22μF	p107	
	50Vdc	X7R																	2.2μF	p107
		X5R																	0.47μF	p107
	35Vdc	X7R																	2.2μF	p107
		X6S																	2.2μF - 10μF	p107
		X5R																	2.2μF	p107
		B																	0.22μF - 0.47μF	p107
	25Vdc	X7R																	2.2μF	p107
		X7S																	2.2μF - 4.7μF	p107
		X6S																	2.2μF - 10μF	p107
		X5R																	2.2μF	p107
		B																	2.2μF	p107
		X7R																	0.47μF	p107
	16Vdc	X7R																	2.2μF - 4.7μF	p107
		X7S																	2.2μF - 10μF	p107
		X6S																	4.7μF - 10μF	p107
		X5R																	4.7μF	p107
		B																		

Continued on the following page. ↗

Capacitance Table

(→ GRM Series High Dielectric Constant Type)

p00 ← Part Number List JIS: R B EIA: X7R X7S X7T X7U X6S X6T X5R X5S

L×W	Rated Voltage	TC Code	Capacitance										Capacitance Range	Page						
			pF					μF												
			0.1	1	10	100	1000	0.01	0.1	1	10	100			1000					
1.6×0.8mm	16Vdc	X7R															2.2μF - 4.7μF	p107		
		X7R																2.2μF	p107	
	10Vdc	X7S																4.7μF	p107	
		X7T																4.7μF - 10μF	p107	
		X6S																4.7μF - 10μF	p107	
		X5R																10μF - 22μF	p107	
		B																10μF	p107	
		X7R																4.7μF - 10μF	p107	
		6.3Vdc	X7R																2.2μF	p107
	X7S																	2.2μF	p107	
	X7T																	4.7μF - 10μF	p107	
	X6S																	4.7μF - 22μF	p107	
	X5R																	10μF - 47μF	p107 - p108	
	B																	10μF - 22μF	p108	
	4Vdc	X7S																2.2μF	p108	
		X6S																10μF - 47μF	p108	
		X5R																10μF - 47μF	p108	
		B																10μF - 22μF	p108	
	2.5Vdc	X6S																10μF - 47μF	p108	
		X5R																47μF	p108	
	1.8×1.0mm	16Vdc	X5R															20μF - 22μF	p108	
6.3Vdc		X5R															43μF	p108		
2.0×1.25mm	100Vdc	X7R																47000pF - 0.47μF	p108	
		X7S																1.0μF	p108	
		50Vdc	X7R																0.47μF	p108
			X7S																4.7μF	p108
			X6S																4.7μF	p108
			X5R																4.7μF - 10μF	p108
			B																4.7μF	p108
	X7R																4.7μF	p108		
	35Vdc	X7R																1.0μF	p108	
		X7S																4.7μF	p108	
		X6S																4.7μF - 10μF	p108	
		X5R																4.7μF - 10μF	p108	
		X7R																4.7μF	p108	
	25Vdc	X7R																2.2μF	p108	
		X7S																2.2μF - 10μF	p108	
		X6S																4.7μF - 10μF	p108	
		X5R																4.7μF - 22μF	p108	
		B																10μF	p108	
		X7R																4.7μF - 10μF	p108	
		16Vdc	X7R																4.7μF	p108
	X7S																	4.7μF - 10μF	p108	
	X6S																	4.7μF - 22μF	p108 - p109	
	X5R																	10μF - 22μF	p109	
	B																	10μF	p109	
	X7R																	10μF	p109	
	10Vdc		X7R																4.7μF - 10μF	p109
		X7T																22μF	p109	
		X6S																10μF - 22μF	p109	
		X5R																22μF - 47μF	p109	
		X7R																22μF	p109	
		6.3Vdc	X7R																10μF	p109
	X7T																	22μF	p109	
	X5R																	22μF - 100μF	p109	
B																	47μF	p109		

Continued on the following page. ↗

Capacitance Table

(→ GRM Series High Dielectric Constant Type)

p00 ← Part Number List JIS: R B EIA: X7R X7S X7T X7U X6S X6T X5R X5S

L×W	Rated Voltage	TC Code	Capacitance										Capacitance Range	Page					
			pF					μF											
			0.1	1	10	100	1000	0.01	0.1	1	10	100			1000				
2.0×1.25mm	6.3Vdc	X7R														22μF	p109		
	4Vdc	X7U															22μF	p109	
		X6S															47μF - 100μF	p109	
		X6T															47μF	p109	
		X5R															47μF - 100μF	p109	
		B															47μF	p109	
	2.5Vdc	X6S															100μF	p109	
		X6T															47μF	p109	
		X5R															100μF	p109	
3.2×1.6mm	100Vdc	X7S															4.7μF	p109	
		X7R															4.7μF	p109	
	50Vdc	X7R																4.7μF	p109
		X7T																10μF	p109
		X5R																4.7μF	p109
		B																4.7μF	p109
	35Vdc	X7T															10μF	p109	
	25Vdc	X7R																10μF	p109
		X7S																22μF	p109
		X6S																10μF - 22μF	p109
	16Vdc	X7S																22μF	p109
		X5R																22μF - 47μF	p109
		B																22μF	p109
		X7R																22μF	p109
	10Vdc	X7R																22μF	p109
		X6S																47μF	p109
		X5R																47μF - 100μF	p109
	6.3Vdc	X7R																22μF	p109
		X7S																22μF	p109
		X7U																47μF	p109
		X6T																100μF	p109
		X5R																47μF - 220μF	p109
	4Vdc	X7S																22μF	p109
		X7U																47μF - 100μF	p109
		X6S																220μF	p109
		X6T																47μF - 100μF	p109
		X5R																100μF - 220μF	p109
	2.5Vdc	X6S																220μF	p109
		X5R																220μF	p109
	3.2×2.5mm	100Vdc	X7S															10μF	p110
25Vdc		X7R																22μF	p110
		X6S																22μF	p110
16Vdc		X7R																22μF	p110
		X6S																47μF	p110
10Vdc		X7R																47μF	p110
		X7T																47μF	p110
		X6S																47μF	p110
		X5R																100μF	p110
6.3Vdc		X7R																47μF	p110
		X7S																100μF	p110
		X7U																100μF	p110
		X5R																220μF	p110
4Vdc		X7S																100μF	p110
		X7U																100μF	p110
		X6S																220μF	p110
		X5R																220μF - 330μF	p110
2.5Vdc		X6S															220μF - 330μF	p110	

Continued on the following page. ↗

Capacitance Table

(→ GRM Series High Dielectric Constant Type)

p00 ← Part Number List JIS: **R** **B** EIA: **X7R** **X7S** **X7T** **X7U** **X6S** **X6T** **X5R** **X5S**

L×W	Rated Voltage	TC Code	Capacitance											Capacitance Range	Page				
			pF					μF											
			0.1	1	10	100	1000	0.01	0.1	1	10	100	1000						
3.2×2.5mm	2.5Vdc	X5R																330μF	p110
4.5×3.2mm	1250Vdc	X7R																33000pF - 47000pF	p110
	1000Vdc	X7R																33000pF - 0.10μF	p110
	630Vdc	X7R																68000pF - 0.10μF	p110
	500Vdc	X7R																0.15μF - 0.22μF	p110
	250Vdc	X7R																0.15μF - 0.47μF	p110
5.7×5.0mm	1250Vdc	X7R																68000pF - 0.10μF	p110
	1000Vdc	X7R																68000pF - 0.22μF	p110
	630Vdc	X7R																0.15μF - 0.22μF	p110
	500Vdc	X7R																0.33μF - 0.47μF	p110
	250Vdc	X7R																0.33μF - 1.0μF	p110
	200Vdc	X7R																0.33μF - 1.0μF	p110

GR3 Series High Dielectric Constant Type

p00 ← Part Number List EIA: **X7T**

L×W	Rated Voltage	TC Code	Capacitance											Capacitance Range	Page				
			pF					μF											
			0.1	1	10	100	1000	0.01	0.1	1	10	100	1000						
2.0×1.25mm	250Vdc	X7T																10000pF - 22000pF	p112
3.2×1.6mm	630Vdc	X7T																10000pF - 15000pF	p112
	450Vdc	X7T																10000pF - 47000pF	p112
	250Vdc	X7T																33000pF - 68000pF	p112
3.2×2.5mm	630Vdc	X7T																22000pF - 47000pF	p112
	450Vdc	X7T																68000pF - 0.10μF	p112
	250Vdc	X7T																0.10μF - 0.15μF	p112
4.5×3.2mm	630Vdc	X7T																68000pF	p112
	450Vdc	X7T																0.15μF	p112
	250Vdc	X7T																0.22μF - 0.33μF	p112
5.7×5.0mm	630Vdc	X7T																0.10μF - 0.22μF	p112
	450Vdc	X7T																0.22μF - 0.47μF	p112
	250Vdc	X7T																0.47μF - 1.0μF	p112

GRJ Series High Dielectric Constant Type

p00 ← Part Number List EIA: **X7R** **X7S** **X5R**

L×W	Rated Voltage	TC Code	Capacitance											Capacitance Range	Page				
			pF					μF											
			0.1	1	10	100	1000	0.01	0.1	1	10	100	1000						
0.6×0.3mm	10Vdc	X5R																1.0μF	p114
	6.3Vdc	X5R																1.0μF	p114
1.0×0.5mm	6.3Vdc	X5R																10μF	p114
	1.6×0.8mm	10Vdc	X5R																10μF
6.3Vdc		X7S																4.7μF	p114
		X5R																	10μF
2.0×1.25mm	100Vdc	X7S																1.0μF	p114
	25Vdc	X5R																10μF	p114
3.2×1.6mm	100Vdc	X7S																4.7μF	p114
		X7R																4.7μF	p114
	50Vdc	X7R																4.7μF	p114
		X7S																	4.7μF
3.2×2.5mm	25Vdc	X7S																22μF	p114
	10Vdc	X7R																47μF	p114
4.5×3.2mm	1000Vdc	X7R																33000pF - 47000pF	p114

Continued on the following page. ↗

Capacitance Table

(→ GRJ Series High Dielectric Constant Type)

p00 ← Part Number List EIA: X7R X7S X5R

L×W	Rated Voltage	TC Code	Capacitance												Capacitance Range	Page			
			pF					μF											
			0.1	1	10	100	1000	0.01	0.1	1	10	100	1000						
4.5×3.2mm	630Vdc	X7R																68000pF - 0.10μF	p114
	250Vdc	X7R																0.15μF - 0.47μF	p114
5.7×5.0mm	1000Vdc	X7R																68000pF - 0.10μF	p114
	630Vdc	X7R																0.15μF - 0.22μF	p114
	250Vdc	X7R																0.33μF - 1.0μF	p114

GR4 Series Temperature Compensating Type

p00 ← Part Number List EIA: U2J

L×W	Rated Voltage	TC Code	Capacitance												Capacitance Range	Page			
			pF					μF											
			0.1	1	10	100	1000	0.01	0.1	1	10	100	1000						
3.2×1.6mm	630Vdc	U2J																1000pF - 4700pF	p116
3.2×2.5mm	630Vdc	U2J																5600pF - 15000pF	p116

GR4 Series High Dielectric Constant Type

p00 ← Part Number List EIA: X7R

L×W	Rated Voltage	TC Code	Capacitance												Capacitance Range	Page			
			pF					μF											
			0.1	1	10	100	1000	0.01	0.1	1	10	100	1000						
4.5×2.0mm	2000Vdc	X7R																100pF - 1500pF	p117
4.5×3.2mm	2000Vdc	X7R																1800pF - 4700pF	p117
5.7×5.0mm	2000Vdc	X7R																10000pF	p117

GJM Series Temperature Compensating Type

p00 ← Part Number List JIS: CK CJ CH CG EIA: COG Murata Temperature Characteristic: X8G

L×W	Rated Voltage	TC Code	Capacitance												Capacitance Range	Page			
			pF					μF											
			0.1	1	10	100	1000	0.01	0.1	1	10	100	1000						
0.4×0.2mm	25Vdc	COG																0.20pF - 22pF	p119 - p122
		CH																4.0pF - 22pF	p122 - p124
		CJ																2.1pF - 3.9pF	p124 - p125
		CK																0.20pF - 2.0pF	p125
		X8G																0.20pF - 22pF	p125 - p129
	16Vdc	COG																0.20pF - 22pF	p129 - p132
		CH																4.0pF - 22pF	p132 - p134
		CJ																2.1pF - 3.9pF	p134 - p135
		CK																0.20pF - 2.0pF	p135
		X8G																0.30pF - 15pF	p135 - p138
0.6×0.3mm	100Vdc	COG															0.30pF - 15pF	p138 - p141	
		CH															4.0pF - 15pF	p141	
		CJ															2.1pF - 3.9pF	p141	
		CK															0.30pF - 2.0pF	p141 - p145	
		X8G															0.30pF - 15pF	p145 - p148	
		COG															0.20pF - 15pF	p148 - p149	
		CH															4.0pF - 6.8pF	p149	
	50Vdc	CJ															2.2pF - 3.9pF	p149	
		CK															0.20pF - 2.0pF	p149 - p152	
		COG															0.20pF - 33pF	p152 - p155	
		CH															4.0pF - 33pF	p155	
		CJ															2.1pF - 3.9pF	p155 - p156	
		CK															0.20pF - 2.0pF		
		COG															0.20pF - 2.0pF		

Continued on the following page. ↗

Capacitance Table

(→ GJM Series Temperature Compensating Type)

p00 ← Part Number List JIS: **CK** **CJ** **CH** **CG** EIA: **COG** Murata Temperature Characteristic: **X8G**

L×W	Rated Voltage	TC Code	Capacitance										Capacitance Range	Page			
			pF					μF									
			0.1	1	10	100	1000	0.01	0.1	1	10	100			1000		
0.6×0.3mm	6.3Vdc	COG														22pF - 33pF	p156
		CH														22pF - 33pF	p156
1.0×0.5mm	50Vdc	COG														0.10pF - 47pF	p156 - p162
		CG														0.10pF - 47pF	p162 - p167
		CH														0.10pF - 47pF	p167 - p173
		CJ														2.1pF - 3.9pF	p173 - p174
		CK														0.10pF - 2.0pF	p174 - p175

GQM Series High Dielectric Constant Type

p00 ← Part Number List JIS: **CH** EIA: **COG** Murata Temperature Characteristic: **X8G**

L×W	Rated Voltage	TC Code	Capacitance										Capacitance Range	Page			
			pF					μF									
			0.1	1	10	100	1000	0.01	0.1	1	10	100			1000		
1.0×0.5mm	200Vdc	COG														0.10pF - 33pF	p177 - p180
		X8G														0.10pF - 33pF	p180 - p183
1.6×0.8mm	250Vdc	COG														0.10pF - 100pF	p183 - p187
		CH														11pF - 47pF	p187 - p188
		X8G														0.10pF - 30pF	p188 - p191
																0.20pF - 22pF	p191 - p195
2.0×1.25mm	500Vdc	X8G														0.20pF - 150pF	p195 - p199
	250Vdc	COG														0.20pF - 82pF	p199 - p204
		X8G														0.20pF - 82pF	p199 - p204
2.8×2.8mm	500Vdc	COG														0.30pF - 100pF	p204 - p208

GA2 Series High Dielectric Constant Type

p00 ← Part Number List EIA: **X7R**

L×W	Rated Voltage	TC Code	Capacitance										Capacitance Range	Page			
			pF					μF									
			0.1	1	10	100	1000	0.01	0.1	1	10	100			1000		
4.5×2.0mm	250Vac(r.m.s.)	X7R														470pF - 1000pF	p210
4.5×3.2mm	250Vac(r.m.s.)	X7R														2200pF - 47000pF	p210
5.7×5.0mm	250Vac(r.m.s.)	X7R														0.10μF	p210

GA3 Series Type GB High Dielectric Constant Type

p00 ← Part Number List EIA: **X7R**

L×W	Rated Voltage	TC Code	Capacitance										Capacitance Range	Page			
			pF					μF									
			0.1	1	10	100	1000	0.01	0.1	1	10	100			1000		
5.7×5.0mm	250Vac(r.m.s.)	X7R														10000pF - 56000pF	p213

GA3 Series Type GD Temperature Compensating Type

p00 ← Part Number List JIS: **SL**

L×W	Rated Voltage	TC Code	Capacitance										Capacitance Range	Page			
			pF					μF									
			0.1	1	10	100	1000	0.01	0.1	1	10	100			1000		
4.5×2.0mm	250Vac(r.m.s.)	SL														10pF - 82pF	p215

Capacitance Table

(→ LLL Series High Dielectric Constant Type)

p00 ← Part Number List EIA: X7R X7S X7T X6S X6T X5R

L×W	Rated Voltage	TC Code	Capacitance												Capacitance Range	Page			
			pF					μF											
			0.1	1	10	100	1000	0.01	0.1	1	10	100	1000						
1.6×3.2mm	25Vdc	X7R																22000pF - 0.47μF	p222
	16Vdc	X7R																22000pF - 1.0μF	p222 - p223
	10Vdc	X7R																0.47μF - 2.2μF	p223
	6.3Vdc	X7R																2.2μF - 4.7μF	p223
		X5R																10μF	p223

LLA Series High Dielectric Constant Type

p00 ← Part Number List EIA: X7R X7S X5R

L×W	Rated Voltage	TC Code	Capacitance												Capacitance Range	Page			
			pF					μF											
			0.1	1	10	100	1000	0.01	0.1	1	10	100	1000						
1.6×0.8mm	4Vdc	X7S																0.10μF - 2.2μF	p225
2.0×1.25mm	25Vdc	X7R																10000pF - 47000pF	p225
	16Vdc	X7R																47000pF - 0.22μF	p225
	10Vdc	X7R																47000pF - 0.47μF	p225
	6.3Vdc	X7R																0.22μF - 1.0μF	p225
		X5R																1.0μF	p225
4Vdc	X7R																22000pF - 1.0μF	p225	
	X7S																1.0μF - 4.7μF	p225	

LLM Series High Dielectric Constant Type

p00 ← Part Number List EIA: X7R X7S

L×W	Rated Voltage	TC Code	Capacitance												Capacitance Range	Page			
			pF					μF											
			0.1	1	10	100	1000	0.01	0.1	1	10	100	1000						
2.0×1.25mm	25Vdc	X7R																10000pF - 22000pF	p227
	16Vdc	X7R																47000pF - 0.10μF	p227
	6.3Vdc	X7R																0.22μF - 0.47μF	p227
	4Vdc	X7S																1.0μF	p227

LLR Series High Dielectric Constant Type

p00 ← Part Number List EIA: X7S

L×W	Rated Voltage	TC Code	ESR (mΩ)				Capacitance Range	Page
			100	220	470	1000		
0.8×1.6mm	4Vdc	X7S					1.0μF	p229

NFM Series

p00 ← Part Number List

L×W	Rated Voltage	TC Code	Capacitance												Capacitance Range	Page			
			pF					μF											
			0.1	1	10	100	1000	0.01	0.1	1	10	100	1000						
1.0×0.5mm	16Vdc	-																2200pF - 47000pF	p232
	10Vdc	-																2200pF - 0.22μF	p232
	6.3Vdc	-																0.10μF - 1.0μF	p232
	4Vdc	-																0.47μF - 14μF	p232
	2.5Vdc	-																4.3μF - 9.1μF	p232
1.2×0.9mm	4Vdc	-																15μF - 22μF	p232
	2.5Vdc	-																22μF	p232

Continued on the following page. ↗

Capacitance Table

(→ NFM Series)

p00 ← Part Number List

L×W	Rated Voltage	TC Code	Capacitance												Capacitance Range	Page		
			pF					μF										
			0.1	1	10	100	1000	0.01	0.1	1	10	100	1000					
1.6×0.8mm	16Vdc	-															100pF - 0.10μF	p232
	10Vdc	-															2.2μF	p232
	6.3Vdc	-															0.22μF - 10μF	p232
2.0×1.25mm	50Vdc	-															220pF - 2200pF	p232
	25Vdc	-															0.10μF	p232
	16Vdc	-															0.22μF - 1.0μF	p232
	10Vdc	-															1.0μF - 4.7μF	p232
3.2×1.25mm	50Vdc	-															220pF - 2200pF	p232
	6.3Vdc	-															2.2μF - 10μF	p232
3.2×1.6mm	100Vdc	-															1000pF - 0.10μF	p232
	50Vdc	-															1000pF - 0.10μF	p232
	6.3Vdc	-															27μF	p232
4.5×1.6mm	100Vdc	-															470pF - 22000pF	p232 - p233
	50Vdc	-															1.5μF	p233
	25Vdc	-															1.5μF	p233

GJ4 Series High Dielectric Constant Type

p00 ← Part Number List

JIS: R EIA: X6S

L×W	Rated Voltage	TC Code	Capacitance												Capacitance Range	Page		
			pF					μF										
			0.1	1	10	100	1000	0.01	0.1	1	10	100	1000					
2.0×1.25mm	25Vdc	X6S															0.10μF - 0.33μF	p236
3.2×1.6mm	100Vdc	X6S															0.10μF	p236
		R															0.10μF	p236
	25Vdc	X6S															0.47μF - 1.0μF	p236

ZRA Series High Dielectric Constant Type

p00 ← Part Number List

EIA: X5R

L×W	Rated Voltage	TC Code	Capacitance												Capacitance Range	Page		
			pF					μF										
			0.1	1	10	100	1000	0.01	0.1	1	10	100	1000					
2.4×1.65mm	25Vdc	X5R															22μF	p238
	16Vdc	X5R															22μF	p238
	6.3Vdc	X5R															47μF	p238
	4Vdc	X5R															47μF	p238

ZRB Series High Dielectric Constant Type

p00 ← Part Number List

EIA: X7T X6S X5R

L×W	Rated Voltage	TC Code	Capacitance												Capacitance Range	Page		
			pF					μF										
			0.1	1	10	100	1000	0.01	0.1	1	10	100	1000					
1.0×0.5mm	25Vdc	X5R															2.2μF	p240
		X6S															2.2μF	p240
	10Vdc	X5R															2.2μF	p240
		X6S															2.2μF	p240
		X5R															2.2μF - 10μF	p240
1.6×0.8mm	6.3Vdc	X5R															4.7μF - 10μF	p240
	35Vdc	X5R															4.7μF	p240
		X6S															4.7μF	p240
	25Vdc	X5R															10μF	p240

Continued on the following page. ↗

Capacitance Table

(→ ZRB Series High Dielectric Constant Type)

p00 ← Part Number List EIA: X7T X6S X5R

L×W	Rated Voltage	TC Code	Capacitance										Capacitance Range	Page				
			pF					μF										
			0.1	1	10	100	1000	0.01	0.1	1	10	100			1000			
1.6×0.8mm	16Vdc	X6S														10μF	p240	
		X5R															10μF	p240
	10Vdc	X7T															10μF	p240
		X6S															10μF	p240
		X5R															10μF - 22μF	p240
	6.3Vdc	X6S															10μF - 22μF	p240
X5R																22μF - 47μF	p240	
4Vdc	X6S															22μF	p240	
	X5R															22μF	p240	

KRM Series Temperature Compensating Type

p00 ← Part Number List EIA: COG U2J

L×W	Rated Voltage	TC Code	Capacitance										Capacitance Range	Page				
			pF					μF										
			0.1	1	10	100	1000	0.01	0.1	1	10	100			1000			
6.1×5.1mm	1250Vdc	U2J															8200pF - 10000pF	p243
	1000Vdc	U2J															8200pF - 0.020μF	p243
	630Vdc	COG															0.015μF - 0.054μF	p243
		U2J															33000pF - 94000pF	p243

KRM Series High Dielectric Constant Type

p00 ← Part Number List EIA: X7R X7S X6S X5R

L×W	Rated Voltage	TC Code	Capacitance										Capacitance Range	Page				
			pF					μF										
			0.1	1	10	100	1000	0.01	0.1	1	10	100			1000			
2.2×1.25mm	25Vdc	X7S															10μF	p244
		X6S															10μF	p244
		X5R															10μF - 22μF	p244
3.5×1.7mm	16Vdc	X5R															10μF	p244
	100Vdc	X7R															1.0μF	p244
		X7R															4.7μF	p244
		X6S															10μF	p244
		X5R															10μF	p244
3.6×1.7mm	50Vdc	X7R														2.2μF	p244	
3.7×1.85mm	100Vdc	X7R														2.2μF	p244	
6.1×5.3mm	1000Vdc	X7R															68000pF - 0.22μF	p244
	630Vdc	X7R															0.15μF - 0.47μF	p244
	450Vdc	X7R															0.33μF - 1.0μF	p244
	250Vdc	X7R															0.68μF - 2.2μF	p244
	100Vdc	X7R															4.7μF - 22μF	p244
	63Vdc	X7R															4.7μF - 22μF	p244
	50Vdc	X7R															4.7μF - 33μF	p244
	35Vdc	X7R															10μF - 47μF	p244
	25Vdc	X7R																15μF - 68μF
X7S																	47μF - 100μF	p244

Capacitance Table

KR3 Series High Dielectric Constant Type

p00 ← Part Number List EIA: X7T

L×W	Rated Voltage	TC Code	Capacitance											Capacitance Range	Page				
			pF					μF											
			0.1	1	10	100	1000	0.01	0.1	1	10	100	1000						
6.1×5.3mm	630Vdc	X7T																0.10μF - 0.56μF	p247
	450Vdc	X7T																0.22μF - 1.2μF	p247
	250Vdc	X7T																0.47μF - 2.2μF	p247

GMA Series High Dielectric Constant Type

p00 ← Part Number List JIS: R B EIA: X7R X6S X5R

L×W	Rated Voltage	TC Code	Capacitance											Capacitance Range	Page						
			pF					μF													
			0.1	1	10	100	1000	0.01	0.1	1	10	100	1000								
0.38×0.38mm	10Vdc	X7R																820pF - 10000pF	p250		
		R																820pF - 10000pF	p250		
		B																820pF - 10000pF	p250		
	6.3Vdc	X7R																10000pF	p250		
		R																10000pF	p250		
		B																10000pF	p250		
0.5×0.5mm	100Vdc	X7R																100pF - 1000pF	p250		
		R																100pF - 1000pF	p250		
		B																100pF - 1000pF	p250		
	50Vdc	X7R																	100pF - 1000pF	p250	
		R																	100pF - 1000pF	p250	
		B																	100pF - 1000pF	p250	
	25Vdc	X7R																	1500pF - 4700pF	p250	
		B																	1500pF - 4700pF	p250	
	16Vdc	X7R																	430pF - 4700pF	p250	
		R																	430pF - 4700pF	p250	
		B																	430pF - 4700pF	p250 - p251	
	10Vdc	X7R																	6800pF - 22000pF	p251	
			R																6800pF - 22000pF	p251	
			B																6800pF - 22000pF	p251	
		6.3Vdc	X7R																	6800pF - 22000pF	p251
			R																	6800pF - 22000pF	p251
			X6S																	47000pF - 0.10μF	p251
	X5R																		47000pF - 0.10μF	p251	
B																		6800pF - 0.10μF	p251		
0.8×0.8mm	100Vdc	X7R																330pF - 6800pF	p251		
		R																330pF - 6800pF	p251		
		B																330pF - 6800pF	p251		
	50Vdc	X7R																	330pF - 6800pF	p251	
		R																	330pF - 6800pF	p251	
		B																	330pF - 6800pF	p251	
	25Vdc	X7R																	10000pF - 22000pF	p251	
		B																	10000pF - 22000pF	p251 - p252	
	16Vdc	X7R																	1000pF - 22000pF	p252	
		R																	1000pF - 22000pF	p252	
		B																	1000pF - 22000pF	p252	
	10Vdc	X7R																	33000pF - 0.10μF	p252	
			R																33000pF - 0.10μF	p252	
			B																33000pF - 0.10μF	p252	
		6.3Vdc	X7R																	33000pF - 0.10μF	p252
			R																	33000pF - 0.10μF	p252
			X6S																	0.47μF	p252
	X5R																		0.47μF	p252	
B																		33000pF - 0.47μF	p252		

Capacitance Table

GMD Series High Dielectric Constant Type

p00 ← Part Number List JIS: R B EIA: X7R X5R

L×W	Rated Voltage	TC Code	Capacitance										Capacitance Range	Page			
			pF					μF									
			0.1	1	10	100	1000	0.01	0.1	1	10	100			1000		
0.6×0.3mm	25Vdc	X7R														100pF - 1500pF	p254
		R														100pF - 1500pF	p254
		B														100pF - 1500pF	p254
	16Vdc	X7R														1800pF - 3300pF	p254
		R														1800pF - 3300pF	p254
		B														1800pF - 3300pF	p255
	10Vdc	X7R														3900pF - 10000pF	p255
		R														3900pF - 10000pF	p255
		X5R														3900pF - 10000pF	p255
		B														3900pF - 10000pF	p255
	6.3Vdc	X5R														56000pF - 0.10μF	p255
		B														56000pF - 0.10μF	p255
1.0×0.5mm	50Vdc	X7R														220pF - 4700pF	p255
		R														220pF - 4700pF	p255 - p256
		B														220pF - 4700pF	p256
	25Vdc	X7R														5600pF - 47000pF	p256
		R														5600pF - 47000pF	p256
		B														5600pF - 47000pF	p256
	16Vdc	X7R														56000pF - 0.10μF	p256
		R														56000pF - 0.10μF	p256 - p257
		X5R														56000pF - 0.10μF	p257
	10Vdc	X5R														56000pF - 0.10μF	p257
		B														0.12μF - 0.47μF	p257
		X5R														0.12μF - 0.47μF	p257
	6.3Vdc	X5R														1.0μF	p257
		B														1.0μF	p257

Search Capacitors

Specifications and Test Methods, Package, Chart of Characteristic Data, please refer to the search web page.
<https://www.murata.com/en-global/products/capacitor>

Links are provided to the product detail pages on the web, and are shown below in the product number table from the PDF version of the catalog which is available on the web.

GRM Series Temperature Compensating

0.25×0.125mm

Rated Voltage	TC Code	Cap.	Tol.	Part Number
25Vdc	COG	0.20pF	±0.05pF	GRM0115C1ER20WE11#
			±0.1pF	GRM0115C1ER20BE11#
	0.30pF	±0.05pF	GRM0115C1ER30WE11#	
		±0.1pF	GRM0115C1ER30BE11#	
	0.40pF	±0.05pF	GRM0115C1ER40WE11#	
		±0.1pF	GRM0115C1ER40BE11#	
0.50pF	±0.05pF	GRM0115C1ER50WE11#		
	±0.1pF	GRM0115C1ER50BE11#		

The screenshot shows a detailed product page for the capacitor GRM0115C1ER20WE11#. The page is divided into several sections, each highlighted with a red dashed box and connected to an explanatory callout box on the right:

- Status and Features Icons:** A row of small icons representing different product features.
- Appearance & Shape:** Images showing the physical capacitor and its packaging.
- Specifications:** A table of technical specifications for the capacitor.
- References:** Links to related documents and resources.
- Characteristic Data:** A series of graphs showing the capacitor's performance characteristics under various conditions.

Status and Features Icons

The status and features of products can be checked at once. When ? is clicked, a description of each icon will be displayed

Stock Check (Where to buy)

Some products can request free samples. Reference inventory information from agents and web-based companies.

Data Sheet

The product details page can be output in PDF.

How to read part numbers

Describes the meaning of the part number

Series Information

This links to the introduction page of each series.

Detailed Specifications Sheet

- Rated value
- Specifications and Test Methods
- Package
- Caution, Notice (Storage, Soldering and Mounting,etc.)

Characteristics Data

- The following characteristics data of the main products can be acquired.
- SPICE Netlist (mod type)
 - S parameter (S2P type)
 - Reliability Test Data *Typical data
 - Shape (Dimensions)
 - Rated Values

Chart of Characteristic Data

- The main products published characteristic data.
- Frequency characteristics (ESR, Impedance)
 - DC bias characteristics
 - AC voltage characteristics
 - Capacitance - temperature characteristics
 - Calorific property by ripple current

Chip Multilayer Ceramic Capacitors for General Purpose

GRM Series



This is Murata primary products renowned for both small size and large capacitance value with latest advanced technology.

Features

① Achieves large-capacity and small size in a multilayer structure.

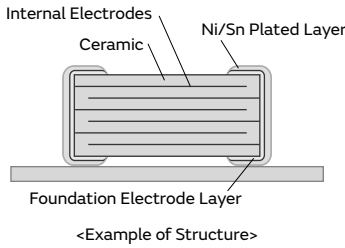

"Thin Layer Technology" for thinner layers

"Fine Particle Technology" for finer particles

"High Precision Lamination Technology" for more accuracy

② Sn plating is applied to the external electrodes; excellent solderability.

③ High reliability with no polarity.

	Ceramic Capacitors	Tantalum Capacitor	Aluminum Electrolytic Capacitor	Conductive Polymer Capacitor
Price	○	○	◎	○
Comparison between Impedance Frequency Characteristics	◎	△	△	○
Capacitance temperature characteristics	○	◎	○	○
DC breakdown voltage	◎	△	△	△
Polarity	No	Yes	Yes	Yes
Pulse response	◎	△	△	○
Allowable ripple current	◎	△	△	△
Reliability	◎	○	○	○
DC bias characteristics	△	◎	◎	◎

◎: Particularly excellent ○: Excellent △: Inferior

Specifications

Size (mm)	0.25×0.125mm to 5.7×5.0mm
Rated Voltage	2.5Vdc to 3150Vdc
Capacitance	0.10pF to 330µF
Main Applications	1. Rated voltage 100V Max. High Dielectric Constant Type . . . For decoupling and smoothing circuits Temperature Compensating Type . . . For tuning circuits, oscillating circuits, and high frequency filter circuits 2. Rated voltage 200V min. High Dielectric Constant Type . . . For clamp snubber circuits and smoothing circuits Temperature Compensating Type . . . Power supply damper snubber

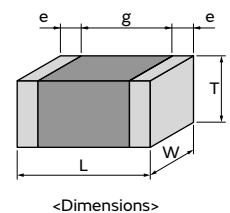

This catalog contains only a portion of the product lineup.
 Please refer to the capacitor search tool on the Murata Web site for details.

- GRM
- GR3
- GRJ
- GR4
- GJM
- GQM
- GA2
- GA3 GB
- GA3 GD
- GA3 GF
- LLL
- LLA
- LLM
- LLR
- NFM
- GJ4
- ZRA
- ZRB
- KRM
- KR3
- GMA
- GMD
- ⚠Caution /Notice

GRM Series Temperature Compensating Type Part Number List

0.25×0.125mm

Rated Voltage	TC Code	Cap.	Tol.	Part Number
25Vdc	COG	0.20pF	±0.05pF	GRM0115C1ER20WE11#
			±0.1pF	GRM0115C1ER20BE11#
		0.30pF	±0.05pF	GRM0115C1ER30WE11#
			±0.1pF	GRM0115C1ER30BE11#
		0.40pF	±0.05pF	GRM0115C1ER40WE11#
			±0.1pF	GRM0115C1ER40BE11#
		0.50pF	±0.05pF	GRM0115C1ER50WE11#
			±0.1pF	GRM0115C1ER50BE11#
		0.60pF	±0.05pF	GRM0115C1ER60WE11#
			±0.1pF	GRM0115C1ER60BE11#
		0.70pF	±0.05pF	GRM0115C1ER70WE11#
			±0.1pF	GRM0115C1ER70BE11#
		0.80pF	±0.05pF	GRM0115C1ER80WE11#
			±0.1pF	GRM0115C1ER80BE11#
		0.90pF	±0.05pF	GRM0115C1ER90WE11#
			±0.1pF	GRM0115C1ER90BE11#
		1.0pF	±0.05pF	GRM0115C1E1R0WE11#
			±0.1pF	GRM0115C1E1R0BE11#
			±0.25pF	GRM0115C1E1R0CE11#
		1.1pF	±0.05pF	GRM0115C1E1R1WE11#
			±0.1pF	GRM0115C1E1R1BE11#
			±0.25pF	GRM0115C1E1R1CE11#
		1.2pF	±0.05pF	GRM0115C1E1R2WE11#
			±0.1pF	GRM0115C1E1R2BE11#
			±0.25pF	GRM0115C1E1R2CE11#
		1.3pF	±0.05pF	GRM0115C1E1R3WE11#
			±0.1pF	GRM0115C1E1R3BE11#
			±0.25pF	GRM0115C1E1R3CE11#
		1.4pF	±0.05pF	GRM0115C1E1R4WE11#
			±0.1pF	GRM0115C1E1R4BE11#
			±0.25pF	GRM0115C1E1R4CE11#
		1.5pF	±0.05pF	GRM0115C1E1R5WE11#
			±0.1pF	GRM0115C1E1R5BE11#
			±0.25pF	GRM0115C1E1R5CE11#
		1.6pF	±0.05pF	GRM0115C1E1R6WE11#
			±0.1pF	GRM0115C1E1R6BE11#
			±0.25pF	GRM0115C1E1R6CE11#
		1.7pF	±0.05pF	GRM0115C1E1R7WE11#
			±0.1pF	GRM0115C1E1R7BE11#
			±0.25pF	GRM0115C1E1R7CE11#
		1.8pF	±0.05pF	GRM0115C1E1R8WE11#
			±0.1pF	GRM0115C1E1R8BE11#
			±0.25pF	GRM0115C1E1R8CE11#
		1.9pF	±0.05pF	GRM0115C1E1R9WE11#
			±0.1pF	GRM0115C1E1R9BE11#
			±0.25pF	GRM0115C1E1R9CE11#
		2.0pF	±0.05pF	GRM0115C1E2R0WE11#
			±0.1pF	GRM0115C1E2R0BE11#
±0.25pF	GRM0115C1E2R0CE11#			
2.1pF	±0.05pF	GRM0115C1E2R1WE11#		
	±0.1pF	GRM0115C1E2R1BE11#		
	±0.25pF	GRM0115C1E2R1CE11#		

Rated Voltage	TC Code	Cap.	Tol.	Part Number
25Vdc	COG	2.2pF	±0.05pF	GRM0115C1E2R2WE11#
			±0.1pF	GRM0115C1E2R2BE11#
			±0.25pF	GRM0115C1E2R2CE11#
		2.3pF	±0.05pF	GRM0115C1E2R3WE11#
			±0.1pF	GRM0115C1E2R3BE11#
			±0.25pF	GRM0115C1E2R3CE11#
		2.4pF	±0.05pF	GRM0115C1E2R4WE01#
			±0.1pF	GRM0115C1E2R4BE01#
			±0.25pF	GRM0115C1E2R4CE01#
		2.5pF	±0.05pF	GRM0115C1E2R5WE01#
			±0.1pF	GRM0115C1E2R5BE01#
			±0.25pF	GRM0115C1E2R5CE01#
		2.6pF	±0.05pF	GRM0115C1E2R6WE01#
			±0.1pF	GRM0115C1E2R6BE01#
			±0.25pF	GRM0115C1E2R6CE01#
		2.7pF	±0.05pF	GRM0115C1E2R7WE01#
			±0.1pF	GRM0115C1E2R7BE01#
			±0.25pF	GRM0115C1E2R7CE01#
		2.8pF	±0.05pF	GRM0115C1E2R8WE01#
			±0.1pF	GRM0115C1E2R8BE01#
			±0.25pF	GRM0115C1E2R8CE01#
		2.9pF	±0.05pF	GRM0115C1E2R9WE01#
			±0.1pF	GRM0115C1E2R9BE01#
			±0.25pF	GRM0115C1E2R9CE01#
		3.0pF	±0.05pF	GRM0115C1E3R0WE01#
			±0.1pF	GRM0115C1E3R0BE01#
			±0.25pF	GRM0115C1E3R0CE01#
		3.1pF	±0.05pF	GRM0115C1E3R1WE01#
			±0.1pF	GRM0115C1E3R1BE01#
			±0.25pF	GRM0115C1E3R1CE01#
		3.2pF	±0.05pF	GRM0115C1E3R2WE01#
			±0.1pF	GRM0115C1E3R2BE01#
			±0.25pF	GRM0115C1E3R2CE01#
		3.3pF	±0.05pF	GRM0115C1E3R3WE01#
			±0.1pF	GRM0115C1E3R3BE01#
			±0.25pF	GRM0115C1E3R3CE01#
		3.4pF	±0.05pF	GRM0115C1E3R4WE01#
			±0.1pF	GRM0115C1E3R4BE01#
			±0.25pF	GRM0115C1E3R4CE01#
		3.5pF	±0.05pF	GRM0115C1E3R5WE01#
			±0.1pF	GRM0115C1E3R5BE01#
			±0.25pF	GRM0115C1E3R5CE01#
		3.6pF	±0.05pF	GRM0115C1E3R6WE01#
			±0.1pF	GRM0115C1E3R6BE01#
			±0.25pF	GRM0115C1E3R6CE01#
		3.7pF	±0.05pF	GRM0115C1E3R7WE01#
			±0.1pF	GRM0115C1E3R7BE01#
			±0.25pF	GRM0115C1E3R7CE01#
3.8pF	±0.05pF	GRM0115C1E3R8WE01#		
	±0.1pF	GRM0115C1E3R8BE01#		
	±0.25pF	GRM0115C1E3R8CE01#		
3.9pF	±0.05pF	GRM0115C1E3R9WE01#		
	±0.1pF	GRM0115C1E3R9BE01#		
	±0.25pF	GRM0115C1E3R9CE01#		

- GRM
- GR3
- GRJ
- GR4
- GJM
- GQM
- GA2
- GA3 GB
- GA3 GD
- GA3 GF
- LLL
- LLA
- LLM
- LLR
- NFM
- GJ4
- ZRA
- ZRB
- KRM
- KR3
- GMA
- GMD
- △Caution /Notice

Part number # indicates the package specification code.

GRM Series Temperature Compensating Type Part Number List

(→ 0.25×0.125mm)

Rated Voltage	TC Code	Cap.	Tol.	Part Number	Rated Voltage	TC Code	Cap.	Tol.	Part Number	
25Vdc	COG	4.0pF	±0.05pF	GRM0115C1E4R0WE01#	25Vdc	COG	5.6pF	±0.1pF	GRM0115C1E5R6BE01#	
			±0.1pF	GRM0115C1E4R0BE01#				±0.25pF	GRM0115C1E5R6CE01#	
			±0.25pF	GRM0115C1E4R0CE01#				±0.5pF	GRM0115C1E5R6DE01#	
		4.1pF	±0.05pF	GRM0115C1E4R1WE01#			5.7pF	±0.05pF	GRM0115C1E5R7WE01#	
			±0.1pF	GRM0115C1E4R1BE01#				±0.1pF	GRM0115C1E5R7BE01#	
			±0.25pF	GRM0115C1E4R1CE01#				±0.25pF	GRM0115C1E5R7CE01#	
		4.2pF	±0.05pF	GRM0115C1E4R2WE01#			5.8pF	±0.5pF	GRM0115C1E5R7DE01#	
			±0.1pF	GRM0115C1E4R2BE01#				6.0pF	±0.05pF	GRM0115C1E6R0WE01#
			±0.25pF	GRM0115C1E4R2CE01#					±0.1pF	GRM0115C1E6R0BE01#
		4.3pF	±0.05pF	GRM0115C1E4R3WE01#			±0.25pF		GRM0115C1E6R0CE01#	
			±0.1pF	GRM0115C1E4R3BE01#			±0.5pF	GRM0115C1E6R0DE01#		
			±0.25pF	GRM0115C1E4R3CE01#			6.1pF	±0.05pF	GRM0115C1E6R1WE01#	
		4.4pF	±0.05pF	GRM0115C1E4R4WE01#				±0.1pF	GRM0115C1E6R1BE01#	
			±0.1pF	GRM0115C1E4R4BE01#				±0.25pF	GRM0115C1E6R1CE01#	
			±0.25pF	GRM0115C1E4R4CE01#			±0.5pF	GRM0115C1E6R1DE01#		
		4.5pF	±0.05pF	GRM0115C1E4R5WE01#			6.2pF	±0.05pF	GRM0115C1E6R2WE01#	
			±0.1pF	GRM0115C1E4R5BE01#				±0.1pF	GRM0115C1E6R2BE01#	
			±0.25pF	GRM0115C1E4R5CE01#				±0.25pF	GRM0115C1E6R2CE01#	
		4.6pF	±0.05pF	GRM0115C1E4R6WE01#			±0.5pF	GRM0115C1E6R2DE01#		
			±0.1pF	GRM0115C1E4R6BE01#			6.3pF	±0.05pF	GRM0115C1E6R3WE01#	
			±0.25pF	GRM0115C1E4R6CE01#				±0.1pF	GRM0115C1E6R3BE01#	
		±0.05pF	GRM0115C1E4R7WE01#	±0.25pF				GRM0115C1E6R3CE01#		
		4.7pF	±0.1pF	GRM0115C1E4R7BE01#			±0.5pF	GRM0115C1E6R3DE01#		
			±0.25pF	GRM0115C1E4R7CE01#			6.4pF	±0.05pF	GRM0115C1E6R4WE01#	
			±0.05pF	GRM0115C1E4R8WE01#				±0.1pF	GRM0115C1E6R4BE01#	
		±0.1pF	GRM0115C1E4R8BE01#	±0.25pF				GRM0115C1E6R4CE01#		
		±0.25pF	GRM0115C1E4R8CE01#	±0.5pF			GRM0115C1E6R4DE01#			
		4.9pF	±0.05pF	GRM0115C1E4R9WE01#			6.5pF	±0.05pF	GRM0115C1E6R5WE01#	
			±0.1pF	GRM0115C1E4R9BE01#				±0.1pF	GRM0115C1E6R5BE01#	
			±0.25pF	GRM0115C1E4R9CE01#				±0.25pF	GRM0115C1E6R5CE01#	
		5.0pF	±0.05pF	GRM0115C1E5R0WE01#			±0.5pF	GRM0115C1E6R5DE01#		
			±0.1pF	GRM0115C1E5R0BE01#			6.6pF	±0.05pF	GRM0115C1E6R6WE01#	
			±0.25pF	GRM0115C1E5R0CE01#				±0.1pF	GRM0115C1E6R6BE01#	
		±0.05pF	GRM0115C1E5R1WE01#	±0.25pF				GRM0115C1E6R6CE01#		
		5.1pF	±0.1pF	GRM0115C1E5R1BE01#			±0.5pF	GRM0115C1E6R6DE01#		
			±0.25pF	GRM0115C1E5R1CE01#			6.7pF	±0.05pF	GRM0115C1E6R7WE01#	
			±0.5pF	GRM0115C1E5R1DE01#				±0.1pF	GRM0115C1E6R7BE01#	
		±0.05pF	GRM0115C1E5R2WE01#	±0.25pF				GRM0115C1E6R7CE01#		
		5.2pF	±0.1pF	GRM0115C1E5R2BE01#			±0.5pF	GRM0115C1E6R7DE01#		
			±0.25pF	GRM0115C1E5R2CE01#			6.8pF	±0.05pF	GRM0115C1E6R8WE01#	
			±0.5pF	GRM0115C1E5R2DE01#				±0.1pF	GRM0115C1E6R8BE01#	
		±0.05pF	GRM0115C1E5R3WE01#	±0.25pF				GRM0115C1E6R8CE01#		
		5.3pF	±0.1pF	GRM0115C1E5R3BE01#			±0.5pF	GRM0115C1E6R8DE01#		
			±0.25pF	GRM0115C1E5R3CE01#			6.9pF	±0.05pF	GRM0115C1E6R9WE01#	
			±0.5pF	GRM0115C1E5R3DE01#				±0.1pF	GRM0115C1E6R9BE01#	
		±0.05pF	GRM0115C1E5R4WE01#	±0.25pF				GRM0115C1E6R9CE01#		
		5.4pF	±0.1pF	GRM0115C1E5R4BE01#						
			±0.25pF	GRM0115C1E5R4CE01#						
			±0.5pF	GRM0115C1E5R4DE01#						
		5.5pF	±0.05pF	GRM0115C1E5R5WE01#						
			±0.1pF	GRM0115C1E5R5BE01#						
			±0.25pF	GRM0115C1E5R5CE01#						
		±0.5pF	GRM0115C1E5R5DE01#							
		5.6pF	±0.05pF	GRM0115C1E5R6WE01#						

Part number # indicates the package specification code.

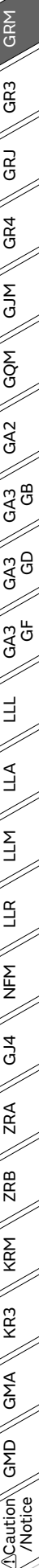

GRM Series Temperature Compensating Type Part Number List

(→ 0.25×0.125mm)

Rated Voltage	TC Code	Cap.	Tol.	Part Number	Rated Voltage	TC Code	Cap.	Tol.	Part Number		
25Vdc	COG	6.9pF	±0.5pF	GRM0115C1E6R9DE01#	25Vdc	COG	8.3pF	±0.1pF	GRM0115C1E8R3BE01#		
			±0.05pF	GRM0115C1E7R0WE01#				±0.25pF	GRM0115C1E8R3CE01#		
			±0.1pF	GRM0115C1E7R0BE01#				±0.5pF	GRM0115C1E8R3DE01#		
		7.0pF	±0.25pF	GRM0115C1E7R0CE01#			8.4pF	±0.05pF	GRM0115C1E8R4WE01#		
			±0.5pF	GRM0115C1E7R0DE01#				±0.1pF	GRM0115C1E8R4BE01#		
			±0.05pF	GRM0115C1E7R1WE01#				±0.25pF	GRM0115C1E8R4CE01#		
			±0.1pF	GRM0115C1E7R1BE01#				±0.5pF	GRM0115C1E8R4DE01#		
			±0.25pF	GRM0115C1E7R1CE01#				8.5pF	±0.05pF	GRM0115C1E8R5WE01#	
		±0.5pF	GRM0115C1E7R1DE01#	±0.1pF			GRM0115C1E8R5BE01#				
		±0.05pF	GRM0115C1E7R2WE01#	±0.25pF			GRM0115C1E8R5CE01#				
		7.2pF	±0.1pF	GRM0115C1E7R2BE01#			±0.5pF	GRM0115C1E8R5DE01#	8.6pF	±0.05pF	GRM0115C1E8R6WE01#
			±0.25pF	GRM0115C1E7R2CE01#			±0.1pF	GRM0115C1E8R6BE01#			
			±0.5pF	GRM0115C1E7R2DE01#			±0.25pF	GRM0115C1E8R6CE01#			
			±0.05pF	GRM0115C1E7R3WE01#			±0.5pF	GRM0115C1E8R6DE01#			
		7.3pF	±0.1pF	GRM0115C1E7R3BE01#			8.7pF	±0.05pF	GRM0115C1E8R7WE01#		
			±0.25pF	GRM0115C1E7R3CE01#				±0.1pF	GRM0115C1E8R7BE01#		
			±0.5pF	GRM0115C1E7R3DE01#				±0.25pF	GRM0115C1E8R7CE01#		
			±0.05pF	GRM0115C1E7R4WE01#				±0.5pF	GRM0115C1E8R7DE01#		
		7.4pF	±0.1pF	GRM0115C1E7R4BE01#			8.8pF	±0.05pF	GRM0115C1E8R8WE01#		
			±0.25pF	GRM0115C1E7R4CE01#				±0.1pF	GRM0115C1E8R8BE01#		
			±0.5pF	GRM0115C1E7R4DE01#				±0.25pF	GRM0115C1E8R8CE01#		
			±0.05pF	GRM0115C1E7R5WE01#				±0.5pF	GRM0115C1E8R8DE01#		
		7.5pF	±0.1pF	GRM0115C1E7R5BE01#			8.9pF	±0.05pF	GRM0115C1E8R9WE01#		
			±0.25pF	GRM0115C1E7R5CE01#				±0.1pF	GRM0115C1E8R9BE01#		
			±0.5pF	GRM0115C1E7R5DE01#				±0.25pF	GRM0115C1E8R9CE01#		
			±0.05pF	GRM0115C1E7R6WE01#				±0.5pF	GRM0115C1E8R9DE01#		
		7.6pF	±0.1pF	GRM0115C1E7R6BE01#			9.0pF	±0.05pF	GRM0115C1E9R0WE01#		
			±0.25pF	GRM0115C1E7R6CE01#				±0.1pF	GRM0115C1E9R0BE01#		
			±0.5pF	GRM0115C1E7R6DE01#				±0.25pF	GRM0115C1E9R0CE01#		
			±0.05pF	GRM0115C1E7R7WE01#				±0.5pF	GRM0115C1E9R0DE01#		
		7.7pF	±0.1pF	GRM0115C1E7R7BE01#			9.1pF	±0.05pF	GRM0115C1E9R1WE01#		
			±0.25pF	GRM0115C1E7R7CE01#				±0.1pF	GRM0115C1E9R1BE01#		
			±0.5pF	GRM0115C1E7R7DE01#				±0.25pF	GRM0115C1E9R1CE01#		
			±0.05pF	GRM0115C1E7R8WE01#				±0.5pF	GRM0115C1E9R1DE01#		
		7.8pF	±0.1pF	GRM0115C1E7R8BE01#			9.2pF	±0.05pF	GRM0115C1E9R2WE01#		
			±0.25pF	GRM0115C1E7R8CE01#				±0.1pF	GRM0115C1E9R2BE01#		
			±0.5pF	GRM0115C1E7R8DE01#				±0.25pF	GRM0115C1E9R2CE01#		
			±0.05pF	GRM0115C1E7R9WE01#				±0.5pF	GRM0115C1E9R2DE01#		
		7.9pF	±0.1pF	GRM0115C1E7R9BE01#			9.3pF	±0.05pF	GRM0115C1E9R3WE01#		
			±0.25pF	GRM0115C1E7R9CE01#				±0.1pF	GRM0115C1E9R3BE01#		
			±0.5pF	GRM0115C1E7R9DE01#				±0.25pF	GRM0115C1E9R3CE01#		
			±0.05pF	GRM0115C1E8R0WE01#				±0.5pF	GRM0115C1E9R3DE01#		
		8.0pF	±0.1pF	GRM0115C1E8R0BE01#			9.4pF	±0.05pF	GRM0115C1E9R4WE01#		
			±0.25pF	GRM0115C1E8R0CE01#				±0.1pF	GRM0115C1E9R4BE01#		
			±0.5pF	GRM0115C1E8R0DE01#				±0.25pF	GRM0115C1E9R4CE01#		
			±0.05pF	GRM0115C1E8R1WE01#				±0.5pF	GRM0115C1E9R4DE01#		
		8.1pF	±0.1pF	GRM0115C1E8R1BE01#			9.5pF	±0.05pF	GRM0115C1E9R5WE01#		
			±0.25pF	GRM0115C1E8R1CE01#				±0.1pF	GRM0115C1E9R5BE01#		
			±0.5pF	GRM0115C1E8R1DE01#				±0.25pF	GRM0115C1E9R5CE01#		
			±0.05pF	GRM0115C1E8R2WE01#				±0.5pF	GRM0115C1E9R5DE01#		
		8.2pF	±0.1pF	GRM0115C1E8R2BE01#			9.6pF	±0.05pF	GRM0115C1E9R6WE01#		
			±0.25pF	GRM0115C1E8R2CE01#				±0.1pF	GRM0115C1E9R6BE01#		
			±0.5pF	GRM0115C1E8R2DE01#				±0.25pF	GRM0115C1E9R6CE01#		
			±0.05pF	GRM0115C1E8R3WE01#							

- GRM
- GR3
- GRJ
- GR4
- GJM
- GQM
- GA2
- GA3 GB
- GA3 GD
- GA3 GF
- LLL
- LLA
- LLM
- LLR
- NFM
- GJ4
- ZRA
- ZRB
- KRM
- KR3
- GMA
- GMD
- ⚠Caution /Notice

Part number # indicates the package specification code.

GRM Series Temperature Compensating Type Part Number List

(→ 0.25×0.125mm)

Rated Voltage	TC Code	Cap.	Tol.	Part Number	Rated Voltage	TC Code	Cap.	Tol.	Part Number		
25Vdc	COG	9.6pF	±0.5pF	GRM0115C1E9R6DE01#	25Vdc	COG	68pF	±5%	GRM0115C1E680JE01#		
			±0.05pF	GRM0115C1E9R7WE01#				75pF	±2%	GRM0115C1E750GE01#	
			±0.1pF	GRM0115C1E9R7BE01#			±5%		GRM0115C1E750JE01#		
			±0.25pF	GRM0115C1E9R7CE01#			82pF	±2%	GRM0115C1E820GE01#		
			±0.5pF	GRM0115C1E9R7DE01#				±5%	GRM0115C1E820JE01#		
		9.8pF	±0.05pF	GRM0115C1E9R8WE01#			91pF	±2%	GRM0115C1E910GE01#		
			±0.1pF	GRM0115C1E9R8BE01#				±5%	GRM0115C1E910JE01#		
			±0.25pF	GRM0115C1E9R8CE01#			100pF	±2%	GRM0115C1E101GE01#		
			±0.5pF	GRM0115C1E9R8DE01#				±5%	GRM0115C1E101JE01#		
		9.9pF	±0.05pF	GRM0115C1E9R9WE01#			16Vdc	COG	0.20pF	±0.05pF	GRM0115C1CR20WE11#
			±0.1pF	GRM0115C1E9R9BE01#						±0.1pF	GRM0115C1CR20BE11#
			±0.25pF	GRM0115C1E9R9CE01#					0.30pF	±0.05pF	GRM0115C1CR30WE11#
			±0.5pF	GRM0115C1E9R9DE01#						±0.1pF	GRM0115C1CR30BE11#
		10pF	±2%	GRM0115C1E100GE01#					0.40pF	±0.05pF	GRM0115C1CR40WE11#
			±5%	GRM0115C1E100JE01#						±0.1pF	GRM0115C1CR40BE11#
		11pF	±2%	GRM0115C1E110GE01#					0.50pF	±0.05pF	GRM0115C1CR50WE11#
			±5%	GRM0115C1E110JE01#						±0.1pF	GRM0115C1CR50BE11#
		12pF	±2%	GRM0115C1E120GE01#					0.60pF	±0.05pF	GRM0115C1CR60WE11#
			±5%	GRM0115C1E120JE01#						±0.1pF	GRM0115C1CR60BE11#
		13pF	±2%	GRM0115C1E130GE01#					0.70pF	±0.05pF	GRM0115C1CR70WE11#
			±5%	GRM0115C1E130JE01#						±0.1pF	GRM0115C1CR70BE11#
		15pF	±2%	GRM0115C1E150GE01#					0.80pF	±0.05pF	GRM0115C1CR80WE11#
			±5%	GRM0115C1E150JE01#						±0.1pF	GRM0115C1CR80BE11#
		16pF	±2%	GRM0115C1E160GE01#					0.90pF	±0.05pF	GRM0115C1CR90WE11#
			±5%	GRM0115C1E160JE01#						±0.1pF	GRM0115C1CR90BE11#
		18pF	±2%	GRM0115C1E180GE01#					1.0pF	±0.05pF	GRM0115C1CR0WE11#
			±5%	GRM0115C1E180JE01#						±0.1pF	GRM0115C1CR0BE11#
		20pF	±2%	GRM0115C1E200GE01#						±0.25pF	GRM0115C1CR0CE11#
			±5%	GRM0115C1E200JE01#					1.1pF	±0.05pF	GRM0115C1CR1WE11#
		±2%	GRM0115C1E220GE01#	±0.1pF						GRM0115C1CR1BE11#	
		±5%	GRM0115C1E220JE01#	±0.25pF						GRM0115C1CR1CE11#	
		24pF	±2%	GRM0115C1E240GE01#					1.2pF	±0.05pF	GRM0115C1CR2WE11#
			±5%	GRM0115C1E240JE01#						±0.1pF	GRM0115C1CR2BE11#
		±2%	GRM0115C1E270GE01#	±0.25pF						GRM0115C1CR2CE11#	
		27pF	±2%	GRM0115C1E270JE01#					1.3pF	±0.05pF	GRM0115C1CR3WE11#
			±5%	GRM0115C1E270JE01#						±0.1pF	GRM0115C1CR3BE11#
		30pF	±2%	GRM0115C1E300GE01#						±0.25pF	GRM0115C1CR3CE11#
			±5%	GRM0115C1E300JE01#					1.4pF	±0.05pF	GRM0115C1CR4WE11#
			±2%	GRM0115C1E330GE01#						±0.1pF	GRM0115C1CR4BE11#
		±5%	GRM0115C1E330JE01#	±0.25pF						GRM0115C1CR4CE11#	
		36pF	±2%	GRM0115C1E360GE01#					1.5pF	±0.05pF	GRM0115C1CR5WE11#
			±5%	GRM0115C1E360JE01#						±0.1pF	GRM0115C1CR5BE11#
		±2%	GRM0115C1E390GE01#	±0.25pF						GRM0115C1CR5CE11#	
		39pF	±2%	GRM0115C1E390JE01#					1.6pF	±0.05pF	GRM0115C1CR6WE11#
			±5%	GRM0115C1E390JE01#						±0.1pF	GRM0115C1CR6BE11#
		43pF	±2%	GRM0115C1E430GE01#						±0.25pF	GRM0115C1CR6CE11#
			±5%	GRM0115C1E430JE01#					1.7pF	±0.05pF	GRM0115C1CR7WE11#
		±2%	GRM0115C1E470GE01#	±0.1pF						GRM0115C1CR7BE11#	
		±5%	GRM0115C1E470JE01#	±0.25pF						GRM0115C1CR7CE11#	
		51pF	±2%	GRM0115C1E510GE01#					1.8pF	±0.05pF	GRM0115C1CR8WE11#
			±5%	GRM0115C1E510JE01#						±0.1pF	GRM0115C1CR8BE11#
		±2%	GRM0115C1E560GE01#	±0.25pF						GRM0115C1CR8CE11#	
		56pF	±2%	GRM0115C1E560JE01#					1.9pF	±0.05pF	GRM0115C1CR9WE11#
			±5%	GRM0115C1E560JE01#						±0.1pF	GRM0115C1CR9BE11#
		62pF	±2%	GRM0115C1E620GE01#						±0.25pF	GRM0115C1CR9CE11#
			±5%	GRM0115C1E620JE01#					68pF	±2%	GRM0115C1E680GE01#
		±5%	GRM0115C1E620JE01#								

- GRM
- GR3
- GRJ
- GR4
- GJM
- GQM
- GA2
- GA3 GB
- GA3 GD
- GA3 GF
- LLL
- LLA
- LLM
- LLR
- NFM
- GJ4
- ZRA
- ZRB
- KRM
- KR3
- GMA
- GMD
- ⚠Caution /Notice

Part number # indicates the package specification code.

GRM Series Temperature Compensating Type Part Number List

(→ 0.25×0.125mm)

Rated Voltage	TC Code	Cap.	Tol.	Part Number	Rated Voltage	TC Code	Cap.	Tol.	Part Number		
16Vdc	COG	1.9pF	±0.25pF	GRM0115C1C1R9CE11#	16Vdc	COG	3.7pF	±0.25pF	GRM0115C1C3R7CE01#		
			2.0pF	±0.05pF				GRM0115C1C2R0WE11#	3.8pF	±0.05pF	GRM0115C1C3R8WE01#
				±0.1pF				GRM0115C1C2R0BE11#		±0.1pF	GRM0115C1C3R8BE01#
		±0.25pF		GRM0115C1C2R0CE11#			±0.25pF	GRM0115C1C3R8CE01#			
		2.1pF	±0.05pF	GRM0115C1C2R1WE11#			3.9pF	±0.05pF	GRM0115C1C3R9WE01#		
			±0.1pF	GRM0115C1C2R1BE11#				±0.1pF	GRM0115C1C3R9BE01#		
			±0.25pF	GRM0115C1C2R1CE11#				±0.25pF	GRM0115C1C3R9CE01#		
		2.2pF	±0.05pF	GRM0115C1C2R2WE11#			4.0pF	±0.05pF	GRM0115C1C4R0WE01#		
			±0.1pF	GRM0115C1C2R2BE11#				±0.1pF	GRM0115C1C4R0BE01#		
			±0.25pF	GRM0115C1C2R2CE11#				±0.25pF	GRM0115C1C4R0CE01#		
		2.3pF	±0.05pF	GRM0115C1C2R3WE11#			4.1pF	±0.05pF	GRM0115C1C4R1WE01#		
			±0.1pF	GRM0115C1C2R3BE11#				±0.1pF	GRM0115C1C4R1BE01#		
			±0.25pF	GRM0115C1C2R3CE11#				±0.25pF	GRM0115C1C4R1CE01#		
		2.4pF	±0.05pF	GRM0115C1C2R4WE01#			4.2pF	±0.05pF	GRM0115C1C4R2WE01#		
			±0.1pF	GRM0115C1C2R4BE01#				±0.1pF	GRM0115C1C4R2BE01#		
			±0.25pF	GRM0115C1C2R4CE01#				±0.25pF	GRM0115C1C4R2CE01#		
		2.5pF	±0.05pF	GRM0115C1C2R5WE01#			4.3pF	±0.05pF	GRM0115C1C4R3WE01#		
			±0.1pF	GRM0115C1C2R5BE01#				±0.1pF	GRM0115C1C4R3BE01#		
			±0.25pF	GRM0115C1C2R5CE01#				±0.25pF	GRM0115C1C4R3CE01#		
		2.6pF	±0.05pF	GRM0115C1C2R6WE01#			4.4pF	±0.05pF	GRM0115C1C4R4WE01#		
			±0.1pF	GRM0115C1C2R6BE01#				±0.1pF	GRM0115C1C4R4BE01#		
			±0.25pF	GRM0115C1C2R6CE01#				±0.25pF	GRM0115C1C4R4CE01#		
		2.7pF	±0.05pF	GRM0115C1C2R7WE01#			4.5pF	±0.05pF	GRM0115C1C4R5WE01#		
			±0.1pF	GRM0115C1C2R7BE01#				±0.1pF	GRM0115C1C4R5BE01#		
			±0.25pF	GRM0115C1C2R7CE01#				±0.25pF	GRM0115C1C4R5CE01#		
		2.8pF	±0.05pF	GRM0115C1C2R8WE01#			4.6pF	±0.05pF	GRM0115C1C4R6WE01#		
			±0.1pF	GRM0115C1C2R8BE01#				±0.1pF	GRM0115C1C4R6BE01#		
			±0.25pF	GRM0115C1C2R8CE01#				±0.25pF	GRM0115C1C4R6CE01#		
		2.9pF	±0.05pF	GRM0115C1C2R9WE01#			4.7pF	±0.05pF	GRM0115C1C4R7WE01#		
			±0.1pF	GRM0115C1C2R9BE01#				±0.1pF	GRM0115C1C4R7BE01#		
			±0.25pF	GRM0115C1C2R9CE01#				±0.25pF	GRM0115C1C4R7CE01#		
		3.0pF	±0.05pF	GRM0115C1C3R0WE01#			4.8pF	±0.05pF	GRM0115C1C4R8WE01#		
			±0.1pF	GRM0115C1C3R0BE01#				±0.1pF	GRM0115C1C4R8BE01#		
			±0.25pF	GRM0115C1C3R0CE01#				±0.25pF	GRM0115C1C4R8CE01#		
		3.1pF	±0.05pF	GRM0115C1C3R1WE01#			4.9pF	±0.05pF	GRM0115C1C4R9WE01#		
			±0.1pF	GRM0115C1C3R1BE01#				±0.1pF	GRM0115C1C4R9BE01#		
			±0.25pF	GRM0115C1C3R1CE01#				±0.25pF	GRM0115C1C4R9CE01#		
		3.2pF	±0.05pF	GRM0115C1C3R2WE01#			5.0pF	±0.05pF	GRM0115C1C5R0WE01#		
			±0.1pF	GRM0115C1C3R2BE01#				±0.1pF	GRM0115C1C5R0BE01#		
			±0.25pF	GRM0115C1C3R2CE01#				±0.25pF	GRM0115C1C5R0CE01#		
		3.3pF	±0.05pF	GRM0115C1C3R3WE01#			5.1pF	±0.05pF	GRM0115C1C5R1WE01#		
			±0.1pF	GRM0115C1C3R3BE01#				±0.1pF	GRM0115C1C5R1BE01#		
±0.25pF	GRM0115C1C3R3CE01#		±0.25pF	GRM0115C1C5R1CE01#							
3.4pF	±0.05pF	GRM0115C1C3R4WE01#	5.2pF	±0.05pF	GRM0115C1C5R2WE01#						
	±0.1pF	GRM0115C1C3R4BE01#		±0.1pF	GRM0115C1C5R2BE01#						
	±0.25pF	GRM0115C1C3R4CE01#		±0.25pF	GRM0115C1C5R2CE01#						
3.5pF	±0.05pF	GRM0115C1C3R5WE01#	5.3pF	±0.05pF	GRM0115C1C5R3WE01#						
	±0.1pF	GRM0115C1C3R5BE01#		±0.1pF	GRM0115C1C5R3BE01#						
	±0.25pF	GRM0115C1C3R5CE01#		±0.25pF	GRM0115C1C5R3CE01#						
3.6pF	±0.05pF	GRM0115C1C3R6WE01#	5.4pF	±0.05pF	GRM0115C1C5R4WE01#						
	±0.1pF	GRM0115C1C3R6BE01#		±0.1pF	GRM0115C1C5R4BE01#						
	±0.25pF	GRM0115C1C3R6CE01#		±0.25pF	GRM0115C1C5R4CE01#						
3.7pF	±0.05pF	GRM0115C1C3R7WE01#									
	±0.1pF	GRM0115C1C3R7BE01#									

Part number # indicates the package specification code.

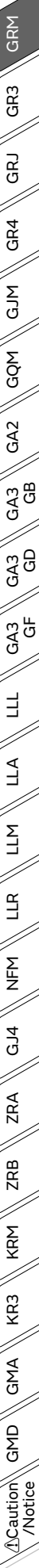

GRM Series Temperature Compensating Type Part Number List

(→ 0.25×0.125mm)

Rated Voltage	TC Code	Cap.	Tol.	Part Number	Rated Voltage	TC Code	Cap.	Tol.	Part Number
16Vdc	COG	5.4pF	±0.25pF	GRM0115C1C5R4CE01#	16Vdc	COG	6.8pF	±0.05pF	GRM0115C1C6R8WE01#
			±0.5pF	GRM0115C1C5R4DE01#				±0.1pF	GRM0115C1C6R8BE01#
		5.5pF	±0.05pF	GRM0115C1C5R5WE01#			±0.25pF	GRM0115C1C6R8CE01#	
			±0.1pF	GRM0115C1C5R5BE01#			±0.5pF	GRM0115C1C6R8DE01#	
			±0.25pF	GRM0115C1C5R5CE01#			6.9pF	±0.05pF	GRM0115C1C6R9WE01#
			±0.5pF	GRM0115C1C5R5DE01#				±0.1pF	GRM0115C1C6R9BE01#
		5.6pF	±0.05pF	GRM0115C1C5R6WE01#				±0.25pF	GRM0115C1C6R9CE01#
			±0.1pF	GRM0115C1C5R6BE01#			±0.5pF	GRM0115C1C6R9DE01#	
			±0.25pF	GRM0115C1C5R6CE01#			7.0pF	±0.05pF	GRM0115C1C7R0WE01#
		±0.5pF	GRM0115C1C5R6DE01#	±0.1pF				GRM0115C1C7R0BE01#	
		5.7pF	±0.05pF	GRM0115C1C5R7WE01#				±0.25pF	GRM0115C1C7R0CE01#
			±0.1pF	GRM0115C1C5R7BE01#			±0.5pF	GRM0115C1C7R0DE01#	
			±0.25pF	GRM0115C1C5R7CE01#			7.1pF	±0.05pF	GRM0115C1C7R1WE01#
			±0.5pF	GRM0115C1C5R7DE01#				±0.1pF	GRM0115C1C7R1BE01#
		5.8pF	±0.05pF	GRM0115C1C5R8WE01#				±0.25pF	GRM0115C1C7R1CE01#
			±0.1pF	GRM0115C1C5R8BE01#			±0.5pF	GRM0115C1C7R1DE01#	
			±0.25pF	GRM0115C1C5R8CE01#			7.2pF	±0.05pF	GRM0115C1C7R2WE01#
			±0.5pF	GRM0115C1C5R8DE01#				±0.1pF	GRM0115C1C7R2BE01#
		5.9pF	±0.05pF	GRM0115C1C5R9WE01#				±0.25pF	GRM0115C1C7R2CE01#
			±0.1pF	GRM0115C1C5R9BE01#			±0.5pF	GRM0115C1C7R2DE01#	
			±0.25pF	GRM0115C1C5R9CE01#			7.3pF	±0.05pF	GRM0115C1C7R3WE01#
			±0.5pF	GRM0115C1C5R9DE01#				±0.1pF	GRM0115C1C7R3BE01#
		6.0pF	±0.05pF	GRM0115C1C6R0WE01#				±0.25pF	GRM0115C1C7R3CE01#
			±0.1pF	GRM0115C1C6R0BE01#			±0.5pF	GRM0115C1C7R3DE01#	
			±0.25pF	GRM0115C1C6R0CE01#			7.4pF	±0.05pF	GRM0115C1C7R4WE01#
			±0.5pF	GRM0115C1C6R0DE01#				±0.1pF	GRM0115C1C7R4BE01#
		6.1pF	±0.05pF	GRM0115C1C6R1WE01#				±0.25pF	GRM0115C1C7R4CE01#
			±0.1pF	GRM0115C1C6R1BE01#			±0.5pF	GRM0115C1C7R4DE01#	
			±0.25pF	GRM0115C1C6R1CE01#			7.5pF	±0.05pF	GRM0115C1C7R5WE01#
			±0.5pF	GRM0115C1C6R1DE01#				±0.1pF	GRM0115C1C7R5BE01#
		6.2pF	±0.05pF	GRM0115C1C6R2WE01#				±0.25pF	GRM0115C1C7R5CE01#
			±0.1pF	GRM0115C1C6R2BE01#			±0.5pF	GRM0115C1C7R5DE01#	
			±0.25pF	GRM0115C1C6R2CE01#			7.6pF	±0.05pF	GRM0115C1C7R6WE01#
			±0.5pF	GRM0115C1C6R2DE01#				±0.1pF	GRM0115C1C7R6BE01#
		6.3pF	±0.05pF	GRM0115C1C6R3WE01#				±0.25pF	GRM0115C1C7R6CE01#
			±0.1pF	GRM0115C1C6R3BE01#			±0.5pF	GRM0115C1C7R6DE01#	
			±0.25pF	GRM0115C1C6R3CE01#			7.7pF	±0.05pF	GRM0115C1C7R7WE01#
			±0.5pF	GRM0115C1C6R3DE01#				±0.1pF	GRM0115C1C7R7BE01#
		6.4pF	±0.05pF	GRM0115C1C6R4WE01#				±0.25pF	GRM0115C1C7R7CE01#
			±0.1pF	GRM0115C1C6R4BE01#			±0.5pF	GRM0115C1C7R7DE01#	
			±0.25pF	GRM0115C1C6R4CE01#			7.8pF	±0.05pF	GRM0115C1C7R8WE01#
			±0.5pF	GRM0115C1C6R4DE01#				±0.1pF	GRM0115C1C7R8BE01#
		6.5pF	±0.05pF	GRM0115C1C6R5WE01#				±0.25pF	GRM0115C1C7R8CE01#
			±0.1pF	GRM0115C1C6R5BE01#			±0.5pF	GRM0115C1C7R8DE01#	
			±0.25pF	GRM0115C1C6R5CE01#			7.9pF	±0.05pF	GRM0115C1C7R9WE01#
			±0.5pF	GRM0115C1C6R5DE01#				±0.1pF	GRM0115C1C7R9BE01#
		6.6pF	±0.05pF	GRM0115C1C6R6WE01#				±0.25pF	GRM0115C1C7R9CE01#
			±0.1pF	GRM0115C1C6R6BE01#			±0.5pF	GRM0115C1C7R9DE01#	
			±0.25pF	GRM0115C1C6R6CE01#			8.0pF	±0.05pF	GRM0115C1C8R0WE01#
			±0.5pF	GRM0115C1C6R6DE01#				±0.1pF	GRM0115C1C8R0BE01#
		6.7pF	±0.05pF	GRM0115C1C6R7WE01#				±0.25pF	GRM0115C1C8R0CE01#
			±0.1pF	GRM0115C1C6R7BE01#			±0.5pF	GRM0115C1C8R0DE01#	
±0.25pF	GRM0115C1C6R7CE01#		8.1pF	±0.05pF	GRM0115C1C8R1WE01#				
±0.5pF	GRM0115C1C6R7DE01#			±0.1pF	GRM0115C1C8R1BE01#				

- GRM
- GR3
- GRJ
- GR4
- GJM
- GQM
- GQZ
- GA2
- GA3
- GA3
- GA3
- GA3
- LL
- LLA
- LLM
- LLR
- NFM
- GJ4
- ZRA
- ZRB
- KRM
- KR3
- GMA
- GMD
- △Caution / Notice

Part number # indicates the package specification code.

GRM Series Temperature Compensating Type Part Number List

(→ 0.25×0.125mm)

Rated Voltage	TC Code	Cap.	Tol.	Part Number	Rated Voltage	TC Code	Cap.	Tol.	Part Number
16Vdc	COG	8.1pF	±0.25pF	GRM0115C1C8R1CE01#	16Vdc	COG	9.5pF	±0.05pF	GRM0115C1C9R5WE01#
			±0.5pF	GRM0115C1C8R1DE01#				±0.1pF	GRM0115C1C9R5BE01#
		8.2pF	±0.05pF	GRM0115C1C8R2WE01#			±0.25pF	GRM0115C1C9R5CE01#	
			±0.1pF	GRM0115C1C8R2BE01#			±0.5pF	GRM0115C1C9R5DE01#	
			±0.25pF	GRM0115C1C8R2CE01#			9.6pF	±0.05pF	GRM0115C1C9R6WE01#
			±0.5pF	GRM0115C1C8R2DE01#				±0.1pF	GRM0115C1C9R6BE01#
		8.3pF	±0.05pF	GRM0115C1C8R3WE01#				±0.25pF	GRM0115C1C9R6CE01#
			±0.1pF	GRM0115C1C8R3BE01#			±0.5pF	GRM0115C1C9R6DE01#	
			±0.25pF	GRM0115C1C8R3CE01#			9.7pF	±0.05pF	GRM0115C1C9R7WE01#
		±0.5pF	GRM0115C1C8R3DE01#	±0.1pF				GRM0115C1C9R7BE01#	
		8.4pF	±0.05pF	GRM0115C1C8R4WE01#				±0.25pF	GRM0115C1C9R7CE01#
			±0.1pF	GRM0115C1C8R4BE01#			±0.5pF	GRM0115C1C9R7DE01#	
			±0.25pF	GRM0115C1C8R4CE01#			9.8pF	±0.05pF	GRM0115C1C9R8WE01#
			±0.5pF	GRM0115C1C8R4DE01#				±0.1pF	GRM0115C1C9R8BE01#
		8.5pF	±0.05pF	GRM0115C1C8R5WE01#				±0.25pF	GRM0115C1C9R8CE01#
			±0.1pF	GRM0115C1C8R5BE01#			±0.5pF	GRM0115C1C9R8DE01#	
			±0.25pF	GRM0115C1C8R5CE01#			9.9pF	±0.05pF	GRM0115C1C9R9WE01#
			±0.5pF	GRM0115C1C8R5DE01#				±0.1pF	GRM0115C1C9R9BE01#
		8.6pF	±0.05pF	GRM0115C1C8R6WE01#				±0.25pF	GRM0115C1C9R9CE01#
			±0.1pF	GRM0115C1C8R6BE01#			±0.5pF	GRM0115C1C9R9DE01#	
			±0.25pF	GRM0115C1C8R6CE01#			10pF	±2%	GRM0115C1C100GE01#
			±0.5pF	GRM0115C1C8R6DE01#				±5%	GRM0115C1C100JE01#
		8.7pF	±0.05pF	GRM0115C1C8R7WE01#			11pF	±2%	GRM0115C1C110GE01#
			±0.1pF	GRM0115C1C8R7BE01#				±5%	GRM0115C1C110JE01#
			±0.25pF	GRM0115C1C8R7CE01#			12pF	±2%	GRM0115C1C120GE01#
			±0.5pF	GRM0115C1C8R7DE01#				±5%	GRM0115C1C120JE01#
		8.8pF	±0.05pF	GRM0115C1C8R8WE01#			13pF	±2%	GRM0115C1C130GE01#
			±0.1pF	GRM0115C1C8R8BE01#				±5%	GRM0115C1C130JE01#
			±0.25pF	GRM0115C1C8R8CE01#			15pF	±2%	GRM0115C1C150GE01#
			±0.5pF	GRM0115C1C8R8DE01#				±5%	GRM0115C1C150JE01#
		8.9pF	±0.05pF	GRM0115C1C8R9WE01#			16pF	±2%	GRM0115C1C160GE01#
			±0.1pF	GRM0115C1C8R9BE01#				±5%	GRM0115C1C160JE01#
			±0.25pF	GRM0115C1C8R9CE01#			18pF	±2%	GRM0115C1C180GE01#
			±0.5pF	GRM0115C1C8R9DE01#				±5%	GRM0115C1C180JE01#
		9.0pF	±0.05pF	GRM0115C1C9R0WE01#			20pF	±2%	GRM0115C1C200GE01#
			±0.1pF	GRM0115C1C9R0BE01#				±5%	GRM0115C1C200JE01#
			±0.25pF	GRM0115C1C9R0CE01#			22pF	±2%	GRM0115C1C220GE01#
			±0.5pF	GRM0115C1C9R0DE01#				±5%	GRM0115C1C220JE01#
		9.1pF	±0.05pF	GRM0115C1C9R1WE01#			24pF	±2%	GRM0115C1C240GE01#
			±0.1pF	GRM0115C1C9R1BE01#				±5%	GRM0115C1C240JE01#
			±0.25pF	GRM0115C1C9R1CE01#			27pF	±2%	GRM0115C1C270GE01#
			±0.5pF	GRM0115C1C9R1DE01#				±5%	GRM0115C1C270JE01#
		9.2pF	±0.05pF	GRM0115C1C9R2WE01#			30pF	±2%	GRM0115C1C300GE01#
			±0.1pF	GRM0115C1C9R2BE01#				±5%	GRM0115C1C300JE01#
			±0.25pF	GRM0115C1C9R2CE01#			33pF	±2%	GRM0115C1C330GE01#
			±0.5pF	GRM0115C1C9R2DE01#				±5%	GRM0115C1C330JE01#
		9.3pF	±0.05pF	GRM0115C1C9R3WE01#			36pF	±2%	GRM0115C1C360GE01#
			±0.1pF	GRM0115C1C9R3BE01#				±5%	GRM0115C1C360JE01#
			±0.25pF	GRM0115C1C9R3CE01#			39pF	±2%	GRM0115C1C390GE01#
			±0.5pF	GRM0115C1C9R3DE01#				±5%	GRM0115C1C390JE01#
		9.4pF	±0.05pF	GRM0115C1C9R4WE01#			43pF	±2%	GRM0115C1C430GE01#
			±0.1pF	GRM0115C1C9R4BE01#				±5%	GRM0115C1C430JE01#
			±0.25pF	GRM0115C1C9R4CE01#			47pF	±2%	GRM0115C1C470GE01#
			±0.5pF	GRM0115C1C9R4DE01#				±5%	GRM0115C1C470JE01#



Part number # indicates the package specification code.

GRM Series Temperature Compensating Type Part Number List

(→ 0.25×0.125mm)

Rated Voltage	TC Code	Cap.	Tol.	Part Number
16Vdc	COG	51pF	±2%	GRM0115C1C510GE01#
			±5%	GRM0115C1C510JE01#
		56pF	±2%	GRM0115C1C560GE01#
			±5%	GRM0115C1C560JE01#
		62pF	±2%	GRM0115C1C620GE01#
			±5%	GRM0115C1C620JE01#
		68pF	±2%	GRM0115C1C680GE01#
			±5%	GRM0115C1C680JE01#
		75pF	±2%	GRM0115C1C750GE01#
			±5%	GRM0115C1C750JE01#
		82pF	±2%	GRM0115C1C820GE01#
			±5%	GRM0115C1C820JE01#
		91pF	±2%	GRM0115C1C910GE01#
			±5%	GRM0115C1C910JE01#
		100pF	±2%	GRM0115C1C101GE01#
			±5%	GRM0115C1C101JE01#

Rated Voltage	TC Code	Cap.	Tol.	Part Number
50Vdc	COG	1.5pF	±0.25pF	GRM0225C1H1R5CA03#
			±0.05pF	GRM0225C1H1R6WA03#
				±0.1pF
		1.6pF	±0.25pF	GRM0225C1H1R6CA03#
			±0.05pF	GRM0225C1H1R7WA03#
				±0.1pF
		1.7pF	±0.25pF	GRM0225C1H1R7CA03#
			±0.05pF	GRM0225C1H1R8WA03#
				±0.1pF
		1.8pF	±0.25pF	GRM0225C1H1R8CA03#
			±0.05pF	GRM0225C1H1R9WA03#
				±0.1pF
		1.9pF	±0.25pF	GRM0225C1H1R9CA03#
			±0.05pF	GRM0225C1H2R0WA03#
				±0.1pF
		2.0pF	±0.25pF	GRM0225C1H2R0CA03#
			±0.05pF	GRM0225C1H2R1WA03#
				±0.1pF
		2.1pF	±0.25pF	GRM0225C1H2R1CA03#
			±0.05pF	GRM0225C1H2R2WA03#
				±0.1pF
		2.2pF	±0.25pF	GRM0225C1H2R2CA03#
			±0.05pF	GRM0225C1H2R3WA03#
				±0.1pF
		2.3pF	±0.25pF	GRM0225C1H2R3CA03#
			±0.05pF	GRM0225C1H2R4WA03#
				±0.1pF
		2.4pF	±0.25pF	GRM0225C1H2R4CA03#
			±0.05pF	GRM0225C1H2R5WA03#
				±0.1pF
		2.5pF	±0.25pF	GRM0225C1H2R5CA03#
			±0.05pF	GRM0225C1H2R6WA03#
				±0.1pF
		2.6pF	±0.25pF	GRM0225C1H2R6CA03#
			±0.05pF	GRM0225C1H2R7WA03#
				±0.1pF
		2.7pF	±0.25pF	GRM0225C1H2R7CA03#
			±0.05pF	GRM0225C1H2R8WA03#
				±0.1pF
		2.8pF	±0.25pF	GRM0225C1H2R8CA03#
			±0.05pF	GRM0225C1H2R9WA03#
				±0.1pF
		2.9pF	±0.25pF	GRM0225C1H2R9CA03#
			±0.05pF	GRM0225C1H3R0WA03#
				±0.1pF
		3.0pF	±0.25pF	GRM0225C1H3R0CA03#
			±0.05pF	GRM0225C1H3R1WA03#
				±0.1pF
		3.1pF	±0.25pF	GRM0225C1H3R1CA03#
			±0.05pF	GRM0225C1H3R2WA03#
				±0.1pF
		3.2pF	±0.25pF	GRM0225C1H3R2CA03#
			±0.05pF	GRM0225C1H3R3WA03#
				±0.1pF
3.3pF	±0.25pF	GRM0225C1H3R3CA03#		

0.4×0.2mm

Rated Voltage	TC Code	Cap.	Tol.	Part Number
50Vdc	COG	0.20pF	±0.05pF	GRM0225C1HR20WA03#
			±0.1pF	GRM0225C1HR20BA03#
		0.30pF	±0.05pF	GRM0225C1HR30WA03#
			±0.1pF	GRM0225C1HR30BA03#
		0.40pF	±0.05pF	GRM0225C1HR40WA03#
			±0.1pF	GRM0225C1HR40BA03#
		0.50pF	±0.05pF	GRM0225C1HR50WA03#
			±0.1pF	GRM0225C1HR50BA03#
		0.60pF	±0.05pF	GRM0225C1HR60WA03#
			±0.1pF	GRM0225C1HR60BA03#
		0.70pF	±0.05pF	GRM0225C1HR70WA03#
			±0.1pF	GRM0225C1HR70BA03#
		0.80pF	±0.05pF	GRM0225C1HR80WA03#
			±0.1pF	GRM0225C1HR80BA03#
		0.90pF	±0.05pF	GRM0225C1HR90WA03#
			±0.1pF	GRM0225C1HR90BA03#
		1.0pF	±0.05pF	GRM0225C1H1R0WA03#
			±0.1pF	GRM0225C1H1R0BA03#
			±0.25pF	GRM0225C1H1R0CA03#
		1.1pF	±0.05pF	GRM0225C1H1R1WA03#
			±0.1pF	GRM0225C1H1R1BA03#
			±0.25pF	GRM0225C1H1R1CA03#
		1.2pF	±0.05pF	GRM0225C1H1R2WA03#
			±0.1pF	GRM0225C1H1R2BA03#
			±0.25pF	GRM0225C1H1R2CA03#
		1.3pF	±0.05pF	GRM0225C1H1R3WA03#
			±0.1pF	GRM0225C1H1R3BA03#
			±0.25pF	GRM0225C1H1R3CA03#
		1.4pF	±0.05pF	GRM0225C1H1R4WA03#
			±0.1pF	GRM0225C1H1R4BA03#
			±0.25pF	GRM0225C1H1R4CA03#
		1.5pF	±0.05pF	GRM0225C1H1R5WA03#
			±0.1pF	GRM0225C1H1R5BA03#

Part number # indicates the package specification code.



GRM Series Temperature Compensating Type Part Number List

(→ 0.4×0.2mm)

Rated Voltage	TC Code	Cap.	Tol.	Part Number	Rated Voltage	TC Code	Cap.	Tol.	Part Number		
50Vdc	COG	3.3pF	±0.25pF	GRM0225C1H3R3CA03#	50Vdc	COG	5.1pF	±0.25pF	GRM0225C1H5R1CA03#		
			±0.05pF	GRM0225C1H3R4WA03#				±0.5pF	GRM0225C1H5R1DA03#		
			±0.1pF	GRM0225C1H3R4BA03#				5.2pF	±0.05pF	GRM0225C1H5R2WA03#	
		±0.25pF	GRM0225C1H3R4CA03#	±0.1pF			GRM0225C1H5R2BA03#				
		3.5pF	±0.05pF	GRM0225C1H3R5WA03#			±0.25pF		GRM0225C1H5R2CA03#		
			±0.1pF	GRM0225C1H3R5BA03#			±0.5pF	GRM0225C1H5R2DA03#			
			±0.25pF	GRM0225C1H3R5CA03#			5.3pF	±0.05pF	GRM0225C1H5R3WA03#		
		3.6pF	±0.05pF	GRM0225C1H3R6WA03#				±0.1pF	GRM0225C1H5R3BA03#		
			±0.1pF	GRM0225C1H3R6BA03#				±0.25pF	GRM0225C1H5R3CA03#		
			±0.25pF	GRM0225C1H3R6CA03#			±0.5pF	GRM0225C1H5R3DA03#			
		3.7pF	±0.05pF	GRM0225C1H3R7WA03#			5.4pF	±0.05pF	GRM0225C1H5R4WA03#		
			±0.1pF	GRM0225C1H3R7BA03#				±0.1pF	GRM0225C1H5R4BA03#		
			±0.25pF	GRM0225C1H3R7CA03#				±0.25pF	GRM0225C1H5R4CA03#		
		3.8pF	±0.05pF	GRM0225C1H3R8WA03#			±0.5pF	GRM0225C1H5R4DA03#	5.5pF	±0.05pF	GRM0225C1H5R5WA03#
			±0.1pF	GRM0225C1H3R8BA03#			±0.1pF	GRM0225C1H5R5BA03#		±0.25pF	GRM0225C1H5R5CA03#
			±0.25pF	GRM0225C1H3R8CA03#			±0.5pF	GRM0225C1H5R5DA03#			
		3.9pF	±0.05pF	GRM0225C1H3R9WA03#			5.6pF	±0.05pF	GRM0225C1H5R6WA03#		
			±0.1pF	GRM0225C1H3R9BA03#				±0.1pF	GRM0225C1H5R6BA03#		
			±0.25pF	GRM0225C1H3R9CA03#				±0.25pF	GRM0225C1H5R6CA03#		
		4.0pF	±0.05pF	GRM0225C1H4R0WA03#			±0.5pF	GRM0225C1H5R6DA03#	5.7pF	±0.05pF	GRM0225C1H5R7WA03#
			±0.1pF	GRM0225C1H4R0BA03#			±0.1pF	GRM0225C1H5R7BA03#		±0.25pF	GRM0225C1H5R7CA03#
			±0.25pF	GRM0225C1H4R0CA03#			±0.5pF	GRM0225C1H5R7DA03#			
		4.1pF	±0.05pF	GRM0225C1H4R1WA03#			5.8pF	±0.05pF	GRM0225C1H5R8WA03#		
			±0.1pF	GRM0225C1H4R1BA03#				±0.1pF	GRM0225C1H5R8BA03#		
			±0.25pF	GRM0225C1H4R1CA03#				±0.25pF	GRM0225C1H5R8CA03#		
		4.2pF	±0.05pF	GRM0225C1H4R2WA03#			±0.5pF	GRM0225C1H5R8DA03#	5.9pF	±0.05pF	GRM0225C1H5R9WA03#
			±0.1pF	GRM0225C1H4R2BA03#			±0.1pF	GRM0225C1H5R9BA03#		±0.25pF	GRM0225C1H5R9CA03#
			±0.25pF	GRM0225C1H4R2CA03#			±0.5pF	GRM0225C1H5R9DA03#			
		4.3pF	±0.05pF	GRM0225C1H4R3WA03#			6.0pF	±0.05pF	GRM0225C1H6R0WA03#		
			±0.1pF	GRM0225C1H4R3BA03#				±0.1pF	GRM0225C1H6R0BA03#		
			±0.25pF	GRM0225C1H4R3CA03#				±0.25pF	GRM0225C1H6R0CA03#		
		4.4pF	±0.05pF	GRM0225C1H4R4WA03#			±0.5pF	GRM0225C1H6R0DA03#	6.1pF	±0.05pF	GRM0225C1H6R1WA03#
			±0.1pF	GRM0225C1H4R4BA03#			±0.1pF	GRM0225C1H6R1BA03#		±0.25pF	GRM0225C1H6R1CA03#
			±0.25pF	GRM0225C1H4R4CA03#			±0.5pF	GRM0225C1H6R1DA03#			
		4.5pF	±0.05pF	GRM0225C1H4R5WA03#			6.2pF	±0.05pF	GRM0225C1H6R2WA03#		
			±0.1pF	GRM0225C1H4R5BA03#				±0.1pF	GRM0225C1H6R2BA03#		
			±0.25pF	GRM0225C1H4R5CA03#				±0.25pF	GRM0225C1H6R2CA03#		
		4.6pF	±0.05pF	GRM0225C1H4R6WA03#			±0.5pF	GRM0225C1H6R2DA03#	6.3pF	±0.05pF	GRM0225C1H6R3WA03#
			±0.1pF	GRM0225C1H4R6BA03#			±0.1pF	GRM0225C1H6R3BA03#		±0.25pF	GRM0225C1H6R3CA03#
			±0.25pF	GRM0225C1H4R6CA03#			±0.5pF	GRM0225C1H6R3DA03#			
		4.7pF	±0.05pF	GRM0225C1H4R7WA03#			6.4pF	±0.05pF	GRM0225C1H6R4WA03#		
			±0.1pF	GRM0225C1H4R7BA03#				±0.1pF	GRM0225C1H6R4BA03#		
			±0.25pF	GRM0225C1H4R7CA03#				±0.25pF	GRM0225C1H6R4CA03#		
		4.8pF	±0.05pF	GRM0225C1H4R8WA03#			±0.5pF	GRM0225C1H6R4DA03#	5.0pF	±0.05pF	GRM0225C1H5R0WA03#
			±0.1pF	GRM0225C1H4R8BA03#			±0.1pF	GRM0225C1H5R0BA03#		±0.1pF	GRM0225C1H5R0BA03#
			±0.25pF	GRM0225C1H4R8CA03#			±0.25pF	GRM0225C1H5R0CA03#			
		4.9pF	±0.05pF	GRM0225C1H4R9WA03#			5.1pF	±0.05pF	GRM0225C1H5R1WA03#		
			±0.1pF	GRM0225C1H4R9BA03#				±0.1pF	GRM0225C1H5R1BA03#		
			±0.25pF	GRM0225C1H4R9CA03#							

- GRM
- GR3
- GRJ
- GR4
- GJM
- GQM
- GA2
- GA3 GB
- GA3 GD
- GA3 GF
- LLL
- LLA
- LLM
- LLR
- NFM
- GJ4
- ZRA
- ZRB
- KRM
- KR3
- GMA
- GMD
- ⚠Caution /Notice

Part number # indicates the package specification code.

GRM Series Temperature Compensating Type Part Number List

(→ 0.4×0.2mm)

Rated Voltage	TC Code	Cap.	Tol.	Part Number	Rated Voltage	TC Code	Cap.	Tol.	Part Number
50Vdc	COG	6.5pF	±0.05pF	GRM0225C1H6R5WA03#	50Vdc	COG	7.8pF	±0.25pF	GRM0225C1H7R8CA03#
			±0.1pF	GRM0225C1H6R5BA03#				±0.5pF	GRM0225C1H7R8DA03#
			±0.25pF	GRM0225C1H6R5CA03#			7.9pF	±0.05pF	GRM0225C1H7R9WA03#
			±0.5pF	GRM0225C1H6R5DA03#				±0.1pF	GRM0225C1H7R9BA03#
		6.6pF	±0.05pF	GRM0225C1H6R6WA03#				±0.25pF	GRM0225C1H7R9CA03#
			±0.1pF	GRM0225C1H6R6BA03#				±0.5pF	GRM0225C1H7R9DA03#
			±0.25pF	GRM0225C1H6R6CA03#			8.0pF	±0.05pF	GRM0225C1H8R0WA03#
			±0.5pF	GRM0225C1H6R6DA03#				±0.1pF	GRM0225C1H8R0BA03#
		6.7pF	±0.05pF	GRM0225C1H6R7WA03#				±0.25pF	GRM0225C1H8R0CA03#
			±0.1pF	GRM0225C1H6R7BA03#				±0.5pF	GRM0225C1H8R0DA03#
			±0.25pF	GRM0225C1H6R7CA03#			8.1pF	±0.05pF	GRM0225C1H8R1WA03#
			±0.5pF	GRM0225C1H6R7DA03#				±0.1pF	GRM0225C1H8R1BA03#
		6.8pF	±0.05pF	GRM0225C1H6R8WA03#				±0.25pF	GRM0225C1H8R1CA03#
			±0.1pF	GRM0225C1H6R8BA03#				±0.5pF	GRM0225C1H8R1DA03#
			±0.25pF	GRM0225C1H6R8CA03#			8.2pF	±0.05pF	GRM0225C1H8R2WA03#
			±0.5pF	GRM0225C1H6R8DA03#				±0.1pF	GRM0225C1H8R2BA03#
		6.9pF	±0.05pF	GRM0225C1H6R9WA03#				±0.25pF	GRM0225C1H8R2CA03#
			±0.1pF	GRM0225C1H6R9BA03#				±0.5pF	GRM0225C1H8R2DA03#
			±0.25pF	GRM0225C1H6R9CA03#			8.3pF	±0.05pF	GRM0225C1H8R3WA03#
			±0.5pF	GRM0225C1H6R9DA03#				±0.1pF	GRM0225C1H8R3BA03#
		7.0pF	±0.05pF	GRM0225C1H7R0WA03#				±0.25pF	GRM0225C1H8R3CA03#
			±0.1pF	GRM0225C1H7R0BA03#				±0.5pF	GRM0225C1H8R3DA03#
			±0.25pF	GRM0225C1H7R0CA03#			8.4pF	±0.05pF	GRM0225C1H8R4WA03#
			±0.5pF	GRM0225C1H7R0DA03#				±0.1pF	GRM0225C1H8R4BA03#
		7.1pF	±0.05pF	GRM0225C1H7R1WA03#				±0.25pF	GRM0225C1H8R4CA03#
			±0.1pF	GRM0225C1H7R1BA03#				±0.5pF	GRM0225C1H8R4DA03#
			±0.25pF	GRM0225C1H7R1CA03#			8.5pF	±0.05pF	GRM0225C1H8R5WA03#
			±0.5pF	GRM0225C1H7R1DA03#				±0.1pF	GRM0225C1H8R5BA03#
		7.2pF	±0.05pF	GRM0225C1H7R2WA03#				±0.25pF	GRM0225C1H8R5CA03#
			±0.1pF	GRM0225C1H7R2BA03#				±0.5pF	GRM0225C1H8R5DA03#
			±0.25pF	GRM0225C1H7R2CA03#			8.6pF	±0.05pF	GRM0225C1H8R6WA03#
			±0.5pF	GRM0225C1H7R2DA03#				±0.1pF	GRM0225C1H8R6BA03#
		7.3pF	±0.05pF	GRM0225C1H7R3WA03#				±0.25pF	GRM0225C1H8R6CA03#
			±0.1pF	GRM0225C1H7R3BA03#				±0.5pF	GRM0225C1H8R6DA03#
			±0.25pF	GRM0225C1H7R3CA03#			8.7pF	±0.05pF	GRM0225C1H8R7WA03#
			±0.5pF	GRM0225C1H7R3DA03#				±0.1pF	GRM0225C1H8R7BA03#
		7.4pF	±0.05pF	GRM0225C1H7R4WA03#				±0.25pF	GRM0225C1H8R7CA03#
			±0.1pF	GRM0225C1H7R4BA03#				±0.5pF	GRM0225C1H8R7DA03#
			±0.25pF	GRM0225C1H7R4CA03#			8.8pF	±0.05pF	GRM0225C1H8R8WA03#
			±0.5pF	GRM0225C1H7R4DA03#				±0.1pF	GRM0225C1H8R8BA03#
		7.5pF	±0.05pF	GRM0225C1H7R5WA03#				±0.25pF	GRM0225C1H8R8CA03#
			±0.1pF	GRM0225C1H7R5BA03#				±0.5pF	GRM0225C1H8R8DA03#
			±0.25pF	GRM0225C1H7R5CA03#			8.9pF	±0.05pF	GRM0225C1H8R9WA03#
			±0.5pF	GRM0225C1H7R5DA03#				±0.1pF	GRM0225C1H8R9BA03#
		7.6pF	±0.05pF	GRM0225C1H7R6WA03#				±0.25pF	GRM0225C1H8R9CA03#
			±0.1pF	GRM0225C1H7R6BA03#				±0.5pF	GRM0225C1H8R9DA03#
			±0.25pF	GRM0225C1H7R6CA03#			9.0pF	±0.05pF	GRM0225C1H9R0WA03#
			±0.5pF	GRM0225C1H7R6DA03#				±0.1pF	GRM0225C1H9R0BA03#
		7.7pF	±0.05pF	GRM0225C1H7R7WA03#				±0.25pF	GRM0225C1H9R0CA03#
			±0.1pF	GRM0225C1H7R7BA03#				±0.5pF	GRM0225C1H9R0DA03#
			±0.25pF	GRM0225C1H7R7CA03#			9.1pF	±0.05pF	GRM0225C1H9R1WA03#
			±0.5pF	GRM0225C1H7R7DA03#				±0.1pF	GRM0225C1H9R1BA03#
		7.8pF	±0.05pF	GRM0225C1H7R8WA03#				±0.25pF	GRM0225C1H9R1CA03#
			±0.1pF	GRM0225C1H7R8BA03#				±0.5pF	GRM0225C1H9R1DA03#

- GRM
- GR3
- GRJ
- GR4
- GJM
- GQM
- GA2
- GA3 GB
- GA3 GD
- GA3 GF
- LLL
- LLA
- LLM
- LLR
- NFM
- GJ4
- ZRA
- ZRB
- KRM
- KR3
- GMA
- GMD
- △Caution /Notice

Part number # indicates the package specification code.

GRM Series Temperature Compensating Type Part Number List

(→ 0.4×0.2mm)

Rated Voltage	TC Code	Cap.	Tol.	Part Number	Rated Voltage	TC Code	Cap.	Tol.	Part Number	
50Vdc	COG	9.2pF	±0.05pF	GRM0225C1H9R2WA03#	50Vdc	COG	30pF	±2%	GRM0225C1H300GA02#	
			±0.1pF	GRM0225C1H9R2BA03#				±5%	GRM0225C1H300JA02#	
			±0.25pF	GRM0225C1H9R2CA03#				33pF	±2%	GRM0225C1H330GA02#
			±0.5pF	GRM0225C1H9R2DA03#					±5%	GRM0225C1H330JA02#
		9.3pF	±0.05pF	GRM0225C1H9R3WA03#			36pF	±2%	GRM0225C1H360GA02#	
			±0.1pF	GRM0225C1H9R3BA03#				±5%	GRM0225C1H360JA02#	
			±0.25pF	GRM0225C1H9R3CA03#			39pF	±2%	GRM0225C1H390GA02#	
			±0.5pF	GRM0225C1H9R3DA03#				±5%	GRM0225C1H390JA02#	
		9.4pF	±0.05pF	GRM0225C1H9R4WA03#			43pF	±2%	GRM0225C1H430GA02#	
			±0.1pF	GRM0225C1H9R4BA03#				±5%	GRM0225C1H430JA02#	
			±0.25pF	GRM0225C1H9R4CA03#			47pF	±2%	GRM0225C1H470GA02#	
			±0.5pF	GRM0225C1H9R4DA03#				±5%	GRM0225C1H470JA02#	
		9.5pF	±0.05pF	GRM0225C1H9R5WA03#			51pF	±2%	GRM0225C1H510GA02#	
			±0.1pF	GRM0225C1H9R5BA03#				±5%	GRM0225C1H510JA02#	
			±0.25pF	GRM0225C1H9R5CA03#			56pF	±2%	GRM0225C1H560GA02#	
			±0.5pF	GRM0225C1H9R5DA03#				±5%	GRM0225C1H560JA02#	
		9.6pF	±0.05pF	GRM0225C1H9R6WA03#			62pF	±2%	GRM0225C1H620GA02#	
			±0.1pF	GRM0225C1H9R6BA03#				±5%	GRM0225C1H620JA02#	
			±0.25pF	GRM0225C1H9R6CA03#			68pF	±2%	GRM0225C1H680GA02#	
			±0.5pF	GRM0225C1H9R6DA03#				±5%	GRM0225C1H680JA02#	
		9.7pF	±0.05pF	GRM0225C1H9R7WA03#			75pF	±2%	GRM0225C1H750GA02#	
			±0.1pF	GRM0225C1H9R7BA03#				±5%	GRM0225C1H750JA02#	
			±0.25pF	GRM0225C1H9R7CA03#			82pF	±2%	GRM0225C1H820GA02#	
			±0.5pF	GRM0225C1H9R7DA03#				±5%	GRM0225C1H820JA02#	
		9.8pF	±0.05pF	GRM0225C1H9R8WA03#			91pF	±2%	GRM0225C1H910GA02#	
			±0.1pF	GRM0225C1H9R8BA03#				±5%	GRM0225C1H910JA02#	
			±0.25pF	GRM0225C1H9R8CA03#			100pF	±2%	GRM0225C1H101GA02#	
			±0.5pF	GRM0225C1H9R8DA03#				±5%	GRM0225C1H101JA02#	
		9.9pF	±0.05pF	GRM0225C1H9R9WA03#			CH	4.0pF	±0.05pF	GRM0222C1H4R0WA03#
			±0.1pF	GRM0225C1H9R9BA03#					±0.1pF	GRM0222C1H4R0BA03#
			±0.25pF	GRM0225C1H9R9CA03#					±0.25pF	GRM0222C1H4R0CA03#
			±0.5pF	GRM0225C1H9R9DA03#				4.1pF	±0.05pF	GRM0222C1H4R1WA03#
		10pF	±2%	GRM0225C1H100GA03#					±0.1pF	GRM0222C1H4R1BA03#
			±5%	GRM0225C1H100JA03#					±0.25pF	GRM0222C1H4R1CA03#
		11pF	±2%	GRM0225C1H110GA03#				4.2pF	±0.05pF	GRM0222C1H4R2WA03#
			±5%	GRM0225C1H110JA03#					±0.1pF	GRM0222C1H4R2BA03#
		12pF	±2%	GRM0225C1H120GA03#				4.3pF	±0.25pF	GRM0222C1H4R2CA03#
			±5%	GRM0225C1H120JA03#					±0.05pF	GRM0222C1H4R3WA03#
		13pF	±2%	GRM0225C1H130GA03#					±0.1pF	GRM0222C1H4R3BA03#
			±5%	GRM0225C1H130JA03#				±0.25pF	GRM0222C1H4R3CA03#	
			15pF	±2%				GRM0225C1H150GA03#	4.4pF	±0.05pF
		±5%		GRM0225C1H150JA03#				±0.1pF		GRM0222C1H4R4BA03#
		16pF	±2%	GRM0225C1H160GA03#				±0.25pF		GRM0222C1H4R4CA03#
			±5%	GRM0225C1H160JA03#				4.5pF	±0.05pF	GRM0222C1H4R5WA03#
		18pF	±2%	GRM0225C1H180GA02#					±0.1pF	GRM0222C1H4R5BA03#
			±5%	GRM0225C1H180JA02#					±0.25pF	GRM0222C1H4R5CA03#
		20pF	±2%	GRM0225C1H200GA02#				4.6pF	±0.05pF	GRM0222C1H4R6WA03#
			±5%	GRM0225C1H200JA02#					±0.1pF	GRM0222C1H4R6BA03#
		22pF	±2%	GRM0225C1H220GA02#					±0.25pF	GRM0222C1H4R6CA03#
			±5%	GRM0225C1H220JA02#				4.7pF	±0.05pF	GRM0222C1H4R7WA03#
		24pF	±2%	GRM0225C1H240GA02#					±0.1pF	GRM0222C1H4R7BA03#
			±5%	GRM0225C1H240JA02#					±0.25pF	GRM0222C1H4R7CA03#
27pF	±2%	GRM0225C1H270GA02#	4.8pF	±0.05pF	GRM0222C1H4R8WA03#					
	±5%	GRM0225C1H270JA02#		±0.1pF	GRM0222C1H4R8BA03#					

Part number # indicates the package specification code.

GRM
 GR3
 GRJ
 GR4
 GJM
 GQM
 GA2
 GA3 GB
 GA3 GD
 GA3 GF
 LLL
 LLA
 LLM
 LLR
 NFM
 GJ4
 ZRA
 ZRB
 KRM
 KR3
 GMA
 GMD
 ⚠Caution /Notice

GRM Series Temperature Compensating Type Part Number List

(→ 0.4×0.2mm)

Rated Voltage	TC Code	Cap.	Tol.	Part Number	Rated Voltage	TC Code	Cap.	Tol.	Part Number	
50Vdc	CH	4.8pF	±0.25pF	GRM0222C1H4R8CA03#	50Vdc	CH	6.2pF	±0.5pF	GRM0222C1H6R2DA03#	
			±0.05pF	GRM0222C1H4R9WA03#				6.3pF	±0.05pF	GRM0222C1H6R3WA03#
			±0.1pF	GRM0222C1H4R9BA03#					±0.1pF	GRM0222C1H6R3BA03#
		±0.25pF	GRM0222C1H4R9CA03#	±0.25pF			GRM0222C1H6R3CA03#			
		5.0pF	±0.05pF	GRM0222C1H5R0WA03#			6.4pF	±0.05pF	GRM0222C1H6R4WA03#	
			±0.1pF	GRM0222C1H5R0BA03#				±0.1pF	GRM0222C1H6R4BA03#	
			±0.25pF	GRM0222C1H5R0CA03#				±0.25pF	GRM0222C1H6R4CA03#	
		5.1pF	±0.05pF	GRM0222C1H5R1WA03#			6.5pF	±0.05pF	GRM0222C1H6R5WA03#	
			±0.1pF	GRM0222C1H5R1BA03#				±0.1pF	GRM0222C1H6R5BA03#	
			±0.25pF	GRM0222C1H5R1CA03#				±0.25pF	GRM0222C1H6R5CA03#	
			±0.5pF	GRM0222C1H5R1DA03#				±0.5pF	GRM0222C1H6R5DA03#	
		5.2pF	±0.05pF	GRM0222C1H5R2WA03#			6.6pF	±0.05pF	GRM0222C1H6R6WA03#	
			±0.1pF	GRM0222C1H5R2BA03#				±0.1pF	GRM0222C1H6R6BA03#	
			±0.25pF	GRM0222C1H5R2CA03#				±0.25pF	GRM0222C1H6R6CA03#	
			±0.5pF	GRM0222C1H5R2DA03#				±0.5pF	GRM0222C1H6R6DA03#	
		5.3pF	±0.05pF	GRM0222C1H5R3WA03#			6.7pF	±0.05pF	GRM0222C1H6R7WA03#	
			±0.1pF	GRM0222C1H5R3BA03#				±0.1pF	GRM0222C1H6R7BA03#	
			±0.25pF	GRM0222C1H5R3CA03#				±0.25pF	GRM0222C1H6R7CA03#	
			±0.5pF	GRM0222C1H5R3DA03#				±0.5pF	GRM0222C1H6R7DA03#	
		5.4pF	±0.05pF	GRM0222C1H5R4WA03#			6.8pF	±0.05pF	GRM0222C1H6R8WA03#	
			±0.1pF	GRM0222C1H5R4BA03#				±0.1pF	GRM0222C1H6R8BA03#	
			±0.25pF	GRM0222C1H5R4CA03#				±0.25pF	GRM0222C1H6R8CA03#	
			±0.5pF	GRM0222C1H5R4DA03#				±0.5pF	GRM0222C1H6R8DA03#	
		5.5pF	±0.05pF	GRM0222C1H5R5WA03#			6.9pF	±0.05pF	GRM0222C1H6R9WA03#	
			±0.1pF	GRM0222C1H5R5BA03#				±0.1pF	GRM0222C1H6R9BA03#	
			±0.25pF	GRM0222C1H5R5CA03#				±0.25pF	GRM0222C1H6R9CA03#	
			±0.5pF	GRM0222C1H5R5DA03#				±0.5pF	GRM0222C1H6R9DA03#	
		5.6pF	±0.05pF	GRM0222C1H5R6WA03#			7.0pF	±0.05pF	GRM0222C1H7R0WA03#	
			±0.1pF	GRM0222C1H5R6BA03#				±0.1pF	GRM0222C1H7R0BA03#	
			±0.25pF	GRM0222C1H5R6CA03#				±0.25pF	GRM0222C1H7R0CA03#	
			±0.5pF	GRM0222C1H5R6DA03#				±0.5pF	GRM0222C1H7R0DA03#	
		5.7pF	±0.05pF	GRM0222C1H5R7WA03#			7.1pF	±0.05pF	GRM0222C1H7R1WA03#	
			±0.1pF	GRM0222C1H5R7BA03#				±0.1pF	GRM0222C1H7R1BA03#	
			±0.25pF	GRM0222C1H5R7CA03#				±0.25pF	GRM0222C1H7R1CA03#	
			±0.5pF	GRM0222C1H5R7DA03#				±0.5pF	GRM0222C1H7R1DA03#	
		5.8pF	±0.05pF	GRM0222C1H5R8WA03#			7.2pF	±0.05pF	GRM0222C1H7R2WA03#	
			±0.1pF	GRM0222C1H5R8BA03#				±0.1pF	GRM0222C1H7R2BA03#	
			±0.25pF	GRM0222C1H5R8CA03#				±0.25pF	GRM0222C1H7R2CA03#	
			±0.5pF	GRM0222C1H5R8DA03#				±0.5pF	GRM0222C1H7R2DA03#	
		5.9pF	±0.05pF	GRM0222C1H5R9WA03#			7.3pF	±0.05pF	GRM0222C1H7R3WA03#	
			±0.1pF	GRM0222C1H5R9BA03#				±0.1pF	GRM0222C1H7R3BA03#	
			±0.25pF	GRM0222C1H5R9CA03#				±0.25pF	GRM0222C1H7R3CA03#	
			±0.5pF	GRM0222C1H5R9DA03#				±0.5pF	GRM0222C1H7R3DA03#	
		6.0pF	±0.05pF	GRM0222C1H6R0WA03#			7.4pF	±0.05pF	GRM0222C1H7R4WA03#	
			±0.1pF	GRM0222C1H6R0BA03#				±0.1pF	GRM0222C1H7R4BA03#	
			±0.25pF	GRM0222C1H6R0CA03#				±0.25pF	GRM0222C1H7R4CA03#	
			±0.5pF	GRM0222C1H6R0DA03#				±0.5pF	GRM0222C1H7R4DA03#	
		6.1pF	±0.05pF	GRM0222C1H6R1WA03#			7.5pF	±0.05pF	GRM0222C1H7R5WA03#	
			±0.1pF	GRM0222C1H6R1BA03#				±0.1pF	GRM0222C1H7R5BA03#	
			±0.25pF	GRM0222C1H6R1CA03#				±0.25pF	GRM0222C1H7R5CA03#	
			±0.5pF	GRM0222C1H6R1DA03#				±0.5pF	GRM0222C1H7R5DA03#	
		6.2pF	±0.05pF	GRM0222C1H6R2WA03#			7.6pF	±0.05pF	GRM0222C1H7R6WA03#	
±0.1pF	GRM0222C1H6R2BA03#									
±0.25pF	GRM0222C1H6R2CA03#									

Part number # indicates the package specification code.

GRM
 GR3
 GRJ
 GR4
 GJM
 GQM
 GA2
 GA3 GB
 GA3 GD
 GA3 GF
 LLL
 LLA
 LLM
 LLR
 NFM
 GJ4
 ZRA
 ZRB
 KRM
 KR3
 GMA
 GMD
 △Caution /Notice

GRM Series Temperature Compensating Type Part Number List

(→ 0.4×0.2mm)

Rated Voltage	TC Code	Cap.	Tol.	Part Number	Rated Voltage	TC Code	Cap.	Tol.	Part Number								
50Vdc	CH	7.6pF	±0.1pF	GRM0222C1H7R6BA03#	50Vdc	CH	8.9pF	±0.5pF	GRM0222C1H8R9DA03#								
			±0.25pF	GRM0222C1H7R6CA03#				9.0pF	±0.05pF	GRM0222C1H9R0WA03#							
			±0.5pF	GRM0222C1H7R6DA03#					±0.1pF	GRM0222C1H9R0BA03#							
		±0.05pF	GRM0222C1H7R7WA03#	±0.25pF			GRM0222C1H9R0CA03#										
		±0.1pF	GRM0222C1H7R7BA03#	±0.5pF			GRM0222C1H9R0DA03#	9.1pF	±0.05pF	GRM0222C1H9R1WA03#							
		±0.25pF	GRM0222C1H7R7CA03#	±0.1pF			GRM0222C1H9R1BA03#		±0.25pF	GRM0222C1H9R1CA03#							
		±0.5pF	GRM0222C1H7R7DA03#	±0.5pF			GRM0222C1H9R1DA03#		9.2pF	±0.05pF	GRM0222C1H9R2WA03#						
		±0.05pF	GRM0222C1H7R8WA03#	±0.1pF			GRM0222C1H9R2BA03#	±0.25pF		GRM0222C1H9R2CA03#							
		±0.1pF	GRM0222C1H7R8BA03#	±0.5pF			GRM0222C1H9R2DA03#	9.3pF		±0.05pF	GRM0222C1H9R3WA03#						
		±0.25pF	GRM0222C1H7R8CA03#	±0.1pF			GRM0222C1H9R3BA03#		±0.25pF	GRM0222C1H9R3CA03#							
		±0.5pF	GRM0222C1H7R8DA03#	±0.5pF			GRM0222C1H9R3DA03#		9.4pF	±0.05pF	GRM0222C1H9R4WA03#						
		±0.05pF	GRM0222C1H7R9WA03#	±0.1pF			GRM0222C1H9R4BA03#	±0.25pF		GRM0222C1H9R4CA03#							
		±0.1pF	GRM0222C1H7R9BA03#	±0.25pF			GRM0222C1H9R4DA03#	9.5pF		±0.05pF	GRM0222C1H9R5WA03#						
		±0.25pF	GRM0222C1H7R9CA03#	±0.1pF			GRM0222C1H9R5BA03#		±0.25pF	GRM0222C1H9R5CA03#							
		±0.5pF	GRM0222C1H7R9DA03#	±0.5pF			GRM0222C1H9R5DA03#		9.6pF	±0.05pF	GRM0222C1H9R6WA03#						
		±0.05pF	GRM0222C1H8R0WA03#	±0.1pF			GRM0222C1H8R0BA03#	±0.25pF		GRM0222C1H9R6CA03#							
		±0.1pF	GRM0222C1H8R0BA03#	±0.5pF			GRM0222C1H8R0DA03#	±0.5pF		GRM0222C1H9R6DA03#							
		50Vdc	CH	8.0pF			±0.05pF	GRM0222C1H8R0WA03#	50Vdc	CH	9.7pF	±0.05pF	GRM0222C1H9R7WA03#				
							±0.1pF	GRM0222C1H8R0BA03#				±0.1pF	GRM0222C1H9R7BA03#				
							±0.25pF	GRM0222C1H8R0CA03#				±0.25pF	GRM0222C1H9R7CA03#				
				±0.5pF			GRM0222C1H8R0DA03#	9.8pF			±0.5pF	GRM0222C1H9R7DA03#	±0.05pF	GRM0222C1H9R8WA03#			
				±0.05pF			GRM0222C1H8R1WA03#				±0.1pF	GRM0222C1H9R8BA03#	±0.25pF	GRM0222C1H9R8CA03#			
				±0.1pF			GRM0222C1H8R1BA03#				±0.5pF	GRM0222C1H9R8DA03#	9.9pF	±0.05pF	GRM0222C1H9R9WA03#		
				±0.25pF			GRM0222C1H8R1CA03#	±0.1pF			GRM0222C1H9R9BA03#	±0.25pF		GRM0222C1H9R9CA03#			
				±0.5pF			GRM0222C1H8R1DA03#	±0.5pF			GRM0222C1H9R9DA03#	10pF		±2%	GRM0222C1H100GA03#		
				±0.05pF			GRM0222C1H8R2WA03#	±5%			GRM0222C1H100JA03#		11pF	±2%	GRM0222C1H110GA03#		
				±0.1pF			GRM0222C1H8R2BA03#	12pF			±2%			GRM0222C1H120GA03#	±5%	GRM0222C1H110JA03#	
				±0.25pF			GRM0222C1H8R2CA03#				±5%	GRM0222C1H120JA03#		13pF	±2%	GRM0222C1H130GA03#	
				±0.5pF			GRM0222C1H8R2DA03#				±5%	GRM0222C1H130JA03#	15pF		±2%	GRM0222C1H150GA03#	
				±0.05pF			GRM0222C1H8R3WA03#	±5%			GRM0222C1H150JA03#	16pF			±2%	GRM0222C1H160GA03#	
				±0.1pF			GRM0222C1H8R3BA03#	18pF			±2%			GRM0222C1H180GA02#	±5%	GRM0222C1H160JA03#	
				±0.25pF			GRM0222C1H8R3CA03#				8.1pF		±0.05pF	GRM0222C1H8R1WA03#	8.2pF	±0.05pF	GRM0222C1H8R2WA03#
				±0.1pF			GRM0222C1H8R1BA03#					±0.1pF	GRM0222C1H8R2BA03#	±0.25pF		GRM0222C1H8R2CA03#	
				±0.25pF			GRM0222C1H8R1CA03#	±0.5pF				GRM0222C1H8R2DA03#	8.3pF	±0.5pF		GRM0222C1H8R2DA03#	
				±0.5pF			GRM0222C1H8R1DA03#	8.4pF			±0.05pF	GRM0222C1H8R4WA03#		8.5pF	±0.05pF	GRM0222C1H8R5WA03#	
				±0.05pF			GRM0222C1H8R4WA03#				±0.1pF	GRM0222C1H8R4BA03#			±0.1pF	GRM0222C1H8R5BA03#	
				±0.1pF			GRM0222C1H8R4BA03#				±0.25pF	GRM0222C1H8R4CA03#	±0.25pF		GRM0222C1H8R5CA03#		
				±0.25pF			GRM0222C1H8R4CA03#	8.5pF			±0.5pF	GRM0222C1H8R4DA03#	8.6pF	±0.5pF	GRM0222C1H8R5DA03#		
				±0.5pF			GRM0222C1H8R4DA03#				8.7pF	±0.05pF		GRM0222C1H8R7WA03#	8.8pF	±0.05pF	GRM0222C1H8R8WA03#
				±0.05pF			GRM0222C1H8R5WA03#					±0.1pF		GRM0222C1H8R7BA03#		±0.1pF	GRM0222C1H8R8BA03#
				±0.1pF			GRM0222C1H8R5BA03#	±0.25pF				GRM0222C1H8R7CA03#	±0.25pF	GRM0222C1H8R8CA03#			
				±0.25pF			GRM0222C1H8R5CA03#	8.8pF			±0.5pF	GRM0222C1H8R7DA03#	8.9pF	±0.5pF	GRM0222C1H8R8DA03#		
				±0.5pF			GRM0222C1H8R5DA03#				8.9pF	±0.05pF		GRM0222C1H8R9WA03#	8.9pF	±0.05pF	GRM0222C1H8R9WA03#
				±0.05pF			GRM0222C1H8R6WA03#					±0.1pF		GRM0222C1H8R9BA03#		±0.1pF	GRM0222C1H8R9BA03#
				±0.1pF			GRM0222C1H8R6BA03#	±0.25pF				GRM0222C1H8R9CA03#	±0.25pF	GRM0222C1H8R9CA03#			
				±0.25pF			GRM0222C1H8R6CA03#	8.6pF			±0.5pF	GRM0222C1H8R6DA03#	8.7pF	±0.5pF	GRM0222C1H8R6DA03#		
				±0.5pF			GRM0222C1H8R6DA03#				8.7pF	±0.05pF		GRM0222C1H8R7WA03#	8.8pF	±0.05pF	GRM0222C1H8R8WA03#
				±0.05pF			GRM0222C1H8R7WA03#					±0.1pF		GRM0222C1H8R7BA03#		±0.1pF	GRM0222C1H8R8BA03#
				±0.1pF			GRM0222C1H8R7BA03#	±0.25pF				GRM0222C1H8R7CA03#	±0.25pF	GRM0222C1H8R8CA03#			
				±0.25pF			GRM0222C1H8R7CA03#	8.7pF			±0.5pF	GRM0222C1H8R7DA03#	8.8pF	±0.5pF	GRM0222C1H8R8DA03#		
				±0.5pF			GRM0222C1H8R7DA03#				8.8pF	±0.05pF		GRM0222C1H8R8WA03#	8.9pF	±0.05pF	GRM0222C1H8R9WA03#
				±0.05pF			GRM0222C1H8R8WA03#					±0.1pF		GRM0222C1H8R8BA03#		±0.1pF	GRM0222C1H8R9BA03#
				±0.1pF			GRM0222C1H8R8BA03#	±0.25pF				GRM0222C1H8R8CA03#	±0.25pF	GRM0222C1H8R9CA03#			
				±0.25pF			GRM0222C1H8R8CA03#	8.8pF			±0.5pF	GRM0222C1H8R8DA03#	8.9pF	±0.5pF	GRM0222C1H8R8DA03#		
				±0.5pF			GRM0222C1H8R8DA03#				8.9pF	±0.05pF		GRM0222C1H8R9WA03#	8.9pF	±0.05pF	GRM0222C1H8R9WA03#
				±0.05pF			GRM0222C1H8R9WA03#					±0.1pF		GRM0222C1H8R9BA03#		±0.1pF	GRM0222C1H8R9BA03#
				±0.1pF			GRM0222C1H8R9BA03#	±0.25pF				GRM0222C1H8R9CA03#	±0.25pF	GRM0222C1H8R9CA03#			
				±0.25pF			GRM0222C1H8R9CA03#	8.9pF			±0.5pF	GRM0222C1H8R9DA03#	8.9pF	±0.5pF	GRM0222C1H8R9DA03#		

Part number # indicates the package specification code.



GRM Series Temperature Compensating Type Part Number List

(→ 0.4×0.2mm)

Rated Voltage	TC Code	Cap.	Tol.	Part Number	Rated Voltage	TC Code	Cap.	Tol.	Part Number		
50Vdc	CH	18pF	±5%	GRM0222C1H180JA02#	50Vdc	CJ	2.6pF	±0.25pF	GRM0223C1H2R6CA03#		
			±2%	GRM0222C1H200GA02#				2.7pF	±0.05pF	GRM0223C1H2R7WA03#	
		±5%	GRM0222C1H200JA02#	±0.1pF			GRM0223C1H2R7BA03#				
		22pF	±2%	GRM0222C1H220GA02#			±0.25pF	GRM0223C1H2R7CA03#			
			±5%	GRM0222C1H220JA02#			2.8pF	±0.05pF	GRM0223C1H2R8WA03#		
		24pF	±2%	GRM0222C1H240GA02#				±0.1pF	GRM0223C1H2R8BA03#		
			±5%	GRM0222C1H240JA02#				±0.25pF	GRM0223C1H2R8CA03#		
		27pF	±2%	GRM0222C1H270GA02#			2.9pF	±0.05pF	GRM0223C1H2R9WA03#		
			±5%	GRM0222C1H270JA02#				±0.1pF	GRM0223C1H2R9BA03#		
		30pF	±2%	GRM0222C1H300GA02#				±0.25pF	GRM0223C1H2R9CA03#		
			±5%	GRM0222C1H300JA02#			3.0pF	±0.05pF	GRM0223C1H3R0WA03#		
		33pF	±2%	GRM0222C1H330GA02#				±0.1pF	GRM0223C1H3R0BA03#		
			±5%	GRM0222C1H330JA02#				±0.25pF	GRM0223C1H3R0CA03#		
		36pF	±2%	GRM0222C1H360GA02#			3.1pF	±0.05pF	GRM0223C1H3R1WA03#		
			±5%	GRM0222C1H360JA02#				±0.1pF	GRM0223C1H3R1BA03#		
		39pF	±2%	GRM0222C1H390GA02#				±0.25pF	GRM0223C1H3R1CA03#		
			±5%	GRM0222C1H390JA02#			3.2pF	±0.05pF	GRM0223C1H3R2WA03#		
		43pF	±2%	GRM0222C1H430GA02#				±0.1pF	GRM0223C1H3R2BA03#		
			±5%	GRM0222C1H430JA02#				±0.25pF	GRM0223C1H3R2CA03#		
		47pF	±2%	GRM0222C1H470GA02#			3.3pF	±0.05pF	GRM0223C1H3R3WA03#		
			±5%	GRM0222C1H470JA02#				±0.1pF	GRM0223C1H3R3BA03#		
		51pF	±2%	GRM0222C1H510GA02#				±0.25pF	GRM0223C1H3R3CA03#		
			±5%	GRM0222C1H510JA02#			3.4pF	±0.05pF	GRM0223C1H3R4WA03#		
		56pF	±2%	GRM0222C1H560GA02#				±0.1pF	GRM0223C1H3R4BA03#		
			±5%	GRM0222C1H560JA02#				±0.25pF	GRM0223C1H3R4CA03#		
		62pF	±2%	GRM0222C1H620GA02#			3.5pF	±0.05pF	GRM0223C1H3R5WA03#		
			±5%	GRM0222C1H620JA02#				±0.1pF	GRM0223C1H3R5BA03#		
		68pF	±2%	GRM0222C1H680GA02#				±0.25pF	GRM0223C1H3R5CA03#		
			±5%	GRM0222C1H680JA02#			3.6pF	±0.05pF	GRM0223C1H3R6WA03#		
		75pF	±2%	GRM0222C1H750GA02#				±0.1pF	GRM0223C1H3R6BA03#		
			±5%	GRM0222C1H750JA02#				±0.25pF	GRM0223C1H3R6CA03#		
		82pF	±2%	GRM0222C1H820GA02#			3.7pF	±0.05pF	GRM0223C1H3R7WA03#		
			±5%	GRM0222C1H820JA02#				±0.1pF	GRM0223C1H3R7BA03#		
		91pF	±2%	GRM0222C1H910GA02#				±0.25pF	GRM0223C1H3R7CA03#		
			±5%	GRM0222C1H910JA02#			3.8pF	±0.05pF	GRM0223C1H3R8WA03#		
		100pF	±2%	GRM0222C1H101GA02#				±0.1pF	GRM0223C1H3R8BA03#		
	±5%		GRM0222C1H101JA02#	±0.25pF		GRM0223C1H3R8CA03#					
	CJ	2.1pF	±0.05pF	GRM0223C1H2R1WA03#		3.9pF	±0.05pF	GRM0223C1H3R9WA03#			
			±0.1pF	GRM0223C1H2R1BA03#			±0.1pF	GRM0223C1H3R9BA03#			
			±0.25pF	GRM0223C1H2R1CA03#			±0.25pF	GRM0223C1H3R9CA03#			
			2.2pF	±0.05pF			GRM0223C1H2R2WA03#	CK	0.20pF	±0.05pF	GRM0224C1HR20WA03#
				±0.1pF			GRM0223C1H2R2BA03#			±0.1pF	GRM0224C1HR20BA03#
				±0.25pF			GRM0223C1H2R2CA03#		0.30pF	±0.05pF	GRM0224C1HR30WA03#
		2.3pF	±0.05pF	GRM0223C1H2R3WA03#		±0.1pF	GRM0224C1HR30BA03#				
			±0.1pF	GRM0223C1H2R3BA03#		0.40pF	±0.05pF		GRM0224C1HR40WA03#		
			±0.25pF	GRM0223C1H2R3CA03#			±0.1pF		GRM0224C1HR40BA03#		
		2.4pF	±0.05pF	GRM0223C1H2R4WA03#		0.50pF	±0.05pF	GRM0224C1HR50WA03#			
			±0.1pF	GRM0223C1H2R4BA03#			±0.1pF	GRM0224C1HR50BA03#			
±0.25pF			GRM0223C1H2R4CA03#	0.60pF	±0.05pF	GRM0224C1HR60WA03#					
2.5pF		±0.05pF	GRM0223C1H2R5WA03#		±0.1pF	GRM0224C1HR60BA03#					
		±0.1pF	GRM0223C1H2R5BA03#	0.70pF	±0.05pF	GRM0224C1HR70WA03#					
		±0.25pF	GRM0223C1H2R5CA03#		±0.1pF	GRM0224C1HR70BA03#					
2.6pF		±0.05pF	GRM0223C1H2R6WA03#	0.80pF	±0.05pF	GRM0224C1HR80WA03#					
		±0.1pF	GRM0223C1H2R6BA03#		±0.1pF	GRM0224C1HR80BA03#					

- GRM
- GR3
- GRJ
- GR4
- GJM
- GQM
- GA2
- GA3 GB
- GA3 GD
- GA3 GF
- LLL
- LLA
- LLM
- LLR
- NFM
- GJ4
- ZRA
- ZRB
- KRM
- KR3
- GMA
- GMD
- ⚠Caution /Notice

Part number # indicates the package specification code.

GRM Series Temperature Compensating Type Part Number List

(→ 0.4×0.2mm)

Rated Voltage	TC Code	Cap.	Tol.	Part Number	Rated Voltage	TC Code	Cap.	Tol.	Part Number						
50Vdc	CK	0.90pF	±0.05pF	GRM0224C1HR90WA03#	25Vdc	COG	1.0pF	±0.1pF	GRM0225C1E1R0BA03#						
			±0.1pF	GRM0224C1HR90BA03#				±0.25pF	GRM0225C1E1R0CA03#						
		1.0pF	±0.05pF	GRM0224C1H1R0WA03#			1.1pF	±0.05pF	GRM0225C1E1R1WA03#						
			±0.1pF	GRM0224C1H1R0BA03#				±0.1pF	GRM0225C1E1R1BA03#						
			±0.25pF	GRM0224C1H1R0CA03#				±0.25pF	GRM0225C1E1R1CA03#						
		1.1pF	±0.05pF	GRM0224C1H1R1WA03#			1.2pF	±0.05pF	GRM0225C1E1R2WA03#						
			±0.1pF	GRM0224C1H1R1BA03#				±0.1pF	GRM0225C1E1R2BA03#						
			±0.25pF	GRM0224C1H1R1CA03#				±0.25pF	GRM0225C1E1R2CA03#						
		1.2pF	±0.05pF	GRM0224C1H1R2WA03#			1.3pF	±0.05pF	GRM0225C1E1R3WA03#						
			±0.1pF	GRM0224C1H1R2BA03#				±0.1pF	GRM0225C1E1R3BA03#						
			±0.25pF	GRM0224C1H1R2CA03#				±0.25pF	GRM0225C1E1R3CA03#						
		1.3pF	±0.05pF	GRM0224C1H1R3WA03#			1.4pF	±0.05pF	GRM0225C1E1R4WA03#						
			±0.1pF	GRM0224C1H1R3BA03#				±0.1pF	GRM0225C1E1R4BA03#						
			±0.25pF	GRM0224C1H1R3CA03#				±0.25pF	GRM0225C1E1R4CA03#						
		1.4pF	±0.05pF	GRM0224C1H1R4WA03#			1.5pF	±0.05pF	GRM0225C1E1R5WA03#						
			±0.1pF	GRM0224C1H1R4BA03#				±0.1pF	GRM0225C1E1R5BA03#						
			±0.25pF	GRM0224C1H1R4CA03#				±0.25pF	GRM0225C1E1R5CA03#						
		1.5pF	±0.05pF	GRM0224C1H1R5WA03#			1.6pF	±0.05pF	GRM0225C1E1R6WA03#						
			±0.1pF	GRM0224C1H1R5BA03#				±0.1pF	GRM0225C1E1R6BA03#						
			±0.25pF	GRM0224C1H1R5CA03#				±0.25pF	GRM0225C1E1R6CA03#						
		1.6pF	±0.05pF	GRM0224C1H1R6WA03#			1.7pF	±0.05pF	GRM0225C1E1R7WA03#						
			±0.1pF	GRM0224C1H1R6BA03#				±0.1pF	GRM0225C1E1R7BA03#						
			±0.25pF	GRM0224C1H1R6CA03#				±0.25pF	GRM0225C1E1R7CA03#						
		1.7pF	±0.05pF	GRM0224C1H1R7WA03#			1.8pF	±0.05pF	GRM0225C1E1R8WA03#						
			±0.1pF	GRM0224C1H1R7BA03#				±0.1pF	GRM0225C1E1R8BA03#						
			±0.25pF	GRM0224C1H1R7CA03#				±0.25pF	GRM0225C1E1R8CA03#						
		1.8pF	±0.05pF	GRM0224C1H1R8WA03#			1.9pF	±0.05pF	GRM0225C1E1R9WA03#						
			±0.1pF	GRM0224C1H1R8BA03#				±0.1pF	GRM0225C1E1R9BA03#						
			±0.25pF	GRM0224C1H1R8CA03#				±0.25pF	GRM0225C1E1R9CA03#						
		1.9pF	±0.05pF	GRM0224C1H1R9WA03#			2.0pF	±0.05pF	GRM0225C1E2R0WA03#						
			±0.1pF	GRM0224C1H1R9BA03#				±0.1pF	GRM0225C1E2R0BA03#						
			±0.25pF	GRM0224C1H1R9CA03#				±0.25pF	GRM0225C1E2R0CA03#						
		2.0pF	±0.05pF	GRM0224C1H2R0WA03#			2.1pF	±0.05pF	GRM0225C1E2R1WA03#						
			±0.1pF	GRM0224C1H2R0BA03#				±0.1pF	GRM0225C1E2R1BA03#						
			±0.25pF	GRM0224C1H2R0CA03#				±0.25pF	GRM0225C1E2R1CA03#						
		35Vdc	COG	100pF			±2%	GRM0225CVA101GA02#	2.2pF	COG	±0.05pF	±0.1pF	GRM0225C1E2R2WA03#		
							±5%	GRM0225CVA101JA02#				±0.1pF	GRM0225C1E2R2BA03#		
		25Vdc	COG	0.20pF			±0.05pF	GRM0225C1ER20WA03#	2.3pF	COG	±0.05pF	±0.1pF	GRM0225C1E2R3WA03#		
							±0.1pF	GRM0225C1ER20BA03#				±0.1pF	GRM0225C1E2R3BA03#		
				0.30pF			±0.05pF	GRM0225C1ER30WA03#			±0.25pF	±0.25pF	GRM0225C1E2R3CA03#		
							±0.1pF	GRM0225C1ER30BA03#				2.4pF	±0.05pF	GRM0225C1E2R4WA03#	
				0.40pF			±0.05pF	GRM0225C1ER40WA03#			±0.1pF		GRM0225C1E2R4BA03#		
							±0.1pF	GRM0225C1ER40BA03#			±0.25pF		GRM0225C1E2R4CA03#		
				0.50pF			±0.05pF	GRM0225C1ER50WA03#			2.5pF	±0.05pF	GRM0225C1E2R5WA03#		
							±0.1pF	GRM0225C1ER50BA03#				±0.1pF	GRM0225C1E2R5BA03#		
				0.60pF			±0.05pF	GRM0225C1ER60WA03#			±0.25pF	GRM0225C1E2R5CA03#	2.6pF	±0.05pF	GRM0225C1E2R6WA03#
							±0.1pF	GRM0225C1ER60BA03#			±0.1pF	GRM0225C1E2R6BA03#			
				0.70pF			±0.05pF	GRM0225C1ER70WA03#			±0.25pF	GRM0225C1E2R6CA03#		±0.1pF	GRM0225C1E2R7WA03#
±0.1pF	GRM0225C1ER70BA03#				2.7pF	±0.05pF	GRM0225C1E2R7WA03#								
0.80pF	±0.05pF			GRM0225C1ER80WA03#		±0.1pF	GRM0225C1E2R7BA03#								
	±0.1pF			GRM0225C1ER80BA03#		±0.25pF	GRM0225C1E2R7CA03#								
0.90pF	±0.05pF			GRM0225C1ER90WA03#	2.8pF	±0.05pF	GRM0225C1E2R8WA03#								
	±0.1pF			GRM0225C1ER90BA03#											
1.0pF	±0.05pF			GRM0225C1E1R0WA03#											

Part number # indicates the package specification code.

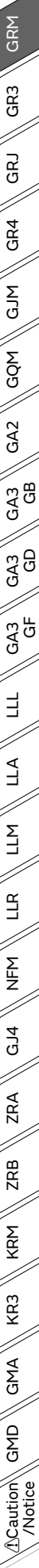

GRM Series Temperature Compensating Type Part Number List

(→ 0.4×0.2mm)

Rated Voltage	TC Code	Cap.	Tol.	Part Number	Rated Voltage	TC Code	Cap.	Tol.	Part Number
25Vdc	COG	2.8pF	±0.1pF	GRM0225C1E2R8BA03#	25Vdc	COG	4.6pF	±0.1pF	GRM0225C1E4R6BA03#
			±0.25pF	GRM0225C1E2R8CA03#				±0.25pF	GRM0225C1E4R6CA03#
		2.9pF	±0.05pF	GRM0225C1E2R9WA03#			4.7pF	±0.05pF	GRM0225C1E4R7WA03#
			±0.1pF	GRM0225C1E2R9BA03#				±0.1pF	GRM0225C1E4R7BA03#
			±0.25pF	GRM0225C1E2R9CA03#				±0.25pF	GRM0225C1E4R7CA03#
		3.0pF	±0.05pF	GRM0225C1E3R0WA03#			4.8pF	±0.05pF	GRM0225C1E4R8WA03#
			±0.1pF	GRM0225C1E3R0BA03#				±0.1pF	GRM0225C1E4R8BA03#
			±0.25pF	GRM0225C1E3R0CA03#				±0.25pF	GRM0225C1E4R8CA03#
		3.1pF	±0.05pF	GRM0225C1E3R1WA03#			4.9pF	±0.05pF	GRM0225C1E4R9WA03#
			±0.1pF	GRM0225C1E3R1BA03#				±0.1pF	GRM0225C1E4R9BA03#
			±0.25pF	GRM0225C1E3R1CA03#				±0.25pF	GRM0225C1E4R9CA03#
		3.2pF	±0.05pF	GRM0225C1E3R2WA03#			5.0pF	±0.05pF	GRM0225C1E5R0WA03#
			±0.1pF	GRM0225C1E3R2BA03#				±0.1pF	GRM0225C1E5R0BA03#
			±0.25pF	GRM0225C1E3R2CA03#				±0.25pF	GRM0225C1E5R0CA03#
		3.3pF	±0.05pF	GRM0225C1E3R3WA03#			5.1pF	±0.05pF	GRM0225C1E5R1WA03#
			±0.1pF	GRM0225C1E3R3BA03#				±0.1pF	GRM0225C1E5R1BA03#
			±0.25pF	GRM0225C1E3R3CA03#				±0.25pF	GRM0225C1E5R1CA03#
		3.4pF	±0.05pF	GRM0225C1E3R4WA03#			5.2pF	±0.05pF	GRM0225C1E5R2WA03#
			±0.1pF	GRM0225C1E3R4BA03#				±0.1pF	GRM0225C1E5R2BA03#
			±0.25pF	GRM0225C1E3R4CA03#				±0.25pF	GRM0225C1E5R2CA03#
		3.5pF	±0.05pF	GRM0225C1E3R5WA03#			5.3pF	±0.05pF	GRM0225C1E5R3WA03#
			±0.1pF	GRM0225C1E3R5BA03#				±0.1pF	GRM0225C1E5R3BA03#
			±0.25pF	GRM0225C1E3R5CA03#				±0.25pF	GRM0225C1E5R3CA03#
		3.6pF	±0.05pF	GRM0225C1E3R6WA03#			5.4pF	±0.05pF	GRM0225C1E5R4WA03#
			±0.1pF	GRM0225C1E3R6BA03#				±0.1pF	GRM0225C1E5R4BA03#
			±0.25pF	GRM0225C1E3R6CA03#				±0.25pF	GRM0225C1E5R4CA03#
		3.7pF	±0.05pF	GRM0225C1E3R7WA03#			5.5pF	±0.05pF	GRM0225C1E5R5WA03#
			±0.1pF	GRM0225C1E3R7BA03#				±0.1pF	GRM0225C1E5R5BA03#
			±0.25pF	GRM0225C1E3R7CA03#				±0.25pF	GRM0225C1E5R5CA03#
		3.8pF	±0.05pF	GRM0225C1E3R8WA03#			5.6pF	±0.05pF	GRM0225C1E5R6WA03#
			±0.1pF	GRM0225C1E3R8BA03#				±0.1pF	GRM0225C1E5R6BA03#
			±0.25pF	GRM0225C1E3R8CA03#				±0.25pF	GRM0225C1E5R6CA03#
		3.9pF	±0.05pF	GRM0225C1E3R9WA03#			5.7pF	±0.05pF	GRM0225C1E5R7WA03#
			±0.1pF	GRM0225C1E3R9BA03#				±0.1pF	GRM0225C1E5R7BA03#
			±0.25pF	GRM0225C1E3R9CA03#				±0.25pF	GRM0225C1E5R7CA03#
		4.0pF	±0.05pF	GRM0225C1E4R0WA03#			5.8pF	±0.05pF	GRM0225C1E5R8WA03#
			±0.1pF	GRM0225C1E4R0BA03#				±0.1pF	GRM0225C1E5R8BA03#
			±0.25pF	GRM0225C1E4R0CA03#				±0.25pF	GRM0225C1E5R8CA03#
		4.1pF	±0.05pF	GRM0225C1E4R1WA03#			5.9pF	±0.05pF	GRM0225C1E5R9WA03#
			±0.1pF	GRM0225C1E4R1BA03#				±0.1pF	GRM0225C1E5R9BA03#
			±0.25pF	GRM0225C1E4R1CA03#				±0.25pF	GRM0225C1E5R9CA03#
		4.2pF	±0.05pF	GRM0225C1E4R2WA03#			6.0pF	±0.05pF	GRM0225C1E6R0WA03#
			±0.1pF	GRM0225C1E4R2BA03#				±0.1pF	GRM0225C1E6R0BA03#
			±0.25pF	GRM0225C1E4R2CA03#				±0.25pF	GRM0225C1E6R0CA03#
		4.3pF	±0.05pF	GRM0225C1E4R3WA03#				±0.5pF	GRM0225C1E6R0DA03#
			±0.1pF	GRM0225C1E4R3BA03#					
			±0.25pF	GRM0225C1E4R3CA03#					
		4.4pF	±0.05pF	GRM0225C1E4R4WA03#					
			±0.1pF	GRM0225C1E4R4BA03#					
			±0.25pF	GRM0225C1E4R4CA03#					
		4.5pF	±0.05pF	GRM0225C1E4R5WA03#					
			±0.1pF	GRM0225C1E4R5BA03#					
			±0.25pF	GRM0225C1E4R5CA03#					
		4.6pF	±0.05pF	GRM0225C1E4R6WA03#					

- GRM
- GR3
- GRJ
- GR4
- GJM
- GQM
- GA2
- GA3 GB
- GA3 GD
- GA3 GF
- LLL
- LLA
- LLM
- LLR
- NFM
- GJ4
- ZRA
- ZRB
- KRM
- KR3
- GMA
- GMD
- △Caution / Notice

Part number # indicates the package specification code.

GRM Series Temperature Compensating Type Part Number List

(→ 0.4×0.2mm)

Rated Voltage	TC Code	Cap.	Tol.	Part Number	Rated Voltage	TC Code	Cap.	Tol.	Part Number
25Vdc	COG	6.1pF	±0.05pF	GRM0225C1E6R1WA03#	25Vdc	COG	7.4pF	±0.25pF	GRM0225C1E7R4CA03#
			±0.1pF	GRM0225C1E6R1BA03#				±0.5pF	GRM0225C1E7R4DA03#
			±0.25pF	GRM0225C1E6R1CA03#			7.5pF	±0.05pF	GRM0225C1E7R5WA03#
			±0.5pF	GRM0225C1E6R1DA03#				±0.1pF	GRM0225C1E7R5BA03#
		6.2pF	±0.05pF	GRM0225C1E6R2WA03#				±0.25pF	GRM0225C1E7R5CA03#
			±0.1pF	GRM0225C1E6R2BA03#				±0.5pF	GRM0225C1E7R5DA03#
			±0.25pF	GRM0225C1E6R2CA03#			7.6pF	±0.05pF	GRM0225C1E7R6WA03#
			±0.5pF	GRM0225C1E6R2DA03#				±0.1pF	GRM0225C1E7R6BA03#
		6.3pF	±0.05pF	GRM0225C1E6R3WA03#				±0.25pF	GRM0225C1E7R6CA03#
			±0.1pF	GRM0225C1E6R3BA03#				±0.5pF	GRM0225C1E7R6DA03#
			±0.25pF	GRM0225C1E6R3CA03#			7.7pF	±0.05pF	GRM0225C1E7R7WA03#
			±0.5pF	GRM0225C1E6R3DA03#				±0.1pF	GRM0225C1E7R7BA03#
		6.4pF	±0.05pF	GRM0225C1E6R4WA03#				±0.25pF	GRM0225C1E7R7CA03#
			±0.1pF	GRM0225C1E6R4BA03#				±0.5pF	GRM0225C1E7R7DA03#
			±0.25pF	GRM0225C1E6R4CA03#			7.8pF	±0.05pF	GRM0225C1E7R8WA03#
			±0.5pF	GRM0225C1E6R4DA03#				±0.1pF	GRM0225C1E7R8BA03#
		6.5pF	±0.05pF	GRM0225C1E6R5WA03#				±0.25pF	GRM0225C1E7R8CA03#
			±0.1pF	GRM0225C1E6R5BA03#				±0.5pF	GRM0225C1E7R8DA03#
			±0.25pF	GRM0225C1E6R5CA03#			7.9pF	±0.05pF	GRM0225C1E7R9WA03#
			±0.5pF	GRM0225C1E6R5DA03#				±0.1pF	GRM0225C1E7R9BA03#
		6.6pF	±0.05pF	GRM0225C1E6R6WA03#				±0.25pF	GRM0225C1E7R9CA03#
			±0.1pF	GRM0225C1E6R6BA03#				±0.5pF	GRM0225C1E7R9DA03#
			±0.25pF	GRM0225C1E6R6CA03#			8.0pF	±0.05pF	GRM0225C1E8R0WA03#
			±0.5pF	GRM0225C1E6R6DA03#				±0.1pF	GRM0225C1E8R0BA03#
		6.7pF	±0.05pF	GRM0225C1E6R7WA03#				±0.25pF	GRM0225C1E8R0CA03#
			±0.1pF	GRM0225C1E6R7BA03#				±0.5pF	GRM0225C1E8R0DA03#
			±0.25pF	GRM0225C1E6R7CA03#			8.1pF	±0.05pF	GRM0225C1E8R1WA03#
			±0.5pF	GRM0225C1E6R7DA03#				±0.1pF	GRM0225C1E8R1BA03#
		6.8pF	±0.05pF	GRM0225C1E6R8WA03#				±0.25pF	GRM0225C1E8R1CA03#
			±0.1pF	GRM0225C1E6R8BA03#				±0.5pF	GRM0225C1E8R1DA03#
			±0.25pF	GRM0225C1E6R8CA03#			8.2pF	±0.05pF	GRM0225C1E8R2WA03#
			±0.5pF	GRM0225C1E6R8DA03#				±0.1pF	GRM0225C1E8R2BA03#
		6.9pF	±0.05pF	GRM0225C1E6R9WA03#				±0.25pF	GRM0225C1E8R2CA03#
			±0.1pF	GRM0225C1E6R9BA03#				±0.5pF	GRM0225C1E8R2DA03#
			±0.25pF	GRM0225C1E6R9CA03#			8.3pF	±0.05pF	GRM0225C1E8R3WA03#
			±0.5pF	GRM0225C1E6R9DA03#				±0.1pF	GRM0225C1E8R3BA03#
		7.0pF	±0.05pF	GRM0225C1E7R0WA03#				±0.25pF	GRM0225C1E8R3CA03#
			±0.1pF	GRM0225C1E7R0BA03#				±0.5pF	GRM0225C1E8R3DA03#
			±0.25pF	GRM0225C1E7R0CA03#			8.4pF	±0.05pF	GRM0225C1E8R4WA03#
			±0.5pF	GRM0225C1E7R0DA03#				±0.1pF	GRM0225C1E8R4BA03#
		7.1pF	±0.05pF	GRM0225C1E7R1WA03#				±0.25pF	GRM0225C1E8R4CA03#
			±0.1pF	GRM0225C1E7R1BA03#				±0.5pF	GRM0225C1E8R4DA03#
			±0.25pF	GRM0225C1E7R1CA03#			8.5pF	±0.05pF	GRM0225C1E8R5WA03#
			±0.5pF	GRM0225C1E7R1DA03#				±0.1pF	GRM0225C1E8R5BA03#
		7.2pF	±0.05pF	GRM0225C1E7R2WA03#				±0.25pF	GRM0225C1E8R5CA03#
			±0.1pF	GRM0225C1E7R2BA03#				±0.5pF	GRM0225C1E8R5DA03#
			±0.25pF	GRM0225C1E7R2CA03#			8.6pF	±0.05pF	GRM0225C1E8R6WA03#
			±0.5pF	GRM0225C1E7R2DA03#				±0.1pF	GRM0225C1E8R6BA03#
		7.3pF	±0.05pF	GRM0225C1E7R3WA03#				±0.25pF	GRM0225C1E8R6CA03#
			±0.1pF	GRM0225C1E7R3BA03#				±0.5pF	GRM0225C1E8R6DA03#
			±0.25pF	GRM0225C1E7R3CA03#			8.7pF	±0.05pF	GRM0225C1E8R7WA03#
			±0.5pF	GRM0225C1E7R3DA03#				±0.1pF	GRM0225C1E8R7BA03#
		7.4pF	±0.05pF	GRM0225C1E7R4WA03#				±0.25pF	GRM0225C1E8R7CA03#
			±0.1pF	GRM0225C1E7R4BA03#				±0.5pF	GRM0225C1E8R7DA03#

- GRM
- GR3
- GRJ
- GR4
- GJM
- GQM
- GA2
- GA3 GB
- GA3 GD
- GA3 GF
- LLL
- LLA
- LLM
- LLR
- NFM
- GJ4
- ZRA
- ZRB
- KRM
- KR3
- GMA
- GMD
- ⚠Caution /Notice

Part number # indicates the package specification code.

GRM Series Temperature Compensating Type Part Number List

(→ 0.4×0.2mm)

Rated Voltage	TC Code	Cap.	Tol.	Part Number	Rated Voltage	TC Code	Cap.	Tol.	Part Number
25Vdc	COG	8.8pF	±0.05pF	GRM0225C1E8R8WA03#	25Vdc	COG	13pF	±2%	GRM0225C1E130GA03#
			±0.1pF	GRM0225C1E8R8BA03#				±5%	GRM0225C1E130JA03#
			±0.25pF	GRM0225C1E8R8CA03#			15pF	±2%	GRM0225C1E150GA03#
			±0.5pF	GRM0225C1E8R8DA03#				±5%	GRM0225C1E150JA03#
		8.9pF	±0.05pF	GRM0225C1E8R9WA03#			16pF	±2%	GRM0225C1E160GA03#
			±0.1pF	GRM0225C1E8R9BA03#				±5%	GRM0225C1E160JA03#
			±0.25pF	GRM0225C1E8R9CA03#			18pF	±2%	GRM0225C1E180GA02#
			±0.5pF	GRM0225C1E8R9DA03#				±5%	GRM0225C1E180JA02#
		9.0pF	±0.05pF	GRM0225C1E9R0WA03#			20pF	±2%	GRM0225C1E200GA02#
			±0.1pF	GRM0225C1E9R0BA03#				±5%	GRM0225C1E200JA02#
			±0.25pF	GRM0225C1E9R0CA03#			22pF	±2%	GRM0225C1E220GA02#
			±0.5pF	GRM0225C1E9R0DA03#				±5%	GRM0225C1E220JA02#
		9.1pF	±0.05pF	GRM0225C1E9R1WA03#			24pF	±2%	GRM0225C1E240GA02#
			±0.1pF	GRM0225C1E9R1BA03#				±5%	GRM0225C1E240JA02#
			±0.25pF	GRM0225C1E9R1CA03#			27pF	±2%	GRM0225C1E270GA02#
			±0.5pF	GRM0225C1E9R1DA03#				±5%	GRM0225C1E270JA02#
		9.2pF	±0.05pF	GRM0225C1E9R2WA03#			30pF	±2%	GRM0225C1E300GA02#
			±0.1pF	GRM0225C1E9R2BA03#				±5%	GRM0225C1E300JA02#
			±0.25pF	GRM0225C1E9R2CA03#			33pF	±2%	GRM0225C1E330GA02#
			±0.5pF	GRM0225C1E9R2DA03#				±5%	GRM0225C1E330JA02#
		9.3pF	±0.05pF	GRM0225C1E9R3WA03#			36pF	±2%	GRM0225C1E360GA02#
			±0.1pF	GRM0225C1E9R3BA03#				±5%	GRM0225C1E360JA02#
			±0.25pF	GRM0225C1E9R3CA03#			39pF	±2%	GRM0225C1E390GA02#
			±0.5pF	GRM0225C1E9R3DA03#				±5%	GRM0225C1E390JA02#
		9.4pF	±0.05pF	GRM0225C1E9R4WA03#			43pF	±2%	GRM0225C1E430GA02#
			±0.1pF	GRM0225C1E9R4BA03#				±5%	GRM0225C1E430JA02#
			±0.25pF	GRM0225C1E9R4CA03#			47pF	±2%	GRM0225C1E470GA02#
			±0.5pF	GRM0225C1E9R4DA03#				±5%	GRM0225C1E470JA02#
		9.5pF	±0.05pF	GRM0225C1E9R5WA03#			51pF	±2%	GRM0225C1E510GA02#
			±0.1pF	GRM0225C1E9R5BA03#				±5%	GRM0225C1E510JA02#
			±0.25pF	GRM0225C1E9R5CA03#			56pF	±2%	GRM0225C1E560GA02#
			±0.5pF	GRM0225C1E9R5DA03#				±5%	GRM0225C1E560JA02#
		9.6pF	±0.05pF	GRM0225C1E9R6WA03#			62pF	±2%	GRM0225C1E620GA02#
			±0.1pF	GRM0225C1E9R6BA03#				±5%	GRM0225C1E620JA02#
			±0.25pF	GRM0225C1E9R6CA03#			68pF	±2%	GRM0225C1E680GA02#
			±0.5pF	GRM0225C1E9R6DA03#				±5%	GRM0225C1E680JA02#
		9.7pF	±0.05pF	GRM0225C1E9R7WA03#			75pF	±2%	GRM0225C1E750GA02#
			±0.1pF	GRM0225C1E9R7BA03#				±5%	GRM0225C1E750JA02#
			±0.25pF	GRM0225C1E9R7CA03#			82pF	±2%	GRM0225C1E820GA02#
			±0.5pF	GRM0225C1E9R7DA03#				±5%	GRM0225C1E820JA02#
		9.8pF	±0.05pF	GRM0225C1E9R8WA03#			91pF	±2%	GRM0225C1E910GA02#
			±0.1pF	GRM0225C1E9R8BA03#				±5%	GRM0225C1E910JA02#
			±0.25pF	GRM0225C1E9R8CA03#			100pF	±2%	GRM0225C1E101GA02#
			±0.5pF	GRM0225C1E9R8DA03#				±5%	GRM0225C1E101JA02#
		9.9pF	±0.05pF	GRM0225C1E9R9WA03#			110pF	±2%	GRM0225C1E111GA02#
			±0.1pF	GRM0225C1E9R9BA03#				±5%	GRM0225C1E111JA02#
			±0.25pF	GRM0225C1E9R9CA03#			120pF	±2%	GRM0225C1E121GA02#
			±0.5pF	GRM0225C1E9R9DA03#				±5%	GRM0225C1E121JA02#
		10pF	±2%	GRM0225C1E100GA03#			150pF	±2%	GRM0225C1E151GA02#
			±5%	GRM0225C1E100JA03#				±5%	GRM0225C1E151JA02#
		11pF	±2%	GRM0225C1E110GA03#			180pF	±2%	GRM0225C1E181GA02#
			±5%	GRM0225C1E110JA03#				±5%	GRM0225C1E181JA02#
12pF	±2%	GRM0225C1E120GA03#	220pF	±2%	GRM0225C1E221GA02#				
	±5%	GRM0225C1E120JA03#		±5%	GRM0225C1E221JA02#				

Part number # indicates the package specification code.

GRM
 GR3
 GRJ
 GR4
 GJM
 GQM
 GA2
 GA3 GB
 GA3 GD
 GA3 GF
 LLL
 LLA
 LLM
 LLR
 NFM
 GJ4
 ZRA
 ZRB
 KRM
 KR3
 GMA
 GMD
 △Caution / Notice

GRM Series Temperature Compensating Type Part Number List

(→ 0.4×0.2mm)

Rated Voltage	TC Code	Cap.	Tol.	Part Number	Rated Voltage	TC Code	Cap.	Tol.	Part Number	
25Vdc	CH	4.0pF	±0.05pF	GRM0222C1E4R0WA03#	25Vdc	CH	5.6pF	±0.1pF	GRM0222C1E5R6BA03#	
			±0.1pF	GRM0222C1E4R0BA03#				±0.25pF	GRM0222C1E5R6CA03#	
			±0.25pF	GRM0222C1E4R0CA03#				±0.5pF	GRM0222C1E5R6DA03#	
		4.1pF	±0.05pF	GRM0222C1E4R1WA03#			5.7pF	±0.05pF	GRM0222C1E5R7WA03#	
			±0.1pF	GRM0222C1E4R1BA03#				±0.1pF	GRM0222C1E5R7BA03#	
			±0.25pF	GRM0222C1E4R1CA03#				±0.25pF	GRM0222C1E5R7CA03#	
		4.2pF	±0.05pF	GRM0222C1E4R2WA03#			5.8pF	±0.5pF	GRM0222C1E5R7DA03#	
			±0.1pF	GRM0222C1E4R2BA03#				6.0pF	±0.05pF	GRM0222C1E5R8WA03#
			±0.25pF	GRM0222C1E4R2CA03#					±0.1pF	GRM0222C1E5R8BA03#
		4.3pF	±0.05pF	GRM0222C1E4R3WA03#			6.1pF		±0.25pF	GRM0222C1E5R8CA03#
			±0.1pF	GRM0222C1E4R3BA03#				±0.5pF	GRM0222C1E5R8DA03#	
			±0.25pF	GRM0222C1E4R3CA03#				5.9pF	±0.05pF	GRM0222C1E5R9WA03#
		4.4pF	±0.05pF	GRM0222C1E4R4WA03#			6.2pF		±0.1pF	GRM0222C1E5R9BA03#
			±0.1pF	GRM0222C1E4R4BA03#					±0.25pF	GRM0222C1E5R9CA03#
			±0.25pF	GRM0222C1E4R4CA03#				±0.5pF	GRM0222C1E5R9DA03#	
		4.5pF	±0.05pF	GRM0222C1E4R5WA03#			6.3pF	±0.05pF	GRM0222C1E6R0WA03#	
			±0.1pF	GRM0222C1E4R5BA03#				±0.1pF	GRM0222C1E6R0BA03#	
			±0.25pF	GRM0222C1E4R5CA03#				±0.25pF	GRM0222C1E6R0CA03#	
		4.6pF	±0.05pF	GRM0222C1E4R6WA03#			6.4pF	±0.5pF	GRM0222C1E6R0DA03#	
			±0.1pF	GRM0222C1E4R6BA03#				6.5pF	±0.05pF	GRM0222C1E6R4WA03#
			±0.25pF	GRM0222C1E4R6CA03#					±0.1pF	GRM0222C1E6R4BA03#
		4.7pF	±0.05pF	GRM0222C1E4R7WA03#			6.6pF		±0.25pF	GRM0222C1E6R4CA03#
			±0.1pF	GRM0222C1E4R7BA03#				±0.5pF	GRM0222C1E6R4DA03#	
			±0.25pF	GRM0222C1E4R7CA03#				6.7pF	±0.05pF	GRM0222C1E6R5WA03#
		4.8pF	±0.05pF	GRM0222C1E4R8WA03#			6.8pF		±0.1pF	GRM0222C1E6R5BA03#
			±0.1pF	GRM0222C1E4R8BA03#					±0.25pF	GRM0222C1E6R5CA03#
			±0.25pF	GRM0222C1E4R8CA03#				±0.5pF	GRM0222C1E6R5DA03#	
		4.9pF	±0.05pF	GRM0222C1E4R9WA03#			6.9pF	±0.05pF	GRM0222C1E6R6WA03#	
			±0.1pF	GRM0222C1E4R9BA03#				±0.1pF	GRM0222C1E6R6BA03#	
			±0.25pF	GRM0222C1E4R9CA03#				±0.25pF	GRM0222C1E6R6CA03#	
		5.0pF	±0.05pF	GRM0222C1E5R0WA03#			6.9pF	±0.5pF	GRM0222C1E6R6DA03#	
			±0.1pF	GRM0222C1E5R0BA03#				6.7pF	±0.05pF	GRM0222C1E6R7WA03#
			±0.25pF	GRM0222C1E5R0CA03#					±0.1pF	GRM0222C1E6R7BA03#
		5.1pF	±0.05pF	GRM0222C1E5R1WA03#			6.8pF		±0.25pF	GRM0222C1E6R7CA03#
			±0.1pF	GRM0222C1E5R1BA03#				±0.5pF	GRM0222C1E6R7DA03#	
			±0.25pF	GRM0222C1E5R1CA03#				6.8pF	±0.05pF	GRM0222C1E6R8WA03#
		5.2pF	±0.5pF	GRM0222C1E5R1DA03#			6.9pF		±0.1pF	GRM0222C1E6R8BA03#
			±0.05pF	GRM0222C1E5R2WA03#					±0.25pF	GRM0222C1E6R8CA03#
			±0.1pF	GRM0222C1E5R2BA03#				±0.5pF	GRM0222C1E6R8DA03#	
		5.3pF	±0.25pF	GRM0222C1E5R2CA03#			6.9pF	±0.05pF	GRM0222C1E6R9WA03#	
			±0.5pF	GRM0222C1E5R2DA03#				±0.1pF	GRM0222C1E6R9BA03#	
			±0.05pF	GRM0222C1E5R3WA03#				±0.25pF	GRM0222C1E6R9CA03#	
		5.4pF	±0.1pF	GRM0222C1E5R3BA03#			6.9pF	±0.5pF	GRM0222C1E6R9DA03#	
			±0.25pF	GRM0222C1E5R3CA03#				6.9pF	±0.05pF	GRM0222C1E6R9WA03#
			±0.5pF	GRM0222C1E5R3DA03#					±0.1pF	GRM0222C1E6R9BA03#
		5.5pF	±0.05pF	GRM0222C1E5R4WA03#			6.9pF		±0.25pF	GRM0222C1E6R9CA03#
			±0.1pF	GRM0222C1E5R4BA03#				6.9pF	±0.5pF	GRM0222C1E6R9DA03#
			±0.25pF	GRM0222C1E5R4CA03#					6.9pF	±0.05pF
		5.6pF	±0.5pF	GRM0222C1E5R4DA03#			6.9pF			±0.1pF
			±0.05pF	GRM0222C1E5R5WA03#				6.9pF		±0.25pF
			±0.1pF	GRM0222C1E5R5BA03#					6.9pF	±0.5pF
		5.6pF	±0.25pF	GRM0222C1E5R5CA03#			6.9pF			±0.05pF
			±0.5pF	GRM0222C1E5R5DA03#				6.9pF		±0.1pF
			±0.05pF	GRM0222C1E5R6WA03#					6.9pF	±0.25pF
5.6pF	±0.1pF	GRM0222C1E5R6BA03#	6.9pF	±0.5pF	GRM0222C1E6R9DA03#					

GRM
 GR3
 GRJ
 GR4
 GJM
 GQM
 GA2
 GA3 GB
 GA3 GD
 GA3 GF
 LLL
 LLA
 LLM
 LLR
 NFM
 GJ4
 ZRA
 ZRB
 KRM
 KR3
 GMA
 GMD
 △Caution /Notice

Part number # indicates the package specification code.

GRM Series Temperature Compensating Type Part Number List

(→ 0.4×0.2mm)

Rated Voltage	TC Code	Cap.	Tol.	Part Number	Rated Voltage	TC Code	Cap.	Tol.	Part Number
25Vdc	CH	6.9pF	±0.5pF	GRM0222C1E6R9DA03#	25Vdc	CH	8.3pF	±0.1pF	GRM0222C1E8R3BA03#
			±0.05pF	GRM0222C1E7R0WA03#				±0.25pF	GRM0222C1E8R3CA03#
			±0.1pF	GRM0222C1E7R0BA03#				±0.5pF	GRM0222C1E8R3DA03#
			±0.25pF	GRM0222C1E7R0CA03#				8.4pF	±0.05pF
		±0.5pF	GRM0222C1E7R0DA03#	±0.1pF			GRM0222C1E8R4BA03#		
		7.1pF	±0.05pF	GRM0222C1E7R1WA03#			±0.25pF		GRM0222C1E8R4CA03#
			±0.1pF	GRM0222C1E7R1BA03#			±0.5pF		GRM0222C1E8R4DA03#
			±0.25pF	GRM0222C1E7R1CA03#			8.5pF	±0.05pF	GRM0222C1E8R5WA03#
			±0.5pF	GRM0222C1E7R1DA03#				±0.1pF	GRM0222C1E8R5BA03#
		7.2pF	±0.05pF	GRM0222C1E7R2WA03#				±0.25pF	GRM0222C1E8R5CA03#
			±0.1pF	GRM0222C1E7R2BA03#				±0.5pF	GRM0222C1E8R5DA03#
			±0.25pF	GRM0222C1E7R2CA03#			8.6pF	±0.05pF	GRM0222C1E8R6WA03#
			±0.5pF	GRM0222C1E7R2DA03#				±0.1pF	GRM0222C1E8R6BA03#
		7.3pF	±0.05pF	GRM0222C1E7R3WA03#				±0.25pF	GRM0222C1E8R6CA03#
			±0.1pF	GRM0222C1E7R3BA03#				±0.5pF	GRM0222C1E8R6DA03#
			±0.25pF	GRM0222C1E7R3CA03#			8.7pF	±0.05pF	GRM0222C1E8R7WA03#
			±0.5pF	GRM0222C1E7R3DA03#				±0.1pF	GRM0222C1E8R7BA03#
		7.4pF	±0.05pF	GRM0222C1E7R4WA03#				±0.25pF	GRM0222C1E8R7CA03#
			±0.1pF	GRM0222C1E7R4BA03#				±0.5pF	GRM0222C1E8R7DA03#
			±0.25pF	GRM0222C1E7R4CA03#			8.8pF	±0.05pF	GRM0222C1E8R8WA03#
			±0.5pF	GRM0222C1E7R4DA03#				±0.1pF	GRM0222C1E8R8BA03#
		7.5pF	±0.05pF	GRM0222C1E7R5WA03#				±0.25pF	GRM0222C1E8R8CA03#
			±0.1pF	GRM0222C1E7R5BA03#				±0.5pF	GRM0222C1E8R8DA03#
			±0.25pF	GRM0222C1E7R5CA03#			8.9pF	±0.05pF	GRM0222C1E8R9WA03#
			±0.5pF	GRM0222C1E7R5DA03#				±0.1pF	GRM0222C1E8R9BA03#
		7.6pF	±0.05pF	GRM0222C1E7R6WA03#				±0.25pF	GRM0222C1E8R9CA03#
			±0.1pF	GRM0222C1E7R6BA03#				±0.5pF	GRM0222C1E8R9DA03#
			±0.25pF	GRM0222C1E7R6CA03#			9.0pF	±0.05pF	GRM0222C1E9R0WA03#
			±0.5pF	GRM0222C1E7R6DA03#				±0.1pF	GRM0222C1E9R0BA03#
		7.7pF	±0.05pF	GRM0222C1E7R7WA03#				±0.25pF	GRM0222C1E9R0CA03#
			±0.1pF	GRM0222C1E7R7BA03#				±0.5pF	GRM0222C1E9R0DA03#
			±0.25pF	GRM0222C1E7R7CA03#			9.1pF	±0.05pF	GRM0222C1E9R1WA03#
			±0.5pF	GRM0222C1E7R7DA03#				±0.1pF	GRM0222C1E9R1BA03#
		7.8pF	±0.05pF	GRM0222C1E7R8WA03#				±0.25pF	GRM0222C1E9R1CA03#
			±0.1pF	GRM0222C1E7R8BA03#				±0.5pF	GRM0222C1E9R1DA03#
			±0.25pF	GRM0222C1E7R8CA03#			9.2pF	±0.05pF	GRM0222C1E9R2WA03#
			±0.5pF	GRM0222C1E7R8DA03#				±0.1pF	GRM0222C1E9R2BA03#
		7.9pF	±0.05pF	GRM0222C1E7R9WA03#				±0.25pF	GRM0222C1E9R2CA03#
			±0.1pF	GRM0222C1E7R9BA03#				±0.5pF	GRM0222C1E9R2DA03#
			±0.25pF	GRM0222C1E7R9CA03#			9.3pF	±0.05pF	GRM0222C1E9R3WA03#
			±0.5pF	GRM0222C1E7R9DA03#				±0.1pF	GRM0222C1E9R3BA03#
		8.0pF	±0.05pF	GRM0222C1E8R0WA03#				±0.25pF	GRM0222C1E9R3CA03#
			±0.1pF	GRM0222C1E8R0BA03#				±0.5pF	GRM0222C1E9R3DA03#
			±0.25pF	GRM0222C1E8R0CA03#			9.4pF	±0.05pF	GRM0222C1E9R4WA03#
			±0.5pF	GRM0222C1E8R0DA03#				±0.1pF	GRM0222C1E9R4BA03#
		8.1pF	±0.05pF	GRM0222C1E8R1WA03#				±0.25pF	GRM0222C1E9R4CA03#
			±0.1pF	GRM0222C1E8R1BA03#				±0.5pF	GRM0222C1E9R4DA03#
			±0.25pF	GRM0222C1E8R1CA03#			9.5pF	±0.05pF	GRM0222C1E9R5WA03#
			±0.5pF	GRM0222C1E8R1DA03#				±0.1pF	GRM0222C1E9R5BA03#
		8.2pF	±0.05pF	GRM0222C1E8R2WA03#				±0.25pF	GRM0222C1E9R5CA03#
			±0.1pF	GRM0222C1E8R2BA03#				±0.5pF	GRM0222C1E9R5DA03#
			±0.25pF	GRM0222C1E8R2CA03#			9.6pF	±0.05pF	GRM0222C1E9R6WA03#
			±0.5pF	GRM0222C1E8R2DA03#				±0.1pF	GRM0222C1E9R6BA03#
		8.3pF	±0.05pF	GRM0222C1E8R3WA03#				±0.25pF	GRM0222C1E9R6CA03#

- GRM
- GR3
- GRJ
- GR4
- GJM
- GQM
- GA2
- GA3 GB
- GA3 GD
- GA3 GF
- LLL
- LLA
- LLM
- LLR
- NFM
- GJ4
- ZRA
- ZRB
- KRM
- KR3
- GMA
- GMD
- ⚠Caution /Notice

Part number # indicates the package specification code.

GRM Series Temperature Compensating Type Part Number List

(→ 0.4×0.2mm)

Rated Voltage	TC Code	Cap.	Tol.	Part Number	Rated Voltage	TC Code	Cap.	Tol.	Part Number	
25Vdc	CH	9.6pF	±0.5pF	GRM0222C1E9R6DA03#	25Vdc	CH	68pF	±5%	GRM0222C1E680JA02#	
			±0.05pF	GRM0222C1E9R7WA03#				75pF	±2%	GRM0222C1E750GA02#
		±0.1pF	GRM0222C1E9R7BA03#	±5%			GRM0222C1E750JA02#			
		±0.25pF	GRM0222C1E9R7CA03#	82pF			±2%	GRM0222C1E820GA02#		
		±0.5pF	GRM0222C1E9R7DA03#				±5%	GRM0222C1E820JA02#		
		9.8pF	±0.05pF	GRM0222C1E9R8WA03#			91pF	±2%	GRM0222C1E910GA02#	
			±0.1pF	GRM0222C1E9R8BA03#				±5%	GRM0222C1E910JA02#	
			±0.25pF	GRM0222C1E9R8CA03#				100pF	±2%	GRM0222C1E101GA02#
			±0.5pF	GRM0222C1E9R8DA03#					±5%	GRM0222C1E101JA02#
		9.9pF	±0.05pF	GRM0222C1E9R9WA03#			110pF	±2%	GRM0222C1E111GA02#	
			±0.1pF	GRM0222C1E9R9BA03#				±5%	GRM0222C1E111JA02#	
			±0.25pF	GRM0222C1E9R9CA03#				120pF	±2%	GRM0222C1E121GA02#
			±0.5pF	GRM0222C1E9R9DA03#					±5%	GRM0222C1E121JA02#
		10pF	±2%	GRM0222C1E100GA03#			150pF	±2%	GRM0222C1E151GA02#	
			±5%	GRM0222C1E100JA03#				±5%	GRM0222C1E151JA02#	
		11pF	±2%	GRM0222C1E110GA03#			180pF	±2%	GRM0222C1E181GA02#	
			±5%	GRM0222C1E110JA03#				±5%	GRM0222C1E181JA02#	
		12pF	±2%	GRM0222C1E120GA03#			220pF	±2%	GRM0222C1E221GA02#	
			±5%	GRM0222C1E120JA03#				±5%	GRM0222C1E221JA02#	
		13pF	±2%	GRM0222C1E130GA03#			2.1pF	±0.05pF	GRM0223C1E2R1WA03#	
			±5%	GRM0222C1E130JA03#				±0.1pF	GRM0223C1E2R1BA03#	
		15pF	±2%	GRM0222C1E150GA03#			±0.25pF	GRM0223C1E2R1CA03#		
			±5%	GRM0222C1E150JA03#			2.2pF	±0.05pF	GRM0223C1E2R2WA03#	
		±2%	GRM0222C1E160GA03#	±0.1pF				GRM0223C1E2R2BA03#		
		±5%	GRM0222C1E160JA03#	±0.25pF				GRM0223C1E2R2CA03#		
		18pF	±2%	GRM0222C1E180GA02#			2.3pF	±0.05pF	GRM0223C1E2R3WA03#	
			±5%	GRM0222C1E180JA02#				±0.1pF	GRM0223C1E2R3BA03#	
		±2%	GRM0222C1E200GA02#	±0.25pF				GRM0223C1E2R3CA03#		
		±5%	GRM0222C1E200JA02#	2.4pF			±0.05pF	GRM0223C1E2R4WA03#		
		±2%	GRM0222C1E220GA02#				±0.1pF	GRM0223C1E2R4BA03#		
		±5%	GRM0222C1E220JA02#				±0.25pF	GRM0223C1E2R4CA03#		
		24pF	±2%	GRM0222C1E240GA02#			2.5pF	±0.05pF	GRM0223C1E2R5WA03#	
			±5%	GRM0222C1E240JA02#				±0.1pF	GRM0223C1E2R5BA03#	
		±2%	GRM0222C1E270GA02#	±0.25pF				GRM0223C1E2R5CA03#		
		±5%	GRM0222C1E270JA02#	2.6pF			±0.05pF	GRM0223C1E2R6WA03#		
		±2%	GRM0222C1E300GA02#				±0.1pF	GRM0223C1E2R6BA03#		
		±5%	GRM0222C1E300JA02#				±0.25pF	GRM0223C1E2R6CA03#		
		33pF	±2%	GRM0222C1E330GA02#			2.7pF	±0.05pF	GRM0223C1E2R7WA03#	
			±5%	GRM0222C1E330JA02#				±0.1pF	GRM0223C1E2R7BA03#	
		±2%	GRM0222C1E360GA02#	±0.25pF				GRM0223C1E2R7CA03#		
		±5%	GRM0222C1E360JA02#	2.8pF			±0.05pF	GRM0223C1E2R8WA03#		
		±2%	GRM0222C1E390GA02#				±0.1pF	GRM0223C1E2R8BA03#		
		±5%	GRM0222C1E390JA02#				±0.25pF	GRM0223C1E2R8CA03#		
		43pF	±2%	GRM0222C1E430GA02#			2.9pF	±0.05pF	GRM0223C1E2R9WA03#	
			±5%	GRM0222C1E430JA02#				±0.1pF	GRM0223C1E2R9BA03#	
		±2%	GRM0222C1E470GA02#	±0.25pF				GRM0223C1E2R9CA03#		
		±5%	GRM0222C1E470JA02#	3.0pF			±0.05pF	GRM0223C1E3R0WA03#		
		±2%	GRM0222C1E510GA02#				±0.1pF	GRM0223C1E3R0BA03#		
		±5%	GRM0222C1E510JA02#				±0.25pF	GRM0223C1E3R0CA03#		
		56pF	±2%	GRM0222C1E560GA02#			3.1pF	±0.05pF	GRM0223C1E3R1WA03#	
			±5%	GRM0222C1E560JA02#				±0.1pF	GRM0223C1E3R1BA03#	
		±2%	GRM0222C1E620GA02#	±0.25pF				GRM0223C1E3R1CA03#		
		±5%	GRM0222C1E620JA02#	3.2pF			±0.05pF	GRM0223C1E3R2WA03#		
		±2%	GRM0222C1E680GA02#				±0.1pF	GRM0223C1E3R2BA03#		

Part number # indicates the package specification code.

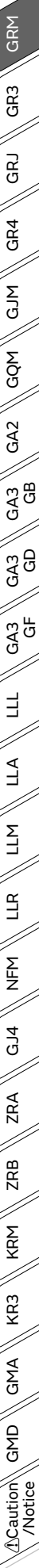

GRM Series Temperature Compensating Type Part Number List

(→ 0.4×0.2mm)

Rated Voltage	TC Code	Cap.	Tol.	Part Number	Rated Voltage	TC Code	Cap.	Tol.	Part Number		
25Vdc	CJ	3.2pF	±0.25pF	GRM0223C1E3R2CA03#	25Vdc	CK	1.5pF	±0.1pF	GRM0224C1E1R5BA03#		
			±0.05pF	GRM0223C1E3R3WA03#				±0.25pF	GRM0224C1E1R5CA03#		
			±0.1pF	GRM0223C1E3R3BA03#				1.6pF	±0.05pF	GRM0224C1E1R6WA03#	
		±0.25pF	GRM0223C1E3R3CA03#	±0.1pF			GRM0224C1E1R6BA03#				
		3.4pF	±0.05pF	GRM0223C1E3R4WA03#			±0.25pF		GRM0224C1E1R6CA03#		
			±0.1pF	GRM0223C1E3R4BA03#			1.7pF	±0.05pF	GRM0224C1E1R7WA03#		
			±0.25pF	GRM0223C1E3R4CA03#				±0.1pF	GRM0224C1E1R7BA03#		
		3.5pF	±0.05pF	GRM0223C1E3R5WA03#				±0.25pF	GRM0224C1E1R7CA03#		
			±0.1pF	GRM0223C1E3R5BA03#			1.8pF	±0.05pF	GRM0224C1E1R8WA03#		
			±0.25pF	GRM0223C1E3R5CA03#				±0.1pF	GRM0224C1E1R8BA03#		
		3.6pF	±0.05pF	GRM0223C1E3R6WA03#				±0.25pF	GRM0224C1E1R8CA03#		
			±0.1pF	GRM0223C1E3R6BA03#			1.9pF	±0.05pF	GRM0224C1E1R9WA03#		
			±0.25pF	GRM0223C1E3R6CA03#				±0.1pF	GRM0224C1E1R9BA03#		
		3.7pF	±0.05pF	GRM0223C1E3R7WA03#				±0.25pF	GRM0224C1E1R9CA03#		
			±0.1pF	GRM0223C1E3R7BA03#			2.0pF	±0.05pF	GRM0224C1E2R0WA03#		
			±0.25pF	GRM0223C1E3R7CA03#				±0.1pF	GRM0224C1E2R0BA03#		
		3.8pF	±0.05pF	GRM0223C1E3R8WA03#				±0.25pF	GRM0224C1E2R0CA03#		
			±0.1pF	GRM0223C1E3R8BA03#			16Vdc	COG	0.20pF	±0.05pF	GRM0225C1CR20WA03#
			±0.25pF	GRM0223C1E3R8CA03#						±0.1pF	GRM0225C1CR20BA03#
		3.9pF	±0.05pF	GRM0223C1E3R9WA03#						0.30pF	±0.05pF
			±0.1pF	GRM0223C1E3R9BA03#			±0.1pF	GRM0225C1CR30BA03#			
			±0.25pF	GRM0223C1E3R9CA03#			0.40pF	±0.05pF	GRM0225C1CR40WA03#		
		0.20pF	±0.05pF	GRM0224C1ER20WA03#				±0.1pF	GRM0225C1CR40BA03#		
			±0.1pF	GRM0224C1ER20BA03#				0.50pF	±0.05pF	GRM0225C1CR50WA03#	
			0.30pF	±0.05pF			GRM0224C1ER30WA03#		±0.1pF	GRM0225C1CR50BA03#	
		±0.1pF		GRM0224C1ER30BA03#			0.60pF		±0.05pF	GRM0225C1CR60WA03#	
		0.40pF		±0.05pF				GRM0224C1ER40WA03#	±0.1pF	GRM0225C1CR60BA03#	
			±0.1pF	GRM0224C1ER40BA03#				0.70pF	±0.05pF	GRM0225C1CR70WA03#	
			0.50pF	±0.05pF			GRM0224C1ER50WA03#		±0.1pF	GRM0225C1CR70BA03#	
		±0.1pF		GRM0224C1ER50BA03#			0.80pF		±0.05pF	GRM0225C1CR80WA03#	
		0.60pF		±0.05pF				GRM0224C1ER60WA03#	±0.1pF	GRM0225C1CR80BA03#	
			±0.1pF	GRM0224C1ER60BA03#				0.90pF	±0.05pF	GRM0225C1CR90WA03#	
			0.70pF	±0.05pF			GRM0224C1ER70WA03#		±0.1pF	GRM0225C1CR90BA03#	
		±0.1pF		GRM0224C1ER70BA03#			1.0pF		±0.05pF	GRM0225C1C1R0WA03#	
		0.80pF		±0.05pF				GRM0224C1ER80WA03#	±0.1pF	GRM0225C1C1R0BA03#	
			±0.1pF	GRM0224C1ER80BA03#				±0.25pF	GRM0225C1C1R0CA03#		
	0.90pF		±0.05pF	GRM0224C1ER90WA03#		1.1pF	±0.05pF	GRM0225C1C1R1WA03#			
		±0.1pF	GRM0224C1ER90BA03#	±0.1pF			GRM0225C1C1R1BA03#				
		±0.25pF	GRM0224C1ER90CA03#	±0.25pF			GRM0225C1C1R1CA03#				
	1.0pF	±0.05pF	GRM0224C1E1R0WA03#	1.2pF		±0.05pF	GRM0225C1C1R2WA03#				
		±0.1pF	GRM0224C1E1R0BA03#			±0.1pF	GRM0225C1C1R2BA03#				
		±0.25pF	GRM0224C1E1R0CA03#			±0.25pF	GRM0225C1C1R2CA03#				
	1.1pF	±0.05pF	GRM0224C1E1R1WA03#	1.3pF		±0.05pF	GRM0225C1C1R3WA03#				
		±0.1pF	GRM0224C1E1R1BA03#			±0.1pF	GRM0225C1C1R3BA03#				
		±0.25pF	GRM0224C1E1R1CA03#			±0.25pF	GRM0225C1C1R3CA03#				
	1.2pF	±0.05pF	GRM0224C1E1R2WA03#	1.4pF		±0.05pF	GRM0225C1C1R4WA03#				
		±0.1pF	GRM0224C1E1R2BA03#			±0.1pF	GRM0225C1C1R4BA03#				
		±0.25pF	GRM0224C1E1R2CA03#			±0.25pF	GRM0225C1C1R4CA03#				
1.3pF	±0.05pF	GRM0224C1E1R3WA03#	1.5pF	±0.05pF	GRM0225C1C1R5WA03#						
	±0.1pF	GRM0224C1E1R3BA03#		±0.1pF	GRM0225C1C1R5BA03#						
	±0.25pF	GRM0224C1E1R3CA03#		±0.25pF	GRM0225C1C1R5CA03#						
1.4pF	±0.05pF	GRM0224C1E1R4WA03#	1.6pF	±0.05pF	GRM0225C1C1R6WA03#						
	±0.1pF	GRM0224C1E1R4BA03#		±0.1pF	GRM0225C1C1R6BA03#						
	±0.25pF	GRM0224C1E1R4CA03#		±0.25pF	GRM0225C1C1R6CA03#						
1.5pF	±0.05pF	GRM0224C1E1R5WA03#									

- GRM
- GR3
- GRJ
- GR4
- GJM
- GQM
- GA2
- GA3 GB
- GA3 GD
- GA3 GF
- LLL
- LLA
- LLM
- LLR
- NFM
- GJ4
- ZRA
- ZRB
- KRM
- KR3
- GMA
- GMD
- △Caution /Notice

Part number # indicates the package specification code.

GRM Series Temperature Compensating Type Part Number List

(→ 0.4×0.2mm)

Rated Voltage	TC Code	Cap.	Tol.	Part Number	Rated Voltage	TC Code	Cap.	Tol.	Part Number
16Vdc	COG	1.7pF	±0.05pF	GRM0225C1C1R7WA03#	16Vdc	COG	3.5pF	±0.05pF	GRM0225C1C3R5WA03#
			±0.1pF	GRM0225C1C1R7BA03#				±0.1pF	GRM0225C1C3R5BA03#
			±0.25pF	GRM0225C1C1R7CA03#				±0.25pF	GRM0225C1C3R5CA03#
		1.8pF	±0.05pF	GRM0225C1C1R8WA03#			3.6pF	±0.05pF	GRM0225C1C3R6WA03#
			±0.1pF	GRM0225C1C1R8BA03#				±0.1pF	GRM0225C1C3R6BA03#
			±0.25pF	GRM0225C1C1R8CA03#				±0.25pF	GRM0225C1C3R6CA03#
		1.9pF	±0.05pF	GRM0225C1C1R9WA03#			3.7pF	±0.05pF	GRM0225C1C3R7WA03#
			±0.1pF	GRM0225C1C1R9BA03#				±0.1pF	GRM0225C1C3R7BA03#
			±0.25pF	GRM0225C1C1R9CA03#				±0.25pF	GRM0225C1C3R7CA03#
		2.0pF	±0.05pF	GRM0225C1C2R0WA03#			3.8pF	±0.05pF	GRM0225C1C3R8WA03#
			±0.1pF	GRM0225C1C2R0BA03#				±0.1pF	GRM0225C1C3R8BA03#
			±0.25pF	GRM0225C1C2R0CA03#				±0.25pF	GRM0225C1C3R8CA03#
		2.1pF	±0.05pF	GRM0225C1C2R1WA03#			3.9pF	±0.05pF	GRM0225C1C3R9WA03#
			±0.1pF	GRM0225C1C2R1BA03#				±0.1pF	GRM0225C1C3R9BA03#
			±0.25pF	GRM0225C1C2R1CA03#				±0.25pF	GRM0225C1C3R9CA03#
		2.2pF	±0.05pF	GRM0225C1C2R2WA03#			4.0pF	±0.05pF	GRM0225C1C4R0WA03#
			±0.1pF	GRM0225C1C2R2BA03#				±0.1pF	GRM0225C1C4R0BA03#
			±0.25pF	GRM0225C1C2R2CA03#				±0.25pF	GRM0225C1C4R0CA03#
		2.3pF	±0.05pF	GRM0225C1C2R3WA03#			4.1pF	±0.05pF	GRM0225C1C4R1WA03#
			±0.1pF	GRM0225C1C2R3BA03#				±0.1pF	GRM0225C1C4R1BA03#
			±0.25pF	GRM0225C1C2R3CA03#				±0.25pF	GRM0225C1C4R1CA03#
		2.4pF	±0.05pF	GRM0225C1C2R4WA03#			4.2pF	±0.05pF	GRM0225C1C4R2WA03#
			±0.1pF	GRM0225C1C2R4BA03#				±0.1pF	GRM0225C1C4R2BA03#
			±0.25pF	GRM0225C1C2R4CA03#				±0.25pF	GRM0225C1C4R2CA03#
		2.5pF	±0.05pF	GRM0225C1C2R5WA03#			4.3pF	±0.05pF	GRM0225C1C4R3WA03#
			±0.1pF	GRM0225C1C2R5BA03#				±0.1pF	GRM0225C1C4R3BA03#
			±0.25pF	GRM0225C1C2R5CA03#				±0.25pF	GRM0225C1C4R3CA03#
		2.6pF	±0.05pF	GRM0225C1C2R6WA03#			4.4pF	±0.05pF	GRM0225C1C4R4WA03#
			±0.1pF	GRM0225C1C2R6BA03#				±0.1pF	GRM0225C1C4R4BA03#
			±0.25pF	GRM0225C1C2R6CA03#				±0.25pF	GRM0225C1C4R4CA03#
		2.7pF	±0.05pF	GRM0225C1C2R7WA03#			4.5pF	±0.05pF	GRM0225C1C4R5WA03#
			±0.1pF	GRM0225C1C2R7BA03#				±0.1pF	GRM0225C1C4R5BA03#
			±0.25pF	GRM0225C1C2R7CA03#				±0.25pF	GRM0225C1C4R5CA03#
		2.8pF	±0.05pF	GRM0225C1C2R8WA03#			4.6pF	±0.05pF	GRM0225C1C4R6WA03#
			±0.1pF	GRM0225C1C2R8BA03#				±0.1pF	GRM0225C1C4R6BA03#
			±0.25pF	GRM0225C1C2R8CA03#				±0.25pF	GRM0225C1C4R6CA03#
		2.9pF	±0.05pF	GRM0225C1C2R9WA03#			4.7pF	±0.05pF	GRM0225C1C4R7WA03#
			±0.1pF	GRM0225C1C2R9BA03#				±0.1pF	GRM0225C1C4R7BA03#
			±0.25pF	GRM0225C1C2R9CA03#				±0.25pF	GRM0225C1C4R7CA03#
		3.0pF	±0.05pF	GRM0225C1C3R0WA03#			4.8pF	±0.05pF	GRM0225C1C4R8WA03#
			±0.1pF	GRM0225C1C3R0BA03#				±0.1pF	GRM0225C1C4R8BA03#
			±0.25pF	GRM0225C1C3R0CA03#				±0.25pF	GRM0225C1C4R8CA03#
		3.1pF	±0.05pF	GRM0225C1C3R1WA03#			4.9pF	±0.05pF	GRM0225C1C4R9WA03#
			±0.1pF	GRM0225C1C3R1BA03#				±0.1pF	GRM0225C1C4R9BA03#
			±0.25pF	GRM0225C1C3R1CA03#				±0.25pF	GRM0225C1C4R9CA03#
		3.2pF	±0.05pF	GRM0225C1C3R2WA03#			5.0pF	±0.05pF	GRM0225C1C5R0WA03#
			±0.1pF	GRM0225C1C3R2BA03#				±0.1pF	GRM0225C1C5R0BA03#
			±0.25pF	GRM0225C1C3R2CA03#				±0.25pF	GRM0225C1C5R0CA03#
3.3pF	±0.05pF	GRM0225C1C3R3WA03#	5.1pF	±0.05pF	GRM0225C1C5R1WA03#				
	±0.1pF	GRM0225C1C3R3BA03#		±0.1pF	GRM0225C1C5R1BA03#				
	±0.25pF	GRM0225C1C3R3CA03#		±0.25pF	GRM0225C1C5R1CA03#				
3.4pF	±0.05pF	GRM0225C1C3R4WA03#	5.2pF	±0.05pF	GRM0225C1C5R2WA03#				
	±0.1pF	GRM0225C1C3R4BA03#		±0.1pF	GRM0225C1C5R2BA03#				
	±0.25pF	GRM0225C1C3R4CA03#							

Part number # indicates the package specification code.

- GRM
- GR3
- GRJ
- GR4
- GJM
- GQM
- GA2
- GA3 GB
- GA3 GD
- GA3 GF
- LLL
- LLA
- LLM
- LLR
- NFM
- GJ4
- ZRA
- ZRB
- KRM
- KR3
- GMA
- GMD
- △Caution /Notice

GRM Series Temperature Compensating Type Part Number List

(→ 0.4×0.2mm)

Rated Voltage	TC Code	Cap.	Tol.	Part Number	Rated Voltage	TC Code	Cap.	Tol.	Part Number
16Vdc	COG	5.2pF	±0.25pF	GRM0225C1C5R2CA03#	16Vdc	COG	6.6pF	±0.05pF	GRM0225C1C6R6WA03#
			±0.5pF	GRM0225C1C5R2DA03#				±0.1pF	GRM0225C1C6R6BA03#
		5.3pF	±0.05pF	GRM0225C1C5R3WA03#			±0.25pF	GRM0225C1C6R6CA03#	
			±0.1pF	GRM0225C1C5R3BA03#			±0.5pF	GRM0225C1C6R6DA03#	
			±0.25pF	GRM0225C1C5R3CA03#			6.7pF	±0.05pF	GRM0225C1C6R7WA03#
			±0.5pF	GRM0225C1C5R3DA03#				±0.1pF	GRM0225C1C6R7BA03#
		5.4pF	±0.05pF	GRM0225C1C5R4WA03#				±0.25pF	GRM0225C1C6R7CA03#
			±0.1pF	GRM0225C1C5R4BA03#			±0.5pF	GRM0225C1C6R7DA03#	
			±0.25pF	GRM0225C1C5R4CA03#			6.8pF	±0.05pF	GRM0225C1C6R8WA03#
		±0.5pF	GRM0225C1C5R4DA03#	±0.1pF				GRM0225C1C6R8BA03#	
		5.5pF	±0.05pF	GRM0225C1C5R5WA03#				±0.25pF	GRM0225C1C6R8CA03#
			±0.1pF	GRM0225C1C5R5BA03#			±0.5pF	GRM0225C1C6R8DA03#	
			±0.25pF	GRM0225C1C5R5CA03#			6.9pF	±0.05pF	GRM0225C1C6R9WA03#
			±0.5pF	GRM0225C1C5R5DA03#				±0.1pF	GRM0225C1C6R9BA03#
		5.6pF	±0.05pF	GRM0225C1C5R6WA03#				±0.25pF	GRM0225C1C6R9CA03#
			±0.1pF	GRM0225C1C5R6BA03#			±0.5pF	GRM0225C1C6R9DA03#	
			±0.25pF	GRM0225C1C5R6CA03#			7.0pF	±0.05pF	GRM0225C1C7R0WA03#
			±0.5pF	GRM0225C1C5R6DA03#				±0.1pF	GRM0225C1C7R0BA03#
		5.7pF	±0.05pF	GRM0225C1C5R7WA03#				±0.25pF	GRM0225C1C7R0CA03#
			±0.1pF	GRM0225C1C5R7BA03#			±0.5pF	GRM0225C1C7R0DA03#	
			±0.25pF	GRM0225C1C5R7CA03#			7.1pF	±0.05pF	GRM0225C1C7R1WA03#
			±0.5pF	GRM0225C1C5R7DA03#				±0.1pF	GRM0225C1C7R1BA03#
		5.8pF	±0.05pF	GRM0225C1C5R8WA03#				±0.25pF	GRM0225C1C7R1CA03#
			±0.1pF	GRM0225C1C5R8BA03#			±0.5pF	GRM0225C1C7R1DA03#	
			±0.25pF	GRM0225C1C5R8CA03#			7.2pF	±0.05pF	GRM0225C1C7R2WA03#
			±0.5pF	GRM0225C1C5R8DA03#				±0.1pF	GRM0225C1C7R2BA03#
		5.9pF	±0.05pF	GRM0225C1C5R9WA03#				±0.25pF	GRM0225C1C7R2CA03#
			±0.1pF	GRM0225C1C5R9BA03#			±0.5pF	GRM0225C1C7R2DA03#	
			±0.25pF	GRM0225C1C5R9CA03#			7.3pF	±0.05pF	GRM0225C1C7R3WA03#
			±0.5pF	GRM0225C1C5R9DA03#				±0.1pF	GRM0225C1C7R3BA03#
		6.0pF	±0.05pF	GRM0225C1C6R0WA03#				±0.25pF	GRM0225C1C7R3CA03#
			±0.1pF	GRM0225C1C6R0BA03#			±0.5pF	GRM0225C1C7R3DA03#	
			±0.25pF	GRM0225C1C6R0CA03#			7.4pF	±0.05pF	GRM0225C1C7R4WA03#
			±0.5pF	GRM0225C1C6R0DA03#				±0.1pF	GRM0225C1C7R4BA03#
		6.1pF	±0.05pF	GRM0225C1C6R1WA03#				±0.25pF	GRM0225C1C7R4CA03#
			±0.1pF	GRM0225C1C6R1BA03#			±0.5pF	GRM0225C1C7R4DA03#	
			±0.25pF	GRM0225C1C6R1CA03#			7.5pF	±0.05pF	GRM0225C1C7R5WA03#
			±0.5pF	GRM0225C1C6R1DA03#				±0.1pF	GRM0225C1C7R5BA03#
		6.2pF	±0.05pF	GRM0225C1C6R2WA03#				±0.25pF	GRM0225C1C7R5CA03#
			±0.1pF	GRM0225C1C6R2BA03#			±0.5pF	GRM0225C1C7R5DA03#	
			±0.25pF	GRM0225C1C6R2CA03#			7.6pF	±0.05pF	GRM0225C1C7R6WA03#
			±0.5pF	GRM0225C1C6R2DA03#				±0.1pF	GRM0225C1C7R6BA03#
		6.3pF	±0.05pF	GRM0225C1C6R3WA03#				±0.25pF	GRM0225C1C7R6CA03#
			±0.1pF	GRM0225C1C6R3BA03#			±0.5pF	GRM0225C1C7R6DA03#	
			±0.25pF	GRM0225C1C6R3CA03#			7.7pF	±0.05pF	GRM0225C1C7R7WA03#
			±0.5pF	GRM0225C1C6R3DA03#				±0.1pF	GRM0225C1C7R7BA03#
		6.4pF	±0.05pF	GRM0225C1C6R4WA03#				±0.25pF	GRM0225C1C7R7CA03#
			±0.1pF	GRM0225C1C6R4BA03#			±0.5pF	GRM0225C1C7R7DA03#	
			±0.25pF	GRM0225C1C6R4CA03#			7.8pF	±0.05pF	GRM0225C1C7R8WA03#
			±0.5pF	GRM0225C1C6R4DA03#				±0.1pF	GRM0225C1C7R8BA03#
		6.5pF	±0.05pF	GRM0225C1C6R5WA03#				±0.25pF	GRM0225C1C7R8CA03#
			±0.1pF	GRM0225C1C6R5BA03#			±0.5pF	GRM0225C1C7R8DA03#	
			±0.25pF	GRM0225C1C6R5CA03#			7.9pF	±0.05pF	GRM0225C1C7R9WA03#
			±0.5pF	GRM0225C1C6R5DA03#				±0.1pF	GRM0225C1C7R9BA03#

Part number # indicates the package specification code.

GRM
 GR3
 GRJ
 GR4
 GJM
 GQM
 GA2
 GA3 GB
 GA3 GD
 GA3 GF
 LLL
 LLA
 LLM
 LLR
 NFM
 GJ4
 ZRA
 ZRB
 KRM
 KR3
 GMA
 GMD
 ⚠Caution / Notice

GRM Series Temperature Compensating Type Part Number List

(→ 0.4×0.2mm)

Rated Voltage	TC Code	Cap.	Tol.	Part Number	Rated Voltage	TC Code	Cap.	Tol.	Part Number
16Vdc	COG	7.9pF	±0.25pF	GRM0225C1C7R9CA03#	16Vdc	COG	9.3pF	±0.05pF	GRM0225C1C9R3WA03#
			±0.5pF	GRM0225C1C7R9DA03#				±0.1pF	GRM0225C1C9R3BA03#
		8.0pF	±0.05pF	GRM0225C1C8R0WA03#			±0.25pF	GRM0225C1C9R3CA03#	
			±0.1pF	GRM0225C1C8R0BA03#			±0.5pF	GRM0225C1C9R3DA03#	
			±0.25pF	GRM0225C1C8R0CA03#			9.4pF	±0.05pF	GRM0225C1C9R4WA03#
			±0.5pF	GRM0225C1C8R0DA03#				±0.1pF	GRM0225C1C9R4BA03#
		8.1pF	±0.05pF	GRM0225C1C8R1WA03#				±0.25pF	GRM0225C1C9R4CA03#
			±0.1pF	GRM0225C1C8R1BA03#			±0.5pF	GRM0225C1C9R4DA03#	
		8.1pF	±0.25pF	GRM0225C1C8R1CA03#			9.5pF	±0.05pF	GRM0225C1C9R5WA03#
			±0.5pF	GRM0225C1C8R1DA03#				±0.1pF	GRM0225C1C9R5BA03#
			8.2pF	±0.05pF				GRM0225C1C8R2WA03#	±0.25pF
				±0.1pF			GRM0225C1C8R2BA03#	±0.5pF	GRM0225C1C9R5DA03#
		8.2pF	±0.25pF	GRM0225C1C8R2CA03#			9.6pF	±0.05pF	GRM0225C1C9R6WA03#
			±0.5pF	GRM0225C1C8R2DA03#				±0.1pF	GRM0225C1C9R6BA03#
			8.3pF	±0.05pF				GRM0225C1C8R3WA03#	±0.25pF
				±0.1pF			GRM0225C1C8R3BA03#	±0.5pF	GRM0225C1C9R6DA03#
		8.3pF	±0.25pF	GRM0225C1C8R3CA03#			9.7pF	±0.05pF	GRM0225C1C9R7WA03#
			±0.5pF	GRM0225C1C8R3DA03#				±0.1pF	GRM0225C1C9R7BA03#
			8.4pF	±0.05pF				GRM0225C1C8R4WA03#	±0.25pF
				±0.1pF			GRM0225C1C8R4BA03#	±0.5pF	GRM0225C1C9R7DA03#
		8.4pF	±0.25pF	GRM0225C1C8R4CA03#			9.8pF	±0.05pF	GRM0225C1C9R8WA03#
			±0.5pF	GRM0225C1C8R4DA03#				±0.1pF	GRM0225C1C9R8BA03#
			8.5pF	±0.05pF				GRM0225C1C8R5WA03#	±0.25pF
				±0.1pF			GRM0225C1C8R5BA03#	±0.5pF	GRM0225C1C9R8DA03#
		8.5pF	±0.25pF	GRM0225C1C8R5CA03#			9.9pF	±0.05pF	GRM0225C1C9R9WA03#
			±0.5pF	GRM0225C1C8R5DA03#				±0.1pF	GRM0225C1C9R9BA03#
			8.6pF	±0.05pF				GRM0225C1C8R6WA03#	±0.25pF
				±0.1pF			GRM0225C1C8R6BA03#	±0.5pF	GRM0225C1C9R9DA03#
		8.6pF	±0.25pF	GRM0225C1C8R6CA03#			10pF	±1%	GRM0225C1C100FA03#
			±0.5pF	GRM0225C1C8R6DA03#				±2%	GRM0225C1C100GA03#
			8.7pF	±0.05pF				GRM0225C1C8R7WA03#	±5%
				±0.1pF			GRM0225C1C8R7BA03#	11pF	±2%
		±0.25pF	GRM0225C1C8R7CA03#	±5%			GRM0225C1C110JA03#		
		8.7pF	±0.5pF	GRM0225C1C8R7DA03#			12pF	±2%	GRM0225C1C120GA03#
			8.8pF	±0.05pF				GRM0225C1C8R8WA03#	±5%
				±0.1pF			GRM0225C1C8R8BA03#	13pF	±2%
			±0.25pF	GRM0225C1C8R8CA03#			±5%		GRM0225C1C130JA03#
		8.8pF	±0.5pF	GRM0225C1C8R8DA03#			15pF	±2%	GRM0225C1C150GA03#
			8.9pF	±0.05pF				GRM0225C1C8R9WA03#	±5%
				±0.1pF			GRM0225C1C8R9BA03#	16pF	±2%
			±0.25pF	GRM0225C1C8R9CA03#			±5%		GRM0225C1C160JA03#
		8.9pF	±0.5pF	GRM0225C1C8R9DA03#			18pF	±2%	GRM0225C1C180GA02#
			9.0pF	±0.05pF				GRM0225C1C9R0WA03#	±5%
				±0.1pF			GRM0225C1C9R0BA03#	20pF	±2%
			±0.25pF	GRM0225C1C9R0CA03#			±5%		GRM0225C1C200JA02#
		9.0pF	±0.5pF	GRM0225C1C9R0DA03#			22pF	±2%	GRM0225C1C220GA02#
			9.1pF	±0.05pF				GRM0225C1C9R1WA03#	±5%
				±0.1pF			GRM0225C1C9R1BA03#	24pF	±2%
			±0.25pF	GRM0225C1C9R1CA03#			±5%		GRM0225C1C240JA02#
		9.1pF	±0.5pF	GRM0225C1C9R1DA03#			27pF	±2%	GRM0225C1C270GA02#
			9.2pF	±0.05pF				GRM0225C1C9R2WA03#	±5%
				±0.1pF			GRM0225C1C9R2BA03#	30pF	±2%
			±0.25pF	GRM0225C1C9R2CA03#			±5%		GRM0225C1C300JA02#
		9.2pF	±0.5pF	GRM0225C1C9R2DA03#			33pF	±2%	GRM0225C1C330GA02#

Part number # indicates the package specification code.



GRM Series Temperature Compensating Type Part Number List

(→ 0.4×0.2mm)

Rated Voltage	TC Code	Cap.	Tol.	Part Number	Rated Voltage	TC Code	Cap.	Tol.	Part Number
16Vdc	COG	33pF	±5%	GRM0225C1C330JA02#	16Vdc	CH	4.6pF	±0.1pF	GRM0222C1C4R6BA03#
			±2%	GRM0225C1C360GA02#				±0.25pF	GRM0222C1C4R6CA03#
		±5%	GRM0225C1C360JA02#	4.7pF			±0.05pF	GRM0222C1C4R7WA03#	
			GRM0225C1C390GA02#				±0.1pF	GRM0222C1C4R7BA03#	
		±5%	GRM0225C1C390JA02#	4.8pF			±0.05pF	GRM0222C1C4R8WA03#	
			GRM0225C1C430GA02#				±0.1pF	GRM0222C1C4R8BA03#	
		±5%	GRM0225C1C430JA02#	4.9pF			±0.25pF	GRM0222C1C4R8CA03#	
			GRM0225C1C470GA02#				±0.05pF	GRM0222C1C4R9WA03#	
		±5%	GRM0225C1C470JA02#	5.0pF			±0.1pF	GRM0222C1C4R9BA03#	
			GRM0225C1C510GA02#				±0.25pF	GRM0222C1C4R9CA03#	
		±5%	GRM0225C1C510JA02#	5.1pF			±0.05pF	GRM0222C1C5R0WA03#	
			GRM0225C1C560GA02#				±0.1pF	GRM0222C1C5R0BA03#	
		±5%	GRM0225C1C560JA02#	62pF			±0.25pF	GRM0222C1C5R0CA03#	
			GRM0225C1C620GA02#				±0.05pF	GRM0222C1C5R1WA03#	
		±5%	GRM0225C1C620JA02#	68pF			±0.1pF	GRM0222C1C5R1BA03#	
			GRM0225C1C680GA02#				±0.25pF	GRM0222C1C5R1CA03#	
		±5%	GRM0225C1C680JA02#	75pF			±0.5pF	GRM0222C1C5R1DA03#	
			GRM0225C1C750GA02#				±0.05pF	GRM0222C1C5R2WA03#	
		±5%	GRM0225C1C750JA02#	82pF			±0.1pF	GRM0222C1C5R2BA03#	
			GRM0225C1C820GA02#				±0.25pF	GRM0222C1C5R2CA03#	
		±5%	GRM0225C1C820JA02#	91pF			±0.5pF	GRM0222C1C5R2DA03#	
			GRM0225C1C910GA02#				±0.05pF	GRM0222C1C5R3WA03#	
		±5%	GRM0225C1C910JA02#	100pF			±0.1pF	GRM0222C1C5R3BA03#	
			GRM0225C1C101GA02#				±0.25pF	GRM0222C1C5R3CA03#	
		±5%	GRM0225C1C101JA02#	110pF			±0.5pF	GRM0222C1C5R3DA03#	
			GRM0225C1C111GA02#				±0.05pF	GRM0222C1C5R4WA03#	
		±5%	GRM0225C1C111JA02#	120pF			±0.1pF	GRM0222C1C5R4BA03#	
			GRM0225C1C121GA02#				±0.25pF	GRM0222C1C5R4CA03#	
		±5%	GRM0225C1C121JA02#	150pF			±0.5pF	GRM0222C1C5R4DA03#	
			GRM0225C1C151GA02#				±0.05pF	GRM0222C1C5R5WA03#	
		±5%	GRM0225C1C151JA02#	180pF			±0.1pF	GRM0222C1C5R5BA03#	
			GRM0225C1C181GA02#				±0.25pF	GRM0222C1C5R5CA03#	
		±5%	GRM0225C1C181JA02#	220pF			±0.5pF	GRM0222C1C5R5DA03#	
			GRM0225C1C221GA02#				±0.05pF	GRM0222C1C5R6WA03#	
		±5%	GRM0225C1C221JA02#	4.0pF			±0.1pF	GRM0222C1C5R6BA03#	
			GRM0222C1C4R0WA03#				±0.25pF	GRM0222C1C5R6CA03#	
		±0.05pF	GRM0222C1C4R0BA03#	4.1pF			±0.5pF	GRM0222C1C5R6DA03#	
							GRM0222C1C4R1WA03#	±0.05pF	GRM0222C1C5R7WA03#
		±0.1pF	GRM0222C1C4R1BA03#	4.2pF			±0.1pF	GRM0222C1C5R7BA03#	
							GRM0222C1C4R2WA03#	±0.25pF	GRM0222C1C5R7CA03#
		±0.25pF	GRM0222C1C4R2BA03#	4.3pF			±0.5pF	GRM0222C1C5R7DA03#	
							GRM0222C1C4R2CA03#	±0.05pF	GRM0222C1C5R8WA03#
±0.25pF	GRM0222C1C4R3WA03#	4.4pF	±0.1pF	GRM0222C1C5R8BA03#					
			GRM0222C1C4R3BA03#	±0.25pF	GRM0222C1C5R8CA03#				
±0.25pF	GRM0222C1C4R3CA03#	4.5pF	±0.5pF	GRM0222C1C5R8DA03#					
			GRM0222C1C4R4WA03#	±0.05pF	GRM0222C1C5R9WA03#				
±0.1pF	GRM0222C1C4R4BA03#	4.6pF	±0.1pF	GRM0222C1C5R9BA03#					
			GRM0222C1C4R4CA03#	±0.25pF	GRM0222C1C5R9CA03#				
±0.25pF	GRM0222C1C4R5WA03#	4.6pF	±0.5pF	GRM0222C1C5R9DA03#					
			GRM0222C1C4R5BA03#	±0.05pF	GRM0222C1C6R0WA03#				
±0.25pF	GRM0222C1C4R5CA03#	4.6pF	±0.1pF	GRM0222C1C6R0BA03#					
			GRM0222C1C4R6WA03#	±0.25pF	GRM0222C1C6R0CA03#				
±0.05pF	GRM0222C1C4R6BA03#	4.6pF	±0.5pF	GRM0222C1C6R0DA03#					
			GRM0222C1C4R6CA03#	±0.05pF	GRM0222C1C6R0WA03#				
±0.1pF	GRM0222C1C4R6BA03#	4.6pF	±0.1pF	GRM0222C1C6R0BA03#					
			GRM0222C1C4R6CA03#	±0.25pF	GRM0222C1C6R0CA03#				
±0.25pF	GRM0222C1C4R6CA03#	4.6pF	±0.5pF	GRM0222C1C6R0DA03#					
			GRM0222C1C4R6DA03#	±0.05pF	GRM0222C1C6R0WA03#				
±0.1pF	GRM0222C1C4R6BA03#	4.6pF	±0.1pF	GRM0222C1C6R0BA03#					
			GRM0222C1C4R6CA03#	±0.25pF	GRM0222C1C6R0CA03#				
±0.25pF	GRM0222C1C4R6CA03#	4.6pF	±0.5pF	GRM0222C1C6R0DA03#					
			GRM0222C1C4R6DA03#	±0.05pF	GRM0222C1C6R0WA03#				

Part number # indicates the package specification code.

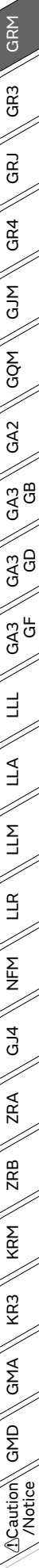

GRM Series Temperature Compensating Type Part Number List

(→ 0.4×0.2mm)

Rated Voltage	TC Code	Cap.	Tol.	Part Number	Rated Voltage	TC Code	Cap.	Tol.	Part Number	
16Vdc	CH	6.1pF	±0.05pF	GRM0222C1C6R1WA03#	16Vdc	CH	7.4pF	±0.25pF	GRM0222C1C7R4CA03#	
			±0.1pF	GRM0222C1C6R1BA03#				±0.5pF	GRM0222C1C7R4DA03#	
			±0.25pF	GRM0222C1C6R1CA03#				7.5pF	±0.05pF	GRM0222C1C7R5WA03#
			±0.5pF	GRM0222C1C6R1DA03#					±0.1pF	GRM0222C1C7R5BA03#
		6.2pF	±0.05pF	GRM0222C1C6R2WA03#			±0.25pF		GRM0222C1C7R5CA03#	
			±0.1pF	GRM0222C1C6R2BA03#			±0.5pF		GRM0222C1C7R5DA03#	
			±0.25pF	GRM0222C1C6R2CA03#			7.6pF	±0.05pF	GRM0222C1C7R6WA03#	
			±0.5pF	GRM0222C1C6R2DA03#				±0.1pF	GRM0222C1C7R6BA03#	
		6.3pF	±0.05pF	GRM0222C1C6R3WA03#				±0.25pF	GRM0222C1C7R6CA03#	
			±0.1pF	GRM0222C1C6R3BA03#				±0.5pF	GRM0222C1C7R6DA03#	
			±0.25pF	GRM0222C1C6R3CA03#			7.7pF	±0.05pF	GRM0222C1C7R7WA03#	
			±0.5pF	GRM0222C1C6R3DA03#				±0.1pF	GRM0222C1C7R7BA03#	
		6.4pF	±0.05pF	GRM0222C1C6R4WA03#				±0.25pF	GRM0222C1C7R7CA03#	
			±0.1pF	GRM0222C1C6R4BA03#				±0.5pF	GRM0222C1C7R7DA03#	
			±0.25pF	GRM0222C1C6R4CA03#			7.8pF	±0.05pF	GRM0222C1C7R8WA03#	
			±0.5pF	GRM0222C1C6R4DA03#				±0.1pF	GRM0222C1C7R8BA03#	
		6.5pF	±0.05pF	GRM0222C1C6R5WA03#				±0.25pF	GRM0222C1C7R8CA03#	
			±0.1pF	GRM0222C1C6R5BA03#				±0.5pF	GRM0222C1C7R8DA03#	
			±0.25pF	GRM0222C1C6R5CA03#			7.9pF	±0.05pF	GRM0222C1C7R9WA03#	
			±0.5pF	GRM0222C1C6R5DA03#				±0.1pF	GRM0222C1C7R9BA03#	
		6.6pF	±0.05pF	GRM0222C1C6R6WA03#				±0.25pF	GRM0222C1C7R9CA03#	
			±0.1pF	GRM0222C1C6R6BA03#				±0.5pF	GRM0222C1C7R9DA03#	
			±0.25pF	GRM0222C1C6R6CA03#			8.0pF	±0.05pF	GRM0222C1C8R0WA03#	
			±0.5pF	GRM0222C1C6R6DA03#				±0.1pF	GRM0222C1C8R0BA03#	
		6.7pF	±0.05pF	GRM0222C1C6R7WA03#				±0.25pF	GRM0222C1C8R0CA03#	
			±0.1pF	GRM0222C1C6R7BA03#				±0.5pF	GRM0222C1C8R0DA03#	
			±0.25pF	GRM0222C1C6R7CA03#			8.1pF	±0.05pF	GRM0222C1C8R1WA03#	
			±0.5pF	GRM0222C1C6R7DA03#				±0.1pF	GRM0222C1C8R1BA03#	
		6.8pF	±0.05pF	GRM0222C1C6R8WA03#				±0.25pF	GRM0222C1C8R1CA03#	
			±0.1pF	GRM0222C1C6R8BA03#				±0.5pF	GRM0222C1C8R1DA03#	
			±0.25pF	GRM0222C1C6R8CA03#			8.2pF	±0.05pF	GRM0222C1C8R2WA03#	
			±0.5pF	GRM0222C1C6R8DA03#				±0.1pF	GRM0222C1C8R2BA03#	
		6.9pF	±0.05pF	GRM0222C1C6R9WA03#				±0.25pF	GRM0222C1C8R2CA03#	
			±0.1pF	GRM0222C1C6R9BA03#				±0.5pF	GRM0222C1C8R2DA03#	
			±0.25pF	GRM0222C1C6R9CA03#			8.3pF	±0.05pF	GRM0222C1C8R3WA03#	
			±0.5pF	GRM0222C1C6R9DA03#				±0.1pF	GRM0222C1C8R3BA03#	
		7.0pF	±0.05pF	GRM0222C1C7R0WA03#				±0.25pF	GRM0222C1C8R3CA03#	
			±0.1pF	GRM0222C1C7R0BA03#				±0.5pF	GRM0222C1C8R3DA03#	
			±0.25pF	GRM0222C1C7R0CA03#			8.4pF	±0.05pF	GRM0222C1C8R4WA03#	
			±0.5pF	GRM0222C1C7R0DA03#				±0.1pF	GRM0222C1C8R4BA03#	
		7.1pF	±0.05pF	GRM0222C1C7R1WA03#				±0.25pF	GRM0222C1C8R4CA03#	
			±0.1pF	GRM0222C1C7R1BA03#				±0.5pF	GRM0222C1C8R4DA03#	
			±0.25pF	GRM0222C1C7R1CA03#			8.5pF	±0.05pF	GRM0222C1C8R5WA03#	
			±0.5pF	GRM0222C1C7R1DA03#				±0.1pF	GRM0222C1C8R5BA03#	
		7.2pF	±0.05pF	GRM0222C1C7R2WA03#				±0.25pF	GRM0222C1C8R5CA03#	
			±0.1pF	GRM0222C1C7R2BA03#				±0.5pF	GRM0222C1C8R5DA03#	
			±0.25pF	GRM0222C1C7R2CA03#			8.6pF	±0.05pF	GRM0222C1C8R6WA03#	
			±0.5pF	GRM0222C1C7R2DA03#				±0.1pF	GRM0222C1C8R6BA03#	
		7.3pF	±0.05pF	GRM0222C1C7R3WA03#				±0.25pF	GRM0222C1C8R6CA03#	
			±0.1pF	GRM0222C1C7R3BA03#				±0.5pF	GRM0222C1C8R6DA03#	
			±0.25pF	GRM0222C1C7R3CA03#			8.7pF	±0.05pF	GRM0222C1C8R7WA03#	
			±0.5pF	GRM0222C1C7R3DA03#				±0.1pF	GRM0222C1C8R7BA03#	
		7.4pF	±0.05pF	GRM0222C1C7R4WA03#				±0.25pF	GRM0222C1C8R7CA03#	
			±0.1pF	GRM0222C1C7R4BA03#				±0.5pF	GRM0222C1C8R7DA03#	

- GRM
- GR3
- GRJ
- GR4
- GJM
- GQM
- GA2
- GA3 GB
- GA3 GD
- GA3 GF
- LLL
- LLA
- LLM
- LLR
- NFM
- GJ4
- ZRA
- ZRB
- KRM
- KR3
- GMA
- GMD
- ⚠Caution /Notice

Part number # indicates the package specification code.

GRM Series Temperature Compensating Type Part Number List

(→ 0.4×0.2mm)

Rated Voltage	TC Code	Cap.	Tol.	Part Number	Rated Voltage	TC Code	Cap.	Tol.	Part Number
16Vdc	CH	8.8pF	±0.05pF	GRM0222C1C8R8WA03#	16Vdc	CH	13pF	±2%	GRM0222C1C130GA03#
			±0.1pF	GRM0222C1C8R8BA03#				±5%	GRM0222C1C130JA03#
			±0.25pF	GRM0222C1C8R8CA03#			15pF	±2%	GRM0222C1C150GA03#
			±0.5pF	GRM0222C1C8R8DA03#				±5%	GRM0222C1C150JA03#
		8.9pF	±0.05pF	GRM0222C1C8R9WA03#			16pF	±2%	GRM0222C1C160GA03#
			±0.1pF	GRM0222C1C8R9BA03#				±5%	GRM0222C1C160JA03#
			±0.25pF	GRM0222C1C8R9CA03#			18pF	±2%	GRM0222C1C180GA02#
			±0.5pF	GRM0222C1C8R9DA03#				±5%	GRM0222C1C180JA02#
		9.0pF	±0.05pF	GRM0222C1C9R0WA03#			20pF	±2%	GRM0222C1C200GA02#
			±0.1pF	GRM0222C1C9R0BA03#				±5%	GRM0222C1C200JA02#
			±0.25pF	GRM0222C1C9R0CA03#			22pF	±2%	GRM0222C1C220GA02#
			±0.5pF	GRM0222C1C9R0DA03#				±5%	GRM0222C1C220JA02#
		9.1pF	±0.05pF	GRM0222C1C9R1WA03#			24pF	±2%	GRM0222C1C240GA02#
			±0.1pF	GRM0222C1C9R1BA03#				±5%	GRM0222C1C240JA02#
			±0.25pF	GRM0222C1C9R1CA03#			27pF	±2%	GRM0222C1C270GA02#
			±0.5pF	GRM0222C1C9R1DA03#				±5%	GRM0222C1C270JA02#
		9.2pF	±0.05pF	GRM0222C1C9R2WA03#			30pF	±2%	GRM0222C1C300GA02#
			±0.1pF	GRM0222C1C9R2BA03#				±5%	GRM0222C1C300JA02#
			±0.25pF	GRM0222C1C9R2CA03#			33pF	±2%	GRM0222C1C330GA02#
			±0.5pF	GRM0222C1C9R2DA03#				±5%	GRM0222C1C330JA02#
		9.3pF	±0.05pF	GRM0222C1C9R3WA03#			36pF	±2%	GRM0222C1C360GA02#
			±0.1pF	GRM0222C1C9R3BA03#				±5%	GRM0222C1C360JA02#
			±0.25pF	GRM0222C1C9R3CA03#			39pF	±2%	GRM0222C1C390GA02#
			±0.5pF	GRM0222C1C9R3DA03#				±5%	GRM0222C1C390JA02#
		9.4pF	±0.05pF	GRM0222C1C9R4WA03#			43pF	±2%	GRM0222C1C430GA02#
			±0.1pF	GRM0222C1C9R4BA03#				±5%	GRM0222C1C430JA02#
			±0.25pF	GRM0222C1C9R4CA03#			47pF	±2%	GRM0222C1C470GA02#
			±0.5pF	GRM0222C1C9R4DA03#				±5%	GRM0222C1C470JA02#
		9.5pF	±0.05pF	GRM0222C1C9R5WA03#			51pF	±2%	GRM0222C1C510GA02#
			±0.1pF	GRM0222C1C9R5BA03#				±5%	GRM0222C1C510JA02#
			±0.25pF	GRM0222C1C9R5CA03#			56pF	±2%	GRM0222C1C560GA02#
			±0.5pF	GRM0222C1C9R5DA03#				±5%	GRM0222C1C560JA02#
		9.6pF	±0.05pF	GRM0222C1C9R6WA03#			62pF	±2%	GRM0222C1C620GA02#
			±0.1pF	GRM0222C1C9R6BA03#				±5%	GRM0222C1C620JA02#
			±0.25pF	GRM0222C1C9R6CA03#			68pF	±2%	GRM0222C1C680GA02#
			±0.5pF	GRM0222C1C9R6DA03#				±5%	GRM0222C1C680JA02#
		9.7pF	±0.05pF	GRM0222C1C9R7WA03#			75pF	±2%	GRM0222C1C750GA02#
			±0.1pF	GRM0222C1C9R7BA03#				±5%	GRM0222C1C750JA02#
			±0.25pF	GRM0222C1C9R7CA03#			82pF	±2%	GRM0222C1C820GA02#
			±0.5pF	GRM0222C1C9R7DA03#				±5%	GRM0222C1C820JA02#
		9.8pF	±0.05pF	GRM0222C1C9R8WA03#			91pF	±2%	GRM0222C1C910GA02#
			±0.1pF	GRM0222C1C9R8BA03#				±5%	GRM0222C1C910JA02#
			±0.25pF	GRM0222C1C9R8CA03#			100pF	±2%	GRM0222C1C101GA02#
			±0.5pF	GRM0222C1C9R8DA03#				±5%	GRM0222C1C101JA02#
		9.9pF	±0.05pF	GRM0222C1C9R9WA03#			110pF	±2%	GRM0222C1C111GA02#
			±0.1pF	GRM0222C1C9R9BA03#				±5%	GRM0222C1C111JA02#
			±0.25pF	GRM0222C1C9R9CA03#			120pF	±2%	GRM0222C1C121GA02#
			±0.5pF	GRM0222C1C9R9DA03#				±5%	GRM0222C1C121JA02#
		10pF	±2%	GRM0222C1C100GA03#			150pF	±2%	GRM0222C1C151GA02#
			±5%	GRM0222C1C100JA03#				±5%	GRM0222C1C151JA02#
		11pF	±2%	GRM0222C1C110GA03#			180pF	±2%	GRM0222C1C181GA02#
			±5%	GRM0222C1C110JA03#				±5%	GRM0222C1C181JA02#
		12pF	±2%	GRM0222C1C120GA03#			220pF	±2%	GRM0222C1C221GA02#
			±5%	GRM0222C1C120JA03#				±5%	GRM0222C1C221JA02#

Part number # indicates the package specification code.

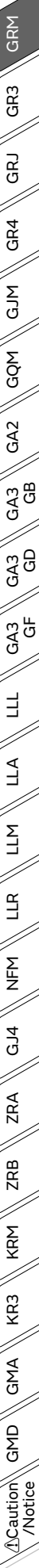

GRM Series Temperature Compensating Type Part Number List

(→ 0.4×0.2mm)

Rated Voltage	TC Code	Cap.	Tol.	Part Number	Rated Voltage	TC Code	Cap.	Tol.	Part Number					
16Vdc	CJ	2.1pF	±0.05pF	GRM0223C1C2R1WA03#	16Vdc	CJ	3.9pF	±0.05pF	GRM0223C1C3R9WA03#					
			±0.1pF	GRM0223C1C2R1BA03#				±0.1pF	GRM0223C1C3R9BA03#					
			±0.25pF	GRM0223C1C2R1CA03#				±0.25pF	GRM0223C1C3R9CA03#					
		2.2pF	±0.05pF	GRM0223C1C2R2WA03#			CK	0.20pF	±0.05pF	GRM0224C1CR20WA03#				
			±0.1pF	GRM0223C1C2R2BA03#					±0.1pF	GRM0224C1CR20BA03#				
			±0.25pF	GRM0223C1C2R2CA03#					0.30pF	±0.05pF	GRM0224C1CR30WA03#			
		2.3pF	±0.05pF	GRM0223C1C2R3WA03#				±0.1pF		GRM0224C1CR30BA03#				
			±0.1pF	GRM0223C1C2R3BA03#				0.40pF	±0.05pF	GRM0224C1CR40WA03#				
		±0.25pF	GRM0223C1C2R3CA03#	±0.1pF					GRM0224C1CR40BA03#					
		2.4pF	±0.05pF	GRM0223C1C2R4WA03#				0.50pF	±0.05pF	GRM0224C1CR50WA03#				
			±0.1pF	GRM0223C1C2R4BA03#					±0.1pF	GRM0224C1CR50BA03#				
			±0.25pF	GRM0223C1C2R4CA03#					0.60pF	±0.05pF	GRM0224C1CR60WA03#			
		2.5pF	±0.05pF	GRM0223C1C2R5WA03#						±0.1pF	GRM0224C1CR60BA03#			
			±0.1pF	GRM0223C1C2R5BA03#					0.70pF	±0.05pF	GRM0224C1CR70WA03#			
		±0.25pF	GRM0223C1C2R5CA03#	±0.1pF						GRM0224C1CR70BA03#				
		2.6pF	±0.05pF	GRM0223C1C2R6WA03#					0.80pF	±0.05pF	GRM0224C1CR80WA03#			
			±0.1pF	GRM0223C1C2R6BA03#						±0.1pF	GRM0224C1CR80BA03#			
			±0.25pF	GRM0223C1C2R6CA03#						0.90pF	±0.05pF	GRM0224C1CR90WA03#		
		2.7pF	±0.05pF	GRM0223C1C2R7WA03#							±0.1pF	GRM0224C1CR90BA03#		
			±0.1pF	GRM0223C1C2R7BA03#						1.0pF	±0.05pF	GRM0224C1C1R0WA03#		
		±0.25pF	GRM0223C1C2R7CA03#	±0.1pF							GRM0224C1C1R0BA03#			
		2.8pF	±0.05pF	GRM0223C1C2R8WA03#							±0.25pF	GRM0224C1C1R0CA03#		
			±0.1pF	GRM0223C1C2R8BA03#						1.1pF	±0.05pF	GRM0224C1C1R1WA03#		
			±0.25pF	GRM0223C1C2R8CA03#							±0.1pF	GRM0224C1C1R1BA03#		
		2.9pF	±0.05pF	GRM0223C1C2R9WA03#							±0.25pF	GRM0224C1C1R1CA03#		
			±0.1pF	GRM0223C1C2R9BA03#						1.2pF	±0.05pF	GRM0224C1C1R2WA03#		
			±0.25pF	GRM0223C1C2R9CA03#							±0.1pF	GRM0224C1C1R2BA03#		
		3.0pF	±0.05pF	GRM0223C1C3R0WA03#							±0.25pF	GRM0224C1C1R2CA03#		
			±0.1pF	GRM0223C1C3R0BA03#						1.3pF	±0.05pF	GRM0224C1C1R3WA03#		
			±0.25pF	GRM0223C1C3R0CA03#							±0.1pF	GRM0224C1C1R3BA03#		
		3.1pF	±0.05pF	GRM0223C1C3R1WA03#							±0.25pF	GRM0224C1C1R3CA03#		
			±0.1pF	GRM0223C1C3R1BA03#						1.4pF	±0.05pF	GRM0224C1C1R4WA03#		
			±0.25pF	GRM0223C1C3R1CA03#							±0.1pF	GRM0224C1C1R4BA03#		
		3.2pF	±0.05pF	GRM0223C1C3R2WA03#							±0.25pF	GRM0224C1C1R4CA03#		
			±0.1pF	GRM0223C1C3R2BA03#						1.5pF	±0.05pF	GRM0224C1C1R5WA03#		
			±0.25pF	GRM0223C1C3R2CA03#							±0.1pF	GRM0224C1C1R5BA03#		
		3.3pF	±0.05pF	GRM0223C1C3R3WA03#							±0.25pF	GRM0224C1C1R5CA03#		
			±0.1pF	GRM0223C1C3R3BA03#						1.6pF	±0.05pF	GRM0224C1C1R6WA03#		
			±0.25pF	GRM0223C1C3R3CA03#							±0.1pF	GRM0224C1C1R6BA03#		
		3.4pF	±0.05pF	GRM0223C1C3R4WA03#							±0.25pF	GRM0224C1C1R6CA03#		
			±0.1pF	GRM0223C1C3R4BA03#						1.7pF	±0.05pF	GRM0224C1C1R7WA03#		
			±0.25pF	GRM0223C1C3R4CA03#							±0.1pF	GRM0224C1C1R7BA03#		
		3.5pF	±0.05pF	GRM0223C1C3R5WA03#							±0.25pF	GRM0224C1C1R7CA03#		
			±0.1pF	GRM0223C1C3R5BA03#						1.8pF	±0.05pF	GRM0224C1C1R8WA03#		
			±0.25pF	GRM0223C1C3R5CA03#							±0.1pF	GRM0224C1C1R8BA03#		
		3.6pF	±0.05pF	GRM0223C1C3R6WA03#							±0.25pF	GRM0224C1C1R8CA03#		
			±0.1pF	GRM0223C1C3R6BA03#						1.9pF	±0.05pF	GRM0224C1C1R9WA03#		
			±0.25pF	GRM0223C1C3R6CA03#							±0.1pF	GRM0224C1C1R9BA03#		
		3.7pF	±0.05pF	GRM0223C1C3R7WA03#							±0.25pF	GRM0224C1C1R9CA03#		
			±0.1pF	GRM0223C1C3R7BA03#						2.0pF	±0.05pF	GRM0224C1C2R0WA03#		
			±0.25pF	GRM0223C1C3R7CA03#							±0.1pF	GRM0224C1C2R0BA03#		
		3.8pF	±0.05pF	GRM0223C1C3R8WA03#							±0.25pF	GRM0224C1C2R0CA03#		
			±0.1pF	GRM0223C1C3R8BA03#						10Vdc	COG	51pF	±2%	GRM0225C1A510GA02#
			±0.25pF	GRM0223C1C3R8CA03#									±5%	GRM0225C1A510JA02#

Part number # indicates the package specification code.

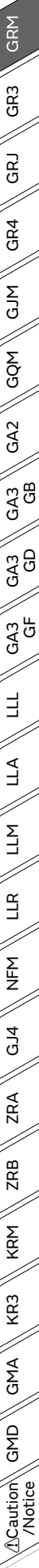

GRM Series Temperature Compensating Type Part Number List

(→ 0.4×0.2mm)

Rated Voltage	TC Code	Cap.	Tol.	Part Number	
10Vdc	COG	56pF	±2%	GRM0225C1A560GA02#	
			±5%	GRM0225C1A560JA02#	
		62pF	±2%	GRM0225C1A620GA02#	
			±5%	GRM0225C1A620JA02#	
		68pF	±2%	GRM0225C1A680GA02#	
			±5%	GRM0225C1A680JA02#	
		75pF	±2%	GRM0225C1A750GA02#	
			±5%	GRM0225C1A750JA02#	
		82pF	±2%	GRM0225C1A820GA02#	
			±5%	GRM0225C1A820JA02#	
		91pF	±2%	GRM0225C1A910GA02#	
			±5%	GRM0225C1A910JA02#	
		100pF	±2%	GRM0225C1A101GA02#	
			±5%	GRM0225C1A101JA02#	
		220pF	±2%	GRM0225C1A221GA02#	
			±5%	GRM0225C1A221JA02#	
		CH	51pF	±2%	GRM0222C1A510GA02#
				±5%	GRM0222C1A510JA02#
			56pF	±2%	GRM0222C1A560GA02#
				±5%	GRM0222C1A560JA02#
			62pF	±2%	GRM0222C1A620GA02#
				±5%	GRM0222C1A620JA02#
			68pF	±2%	GRM0222C1A680GA02#
				±5%	GRM0222C1A680JA02#
	75pF		±2%	GRM0222C1A750GA02#	
			±5%	GRM0222C1A750JA02#	
	82pF		±2%	GRM0222C1A820GA02#	
			±5%	GRM0222C1A820JA02#	
	91pF	±2%	GRM0222C1A910GA02#		
		±5%	GRM0222C1A910JA02#		
	100pF	±2%	GRM0222C1A101GA02#		
		±5%	GRM0222C1A101JA02#		
	220pF	±2%	GRM0222C1A221GA02#		
		±5%	GRM0222C1A221JA02#		
	6.3Vdc	COG	51pF	±2%	GRM0225C0J510GA02#
				±5%	GRM0225C0J510JA02#
56pF			±2%	GRM0225C0J560GA02#	
			±5%	GRM0225C0J560JA02#	
62pF			±2%	GRM0225C0J620GA02#	
			±5%	GRM0225C0J620JA02#	
68pF			±2%	GRM0225C0J680GA02#	
			±5%	GRM0225C0J680JA02#	
75pF			±2%	GRM0225C0J750GA02#	
			±5%	GRM0225C0J750JA02#	
82pF			±2%	GRM0225C0J820GA02#	
			±5%	GRM0225C0J820JA02#	
91pF			±2%	GRM0225C0J910GA02#	
			±5%	GRM0225C0J910JA02#	
100pF			±2%	GRM0225C0J101GA02#	
			±5%	GRM0225C0J101JA02#	
110pF			±2%	GRM0225C0J111GA02#	
			±5%	GRM0225C0J111JA02#	
120pF			±2%	GRM0225C0J121GA02#	
			±5%	GRM0225C0J121JA02#	

Rated Voltage	TC Code	Cap.	Tol.	Part Number	
6.3Vdc	COG	150pF	±2%	GRM0225C0J151GA02#	
			±5%	GRM0225C0J151JA02#	
		180pF	±2%	GRM0225C0J181GA02#	
			±5%	GRM0225C0J181JA02#	
		220pF	±2%	GRM0225C0J221GA02#	
			±5%	GRM0225C0J221JA02#	
		CH	51pF	±2%	GRM0222C0J510GA02#
				±5%	GRM0222C0J510JA02#
			56pF	±2%	GRM0222C0J560GA02#
				±5%	GRM0222C0J560JA02#
			62pF	±2%	GRM0222C0J620GA02#
				±5%	GRM0222C0J620JA02#
			68pF	±2%	GRM0222C0J680GA02#
				±5%	GRM0222C0J680JA02#
			75pF	±2%	GRM0222C0J750GA02#
				±5%	GRM0222C0J750JA02#
			82pF	±2%	GRM0222C0J820GA02#
				±5%	GRM0222C0J820JA02#
			91pF	±2%	GRM0222C0J910GA02#
				±5%	GRM0222C0J910JA02#
			100pF	±2%	GRM0222C0J101GA02#
				±5%	GRM0222C0J101JA02#
			110pF	±2%	GRM0222C0J111GA02#
				±5%	GRM0222C0J111JA02#
	120pF		±2%	GRM0222C0J121GA02#	
			±5%	GRM0222C0J121JA02#	
	150pF		±2%	GRM0222C0J151GA02#	
			±5%	GRM0222C0J151JA02#	
	180pF		±2%	GRM0222C0J181GA02#	
			±5%	GRM0222C0J181JA02#	
	220pF	±2%	GRM0222C0J221GA02#		
		±5%	GRM0222C0J221JA02#		

0.6×0.3mm

Rated Voltage	TC Code	Cap.	Tol.	Part Number
100Vdc	COG	0.10pF	±0.05pF	GRM0335C2AR10WA01#
			±0.1pF	GRM0335C2AR20WA01#
			±0.1pF	GRM0335C2AR20BA01#
		0.20pF	±0.05pF	GRM0335C2AR30WA01#
			±0.1pF	GRM0335C2AR30BA01#
			±0.1pF	GRM0335C2AR40WA01#
		0.30pF	±0.05pF	GRM0335C2AR50WA01#
			±0.1pF	GRM0335C2AR50BA01#
			±0.1pF	GRM0335C2AR60WA01#
		0.40pF	±0.05pF	GRM0335C2AR70WA01#
			±0.1pF	GRM0335C2AR70BA01#
			±0.1pF	GRM0335C2AR80WA01#
		0.50pF	±0.05pF	GRM0335C2AR80BA01#
			±0.1pF	GRM0335C2AR90WA01#
			±0.1pF	GRM0335C2AR90BA01#
		0.60pF	±0.05pF	GRM0335C2AR90WA01#
			±0.1pF	GRM0335C2AR90BA01#
			±0.1pF	GRM0335C2AR90BA01#
		0.70pF	±0.05pF	GRM0335C2AR90WA01#
			±0.1pF	GRM0335C2AR90BA01#
			±0.1pF	GRM0335C2AR90BA01#
		0.80pF	±0.05pF	GRM0335C2AR90WA01#
			±0.1pF	GRM0335C2AR90BA01#
			±0.1pF	GRM0335C2AR90BA01#
0.90pF	±0.05pF	GRM0335C2AR90WA01#		
	±0.1pF	GRM0335C2AR90BA01#		
	±0.1pF	GRM0335C2AR90BA01#		

Part number # indicates the package specification code.

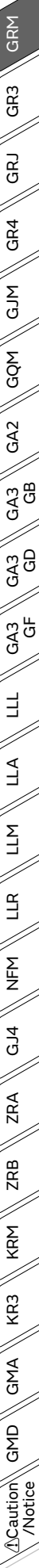

GRM Series Temperature Compensating Type Part Number List

(→ 0.6×0.3mm)

Rated Voltage	TC Code	Cap.	Tol.	Part Number	Rated Voltage	TC Code	Cap.	Tol.	Part Number
100Vdc	COG	1.0pF	±0.05pF	GRM0335C2A1R0WA01#	100Vdc	COG	2.8pF	±0.05pF	GRM0335C2A2R8WA01#
			±0.1pF	GRM0335C2A1R0BA01#				±0.1pF	GRM0335C2A2R8BA01#
			±0.25pF	GRM0335C2A1R0CA01#				±0.25pF	GRM0335C2A2R8CA01#
		1.1pF	±0.05pF	GRM0335C2A1R1WA01#			2.9pF	±0.05pF	GRM0335C2A2R9WA01#
			±0.1pF	GRM0335C2A1R1BA01#				±0.1pF	GRM0335C2A2R9BA01#
			±0.25pF	GRM0335C2A1R1CA01#				±0.25pF	GRM0335C2A2R9CA01#
		1.2pF	±0.05pF	GRM0335C2A1R2WA01#			3.0pF	±0.05pF	GRM0335C2A3R0WA01#
			±0.1pF	GRM0335C2A1R2BA01#				±0.1pF	GRM0335C2A3R0BA01#
			±0.25pF	GRM0335C2A1R2CA01#				±0.25pF	GRM0335C2A3R0CA01#
		1.3pF	±0.05pF	GRM0335C2A1R3WA01#			3.1pF	±0.05pF	GRM0335C2A3R1WA01#
			±0.1pF	GRM0335C2A1R3BA01#				±0.1pF	GRM0335C2A3R1BA01#
			±0.25pF	GRM0335C2A1R3CA01#				±0.25pF	GRM0335C2A3R1CA01#
		1.4pF	±0.05pF	GRM0335C2A1R4WA01#			3.2pF	±0.05pF	GRM0335C2A3R2WA01#
			±0.1pF	GRM0335C2A1R4BA01#				±0.1pF	GRM0335C2A3R2BA01#
			±0.25pF	GRM0335C2A1R4CA01#				±0.25pF	GRM0335C2A3R2CA01#
		1.5pF	±0.05pF	GRM0335C2A1R5WA01#			3.3pF	±0.05pF	GRM0335C2A3R3WA01#
			±0.1pF	GRM0335C2A1R5BA01#				±0.1pF	GRM0335C2A3R3BA01#
			±0.25pF	GRM0335C2A1R5CA01#				±0.25pF	GRM0335C2A3R3CA01#
		1.6pF	±0.05pF	GRM0335C2A1R6WA01#			3.4pF	±0.05pF	GRM0335C2A3R4WA01#
			±0.1pF	GRM0335C2A1R6BA01#				±0.1pF	GRM0335C2A3R4BA01#
			±0.25pF	GRM0335C2A1R6CA01#				±0.25pF	GRM0335C2A3R4CA01#
		1.7pF	±0.05pF	GRM0335C2A1R7WA01#			3.5pF	±0.05pF	GRM0335C2A3R5WA01#
			±0.1pF	GRM0335C2A1R7BA01#				±0.1pF	GRM0335C2A3R5BA01#
			±0.25pF	GRM0335C2A1R7CA01#				±0.25pF	GRM0335C2A3R5CA01#
		1.8pF	±0.05pF	GRM0335C2A1R8WA01#			3.6pF	±0.05pF	GRM0335C2A3R6WA01#
			±0.1pF	GRM0335C2A1R8BA01#				±0.1pF	GRM0335C2A3R6BA01#
			±0.25pF	GRM0335C2A1R8CA01#				±0.25pF	GRM0335C2A3R6CA01#
		1.9pF	±0.05pF	GRM0335C2A1R9WA01#			3.7pF	±0.05pF	GRM0335C2A3R7WA01#
			±0.1pF	GRM0335C2A1R9BA01#				±0.1pF	GRM0335C2A3R7BA01#
			±0.25pF	GRM0335C2A1R9CA01#				±0.25pF	GRM0335C2A3R7CA01#
		2.0pF	±0.05pF	GRM0335C2A2R0WA01#			3.8pF	±0.05pF	GRM0335C2A3R8WA01#
			±0.1pF	GRM0335C2A2R0BA01#				±0.1pF	GRM0335C2A3R8BA01#
			±0.25pF	GRM0335C2A2R0CA01#				±0.25pF	GRM0335C2A3R8CA01#
		2.1pF	±0.05pF	GRM0335C2A2R1WA01#			3.9pF	±0.05pF	GRM0335C2A3R9WA01#
			±0.1pF	GRM0335C2A2R1BA01#				±0.1pF	GRM0335C2A3R9BA01#
			±0.25pF	GRM0335C2A2R1CA01#				±0.25pF	GRM0335C2A3R9CA01#
		2.2pF	±0.05pF	GRM0335C2A2R2WA01#			4.0pF	±0.05pF	GRM0335C2A4R0WA01#
			±0.1pF	GRM0335C2A2R2BA01#				±0.1pF	GRM0335C2A4R0BA01#
			±0.25pF	GRM0335C2A2R2CA01#				±0.25pF	GRM0335C2A4R0CA01#
		2.3pF	±0.05pF	GRM0335C2A2R3WA01#			4.1pF	±0.05pF	GRM0335C2A4R1WA01#
			±0.1pF	GRM0335C2A2R3BA01#				±0.1pF	GRM0335C2A4R1BA01#
			±0.25pF	GRM0335C2A2R3CA01#				±0.25pF	GRM0335C2A4R1CA01#
		2.4pF	±0.05pF	GRM0335C2A2R4WA01#			4.2pF	±0.05pF	GRM0335C2A4R2WA01#
			±0.1pF	GRM0335C2A2R4BA01#				±0.1pF	GRM0335C2A4R2BA01#
			±0.25pF	GRM0335C2A2R4CA01#				±0.25pF	GRM0335C2A4R2CA01#
		2.5pF	±0.05pF	GRM0335C2A2R5WA01#			4.3pF	±0.05pF	GRM0335C2A4R3WA01#
			±0.1pF	GRM0335C2A2R5BA01#				±0.1pF	GRM0335C2A4R3BA01#
			±0.25pF	GRM0335C2A2R5CA01#				±0.25pF	GRM0335C2A4R3CA01#
		2.6pF	±0.05pF	GRM0335C2A2R6WA01#			4.4pF	±0.05pF	GRM0335C2A4R4WA01#
			±0.1pF	GRM0335C2A2R6BA01#				±0.1pF	GRM0335C2A4R4BA01#
			±0.25pF	GRM0335C2A2R6CA01#				±0.25pF	GRM0335C2A4R4CA01#
		2.7pF	±0.05pF	GRM0335C2A2R7WA01#			4.5pF	±0.05pF	GRM0335C2A4R5WA01#
			±0.1pF	GRM0335C2A2R7BA01#				±0.1pF	GRM0335C2A4R5BA01#
			±0.25pF	GRM0335C2A2R7CA01#				±0.25pF	GRM0335C2A4R5CA01#

Part number # indicates the package specification code.

GRM
 GR3
 GRJ
 GR4
 GJM
 GQM
 GA2
 GA3 GB
 GA3 GD
 GA3 GF
 LLL
 LLA
 LLM
 LLR
 NFM
 GJ4
 ZRA
 ZRB
 KRM
 KR3
 GMA
 GMD
 △Caution /Notice

GRM Series Temperature Compensating Type Part Number List

(→ 0.6×0.3mm)

Rated Voltage	TC Code	Cap.	Tol.	Part Number	Rated Voltage	TC Code	Cap.	Tol.	Part Number	
100Vdc	COG	4.6pF	±0.05pF	GRM0335C2A4R6WA01#	100Vdc	COG	6.0pF	±0.5pF	GRM0335C2A6R0DA01#	
			±0.1pF	GRM0335C2A4R6BA01#				6.1pF	±0.05pF	GRM0335C2A6R1WA01#
			±0.25pF	GRM0335C2A4R6CA01#					±0.1pF	GRM0335C2A6R1BA01#
		4.7pF	±0.05pF	GRM0335C2A4R7WA01#			±0.25pF		GRM0335C2A6R1CA01#	
			±0.1pF	GRM0335C2A4R7BA01#			6.2pF	±0.5pF	GRM0335C2A6R1DA01#	
			±0.25pF	GRM0335C2A4R7CA01#				6.3pF	±0.05pF	GRM0335C2A6R2WA01#
		4.8pF	±0.05pF	GRM0335C2A4R8WA01#					±0.1pF	GRM0335C2A6R2BA01#
			±0.1pF	GRM0335C2A4R8BA01#			±0.25pF		GRM0335C2A6R2CA01#	
			±0.25pF	GRM0335C2A4R8CA01#			6.4pF	±0.5pF	GRM0335C2A6R2DA01#	
		4.9pF	±0.05pF	GRM0335C2A4R9WA01#				6.5pF	±0.05pF	GRM0335C2A6R3WA01#
			±0.1pF	GRM0335C2A4R9BA01#					±0.1pF	GRM0335C2A6R3BA01#
			±0.25pF	GRM0335C2A4R9CA01#			±0.25pF		GRM0335C2A6R3CA01#	
		5.0pF	±0.05pF	GRM0335C2A5R0WA01#			6.6pF	±0.5pF	GRM0335C2A6R3DA01#	
			±0.1pF	GRM0335C2A5R0BA01#				6.7pF	±0.05pF	GRM0335C2A6R4WA01#
			±0.25pF	GRM0335C2A5R0CA01#					±0.1pF	GRM0335C2A6R4BA01#
		5.1pF	±0.05pF	GRM0335C2A5R1WA01#			±0.25pF		GRM0335C2A6R4CA01#	
			±0.1pF	GRM0335C2A5R1BA01#			6.8pF	±0.5pF	GRM0335C2A6R4DA01#	
			±0.25pF	GRM0335C2A5R1CA01#				6.9pF	±0.05pF	GRM0335C2A6R5WA01#
		±0.5pF	GRM0335C2A5R1DA01#	±0.1pF					GRM0335C2A6R5BA01#	
		5.2pF	±0.05pF	GRM0335C2A5R2WA01#			±0.25pF		GRM0335C2A6R5CA01#	
			±0.1pF	GRM0335C2A5R2BA01#			7.0pF	±0.5pF	GRM0335C2A6R5DA01#	
			±0.25pF	GRM0335C2A5R2CA01#				7.1pF	±0.05pF	GRM0335C2A6R6WA01#
		±0.5pF	GRM0335C2A5R2DA01#	±0.1pF					GRM0335C2A6R6BA01#	
		5.3pF	±0.05pF	GRM0335C2A5R3WA01#			±0.25pF		GRM0335C2A6R6CA01#	
			±0.1pF	GRM0335C2A5R3BA01#			7.2pF	±0.5pF	GRM0335C2A6R6DA01#	
			±0.25pF	GRM0335C2A5R3CA01#				7.3pF	±0.05pF	GRM0335C2A6R7WA01#
		±0.5pF	GRM0335C2A5R3DA01#	±0.1pF					GRM0335C2A6R7BA01#	
		5.4pF	±0.05pF	GRM0335C2A5R4WA01#			±0.25pF		GRM0335C2A6R7CA01#	
			±0.1pF	GRM0335C2A5R4BA01#			7.4pF	±0.5pF	GRM0335C2A6R7DA01#	
			±0.25pF	GRM0335C2A5R4CA01#				7.5pF	±0.05pF	GRM0335C2A6R8WA01#
		±0.5pF	GRM0335C2A5R4DA01#	±0.1pF					GRM0335C2A6R8BA01#	
		5.5pF	±0.05pF	GRM0335C2A5R5WA01#			±0.25pF		GRM0335C2A6R8CA01#	
			±0.1pF	GRM0335C2A5R5BA01#			7.6pF	±0.5pF	GRM0335C2A6R8DA01#	
			±0.25pF	GRM0335C2A5R5CA01#				7.7pF	±0.05pF	GRM0335C2A6R9WA01#
		±0.5pF	GRM0335C2A5R5DA01#	±0.1pF					GRM0335C2A6R9BA01#	
		5.6pF	±0.05pF	GRM0335C2A5R6WA01#			±0.25pF		GRM0335C2A6R9CA01#	
			±0.1pF	GRM0335C2A5R6BA01#			7.8pF	±0.5pF	GRM0335C2A6R9DA01#	
			±0.25pF	GRM0335C2A5R6CA01#				7.9pF	±0.05pF	GRM0335C2A7R0WA01#
		±0.5pF	GRM0335C2A5R6DA01#	±0.1pF					GRM0335C2A7R0BA01#	
		5.7pF	±0.05pF	GRM0335C2A5R7WA01#			±0.25pF		GRM0335C2A7R0CA01#	
			±0.1pF	GRM0335C2A5R7BA01#			8.0pF	±0.5pF	GRM0335C2A7R0DA01#	
			±0.25pF	GRM0335C2A5R7CA01#				8.1pF	±0.05pF	GRM0335C2A7R1WA01#
		±0.5pF	GRM0335C2A5R7DA01#	±0.1pF					GRM0335C2A7R1BA01#	
		5.8pF	±0.05pF	GRM0335C2A5R8WA01#			±0.25pF		GRM0335C2A7R1CA01#	
			±0.1pF	GRM0335C2A5R8BA01#			8.2pF	±0.5pF	GRM0335C2A7R1DA01#	
			±0.25pF	GRM0335C2A5R8CA01#				8.3pF	±0.05pF	GRM0335C2A7R2WA01#
		±0.5pF	GRM0335C2A5R8DA01#	±0.1pF					GRM0335C2A7R2BA01#	
		5.9pF	±0.05pF	GRM0335C2A5R9WA01#			±0.25pF		GRM0335C2A7R2CA01#	
			±0.1pF	GRM0335C2A5R9BA01#			8.4pF	±0.5pF	GRM0335C2A7R2DA01#	
			±0.25pF	GRM0335C2A5R9CA01#				8.5pF	±0.05pF	GRM0335C2A7R3WA01#
		±0.5pF	GRM0335C2A5R9DA01#	±0.1pF					GRM0335C2A7R3BA01#	
		6.0pF	±0.05pF	GRM0335C2A6R0WA01#			±0.25pF		GRM0335C2A7R3CA01#	
			±0.1pF	GRM0335C2A6R0BA01#			8.6pF	±0.5pF	GRM0335C2A7R3DA01#	
			±0.25pF	GRM0335C2A6R0CA01#				8.7pF	±0.05pF	GRM0335C2A7R4WA01#

Part number # indicates the package specification code.

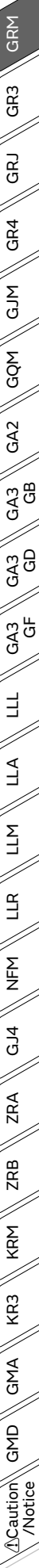

GRM Series Temperature Compensating Type Part Number List

(→ 0.6×0.3mm)

Rated Voltage	TC Code	Cap.	Tol.	Part Number	Rated Voltage	TC Code	Cap.	Tol.	Part Number	
100Vdc	COG	7.4pF	±0.1pF	GRM0335C2A7R4BA01#	100Vdc	COG	8.7pF	±0.5pF	GRM0335C2A8R7DA01#	
			±0.25pF	GRM0335C2A7R4CA01#				8.8pF	±0.05pF	GRM0335C2A8R8WA01#
			±0.5pF	GRM0335C2A7R4DA01#					±0.1pF	GRM0335C2A8R8BA01#
		7.5pF	±0.05pF	GRM0335C2A7R5WA01#			±0.25pF		GRM0335C2A8R8CA01#	
			±0.1pF	GRM0335C2A7R5BA01#			±0.5pF	GRM0335C2A8R8DA01#		
			±0.25pF	GRM0335C2A7R5CA01#			8.9pF	±0.05pF	GRM0335C2A8R9WA01#	
		±0.5pF	GRM0335C2A7R5DA01#	±0.1pF				GRM0335C2A8R9BA01#		
		7.6pF	±0.05pF	GRM0335C2A7R6WA01#				±0.25pF	GRM0335C2A8R9CA01#	
			±0.1pF	GRM0335C2A7R6BA01#			±0.5pF	GRM0335C2A8R9DA01#		
			±0.25pF	GRM0335C2A7R6CA01#			9.0pF	±0.05pF	GRM0335C2A9R0WA01#	
		±0.5pF	GRM0335C2A7R6DA01#	±0.1pF				GRM0335C2A9R0BA01#		
		7.7pF	±0.05pF	GRM0335C2A7R7WA01#				±0.25pF	GRM0335C2A9R0CA01#	
			±0.1pF	GRM0335C2A7R7BA01#			±0.5pF	GRM0335C2A9R0DA01#		
			±0.25pF	GRM0335C2A7R7CA01#			9.1pF	±0.05pF	GRM0335C2A9R1WA01#	
		±0.5pF	GRM0335C2A7R7DA01#	±0.1pF				GRM0335C2A9R1BA01#		
		7.8pF	±0.05pF	GRM0335C2A7R8WA01#				±0.25pF	GRM0335C2A9R1CA01#	
			±0.1pF	GRM0335C2A7R8BA01#			±0.5pF	GRM0335C2A9R1DA01#		
			±0.25pF	GRM0335C2A7R8CA01#			9.2pF	±0.05pF	GRM0335C2A9R2WA01#	
		±0.5pF	GRM0335C2A7R8DA01#	±0.1pF				GRM0335C2A9R2BA01#		
		7.9pF	±0.05pF	GRM0335C2A7R9WA01#				±0.25pF	GRM0335C2A9R2CA01#	
			±0.1pF	GRM0335C2A7R9BA01#			±0.5pF	GRM0335C2A9R2DA01#		
			±0.25pF	GRM0335C2A7R9CA01#			9.3pF	±0.05pF	GRM0335C2A9R3WA01#	
		±0.5pF	GRM0335C2A7R9DA01#	±0.1pF				GRM0335C2A9R3BA01#		
		8.0pF	±0.05pF	GRM0335C2A8R0WA01#				±0.25pF	GRM0335C2A9R3CA01#	
			±0.1pF	GRM0335C2A8R0BA01#			±0.5pF	GRM0335C2A9R3DA01#		
			±0.25pF	GRM0335C2A8R0CA01#			9.4pF	±0.05pF	GRM0335C2A9R4WA01#	
		±0.5pF	GRM0335C2A8R0DA01#	±0.1pF				GRM0335C2A9R4BA01#		
		8.1pF	±0.05pF	GRM0335C2A8R1WA01#				±0.25pF	GRM0335C2A9R4CA01#	
			±0.1pF	GRM0335C2A8R1BA01#			±0.5pF	GRM0335C2A9R4DA01#		
			±0.25pF	GRM0335C2A8R1CA01#			9.5pF	±0.05pF	GRM0335C2A9R5WA01#	
		±0.5pF	GRM0335C2A8R1DA01#	±0.1pF				GRM0335C2A9R5BA01#		
		8.2pF	±0.05pF	GRM0335C2A8R2WA01#				±0.25pF	GRM0335C2A9R5CA01#	
			±0.1pF	GRM0335C2A8R2BA01#			±0.5pF	GRM0335C2A9R5DA01#		
			±0.25pF	GRM0335C2A8R2CA01#			9.6pF	±0.05pF	GRM0335C2A9R6WA01#	
		±0.5pF	GRM0335C2A8R2DA01#	±0.1pF				GRM0335C2A9R6BA01#		
		8.3pF	±0.05pF	GRM0335C2A8R3WA01#				±0.25pF	GRM0335C2A9R6CA01#	
			±0.1pF	GRM0335C2A8R3BA01#			±0.5pF	GRM0335C2A9R6DA01#		
			±0.25pF	GRM0335C2A8R3CA01#			9.7pF	±0.05pF	GRM0335C2A9R7WA01#	
		±0.5pF	GRM0335C2A8R3DA01#	±0.1pF				GRM0335C2A9R7BA01#		
		8.4pF	±0.05pF	GRM0335C2A8R4WA01#				±0.25pF	GRM0335C2A9R7CA01#	
			±0.1pF	GRM0335C2A8R4BA01#			±0.5pF	GRM0335C2A9R7DA01#		
			±0.25pF	GRM0335C2A8R4CA01#			9.8pF	±0.05pF	GRM0335C2A9R8WA01#	
		±0.5pF	GRM0335C2A8R4DA01#	±0.1pF				GRM0335C2A9R8BA01#		
		8.5pF	±0.05pF	GRM0335C2A8R5WA01#				±0.25pF	GRM0335C2A9R8CA01#	
			±0.1pF	GRM0335C2A8R5BA01#			±0.5pF	GRM0335C2A9R8DA01#		
			±0.25pF	GRM0335C2A8R5CA01#			9.9pF	±0.05pF	GRM0335C2A9R9WA01#	
		±0.5pF	GRM0335C2A8R5DA01#	±0.1pF				GRM0335C2A9R9BA01#		
		8.6pF	±0.05pF	GRM0335C2A8R6WA01#				±0.25pF	GRM0335C2A9R9CA01#	
			±0.1pF	GRM0335C2A8R6BA01#			±0.5pF	GRM0335C2A9R9DA01#		
			±0.25pF	GRM0335C2A8R6CA01#			10pF	±1%	GRM0335C2A100FA01#	
		±0.5pF	GRM0335C2A8R6DA01#	±2%				GRM0335C2A100GA01#		
		8.7pF	±0.05pF	GRM0335C2A8R7WA01#				±5%	GRM0335C2A100JA01#	
			±0.1pF	GRM0335C2A8R7BA01#			11pF	±2%	GRM0335C2A110GA01#	
			±0.25pF	GRM0335C2A8R7CA01#				±5%	GRM0335C2A110JA01#	

Part number # indicates the package specification code.

GRM
 GR3
 GRJ
 GR4
 GJM
 GQM
 GA2
 GA3 GB
 GA3 GD
 GA3 GF
 LLL
 LLA
 LLM
 LLR
 NFM
 GJ4
 ZRA
 ZRB
 KRM
 KR3
 GMA
 GMD
 △Caution /Notice

GRM Series Temperature Compensating Type Part Number List

(→ 0.6×0.3mm)

Rated Voltage	TC Code	Cap.	Tol.	Part Number	Rated Voltage	TC Code	Cap.	Tol.	Part Number
100Vdc	COG	12pF	±1%	GRM0335C2A120FA01#	100Vdc	CH	4.2pF	±0.05pF	GRM0332C2A4R2WA01#
			±2%	GRM0335C2A120GA01#				±0.1pF	GRM0332C2A4R2BA01#
			±5%	GRM0335C2A120JA01#				±0.25pF	GRM0332C2A4R2CA01#
		13pF	±2%	GRM0335C2A130GA01#			4.3pF	±0.05pF	GRM0332C2A4R3WA01#
			±5%	GRM0335C2A130JA01#				±0.1pF	GRM0332C2A4R3BA01#
		15pF	±1%	GRM0335C2A150FA01#			4.4pF	±0.25pF	GRM0332C2A4R3CA01#
			±2%	GRM0335C2A150GA01#				±0.05pF	GRM0332C2A4R4WA01#
			±5%	GRM0335C2A150JA01#				±0.1pF	GRM0332C2A4R4BA01#
		16pF	±2%	GRM0335C2A160GA01#			4.5pF	±0.25pF	GRM0332C2A4R4CA01#
			±5%	GRM0335C2A160JA01#				±0.05pF	GRM0332C2A4R5WA01#
			±2%	GRM0335C2A180GA01#				±0.1pF	GRM0332C2A4R5BA01#
		18pF	±5%	GRM0335C2A180JA01#			4.6pF	±0.25pF	GRM0332C2A4R5CA01#
			±2%	GRM0335C2A200GA01#				±0.05pF	GRM0332C2A4R6WA01#
			±5%	GRM0335C2A200JA01#				±0.1pF	GRM0332C2A4R6BA01#
		22pF	±2%	GRM0335C2A220GA01#			4.7pF	±0.25pF	GRM0332C2A4R6CA01#
			±5%	GRM0335C2A220JA01#				±0.05pF	GRM0332C2A4R7WA01#
		24pF	±2%	GRM0335C2A240GA01#			4.8pF	±0.1pF	GRM0332C2A4R7BA01#
			±5%	GRM0335C2A240JA01#				±0.25pF	GRM0332C2A4R7CA01#
		27pF	±2%	GRM0335C2A270GA01#			4.9pF	±0.05pF	GRM0332C2A4R8WA01#
			±5%	GRM0335C2A270JA01#				±0.1pF	GRM0332C2A4R8BA01#
		30pF	±2%	GRM0335C2A300GA01#			5.0pF	±0.25pF	GRM0332C2A4R8CA01#
			±5%	GRM0335C2A300JA01#				±0.05pF	GRM0332C2A5R0WA01#
		33pF	±2%	GRM0335C2A330GA01#			5.1pF	±0.1pF	GRM0332C2A5R0BA01#
			±5%	GRM0335C2A330JA01#				±0.25pF	GRM0332C2A5R0CA01#
		36pF	±2%	GRM0335C2A360GA01#			5.2pF	±0.05pF	GRM0332C2A5R1WA01#
			±5%	GRM0335C2A360JA01#				±0.1pF	GRM0332C2A5R1BA01#
		39pF	±2%	GRM0335C2A390GA01#			5.3pF	±0.25pF	GRM0332C2A5R1CA01#
			±5%	GRM0335C2A390JA01#				±0.05pF	GRM0332C2A5R2WA01#
		43pF	±2%	GRM0335C2A430GA01#			5.4pF	±0.1pF	GRM0332C2A5R2BA01#
			±5%	GRM0335C2A430JA01#				±0.25pF	GRM0332C2A5R2CA01#
		47pF	±2%	GRM0335C2A470GA01#			5.5pF	±0.5pF	GRM0332C2A5R2DA01#
			±5%	GRM0335C2A470JA01#				±0.05pF	GRM0332C2A5R3WA01#
		51pF	±2%	GRM0335C2A510GA01#			5.6pF	±0.1pF	GRM0332C2A5R3BA01#
			±5%	GRM0335C2A510JA01#				±0.25pF	GRM0332C2A5R3CA01#
		56pF	±2%	GRM0335C2A560GA01#			5.7pF	±0.5pF	GRM0332C2A5R3DA01#
			±5%	GRM0335C2A560JA01#				±0.05pF	GRM0332C2A5R4WA01#
		62pF	±2%	GRM0335C2A620GA01#			5.8pF	±0.1pF	GRM0332C2A5R4BA01#
			±5%	GRM0335C2A620JA01#				±0.25pF	GRM0332C2A5R4CA01#
		68pF	±2%	GRM0335C2A680GA01#			5.9pF	±0.5pF	GRM0332C2A5R4DA01#
			±5%	GRM0335C2A680JA01#				±0.05pF	GRM0332C2A5R5WA01#
		75pF	±2%	GRM0335C2A750GA01#			6.0pF	±0.1pF	GRM0332C2A5R5BA01#
			±5%	GRM0335C2A750JA01#				±0.25pF	GRM0332C2A5R5CA01#
		82pF	±2%	GRM0335C2A820GA01#			6.1pF	±0.5pF	GRM0332C2A5R5DA01#
			±5%	GRM0335C2A820JA01#				±0.05pF	GRM0332C2A5R6WA01#
		91pF	±2%	GRM0335C2A910GA01#			6.2pF	±0.1pF	GRM0332C2A5R6BA01#
			±5%	GRM0335C2A910JA01#				±0.25pF	GRM0332C2A5R6CA01#
		100pF	±2%	GRM0335C2A101GA01#			6.3pF	±0.5pF	GRM0332C2A5R6DA01#
			±5%	GRM0335C2A101JA01#				±0.05pF	GRM0332C2A5R7WA01#
	CH	4.0pF	±0.05pF	GRM0332C2A4R0WA01#	6.4pF	±0.1pF	GRM0332C2A5R7BA01#		
			±0.1pF	GRM0332C2A4R0BA01#		±0.25pF	GRM0332C2A5R7CA01#		
			±0.25pF	GRM0332C2A4R0CA01#		±0.05pF	GRM0332C2A5R7WA01#		
		±0.05pF	GRM0332C2A4R1WA01#	±0.1pF		GRM0332C2A5R7BA01#			
4.1pF	±0.1pF	GRM0332C2A4R1BA01#	6.5pF	±0.25pF	GRM0332C2A5R7CA01#				
	±0.25pF	GRM0332C2A4R1CA01#		±0.05pF	GRM0332C2A5R7WA01#				
	±0.05pF	GRM0332C2A4R1WA01#		±0.1pF	GRM0332C2A5R7BA01#				
				6.6pF	±0.25pF	GRM0332C2A5R7CA01#			

Part number # indicates the package specification code.

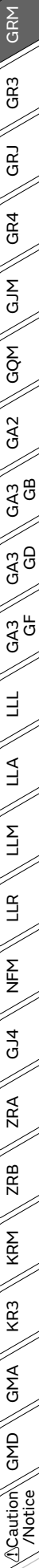

GRM Series Temperature Compensating Type Part Number List

(→ 0.6×0.3mm)

Rated Voltage	TC Code	Cap.	Tol.	Part Number	Rated Voltage	TC Code	Cap.	Tol.	Part Number
100Vdc	CH	5.7pF	±0.5pF	GRM0332C2A5R7DA01#	100Vdc	CH	7.1pF	±0.1pF	GRM0332C2A7R1BA01#
			±0.05pF	GRM0332C2A5R8WA01#				±0.25pF	GRM0332C2A7R1CA01#
			±0.1pF	GRM0332C2A5R8BA01#				±0.5pF	GRM0332C2A7R1DA01#
			±0.25pF	GRM0332C2A5R8CA01#				7.2pF	±0.05pF
		±0.5pF	GRM0332C2A5R8DA01#	±0.1pF			GRM0332C2A7R2BA01#		
		5.9pF	±0.05pF	GRM0332C2A5R9WA01#			±0.25pF		GRM0332C2A7R2CA01#
			±0.1pF	GRM0332C2A5R9BA01#			±0.5pF		GRM0332C2A7R2DA01#
			±0.25pF	GRM0332C2A5R9CA01#			7.3pF	±0.05pF	GRM0332C2A7R3WA01#
			±0.5pF	GRM0332C2A5R9DA01#				±0.1pF	GRM0332C2A7R3BA01#
		6.0pF	±0.05pF	GRM0332C2A6R0WA01#				±0.25pF	GRM0332C2A7R3CA01#
			±0.1pF	GRM0332C2A6R0BA01#				±0.5pF	GRM0332C2A7R3DA01#
			±0.25pF	GRM0332C2A6R0CA01#			7.4pF	±0.05pF	GRM0332C2A7R4WA01#
			±0.5pF	GRM0332C2A6R0DA01#				±0.1pF	GRM0332C2A7R4BA01#
		6.1pF	±0.05pF	GRM0332C2A6R1WA01#				±0.25pF	GRM0332C2A7R4CA01#
			±0.1pF	GRM0332C2A6R1BA01#				±0.5pF	GRM0332C2A7R4DA01#
			±0.25pF	GRM0332C2A6R1CA01#			7.5pF	±0.05pF	GRM0332C2A7R5WA01#
			±0.5pF	GRM0332C2A6R1DA01#				±0.1pF	GRM0332C2A7R5BA01#
		6.2pF	±0.05pF	GRM0332C2A6R2WA01#				±0.25pF	GRM0332C2A7R5CA01#
			±0.1pF	GRM0332C2A6R2BA01#				±0.5pF	GRM0332C2A7R5DA01#
			±0.25pF	GRM0332C2A6R2CA01#			7.6pF	±0.05pF	GRM0332C2A7R6WA01#
			±0.5pF	GRM0332C2A6R2DA01#				±0.1pF	GRM0332C2A7R6BA01#
		6.3pF	±0.05pF	GRM0332C2A6R3WA01#				±0.25pF	GRM0332C2A7R6CA01#
			±0.1pF	GRM0332C2A6R3BA01#				±0.5pF	GRM0332C2A7R6DA01#
			±0.25pF	GRM0332C2A6R3CA01#			7.7pF	±0.05pF	GRM0332C2A7R7WA01#
			±0.5pF	GRM0332C2A6R3DA01#				±0.1pF	GRM0332C2A7R7BA01#
		6.4pF	±0.05pF	GRM0332C2A6R4WA01#				±0.25pF	GRM0332C2A7R7CA01#
			±0.1pF	GRM0332C2A6R4BA01#				±0.5pF	GRM0332C2A7R7DA01#
			±0.25pF	GRM0332C2A6R4CA01#			7.8pF	±0.05pF	GRM0332C2A7R8WA01#
			±0.5pF	GRM0332C2A6R4DA01#				±0.1pF	GRM0332C2A7R8BA01#
		6.5pF	±0.05pF	GRM0332C2A6R5WA01#				±0.25pF	GRM0332C2A7R8CA01#
			±0.1pF	GRM0332C2A6R5BA01#				±0.5pF	GRM0332C2A7R8DA01#
			±0.25pF	GRM0332C2A6R5CA01#			7.9pF	±0.05pF	GRM0332C2A7R9WA01#
			±0.5pF	GRM0332C2A6R5DA01#				±0.1pF	GRM0332C2A7R9BA01#
		6.6pF	±0.05pF	GRM0332C2A6R6WA01#				±0.25pF	GRM0332C2A7R9CA01#
			±0.1pF	GRM0332C2A6R6BA01#				±0.5pF	GRM0332C2A7R9DA01#
			±0.25pF	GRM0332C2A6R6CA01#			8.0pF	±0.05pF	GRM0332C2A8R0WA01#
			±0.5pF	GRM0332C2A6R6DA01#				±0.1pF	GRM0332C2A8R0BA01#
		6.7pF	±0.05pF	GRM0332C2A6R7WA01#				±0.25pF	GRM0332C2A8R0CA01#
			±0.1pF	GRM0332C2A6R7BA01#				±0.5pF	GRM0332C2A8R0DA01#
			±0.25pF	GRM0332C2A6R7CA01#			8.1pF	±0.05pF	GRM0332C2A8R1WA01#
			±0.5pF	GRM0332C2A6R7DA01#				±0.1pF	GRM0332C2A8R1BA01#
		6.8pF	±0.05pF	GRM0332C2A6R8WA01#				±0.25pF	GRM0332C2A8R1CA01#
			±0.1pF	GRM0332C2A6R8BA01#				±0.5pF	GRM0332C2A8R1DA01#
			±0.25pF	GRM0332C2A6R8CA01#			8.2pF	±0.05pF	GRM0332C2A8R2WA01#
			±0.5pF	GRM0332C2A6R8DA01#				±0.1pF	GRM0332C2A8R2BA01#
		6.9pF	±0.05pF	GRM0332C2A6R9WA01#				±0.25pF	GRM0332C2A8R2CA01#
			±0.1pF	GRM0332C2A6R9BA01#				±0.5pF	GRM0332C2A8R2DA01#
			±0.25pF	GRM0332C2A6R9CA01#			8.3pF	±0.05pF	GRM0332C2A8R3WA01#
			±0.5pF	GRM0332C2A6R9DA01#				±0.1pF	GRM0332C2A8R3BA01#
		7.0pF	±0.05pF	GRM0332C2A7R0WA01#				±0.25pF	GRM0332C2A8R3CA01#
			±0.1pF	GRM0332C2A7R0BA01#				±0.5pF	GRM0332C2A8R3DA01#
			±0.25pF	GRM0332C2A7R0CA01#			8.4pF	±0.05pF	GRM0332C2A8R4WA01#
			±0.5pF	GRM0332C2A7R0DA01#				±0.1pF	GRM0332C2A8R4BA01#
		7.1pF	±0.05pF	GRM0332C2A7R1WA01#				±0.25pF	GRM0332C2A8R4CA01#

- GRM
- GR3
- GRJ
- GR4
- GJM
- GQM
- GA2
- GA3 GB
- GA3 GD
- GA3 GF
- LLL
- LLA
- LLM
- LLR
- NFM
- GJ4
- ZRA
- ZRB
- KRM
- KR3
- GMA
- GMD
- ⚠Caution /Notice

Part number # indicates the package specification code.

GRM Series Temperature Compensating Type Part Number List

(→ 0.6×0.3mm)

Rated Voltage	TC Code	Cap.	Tol.	Part Number	Rated Voltage	TC Code	Cap.	Tol.	Part Number
100Vdc	CH	8.4pF	±0.5pF	GRM0332C2A8R4DA01#	100Vdc	CH	9.8pF	±0.1pF	GRM0332C2A9R8BA01#
			±0.05pF	GRM0332C2A8R5WA01#				±0.25pF	GRM0332C2A9R8CA01#
			±0.1pF	GRM0332C2A8R5BA01#				±0.5pF	GRM0332C2A9R8DA01#
			±0.25pF	GRM0332C2A8R5CA01#				9.9pF	±0.05pF
		±0.5pF	GRM0332C2A8R5DA01#	±0.1pF			GRM0332C2A9R9BA01#		
		8.6pF	±0.05pF	GRM0332C2A8R6WA01#			±0.25pF		GRM0332C2A9R9CA01#
			±0.1pF	GRM0332C2A8R6BA01#			±0.5pF		GRM0332C2A9R9DA01#
			±0.25pF	GRM0332C2A8R6CA01#			10pF	±2%	GRM0332C2A100GA01#
			±0.5pF	GRM0332C2A8R6DA01#				±5%	GRM0332C2A100JA01#
		8.7pF	±0.05pF	GRM0332C2A8R7WA01#			11pF	±2%	GRM0332C2A110GA01#
			±0.1pF	GRM0332C2A8R7BA01#				±5%	GRM0332C2A110JA01#
			±0.25pF	GRM0332C2A8R7CA01#			12pF	±2%	GRM0332C2A120GA01#
			±0.5pF	GRM0332C2A8R7DA01#				±5%	GRM0332C2A120JA01#
		8.8pF	±0.05pF	GRM0332C2A8R8WA01#			13pF	±2%	GRM0332C2A130GA01#
			±0.1pF	GRM0332C2A8R8BA01#				±5%	GRM0332C2A130JA01#
			±0.25pF	GRM0332C2A8R8CA01#			15pF	±2%	GRM0332C2A150GA01#
			±0.5pF	GRM0332C2A8R8DA01#				±5%	GRM0332C2A150JA01#
		8.9pF	±0.05pF	GRM0332C2A8R9WA01#			16pF	±2%	GRM0332C2A160GA01#
			±0.1pF	GRM0332C2A8R9BA01#				±5%	GRM0332C2A160JA01#
			±0.25pF	GRM0332C2A8R9CA01#			18pF	±2%	GRM0332C2A180GA01#
			±0.5pF	GRM0332C2A8R9DA01#				±5%	GRM0332C2A180JA01#
		9.0pF	±0.05pF	GRM0332C2A9R0WA01#			20pF	±2%	GRM0332C2A200GA01#
			±0.1pF	GRM0332C2A9R0BA01#				±5%	GRM0332C2A200JA01#
			±0.25pF	GRM0332C2A9R0CA01#			22pF	±2%	GRM0332C2A220GA01#
			±0.5pF	GRM0332C2A9R0DA01#				±5%	GRM0332C2A220JA01#
		9.1pF	±0.05pF	GRM0332C2A9R1WA01#			24pF	±2%	GRM0332C2A240GA01#
			±0.1pF	GRM0332C2A9R1BA01#				±5%	GRM0332C2A240JA01#
			±0.25pF	GRM0332C2A9R1CA01#			27pF	±2%	GRM0332C2A270GA01#
			±0.5pF	GRM0332C2A9R1DA01#				±5%	GRM0332C2A270JA01#
		9.2pF	±0.05pF	GRM0332C2A9R2WA01#			30pF	±2%	GRM0332C2A300GA01#
			±0.1pF	GRM0332C2A9R2BA01#				±5%	GRM0332C2A300JA01#
			±0.25pF	GRM0332C2A9R2CA01#			33pF	±2%	GRM0332C2A330GA01#
			±0.5pF	GRM0332C2A9R2DA01#				±5%	GRM0332C2A330JA01#
		9.3pF	±0.05pF	GRM0332C2A9R3WA01#			36pF	±2%	GRM0332C2A360GA01#
			±0.1pF	GRM0332C2A9R3BA01#				±5%	GRM0332C2A360JA01#
			±0.25pF	GRM0332C2A9R3CA01#			39pF	±2%	GRM0332C2A390GA01#
			±0.5pF	GRM0332C2A9R3DA01#				±5%	GRM0332C2A390JA01#
		9.4pF	±0.05pF	GRM0332C2A9R4WA01#			43pF	±2%	GRM0332C2A430GA01#
			±0.1pF	GRM0332C2A9R4BA01#				±5%	GRM0332C2A430JA01#
			±0.25pF	GRM0332C2A9R4CA01#			47pF	±2%	GRM0332C2A470GA01#
			±0.5pF	GRM0332C2A9R4DA01#				±5%	GRM0332C2A470JA01#
		9.5pF	±0.05pF	GRM0332C2A9R5WA01#			51pF	±2%	GRM0332C2A510GA01#
			±0.1pF	GRM0332C2A9R5BA01#				±5%	GRM0332C2A510JA01#
			±0.25pF	GRM0332C2A9R5CA01#			56pF	±2%	GRM0332C2A560GA01#
			±0.5pF	GRM0332C2A9R5DA01#				±5%	GRM0332C2A560JA01#
		9.6pF	±0.05pF	GRM0332C2A9R6WA01#			62pF	±2%	GRM0332C2A620GA01#
			±0.1pF	GRM0332C2A9R6BA01#				±5%	GRM0332C2A620JA01#
			±0.25pF	GRM0332C2A9R6CA01#			68pF	±2%	GRM0332C2A680GA01#
			±0.5pF	GRM0332C2A9R6DA01#				±5%	GRM0332C2A680JA01#
		9.7pF	±0.05pF	GRM0332C2A9R7WA01#			75pF	±2%	GRM0332C2A750GA01#
			±0.1pF	GRM0332C2A9R7BA01#				±5%	GRM0332C2A750JA01#
			±0.25pF	GRM0332C2A9R7CA01#			82pF	±2%	GRM0332C2A820GA01#
			±0.5pF	GRM0332C2A9R7DA01#				±5%	GRM0332C2A820JA01#
		9.8pF	±0.05pF	GRM0332C2A9R8WA01#			91pF	±2%	GRM0332C2A910GA01#

Part number # indicates the package specification code.

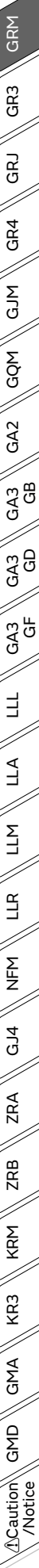

GRM Series Temperature Compensating Type Part Number List

(→ 0.6×0.3mm)

Rated Voltage	TC Code	Cap.	Tol.	Part Number	Rated Voltage	TC Code	Cap.	Tol.	Part Number		
100Vdc	CH	91pF	±5%	GRM0332C2A910JA01#	100Vdc	CJ	3.8pF	±0.05pF	GRM0333C2A3R8WA01#		
		100pF	±2%	GRM0332C2A101GA01#				±0.1pF	GRM0333C2A3R8BA01#		
			±5%	GRM0332C2A101JA01#				±0.25pF	GRM0333C2A3R8CA01#		
	CJ	2.1pF	±0.05pF	GRM0333C2A2R1WA01#			3.9pF	±0.05pF	GRM0333C2A3R9WA01#		
			±0.1pF	GRM0333C2A2R1BA01#				±0.1pF	GRM0333C2A3R9BA01#		
			±0.25pF	GRM0333C2A2R1CA01#				±0.25pF	GRM0333C2A3R9CA01#		
		2.2pF	±0.05pF	GRM0333C2A2R2WA01#			CK	0.10pF	±0.05pF	GRM0334C2AR10WA01#	
			±0.1pF	GRM0333C2A2R2BA01#					0.20pF	±0.05pF	GRM0334C2AR20WA01#
			±0.25pF	GRM0333C2A2R2CA01#						±0.1pF	GRM0334C2AR20BA01#
		2.3pF	±0.05pF	GRM0333C2A2R3WA01#				0.30pF		±0.05pF	GRM0334C2AR30WA01#
			±0.1pF	GRM0333C2A2R3BA01#					±0.1pF	GRM0334C2AR30BA01#	
			±0.25pF	GRM0333C2A2R3CA01#					0.40pF	±0.05pF	GRM0334C2AR40WA01#
		2.4pF	±0.05pF	GRM0333C2A2R4WA01#				±0.1pF		GRM0334C2AR40BA01#	
			±0.1pF	GRM0333C2A2R4BA01#				0.50pF		±0.05pF	GRM0334C2AR50WA01#
			±0.25pF	GRM0333C2A2R4CA01#					±0.1pF	GRM0334C2AR50BA01#	
		2.5pF	±0.05pF	GRM0333C2A2R5WA01#					0.60pF	±0.05pF	GRM0334C2AR60WA01#
			±0.1pF	GRM0333C2A2R5BA01#				±0.1pF		GRM0334C2AR60BA01#	
			±0.25pF	GRM0333C2A2R5CA01#				0.70pF		±0.05pF	GRM0334C2AR70WA01#
		2.6pF	±0.05pF	GRM0333C2A2R6WA01#					±0.1pF	GRM0334C2AR70BA01#	
			±0.1pF	GRM0333C2A2R6BA01#					0.80pF	±0.05pF	GRM0334C2AR80WA01#
			±0.25pF	GRM0333C2A2R6CA01#				±0.1pF		GRM0334C2AR80BA01#	
		2.7pF	±0.05pF	GRM0333C2A2R7WA01#				0.90pF		±0.05pF	GRM0334C2AR90WA01#
			±0.1pF	GRM0333C2A2R7BA01#					±0.1pF	GRM0334C2AR90BA01#	
			±0.25pF	GRM0333C2A2R7CA01#					1.0pF	±0.05pF	GRM0334C2A1R0WA01#
		2.8pF	±0.05pF	GRM0333C2A2R8WA01#				±0.1pF		GRM0334C2A1R0BA01#	
			±0.1pF	GRM0333C2A2R8BA01#				±0.25pF		GRM0334C2A1R0CA01#	
			±0.25pF	GRM0333C2A2R8CA01#				1.1pF	±0.05pF	GRM0334C2A1R1WA01#	
		2.9pF	±0.05pF	GRM0333C2A2R9WA01#		±0.1pF			GRM0334C2A1R1BA01#		
			±0.1pF	GRM0333C2A2R9BA01#		±0.25pF			GRM0334C2A1R1CA01#		
			±0.25pF	GRM0333C2A2R9CA01#		1.2pF		±0.05pF	GRM0334C2A1R2WA01#		
	3.0pF	±0.05pF	GRM0333C2A3R0WA01#	±0.1pF				GRM0334C2A1R2BA01#			
		±0.1pF	GRM0333C2A3R0BA01#	±0.25pF				GRM0334C2A1R2CA01#			
		±0.25pF	GRM0333C2A3R0CA01#	1.3pF		±0.05pF		GRM0334C2A1R3WA01#			
	3.1pF	±0.05pF	GRM0333C2A3R1WA01#			±0.1pF	GRM0334C2A1R3BA01#				
		±0.1pF	GRM0333C2A3R1BA01#			±0.25pF	GRM0334C2A1R3CA01#				
		±0.25pF	GRM0333C2A3R1CA01#	1.4pF		±0.05pF	GRM0334C2A1R4WA01#				
	3.2pF	±0.05pF	GRM0333C2A3R2WA01#			±0.1pF	GRM0334C2A1R4BA01#				
		±0.1pF	GRM0333C2A3R2BA01#			±0.25pF	GRM0334C2A1R4CA01#				
		±0.25pF	GRM0333C2A3R2CA01#	1.5pF		±0.05pF	GRM0334C2A1R5WA01#				
	3.3pF	±0.05pF	GRM0333C2A3R3WA01#			±0.1pF	GRM0334C2A1R5BA01#				
		±0.1pF	GRM0333C2A3R3BA01#			±0.25pF	GRM0334C2A1R5CA01#				
		±0.25pF	GRM0333C2A3R3CA01#	1.6pF		±0.05pF	GRM0334C2A1R6WA01#				
	3.4pF	±0.05pF	GRM0333C2A3R4WA01#			±0.1pF	GRM0334C2A1R6BA01#				
		±0.1pF	GRM0333C2A3R4BA01#			±0.25pF	GRM0334C2A1R6CA01#				
		±0.25pF	GRM0333C2A3R4CA01#	1.7pF		±0.05pF	GRM0334C2A1R7WA01#				
	3.5pF	±0.05pF	GRM0333C2A3R5WA01#			±0.1pF	GRM0334C2A1R7BA01#				
		±0.1pF	GRM0333C2A3R5BA01#			±0.25pF	GRM0334C2A1R7CA01#				
		±0.25pF	GRM0333C2A3R5CA01#	1.8pF		±0.05pF	GRM0334C2A1R8WA01#				
	3.6pF	±0.05pF	GRM0333C2A3R6WA01#			±0.1pF	GRM0334C2A1R8BA01#				
		±0.1pF	GRM0333C2A3R6BA01#			±0.25pF	GRM0334C2A1R8CA01#				
		±0.25pF	GRM0333C2A3R6CA01#	1.9pF		±0.05pF	GRM0334C2A1R9WA01#				
	3.7pF	±0.05pF	GRM0333C2A3R7WA01#			±0.1pF	GRM0334C2A1R9BA01#				
		±0.1pF	GRM0333C2A3R7BA01#			±0.25pF	GRM0334C2A1R9CA01#				
		±0.25pF	GRM0333C2A3R7CA01#	2.0pF		±0.05pF	GRM0334C2A2R0WA01#				

Part number # indicates the package specification code.



GRM Series Temperature Compensating Type Part Number List

(→ 0.6×0.3mm)

Rated Voltage	TC Code	Cap.	Tol.	Part Number	Rated Voltage	TC Code	Cap.	Tol.	Part Number		
100Vdc	CK	2.0pF	±0.1pF	GRM0334C2A2R0BA01#	50Vdc	COG	2.1pF	±0.25pF	GRM0335C1H2R1CA01#		
			±0.25pF	GRM0334C2A2R0CA01#				±0.05pF	GRM0335C1H2R2WA01#		
50Vdc	COG	0.10pF	±0.05pF	GRM0335C1HR10WA01#				±0.1pF	GRM0335C1H2R2BA01#		
			±0.05pF	GRM0335C1HR20WA01#				±0.25pF	GRM0335C1H2R2CA01#		
			±0.1pF	GRM0335C1HR20BA01#				2.3pF	±0.05pF	GRM0335C1H2R3WA01#	
		±0.05pF	GRM0335C1HR30WA01#	±0.1pF	GRM0335C1H2R3BA01#						
		±0.1pF	GRM0335C1HR30BA01#	±0.25pF	GRM0335C1H2R3CA01#						
		0.40pF	±0.05pF	GRM0335C1HR40WA01#					±0.05pF	GRM0335C1H2R4WA01#	
			±0.1pF	GRM0335C1HR40BA01#					±0.1pF	GRM0335C1H2R4BA01#	
			±0.25pF	GRM0335C1HR50WA01#					±0.25pF	GRM0335C1H2R4CA01#	
		0.50pF	±0.05pF	GRM0335C1HR50WA01#					±0.05pF	GRM0335C1H2R5WA01#	
			±0.1pF	GRM0335C1HR50BA01#					±0.1pF	GRM0335C1H2R5BA01#	
		0.60pF	±0.05pF	GRM0335C1HR60WA01#					±0.1pF	GRM0335C1H2R5CA01#	
			±0.1pF	GRM0335C1HR60BA01#					2.6pF	±0.05pF	GRM0335C1H2R6WA01#
			±0.25pF	GRM0335C1HR70WA01#						±0.1pF	GRM0335C1H2R6BA01#
		±0.05pF	GRM0335C1HR80WA01#	±0.25pF	GRM0335C1H2R6CA01#						
		0.80pF	±0.05pF	GRM0335C1HR80WA01#					±0.1pF	GRM0335C1H2R7WA01#	
			±0.1pF	GRM0335C1HR80BA01#					±0.1pF	GRM0335C1H2R7BA01#	
			±0.25pF	GRM0335C1HR90WA01#					±0.25pF	GRM0335C1H2R7CA01#	
		0.90pF	±0.05pF	GRM0335C1HR90WA01#					±0.1pF	GRM0335C1H2R7BA01#	
			±0.1pF	GRM0335C1HR90BA01#					±0.05pF	GRM0335C1H2R8WA01#	
			±0.25pF	GRM0335C1H1R0WA01#					±0.1pF	GRM0335C1H2R8BA01#	
		1.0pF	±0.05pF	GRM0335C1H1R0WA01#					±0.1pF	GRM0335C1H2R8BA01#	
			±0.1pF	GRM0335C1H1R0BA01#					±0.25pF	GRM0335C1H2R8CA01#	
			±0.25pF	GRM0335C1H1R0CA01#					2.9pF	±0.05pF	GRM0335C1H2R9WA01#
		±0.05pF	GRM0335C1H1R1WA01#	±0.1pF	GRM0335C1H2R9BA01#						
		±0.1pF	GRM0335C1H1R1BA01#	±0.25pF	GRM0335C1H2R9CA01#						
		1.1pF	±0.05pF	GRM0335C1H1R1WA01#					±0.1pF	GRM0335C1H3R0WA01#	
			±0.1pF	GRM0335C1H1R1BA01#					±0.1pF	GRM0335C1H3R0BA01#	
			±0.25pF	GRM0335C1H1R1CA01#					±0.25pF	GRM0335C1H3R0CA01#	
		1.2pF	±0.05pF	GRM0335C1H1R2WA01#					±0.1pF	GRM0335C1H3R0BA01#	
			±0.1pF	GRM0335C1H1R2BA01#					±0.05pF	GRM0335C1H3R1WA01#	
			±0.25pF	GRM0335C1H1R2CA01#					±0.1pF	GRM0335C1H3R1BA01#	
		1.3pF	±0.05pF	GRM0335C1H1R3WA01#					±0.1pF	GRM0335C1H3R1BA01#	
			±0.1pF	GRM0335C1H1R3BA01#					±0.25pF	GRM0335C1H3R1CA01#	
			±0.25pF	GRM0335C1H1R3CA01#					3.2pF	±0.05pF	GRM0335C1H3R2WA01#
		±0.05pF	GRM0335C1H1R4WA01#	±0.1pF	GRM0335C1H3R2BA01#						
		±0.1pF	GRM0335C1H1R4BA01#	±0.25pF	GRM0335C1H3R2CA01#						
		1.4pF	±0.05pF	GRM0335C1H1R4WA01#					±0.1pF	GRM0335C1H3R2BA01#	
			±0.1pF	GRM0335C1H1R4BA01#					±0.05pF	GRM0335C1H3R3WA01#	
			±0.25pF	GRM0335C1H1R4CA01#					±0.1pF	GRM0335C1H3R3BA01#	
		1.5pF	±0.05pF	GRM0335C1H1R5WA01#					±0.1pF	GRM0335C1H3R3BA01#	
			±0.1pF	GRM0335C1H1R5BA01#					±0.25pF	GRM0335C1H3R3CA01#	
			±0.25pF	GRM0335C1H1R5CA01#					3.4pF	±0.05pF	GRM0335C1H3R4WA01#
		±0.05pF	GRM0335C1H1R6WA01#	±0.1pF	GRM0335C1H3R4BA01#						
		±0.1pF	GRM0335C1H1R6BA01#	±0.25pF	GRM0335C1H3R4CA01#						
		1.6pF	±0.05pF	GRM0335C1H1R6WA01#					±0.1pF	GRM0335C1H3R4BA01#	
			±0.1pF	GRM0335C1H1R6BA01#					±0.05pF	GRM0335C1H3R5WA01#	
			±0.25pF	GRM0335C1H1R6CA01#					±0.1pF	GRM0335C1H3R5BA01#	
		1.7pF	±0.05pF	GRM0335C1H1R7WA01#					±0.1pF	GRM0335C1H3R5BA01#	
±0.1pF	GRM0335C1H1R7BA01#		±0.25pF	GRM0335C1H3R5CA01#							
±0.25pF	GRM0335C1H1R7CA01#		3.6pF	±0.05pF					GRM0335C1H3R6WA01#		
±0.05pF	GRM0335C1H1R8WA01#	±0.1pF		GRM0335C1H3R6BA01#							
±0.1pF	GRM0335C1H1R8BA01#	±0.25pF		GRM0335C1H3R6CA01#							
1.8pF	±0.05pF	GRM0335C1H1R8WA01#					±0.1pF	GRM0335C1H3R6BA01#			
	±0.1pF	GRM0335C1H1R8BA01#					±0.05pF	GRM0335C1H3R7WA01#			
	±0.25pF	GRM0335C1H1R8CA01#					±0.1pF	GRM0335C1H3R7BA01#			
1.9pF	±0.05pF	GRM0335C1H1R9WA01#					±0.1pF	GRM0335C1H3R7BA01#			
	±0.1pF	GRM0335C1H1R9BA01#					±0.25pF	GRM0335C1H3R7CA01#			
	±0.25pF	GRM0335C1H1R9CA01#					3.8pF	±0.05pF	GRM0335C1H3R8WA01#		
±0.05pF	GRM0335C1H2R0WA01#	±0.1pF	GRM0335C1H3R8BA01#								
±0.1pF	GRM0335C1H2R0BA01#	±0.25pF	GRM0335C1H3R8CA01#								
2.0pF	±0.05pF	GRM0335C1H2R0WA01#					±0.1pF	GRM0335C1H3R8BA01#			
	±0.1pF	GRM0335C1H2R0BA01#					±0.05pF	GRM0335C1H3R9WA01#			
	±0.25pF	GRM0335C1H2R0CA01#					±0.1pF	GRM0335C1H3R9BA01#			
2.1pF	±0.05pF	GRM0335C1H2R1WA01#					±0.1pF	GRM0335C1H3R9BA01#			
	±0.1pF	GRM0335C1H2R1BA01#									

Part number # indicates the package specification code.



GRM Series Temperature Compensating Type Part Number List

(→ 0.6×0.3mm)

Rated Voltage	TC Code	Cap.	Tol.	Part Number	Rated Voltage	TC Code	Cap.	Tol.	Part Number
50Vdc	COG	3.9pF	±0.25pF	GRM0335C1H3R9CA01#	50Vdc	COG	5.6pF	±0.05pF	GRM0335C1H5R6WA01#
			±0.05pF	GRM0335C1H4R0WA01#				±0.1pF	GRM0335C1H5R6BA01#
			±0.1pF	GRM0335C1H4R0BA01#				±0.25pF	GRM0335C1H5R6CA01#
		±0.25pF	GRM0335C1H4R0CA01#	±0.5pF			GRM0335C1H5R6DA01#		
		4.1pF	±0.05pF	GRM0335C1H4R1WA01#			5.7pF	±0.05pF	GRM0335C1H5R7WA01#
			±0.1pF	GRM0335C1H4R1BA01#				±0.1pF	GRM0335C1H5R7BA01#
			±0.25pF	GRM0335C1H4R1CA01#				±0.25pF	GRM0335C1H5R7CA01#
		4.2pF	±0.05pF	GRM0335C1H4R2WA01#			5.8pF	±0.05pF	GRM0335C1H5R8WA01#
			±0.1pF	GRM0335C1H4R2BA01#				±0.1pF	GRM0335C1H5R8BA01#
			±0.25pF	GRM0335C1H4R2CA01#				±0.25pF	GRM0335C1H5R8CA01#
		4.3pF	±0.05pF	GRM0335C1H4R3WA01#			5.9pF	±0.05pF	GRM0335C1H5R9WA01#
			±0.1pF	GRM0335C1H4R3BA01#				±0.1pF	GRM0335C1H5R9BA01#
			±0.25pF	GRM0335C1H4R3CA01#				±0.25pF	GRM0335C1H5R9CA01#
		4.4pF	±0.05pF	GRM0335C1H4R4WA01#			6.0pF	±0.05pF	GRM0335C1H6R0WA01#
			±0.1pF	GRM0335C1H4R4BA01#				±0.1pF	GRM0335C1H6R0BA01#
			±0.25pF	GRM0335C1H4R4CA01#				±0.25pF	GRM0335C1H6R0CA01#
		4.5pF	±0.05pF	GRM0335C1H4R5WA01#			6.1pF	±0.05pF	GRM0335C1H6R1WA01#
			±0.1pF	GRM0335C1H4R5BA01#				±0.1pF	GRM0335C1H6R1BA01#
			±0.25pF	GRM0335C1H4R5CA01#				±0.25pF	GRM0335C1H6R1CA01#
		4.6pF	±0.05pF	GRM0335C1H4R6WA01#			6.2pF	±0.05pF	GRM0335C1H6R2WA01#
			±0.1pF	GRM0335C1H4R6BA01#				±0.1pF	GRM0335C1H6R2BA01#
			±0.25pF	GRM0335C1H4R6CA01#				±0.25pF	GRM0335C1H6R2CA01#
		4.7pF	±0.05pF	GRM0335C1H4R7WA01#			6.3pF	±0.05pF	GRM0335C1H6R3WA01#
			±0.1pF	GRM0335C1H4R7BA01#				±0.1pF	GRM0335C1H6R3BA01#
			±0.25pF	GRM0335C1H4R7CA01#				±0.25pF	GRM0335C1H6R3CA01#
		4.8pF	±0.05pF	GRM0335C1H4R8WA01#			6.4pF	±0.05pF	GRM0335C1H6R4WA01#
			±0.1pF	GRM0335C1H4R8BA01#				±0.1pF	GRM0335C1H6R4BA01#
			±0.25pF	GRM0335C1H4R8CA01#				±0.25pF	GRM0335C1H6R4CA01#
		4.9pF	±0.05pF	GRM0335C1H4R9WA01#			6.5pF	±0.05pF	GRM0335C1H6R5WA01#
			±0.1pF	GRM0335C1H4R9BA01#				±0.1pF	GRM0335C1H6R5BA01#
			±0.25pF	GRM0335C1H4R9CA01#				±0.25pF	GRM0335C1H6R5CA01#
		5.0pF	±0.05pF	GRM0335C1H5R0WA01#			6.6pF	±0.05pF	GRM0335C1H6R6WA01#
			±0.1pF	GRM0335C1H5R0BA01#				±0.1pF	GRM0335C1H6R6BA01#
			±0.25pF	GRM0335C1H5R0CA01#				±0.25pF	GRM0335C1H6R6CA01#
		5.1pF	±0.05pF	GRM0335C1H5R1WA01#			6.7pF	±0.05pF	GRM0335C1H6R7WA01#
			±0.1pF	GRM0335C1H5R1BA01#				±0.1pF	GRM0335C1H6R7BA01#
			±0.25pF	GRM0335C1H5R1CA01#				±0.25pF	GRM0335C1H6R7CA01#
		5.2pF	±0.05pF	GRM0335C1H5R2WA01#			6.8pF	±0.05pF	GRM0335C1H6R8WA01#
			±0.1pF	GRM0335C1H5R2BA01#				±0.1pF	GRM0335C1H6R8BA01#
			±0.25pF	GRM0335C1H5R2CA01#				±0.25pF	GRM0335C1H6R8CA01#
		5.3pF	±0.05pF	GRM0335C1H5R3WA01#			6.9pF	±0.05pF	GRM0335C1H6R9WA01#
			±0.1pF	GRM0335C1H5R3BA01#				±0.1pF	GRM0335C1H6R9BA01#
			±0.25pF	GRM0335C1H5R3CA01#				±0.25pF	GRM0335C1H6R9CA01#
		5.4pF	±0.05pF	GRM0335C1H5R4WA01#					
			±0.1pF	GRM0335C1H5R4BA01#					
			±0.25pF	GRM0335C1H5R4CA01#					
		5.5pF	±0.05pF	GRM0335C1H5R5WA01#					
			±0.1pF	GRM0335C1H5R5BA01#					
			±0.25pF	GRM0335C1H5R5CA01#					

Part number # indicates the package specification code.



GRM Series Temperature Compensating Type Part Number List

(→ 0.6×0.3mm)

Rated Voltage	TC Code	Cap.	Tol.	Part Number	Rated Voltage	TC Code	Cap.	Tol.	Part Number
50Vdc	COG	6.9pF	±0.25pF	GRM0335C1H6R9CA01#	50Vdc	COG	8.3pF	±0.05pF	GRM0335C1H8R3WA01#
			±0.5pF	GRM0335C1H6R9DA01#				±0.1pF	GRM0335C1H8R3BA01#
		7.0pF	±0.05pF	GRM0335C1H7R0WA01#			±0.25pF	GRM0335C1H8R3CA01#	
			±0.1pF	GRM0335C1H7R0BA01#			±0.5pF	GRM0335C1H8R3DA01#	
			±0.25pF	GRM0335C1H7R0CA01#			8.4pF	±0.05pF	GRM0335C1H8R4WA01#
			±0.5pF	GRM0335C1H7R0DA01#				±0.1pF	GRM0335C1H8R4BA01#
		7.1pF	±0.05pF	GRM0335C1H7R1WA01#				±0.25pF	GRM0335C1H8R4CA01#
			±0.1pF	GRM0335C1H7R1BA01#			±0.5pF	GRM0335C1H8R4DA01#	
			±0.25pF	GRM0335C1H7R1CA01#			8.5pF	±0.05pF	GRM0335C1H8R5WA01#
		±0.5pF	GRM0335C1H7R1DA01#	±0.1pF				GRM0335C1H8R5BA01#	
		7.2pF	±0.05pF	GRM0335C1H7R2WA01#				±0.25pF	GRM0335C1H8R5CA01#
			±0.1pF	GRM0335C1H7R2BA01#			±0.5pF	GRM0335C1H8R5DA01#	
			±0.25pF	GRM0335C1H7R2CA01#			8.6pF	±0.05pF	GRM0335C1H8R6WA01#
			±0.5pF	GRM0335C1H7R2DA01#				±0.1pF	GRM0335C1H8R6BA01#
		7.3pF	±0.05pF	GRM0335C1H7R3WA01#				±0.25pF	GRM0335C1H8R6CA01#
			±0.1pF	GRM0335C1H7R3BA01#			±0.5pF	GRM0335C1H8R6DA01#	
			±0.25pF	GRM0335C1H7R3CA01#			8.7pF	±0.05pF	GRM0335C1H8R7WA01#
			±0.5pF	GRM0335C1H7R3DA01#				±0.1pF	GRM0335C1H8R7BA01#
		7.4pF	±0.05pF	GRM0335C1H7R4WA01#				±0.25pF	GRM0335C1H8R7CA01#
			±0.1pF	GRM0335C1H7R4BA01#			±0.5pF	GRM0335C1H8R7DA01#	
			±0.25pF	GRM0335C1H7R4CA01#			8.8pF	±0.05pF	GRM0335C1H8R8WA01#
			±0.5pF	GRM0335C1H7R4DA01#				±0.1pF	GRM0335C1H8R8BA01#
		7.5pF	±0.05pF	GRM0335C1H7R5WA01#				±0.25pF	GRM0335C1H8R8CA01#
			±0.1pF	GRM0335C1H7R5BA01#			±0.5pF	GRM0335C1H8R8DA01#	
			±0.25pF	GRM0335C1H7R5CA01#			8.9pF	±0.05pF	GRM0335C1H8R9WA01#
			±0.5pF	GRM0335C1H7R5DA01#				±0.1pF	GRM0335C1H8R9BA01#
		7.6pF	±0.05pF	GRM0335C1H7R6WA01#				±0.25pF	GRM0335C1H8R9CA01#
			±0.1pF	GRM0335C1H7R6BA01#			±0.5pF	GRM0335C1H8R9DA01#	
			±0.25pF	GRM0335C1H7R6CA01#			9.0pF	±0.05pF	GRM0335C1H9R0WA01#
			±0.5pF	GRM0335C1H7R6DA01#				±0.1pF	GRM0335C1H9R0BA01#
		7.7pF	±0.05pF	GRM0335C1H7R7WA01#				±0.25pF	GRM0335C1H9R0CA01#
			±0.1pF	GRM0335C1H7R7BA01#			±0.5pF	GRM0335C1H9R0DA01#	
			±0.25pF	GRM0335C1H7R7CA01#			9.1pF	±0.05pF	GRM0335C1H9R1WA01#
			±0.5pF	GRM0335C1H7R7DA01#				±0.1pF	GRM0335C1H9R1BA01#
		7.8pF	±0.05pF	GRM0335C1H7R8WA01#				±0.25pF	GRM0335C1H9R1CA01#
			±0.1pF	GRM0335C1H7R8BA01#			±0.5pF	GRM0335C1H9R1DA01#	
			±0.25pF	GRM0335C1H7R8CA01#			9.2pF	±0.05pF	GRM0335C1H9R2WA01#
			±0.5pF	GRM0335C1H7R8DA01#				±0.1pF	GRM0335C1H9R2BA01#
		7.9pF	±0.05pF	GRM0335C1H7R9WA01#				±0.25pF	GRM0335C1H9R2CA01#
			±0.1pF	GRM0335C1H7R9BA01#			±0.5pF	GRM0335C1H9R2DA01#	
			±0.25pF	GRM0335C1H7R9CA01#			9.3pF	±0.05pF	GRM0335C1H9R3WA01#
			±0.5pF	GRM0335C1H7R9DA01#				±0.1pF	GRM0335C1H9R3BA01#
		8.0pF	±0.05pF	GRM0335C1H8R0WA01#				±0.25pF	GRM0335C1H9R3CA01#
			±0.1pF	GRM0335C1H8R0BA01#			±0.5pF	GRM0335C1H9R3DA01#	
			±0.25pF	GRM0335C1H8R0CA01#			9.4pF	±0.05pF	GRM0335C1H9R4WA01#
			±0.5pF	GRM0335C1H8R0DA01#				±0.1pF	GRM0335C1H9R4BA01#
		8.1pF	±0.05pF	GRM0335C1H8R1WA01#				±0.25pF	GRM0335C1H9R4CA01#
			±0.1pF	GRM0335C1H8R1BA01#			±0.5pF	GRM0335C1H9R4DA01#	
			±0.25pF	GRM0335C1H8R1CA01#			9.5pF	±0.05pF	GRM0335C1H9R5WA01#
			±0.5pF	GRM0335C1H8R1DA01#				±0.1pF	GRM0335C1H9R5BA01#
		8.2pF	±0.05pF	GRM0335C1H8R2WA01#				±0.25pF	GRM0335C1H9R5CA01#
			±0.1pF	GRM0335C1H8R2BA01#			±0.5pF	GRM0335C1H9R5DA01#	
±0.25pF	GRM0335C1H8R2CA01#		9.6pF	±0.05pF	GRM0335C1H9R6WA01#				
±0.5pF	GRM0335C1H8R2DA01#			±0.1pF	GRM0335C1H9R6BA01#				

- GRM
- GR3
- GRJ
- GR4
- GJM
- GQM
- GA2
- GA3 GB
- GA3 GD
- GA3 GF
- LLL
- LLA
- LLM
- LLR
- NFM
- GJ4
- ZRA
- ZRB
- KRM
- KR3
- GMA
- GMD
- ⚠Caution /Notice

Part number # indicates the package specification code.

GRM Series Temperature Compensating Type Part Number List

(→ 0.6×0.3mm)

Rated Voltage	TC Code	Cap.	Tol.	Part Number	Rated Voltage	TC Code	Cap.	Tol.	Part Number
50Vdc	COG	9.6pF	±0.25pF	GRM0335C1H9R6CA01#	50Vdc	COG	47pF	±1%	GRM0335C1H470FA01#
			±0.5pF	GRM0335C1H9R6DA01#				±2%	GRM0335C1H470GA01#
		9.7pF	±0.05pF	GRM0335C1H9R7WA01#				±5%	GRM0335C1H470JA01#
			±0.1pF	GRM0335C1H9R7BA01#			51pF	±2%	GRM0335C1H510GA01#
			±0.25pF	GRM0335C1H9R7CA01#				±5%	GRM0335C1H510JA01#
			±0.5pF	GRM0335C1H9R7DA01#			56pF	±1%	GRM0335C1H560FA01#
		9.8pF	±0.05pF	GRM0335C1H9R8WA01#				±2%	GRM0335C1H560GA01#
			±0.1pF	GRM0335C1H9R8BA01#				±5%	GRM0335C1H560JA01#
		±0.25pF	GRM0335C1H9R8CA01#	62pF			±2%	GRM0335C1H620GA01#	
		±0.5pF	GRM0335C1H9R8DA01#				±5%	GRM0335C1H620JA01#	
		9.9pF	±0.05pF	GRM0335C1H9R9WA01#			68pF	±1%	GRM0335C1H680FA01#
			±0.1pF	GRM0335C1H9R9BA01#				±2%	GRM0335C1H680GA01#
			±0.25pF	GRM0335C1H9R9CA01#				±5%	GRM0335C1H680JA01#
			±0.5pF	GRM0335C1H9R9DA01#			75pF	±2%	GRM0335C1H750GA01#
		10pF	±1%	GRM0335C1H100FA01#				±5%	GRM0335C1H750JA01#
			±2%	GRM0335C1H100GA01#			82pF	±1%	GRM0335C1H820FA01#
			±5%	GRM0335C1H100JA01#				±2%	GRM0335C1H820GA01#
		11pF	±2%	GRM0335C1H110GA01#				±5%	GRM0335C1H820JA01#
			±5%	GRM0335C1H110JA01#			91pF	±2%	GRM0335C1H910GA01#
		12pF	±1%	GRM0335C1H120FA01#				±5%	GRM0335C1H910JA01#
			±2%	GRM0335C1H120GA01#			100pF	±1%	GRM0335C1H101FA01#
			±5%	GRM0335C1H120JA01#				±2%	GRM0335C1H101GA01#
		13pF	±2%	GRM0335C1H130GA01#				±5%	GRM0335C1H101JA01#
			±5%	GRM0335C1H130JA01#			110pF	±2%	GRM0335C1H111GA01#
		15pF	±1%	GRM0335C1H150FA01#				±5%	GRM0335C1H111JA01#
			±2%	GRM0335C1H150GA01#			120pF	±1%	GRM0335C1H121FA01#
			±5%	GRM0335C1H150JA01#				±2%	GRM0335C1H121GA01#
		16pF	±2%	GRM0335C1H160GA01#				±5%	GRM0335C1H121JA01#
			±5%	GRM0335C1H160JA01#			150pF	±1%	GRM0335C1H151FA01#
		18pF	±1%	GRM0335C1H180FA01#				±2%	GRM0335C1H151GA01#
			±2%	GRM0335C1H180GA01#				±5%	GRM0335C1H151JA01#
			±5%	GRM0335C1H180JA01#			180pF	±1%	GRM0335C1H181FA01#
		20pF	±2%	GRM0335C1H200GA01#				±2%	GRM0335C1H181GA01#
			±5%	GRM0335C1H200JA01#				±5%	GRM0335C1H181JA01#
		22pF	±1%	GRM0335C1H220FA01#			220pF	±1%	GRM0335C1H221FA01#
			±2%	GRM0335C1H220GA01#				±2%	GRM0335C1H221GA01#
			±5%	GRM0335C1H220JA01#				±5%	GRM0335C1H221JA01#
		24pF	±2%	GRM0335C1H240GA01#			270pF	±2%	GRM0335C1H271GE01#
			±5%	GRM0335C1H240JA01#				±5%	GRM0335C1H271JE01#
		27pF	±1%	GRM0335C1H270FA01#			330pF	±2%	GRM0335C1H331GE01#
			±2%	GRM0335C1H270GA01#				±5%	GRM0335C1H331JE01#
			±5%	GRM0335C1H270JA01#			390pF	±2%	GRM0335C1H391GE01#
		30pF	±2%	GRM0335C1H300GA01#				±5%	GRM0335C1H391JE01#
			±5%	GRM0335C1H300JA01#			470pF	±2%	GRM0335C1H471GE01#
		33pF	±1%	GRM0335C1H330FA01#				±5%	GRM0335C1H471JE01#
			±2%	GRM0335C1H330GA01#				560pF	±2%
			±5%	GRM0335C1H330JA01#			±5%		GRM0335C1H561JE01#
		36pF	±2%	GRM0335C1H360GA01#			680pF	±2%	GRM0335C1H681GE01#
±5%	GRM0335C1H360JA01#		±5%	GRM0335C1H681JE01#					
39pF	±1%	GRM0335C1H390FA01#	820pF	±2%	GRM0335C1H821GE01#				
	±2%	GRM0335C1H390GA01#		±5%	GRM0335C1H821JE01#				
	±5%	GRM0335C1H390JA01#		1000pF	±2%	GRM0335C1H102GE01#			
43pF	±2%	GRM0335C1H430GA01#	±5%		GRM0335C1H102JE01#				
	±5%	GRM0335C1H430JA01#	CH	4.0pF	±0.05pF	GRM0332C1H4R0WA01#			

Part number # indicates the package specification code.



GRM Series Temperature Compensating Type Part Number List

(→ 0.6×0.3mm)

Rated Voltage	TC Code	Cap.	Tol.	Part Number	Rated Voltage	TC Code	Cap.	Tol.	Part Number
50Vdc	CH	4.0pF	±0.1pF	GRM0332C1H4R0BA01#	50Vdc	CH	5.6pF	±0.25pF	GRM0332C1H5R6CA01#
			±0.25pF	GRM0332C1H4R0CA01#				±0.5pF	GRM0332C1H5R6DA01#
		4.1pF	±0.05pF	GRM0332C1H4R1WA01#			5.7pF	±0.05pF	GRM0332C1H5R7WA01#
			±0.1pF	GRM0332C1H4R1BA01#				±0.1pF	GRM0332C1H5R7BA01#
			±0.25pF	GRM0332C1H4R1CA01#				±0.25pF	GRM0332C1H5R7CA01#
		4.2pF	±0.05pF	GRM0332C1H4R2WA01#			5.8pF	±0.05pF	GRM0332C1H5R8WA01#
			±0.1pF	GRM0332C1H4R2BA01#				±0.1pF	GRM0332C1H5R8BA01#
			±0.25pF	GRM0332C1H4R2CA01#				±0.25pF	GRM0332C1H5R8CA01#
		4.3pF	±0.05pF	GRM0332C1H4R3WA01#			5.9pF	±0.05pF	GRM0332C1H5R9WA01#
			±0.1pF	GRM0332C1H4R3BA01#				±0.1pF	GRM0332C1H5R9BA01#
			±0.25pF	GRM0332C1H4R3CA01#				±0.25pF	GRM0332C1H5R9CA01#
		4.4pF	±0.05pF	GRM0332C1H4R4WA01#			6.0pF	±0.05pF	GRM0332C1H6R0WA01#
			±0.1pF	GRM0332C1H4R4BA01#				±0.1pF	GRM0332C1H6R0BA01#
			±0.25pF	GRM0332C1H4R4CA01#				±0.25pF	GRM0332C1H6R0CA01#
		4.5pF	±0.05pF	GRM0332C1H4R5WA01#			6.1pF	±0.05pF	GRM0332C1H6R1WA01#
			±0.1pF	GRM0332C1H4R5BA01#				±0.1pF	GRM0332C1H6R1BA01#
			±0.25pF	GRM0332C1H4R5CA01#				±0.25pF	GRM0332C1H6R1CA01#
		4.6pF	±0.05pF	GRM0332C1H4R6WA01#			6.2pF	±0.05pF	GRM0332C1H6R2WA01#
			±0.1pF	GRM0332C1H4R6BA01#				±0.1pF	GRM0332C1H6R2BA01#
			±0.25pF	GRM0332C1H4R6CA01#				±0.25pF	GRM0332C1H6R2CA01#
		4.7pF	±0.05pF	GRM0332C1H4R7WA01#			6.3pF	±0.05pF	GRM0332C1H6R3WA01#
			±0.1pF	GRM0332C1H4R7BA01#				±0.1pF	GRM0332C1H6R3BA01#
			±0.25pF	GRM0332C1H4R7CA01#				±0.25pF	GRM0332C1H6R3CA01#
		4.8pF	±0.05pF	GRM0332C1H4R8WA01#			6.4pF	±0.05pF	GRM0332C1H6R4WA01#
			±0.1pF	GRM0332C1H4R8BA01#				±0.1pF	GRM0332C1H6R4BA01#
			±0.25pF	GRM0332C1H4R8CA01#				±0.25pF	GRM0332C1H6R4CA01#
		4.9pF	±0.05pF	GRM0332C1H4R9WA01#			6.5pF	±0.05pF	GRM0332C1H6R5WA01#
			±0.1pF	GRM0332C1H4R9BA01#				±0.1pF	GRM0332C1H6R5BA01#
			±0.25pF	GRM0332C1H4R9CA01#				±0.25pF	GRM0332C1H6R5CA01#
		5.0pF	±0.05pF	GRM0332C1H5R0WA01#			6.6pF	±0.05pF	GRM0332C1H6R6WA01#
			±0.1pF	GRM0332C1H5R0BA01#				±0.1pF	GRM0332C1H6R6BA01#
			±0.25pF	GRM0332C1H5R0CA01#				±0.25pF	GRM0332C1H6R6CA01#
		5.1pF	±0.05pF	GRM0332C1H5R1WA01#			6.7pF	±0.05pF	GRM0332C1H6R7WA01#
			±0.1pF	GRM0332C1H5R1BA01#				±0.1pF	GRM0332C1H6R7BA01#
			±0.25pF	GRM0332C1H5R1CA01#				±0.25pF	GRM0332C1H6R7CA01#
			±0.5pF	GRM0332C1H5R1DA01#				±0.5pF	GRM0332C1H6R7DA01#
		5.2pF	±0.05pF	GRM0332C1H5R2WA01#			6.8pF	±0.05pF	GRM0332C1H6R8WA01#
			±0.1pF	GRM0332C1H5R2BA01#				±0.1pF	GRM0332C1H6R8BA01#
			±0.25pF	GRM0332C1H5R2CA01#				±0.25pF	GRM0332C1H6R8CA01#
			±0.5pF	GRM0332C1H5R2DA01#				±0.5pF	GRM0332C1H6R8DA01#
		5.3pF	±0.05pF	GRM0332C1H5R3WA01#			6.9pF	±0.05pF	GRM0332C1H6R9WA01#
			±0.1pF	GRM0332C1H5R3BA01#				±0.1pF	GRM0332C1H6R9BA01#
			±0.25pF	GRM0332C1H5R3CA01#				±0.25pF	GRM0332C1H6R9CA01#
			±0.5pF	GRM0332C1H5R3DA01#				±0.5pF	GRM0332C1H6R9DA01#
		5.4pF	±0.05pF	GRM0332C1H5R4WA01#					
			±0.1pF	GRM0332C1H5R4BA01#					
			±0.25pF	GRM0332C1H5R4CA01#					
			±0.5pF	GRM0332C1H5R4DA01#					
		5.5pF	±0.05pF	GRM0332C1H5R5WA01#					
			±0.1pF	GRM0332C1H5R5BA01#					
			±0.25pF	GRM0332C1H5R5CA01#					
			±0.5pF	GRM0332C1H5R5DA01#					
		5.6pF	±0.05pF	GRM0332C1H5R6WA01#					
			±0.1pF	GRM0332C1H5R6BA01#					

- GRM
- GR3
- GRJ
- GR4
- GJM
- GQM
- GA2
- GA3 GB
- GA3 GD
- GA3 GF
- LLL
- LLA
- LLM
- LLR
- NFM
- GJ4
- ZRA
- ZRB
- KRM
- KR3
- GMA
- GMD
- ⚠Caution /Notice

Part number # indicates the package specification code.

GRM Series Temperature Compensating Type Part Number List

(→ 0.6×0.3mm)

Rated Voltage	TC Code	Cap.	Tol.	Part Number	Rated Voltage	TC Code	Cap.	Tol.	Part Number	
50Vdc	CH	7.0pF	±0.05pF	GRM0332C1H7R0WA01#	50Vdc	CH	8.3pF	±0.25pF	GRM0332C1H8R3CA01#	
			±0.1pF	GRM0332C1H7R0BA01#				±0.5pF	GRM0332C1H8R3DA01#	
			±0.25pF	GRM0332C1H7R0CA01#				8.4pF	±0.05pF	GRM0332C1H8R4WA01#
			±0.5pF	GRM0332C1H7R0DA01#					±0.1pF	GRM0332C1H8R4BA01#
		7.1pF	±0.05pF	GRM0332C1H7R1WA01#			±0.25pF		GRM0332C1H8R4CA01#	
			±0.1pF	GRM0332C1H7R1BA01#			±0.5pF		GRM0332C1H8R4DA01#	
			±0.25pF	GRM0332C1H7R1CA01#			8.5pF	±0.05pF	GRM0332C1H8R5WA01#	
			±0.5pF	GRM0332C1H7R1DA01#				±0.1pF	GRM0332C1H8R5BA01#	
		7.2pF	±0.05pF	GRM0332C1H7R2WA01#				±0.25pF	GRM0332C1H8R5CA01#	
			±0.1pF	GRM0332C1H7R2BA01#				±0.5pF	GRM0332C1H8R5DA01#	
			±0.25pF	GRM0332C1H7R2CA01#			8.6pF	±0.05pF	GRM0332C1H8R6WA01#	
			±0.5pF	GRM0332C1H7R2DA01#				±0.1pF	GRM0332C1H8R6BA01#	
		7.3pF	±0.05pF	GRM0332C1H7R3WA01#				±0.25pF	GRM0332C1H8R6CA01#	
			±0.1pF	GRM0332C1H7R3BA01#				±0.5pF	GRM0332C1H8R6DA01#	
			±0.25pF	GRM0332C1H7R3CA01#			8.7pF	±0.05pF	GRM0332C1H8R7WA01#	
			±0.5pF	GRM0332C1H7R3DA01#				±0.1pF	GRM0332C1H8R7BA01#	
		7.4pF	±0.05pF	GRM0332C1H7R4WA01#				±0.25pF	GRM0332C1H8R7CA01#	
			±0.1pF	GRM0332C1H7R4BA01#				±0.5pF	GRM0332C1H8R7DA01#	
			±0.25pF	GRM0332C1H7R4CA01#			8.8pF	±0.05pF	GRM0332C1H8R8WA01#	
			±0.5pF	GRM0332C1H7R4DA01#				±0.1pF	GRM0332C1H8R8BA01#	
		7.5pF	±0.05pF	GRM0332C1H7R5WA01#				±0.25pF	GRM0332C1H8R8CA01#	
			±0.1pF	GRM0332C1H7R5BA01#				±0.5pF	GRM0332C1H8R8DA01#	
			±0.25pF	GRM0332C1H7R5CA01#			8.9pF	±0.05pF	GRM0332C1H8R9WA01#	
			±0.5pF	GRM0332C1H7R5DA01#				±0.1pF	GRM0332C1H8R9BA01#	
		7.6pF	±0.05pF	GRM0332C1H7R6WA01#				±0.25pF	GRM0332C1H8R9CA01#	
			±0.1pF	GRM0332C1H7R6BA01#				±0.5pF	GRM0332C1H8R9DA01#	
			±0.25pF	GRM0332C1H7R6CA01#			9.0pF	±0.05pF	GRM0332C1H9R0WA01#	
			±0.5pF	GRM0332C1H7R6DA01#				±0.1pF	GRM0332C1H9R0BA01#	
		7.7pF	±0.05pF	GRM0332C1H7R7WA01#				±0.25pF	GRM0332C1H9R0CA01#	
			±0.1pF	GRM0332C1H7R7BA01#				±0.5pF	GRM0332C1H9R0DA01#	
			±0.25pF	GRM0332C1H7R7CA01#			9.1pF	±0.05pF	GRM0332C1H9R1WA01#	
			±0.5pF	GRM0332C1H7R7DA01#				±0.1pF	GRM0332C1H9R1BA01#	
		7.8pF	±0.05pF	GRM0332C1H7R8WA01#				±0.25pF	GRM0332C1H9R1CA01#	
			±0.1pF	GRM0332C1H7R8BA01#				±0.5pF	GRM0332C1H9R1DA01#	
			±0.25pF	GRM0332C1H7R8CA01#			9.2pF	±0.05pF	GRM0332C1H9R2WA01#	
			±0.5pF	GRM0332C1H7R8DA01#				±0.1pF	GRM0332C1H9R2BA01#	
		7.9pF	±0.05pF	GRM0332C1H7R9WA01#				±0.25pF	GRM0332C1H9R2CA01#	
			±0.1pF	GRM0332C1H7R9BA01#				±0.5pF	GRM0332C1H9R2DA01#	
			±0.25pF	GRM0332C1H7R9CA01#			9.3pF	±0.05pF	GRM0332C1H9R3WA01#	
			±0.5pF	GRM0332C1H7R9DA01#				±0.1pF	GRM0332C1H9R3BA01#	
		8.0pF	±0.05pF	GRM0332C1H8R0WA01#				±0.25pF	GRM0332C1H9R3CA01#	
			±0.1pF	GRM0332C1H8R0BA01#				±0.5pF	GRM0332C1H9R3DA01#	
			±0.25pF	GRM0332C1H8R0CA01#			9.4pF	±0.05pF	GRM0332C1H9R4WA01#	
			±0.5pF	GRM0332C1H8R0DA01#				±0.1pF	GRM0332C1H9R4BA01#	
		8.1pF	±0.05pF	GRM0332C1H8R1WA01#				±0.25pF	GRM0332C1H9R4CA01#	
			±0.1pF	GRM0332C1H8R1BA01#				±0.5pF	GRM0332C1H9R4DA01#	
			±0.25pF	GRM0332C1H8R1CA01#			9.5pF	±0.05pF	GRM0332C1H9R5WA01#	
			±0.5pF	GRM0332C1H8R1DA01#				±0.1pF	GRM0332C1H9R5BA01#	
		8.2pF	±0.05pF	GRM0332C1H8R2WA01#				±0.25pF	GRM0332C1H9R5CA01#	
			±0.1pF	GRM0332C1H8R2BA01#				±0.5pF	GRM0332C1H9R5DA01#	
			±0.25pF	GRM0332C1H8R2CA01#			9.6pF	±0.05pF	GRM0332C1H9R6WA01#	
			±0.5pF	GRM0332C1H8R2DA01#				±0.1pF	GRM0332C1H9R6BA01#	
		8.3pF	±0.05pF	GRM0332C1H8R3WA01#				±0.25pF	GRM0332C1H9R6CA01#	
			±0.1pF	GRM0332C1H8R3BA01#				±0.5pF	GRM0332C1H9R6DA01#	

- GRM
- GR3
- GRJ
- GR4
- GJM
- GQM
- GQZ
- GA2
- GA3
- GA3
- GA3
- GA3
- LLL
- LLA
- LLM
- LLR
- NFM
- GJ4
- ZRA
- ZRB
- KRM
- KR3
- GMA
- GMD
- △Caution / Notice

Part number # indicates the package specification code.

GRM Series Temperature Compensating Type Part Number List

(→ 0.6×0.3mm)

Rated Voltage	TC Code	Cap.	Tol.	Part Number	Rated Voltage	TC Code	Cap.	Tol.	Part Number	
50Vdc	CH	9.7pF	±0.05pF	GRM0332C1H9R7WA01#	50Vdc	CH	75pF	±2%	GRM0332C1H750GA01#	
			±0.1pF	GRM0332C1H9R7BA01#				±5%	GRM0332C1H750JA01#	
			±0.25pF	GRM0332C1H9R7CA01#				82pF	±2%	GRM0332C1H820GA01#
			±0.5pF	GRM0332C1H9R7DA01#					±5%	GRM0332C1H820JA01#
		9.8pF	±0.05pF	GRM0332C1H9R8WA01#			91pF	±2%	GRM0332C1H910GA01#	
			±0.1pF	GRM0332C1H9R8BA01#				±5%	GRM0332C1H910JA01#	
			±0.25pF	GRM0332C1H9R8CA01#			100pF	±2%	GRM0332C1H101GA01#	
			±0.5pF	GRM0332C1H9R8DA01#				±5%	GRM0332C1H101JA01#	
		9.9pF	±0.05pF	GRM0332C1H9R9WA01#			110pF	±2%	GRM0332C1H111GA01#	
			±0.1pF	GRM0332C1H9R9BA01#				±5%	GRM0332C1H111JA01#	
			±0.25pF	GRM0332C1H9R9CA01#			120pF	±2%	GRM0332C1H121GA01#	
			±0.5pF	GRM0332C1H9R9DA01#				±5%	GRM0332C1H121JA01#	
		10pF	±2%	GRM0332C1H100GA01#			150pF	±2%	GRM0332C1H151GA01#	
			±5%	GRM0332C1H100JA01#				±5%	GRM0332C1H151JA01#	
		11pF	±2%	GRM0332C1H110GA01#				180pF	±2%	GRM0332C1H181GA01#
			±5%	GRM0332C1H110JA01#			±5%		GRM0332C1H181JA01#	
		12pF	±2%	GRM0332C1H120GA01#			220pF		±2%	GRM0332C1H221GA01#
			±5%	GRM0332C1H120JA01#				±5%	GRM0332C1H221JA01#	
		13pF	±2%	GRM0332C1H130GA01#				CJ	2.1pF	±0.05pF
			±5%	GRM0332C1H130JA01#			±0.1pF			GRM0333C1H2R1BA01#
		15pF	±2%	GRM0332C1H150GA01#			±0.25pF			GRM0333C1H2R1CA01#
			±5%	GRM0332C1H150JA01#			2.2pF	±0.05pF	GRM0333C1H2R2WA01#	
		16pF	±2%	GRM0332C1H160GA01#				±0.1pF	GRM0333C1H2R2BA01#	
			±5%	GRM0332C1H160JA01#				±0.25pF	GRM0333C1H2R2CA01#	
		18pF	±2%	GRM0332C1H180GA01#			2.3pF	±0.05pF	GRM0333C1H2R3WA01#	
			±5%	GRM0332C1H180JA01#				±0.1pF	GRM0333C1H2R3BA01#	
		20pF	±2%	GRM0332C1H200GA01#				±0.25pF	GRM0333C1H2R3CA01#	
			±5%	GRM0332C1H200JA01#			2.4pF	±0.05pF	GRM0333C1H2R4WA01#	
		22pF	±2%	GRM0332C1H220GA01#				±0.1pF	GRM0333C1H2R4BA01#	
			±5%	GRM0332C1H220JA01#				±0.25pF	GRM0333C1H2R4CA01#	
		24pF	±2%	GRM0332C1H240GA01#			2.5pF	±0.05pF	GRM0333C1H2R5WA01#	
			±5%	GRM0332C1H240JA01#				±0.1pF	GRM0333C1H2R5BA01#	
		27pF	±2%	GRM0332C1H270GA01#				±0.25pF	GRM0333C1H2R5CA01#	
			±5%	GRM0332C1H270JA01#			2.6pF	±0.05pF	GRM0333C1H2R6WA01#	
		30pF	±2%	GRM0332C1H300GA01#				±0.1pF	GRM0333C1H2R6BA01#	
			±5%	GRM0332C1H300JA01#				±0.25pF	GRM0333C1H2R6CA01#	
		33pF	±2%	GRM0332C1H330GA01#			2.7pF	±0.05pF	GRM0333C1H2R7WA01#	
			±5%	GRM0332C1H330JA01#				±0.1pF	GRM0333C1H2R7BA01#	
		36pF	±2%	GRM0332C1H360GA01#				±0.25pF	GRM0333C1H2R7CA01#	
			±5%	GRM0332C1H360JA01#			2.8pF	±0.05pF	GRM0333C1H2R8WA01#	
		39pF	±2%	GRM0332C1H390GA01#				±0.1pF	GRM0333C1H2R8BA01#	
			±5%	GRM0332C1H390JA01#				±0.25pF	GRM0333C1H2R8CA01#	
		43pF	±2%	GRM0332C1H430GA01#			2.9pF	±0.05pF	GRM0333C1H2R9WA01#	
			±5%	GRM0332C1H430JA01#				±0.1pF	GRM0333C1H2R9BA01#	
		47pF	±2%	GRM0332C1H470GA01#				±0.25pF	GRM0333C1H2R9CA01#	
			±5%	GRM0332C1H470JA01#			3.0pF	±0.05pF	GRM0333C1H3R0WA01#	
		51pF	±2%	GRM0332C1H510GA01#				±0.1pF	GRM0333C1H3R0BA01#	
			±5%	GRM0332C1H510JA01#				±0.25pF	GRM0333C1H3R0CA01#	
		56pF	±2%	GRM0332C1H560GA01#			3.1pF	±0.05pF	GRM0333C1H3R1WA01#	
			±5%	GRM0332C1H560JA01#				±0.1pF	GRM0333C1H3R1BA01#	
		62pF	±2%	GRM0332C1H620GA01#				±0.25pF	GRM0333C1H3R1CA01#	
			±5%	GRM0332C1H620JA01#			3.2pF	±0.05pF	GRM0333C1H3R2WA01#	
68pF	±2%	GRM0332C1H680GA01#	±0.1pF	GRM0333C1H3R2BA01#						
	±5%	GRM0332C1H680JA01#	±0.25pF	GRM0333C1H3R2CA01#						

- GRM
- GR3
- GRJ
- GR4
- GJM
- GQM
- GA2
- GA3 GB
- GA3 GD
- GA3 GF
- LLL
- LLA
- LLM
- LLR
- NFM
- GJ4
- ZRA
- ZRB
- KRM
- KR3
- GMA
- GMD
- ⚠Caution /Notice

Part number # indicates the package specification code.

GRM Series Temperature Compensating Type Part Number List

(→ 0.6×0.3mm)

Rated Voltage	TC Code	Cap.	Tol.	Part Number	Rated Voltage	TC Code	Cap.	Tol.	Part Number		
50Vdc	CJ	3.3pF	±0.05pF	GRM0333C1H3R3WA01#	50Vdc	CK	1.5pF	±0.1pF	GRM0334C1H1R5BA01#		
			±0.1pF	GRM0333C1H3R3BA01#				±0.25pF	GRM0334C1H1R5CA01#		
			±0.25pF	GRM0333C1H3R3CA01#				1.6pF	±0.05pF	GRM0334C1H1R6WA01#	
		3.4pF	±0.05pF	GRM0333C1H3R4WA01#			±0.1pF		GRM0334C1H1R6BA01#		
			±0.1pF	GRM0333C1H3R4BA01#			±0.25pF		GRM0334C1H1R6CA01#		
			±0.25pF	GRM0333C1H3R4CA01#			1.7pF	±0.05pF	GRM0334C1H1R7WA01#		
		3.5pF	±0.05pF	GRM0333C1H3R5WA01#				±0.1pF	GRM0334C1H1R7BA01#		
			±0.1pF	GRM0333C1H3R5BA01#				±0.25pF	GRM0334C1H1R7CA01#		
			±0.25pF	GRM0333C1H3R5CA01#			1.8pF	±0.05pF	GRM0334C1H1R8WA01#		
		3.6pF	±0.05pF	GRM0333C1H3R6WA01#				±0.1pF	GRM0334C1H1R8BA01#		
			±0.1pF	GRM0333C1H3R6BA01#				±0.25pF	GRM0334C1H1R8CA01#		
			±0.25pF	GRM0333C1H3R6CA01#			1.9pF	±0.05pF	GRM0334C1H1R9WA01#		
		3.7pF	±0.05pF	GRM0333C1H3R7WA01#				±0.1pF	GRM0334C1H1R9BA01#		
			±0.1pF	GRM0333C1H3R7BA01#				±0.25pF	GRM0334C1H1R9CA01#		
			±0.25pF	GRM0333C1H3R7CA01#			2.0pF	±0.05pF	GRM0334C1H2R0WA01#		
		3.8pF	±0.05pF	GRM0333C1H3R8WA01#				±0.1pF	GRM0334C1H2R0BA01#		
			±0.1pF	GRM0333C1H3R8BA01#				±0.25pF	GRM0334C1H2R0CA01#		
			±0.25pF	GRM0333C1H3R8CA01#			25Vdc	COG	0.10pF	±0.05pF	GRM0335C1ER10WA01#
		3.9pF	±0.05pF	GRM0333C1H3R9WA01#						±0.1pF	GRM0335C1ER10BA01#
			±0.1pF	GRM0333C1H3R9BA01#						±0.25pF	GRM0335C1ER10CA01#
			±0.25pF	GRM0333C1H3R9CA01#			0.20pF		±0.05pF	GRM0335C1ER20WA01#	
		0.10pF	±0.05pF	GRM0334C1HR10WA01#					±0.1pF	GRM0335C1ER20BA01#	
			±0.1pF	GRM0334C1HR10BA01#					±0.25pF	GRM0335C1ER20CA01#	
			0.20pF	±0.05pF			GRM0334C1HR20WA01#		0.30pF	±0.05pF	GRM0335C1ER30WA01#
		±0.1pF		GRM0334C1HR20BA01#			±0.1pF			GRM0335C1ER30BA01#	
		±0.25pF		GRM0334C1HR20CA01#			0.40pF			±0.05pF	GRM0335C1ER40WA01#
		0.30pF	±0.05pF	GRM0334C1HR30WA01#					±0.1pF	GRM0335C1ER40BA01#	
			±0.1pF	GRM0334C1HR30BA01#					0.50pF	±0.05pF	GRM0335C1ER50WA01#
			0.40pF	±0.05pF			GRM0334C1HR40WA01#			±0.1pF	GRM0335C1ER50BA01#
		±0.1pF		GRM0334C1HR40BA01#			0.60pF			±0.05pF	GRM0335C1ER60WA01#
		0.50pF		±0.05pF					GRM0334C1HR50WA01#	±0.1pF	GRM0335C1ER60BA01#
			±0.1pF	GRM0334C1HR50BA01#					0.70pF	±0.05pF	GRM0335C1ER70WA01#
			0.60pF	±0.05pF			GRM0334C1HR60WA01#			±0.1pF	GRM0335C1ER70BA01#
		±0.1pF		GRM0334C1HR60BA01#			0.80pF			±0.05pF	GRM0335C1ER80WA01#
		0.70pF		±0.05pF					GRM0334C1HR70WA01#	±0.1pF	GRM0335C1ER80BA01#
			±0.1pF	GRM0334C1HR70BA01#					0.90pF	±0.05pF	GRM0335C1ER90WA01#
0.80pF	±0.05pF		GRM0334C1HR80WA01#	±0.1pF	GRM0335C1ER90BA01#						
	±0.1pF	GRM0334C1HR80BA01#	1.0pF	±0.25pF	GRM0335C1E1R0CA01#						
	0.90pF	±0.05pF		GRM0334C1HR90WA01#	±0.05pF	GRM0335C1E1R1WA01#					
±0.1pF		GRM0334C1HR90BA01#		±0.1pF	GRM0335C1E1R1BA01#						
±0.25pF		GRM0334C1H1R0CA01#	±0.25pF	GRM0335C1E1R1CA01#							
1.0pF	±0.05pF	GRM0334C1H1R0WA01#	1.1pF	±0.05pF	GRM0335C1E1R2WA01#						
	±0.1pF	GRM0334C1H1R0BA01#		±0.1pF	GRM0335C1E1R2BA01#						
	±0.25pF	GRM0334C1H1R0CA01#		±0.25pF	GRM0335C1E1R2CA01#						
1.1pF	±0.05pF	GRM0334C1H1R1WA01#	1.2pF	±0.05pF	GRM0335C1E1R3WA01#						
	±0.1pF	GRM0334C1H1R1BA01#		±0.1pF	GRM0335C1E1R3BA01#						
	±0.25pF	GRM0334C1H1R1CA01#		±0.25pF	GRM0335C1E1R3CA01#						
1.2pF	±0.05pF	GRM0334C1H1R2WA01#	1.3pF	±0.05pF	GRM0335C1E1R4WA01#						
	±0.1pF	GRM0334C1H1R2BA01#		±0.1pF	GRM0335C1E1R4BA01#						
	±0.25pF	GRM0334C1H1R2CA01#		±0.25pF	GRM0335C1E1R4CA01#						
1.3pF	±0.05pF	GRM0334C1H1R3WA01#	1.4pF	±0.05pF	GRM0335C1E1R5WA01#						
	±0.1pF	GRM0334C1H1R3BA01#		±0.1pF	GRM0335C1E1R5BA01#						
	±0.25pF	GRM0334C1H1R3CA01#		±0.25pF	GRM0335C1E1R5CA01#						
1.4pF	±0.05pF	GRM0334C1H1R4WA01#	1.5pF	±0.05pF	GRM0335C1E1R6WA01#						
	±0.1pF	GRM0334C1H1R4BA01#		±0.1pF	GRM0335C1E1R6BA01#						
	±0.25pF	GRM0334C1H1R4CA01#		±0.25pF	GRM0335C1E1R6CA01#						
1.5pF	±0.05pF	GRM0334C1H1R5WA01#	1.6pF	±0.05pF	GRM0335C1E1R7WA01#						
	±0.1pF	GRM0334C1H1R5BA01#		±0.1pF	GRM0335C1E1R7BA01#						
	±0.25pF	GRM0334C1H1R5CA01#		±0.25pF	GRM0335C1E1R7CA01#						

Part number # indicates the package specification code.

GRM
 GR3
 GRJ
 GR4
 GJM
 GQM
 GA2
 GA3 GB
 GA3 GD
 GA3 GF
 LLL
 LLA
 LLM
 LLR
 NFM
 GJ4
 ZRA
 ZRB
 KRM
 KR3
 GMA
 GMD
 ⚠Caution /Notice

GRM Series Temperature Compensating Type Part Number List

(→ 0.6×0.3mm)

Rated Voltage	TC Code	Cap.	Tol.	Part Number	Rated Voltage	TC Code	Cap.	Tol.	Part Number		
25Vdc	COG	1.6pF	±0.25pF	GRM0335C1E1R6CA01#	25Vdc	COG	3.4pF	±0.25pF	GRM0335C1E3R4CA01#		
			1.7pF	±0.05pF				GRM0335C1E1R7WA01#	3.5pF	±0.05pF	GRM0335C1E3R5WA01#
				±0.1pF				GRM0335C1E1R7BA01#		±0.1pF	GRM0335C1E3R5BA01#
		±0.25pF		GRM0335C1E1R7CA01#			±0.25pF	GRM0335C1E3R5CA01#			
		1.8pF	±0.05pF	GRM0335C1E1R8WA01#			3.6pF	±0.05pF	GRM0335C1E3R6WA01#		
			±0.1pF	GRM0335C1E1R8BA01#				±0.1pF	GRM0335C1E3R6BA01#		
			±0.25pF	GRM0335C1E1R8CA01#				±0.25pF	GRM0335C1E3R6CA01#		
		1.9pF	±0.05pF	GRM0335C1E1R9WA01#			3.7pF	±0.05pF	GRM0335C1E3R7WA01#		
			±0.1pF	GRM0335C1E1R9BA01#				±0.1pF	GRM0335C1E3R7BA01#		
			±0.25pF	GRM0335C1E1R9CA01#				±0.25pF	GRM0335C1E3R7CA01#		
		2.0pF	±0.05pF	GRM0335C1E2R0WA01#			3.8pF	±0.05pF	GRM0335C1E3R8WA01#		
			±0.1pF	GRM0335C1E2R0BA01#				±0.1pF	GRM0335C1E3R8BA01#		
			±0.25pF	GRM0335C1E2R0CA01#				±0.25pF	GRM0335C1E3R8CA01#		
		2.1pF	±0.05pF	GRM0335C1E2R1WA01#			3.9pF	±0.05pF	GRM0335C1E3R9WA01#		
			±0.1pF	GRM0335C1E2R1BA01#				±0.1pF	GRM0335C1E3R9BA01#		
			±0.25pF	GRM0335C1E2R1CA01#				±0.25pF	GRM0335C1E3R9CA01#		
		2.2pF	±0.05pF	GRM0335C1E2R2WA01#			4.0pF	±0.05pF	GRM0335C1E4R0WA01#		
			±0.1pF	GRM0335C1E2R2BA01#				±0.1pF	GRM0335C1E4R0BA01#		
			±0.25pF	GRM0335C1E2R2CA01#				±0.25pF	GRM0335C1E4R0CA01#		
		2.3pF	±0.05pF	GRM0335C1E2R3WA01#			4.1pF	±0.05pF	GRM0335C1E4R1WA01#		
			±0.1pF	GRM0335C1E2R3BA01#				±0.1pF	GRM0335C1E4R1BA01#		
			±0.25pF	GRM0335C1E2R3CA01#				±0.25pF	GRM0335C1E4R1CA01#		
		2.4pF	±0.05pF	GRM0335C1E2R4WA01#			4.2pF	±0.05pF	GRM0335C1E4R2WA01#		
			±0.1pF	GRM0335C1E2R4BA01#				±0.1pF	GRM0335C1E4R2BA01#		
			±0.25pF	GRM0335C1E2R4CA01#				±0.25pF	GRM0335C1E4R2CA01#		
		2.5pF	±0.05pF	GRM0335C1E2R5WA01#			4.3pF	±0.05pF	GRM0335C1E4R3WA01#		
			±0.1pF	GRM0335C1E2R5BA01#				±0.1pF	GRM0335C1E4R3BA01#		
			±0.25pF	GRM0335C1E2R5CA01#				±0.25pF	GRM0335C1E4R3CA01#		
		2.6pF	±0.05pF	GRM0335C1E2R6WA01#			4.4pF	±0.05pF	GRM0335C1E4R4WA01#		
			±0.1pF	GRM0335C1E2R6BA01#				±0.1pF	GRM0335C1E4R4BA01#		
			±0.25pF	GRM0335C1E2R6CA01#				±0.25pF	GRM0335C1E4R4CA01#		
		2.7pF	±0.05pF	GRM0335C1E2R7WA01#			4.5pF	±0.05pF	GRM0335C1E4R5WA01#		
			±0.1pF	GRM0335C1E2R7BA01#				±0.1pF	GRM0335C1E4R5BA01#		
			±0.25pF	GRM0335C1E2R7CA01#				±0.25pF	GRM0335C1E4R5CA01#		
		2.8pF	±0.05pF	GRM0335C1E2R8WA01#			4.6pF	±0.05pF	GRM0335C1E4R6WA01#		
			±0.1pF	GRM0335C1E2R8BA01#				±0.1pF	GRM0335C1E4R6BA01#		
			±0.25pF	GRM0335C1E2R8CA01#				±0.25pF	GRM0335C1E4R6CA01#		
		2.9pF	±0.05pF	GRM0335C1E2R9WA01#			4.7pF	±0.05pF	GRM0335C1E4R7WA01#		
			±0.1pF	GRM0335C1E2R9BA01#				±0.1pF	GRM0335C1E4R7BA01#		
			±0.25pF	GRM0335C1E2R9CA01#				±0.25pF	GRM0335C1E4R7CA01#		
		3.0pF	±0.05pF	GRM0335C1E3R0WA01#			4.8pF	±0.05pF	GRM0335C1E4R8WA01#		
			±0.1pF	GRM0335C1E3R0BA01#				±0.1pF	GRM0335C1E4R8BA01#		
			±0.25pF	GRM0335C1E3R0CA01#				±0.25pF	GRM0335C1E4R8CA01#		
		3.1pF	±0.05pF	GRM0335C1E3R1WA01#			4.9pF	±0.05pF	GRM0335C1E4R9WA01#		
			±0.1pF	GRM0335C1E3R1BA01#				±0.1pF	GRM0335C1E4R9BA01#		
			±0.25pF	GRM0335C1E3R1CA01#				±0.25pF	GRM0335C1E4R9CA01#		
		3.2pF	±0.05pF	GRM0335C1E3R2WA01#			5.0pF	±0.05pF	GRM0335C1E5R0WA01#		
			±0.1pF	GRM0335C1E3R2BA01#				±0.1pF	GRM0335C1E5R0BA01#		
			±0.25pF	GRM0335C1E3R2CA01#				±0.25pF	GRM0335C1E5R0CA01#		
		3.3pF	±0.05pF	GRM0335C1E3R3WA01#			5.1pF	±0.05pF	GRM0335C1E5R1WA01#		
			±0.1pF	GRM0335C1E3R3BA01#				±0.1pF	GRM0335C1E5R1BA01#		
			±0.25pF	GRM0335C1E3R3CA01#				±0.25pF	GRM0335C1E5R1CA01#		
		3.4pF	±0.05pF	GRM0335C1E3R4WA01#			5.2pF	±0.5pF	GRM0335C1E5R1DA01#		
			±0.1pF	GRM0335C1E3R4BA01#				±0.05pF	GRM0335C1E5R2WA01#		

Part number # indicates the package specification code.

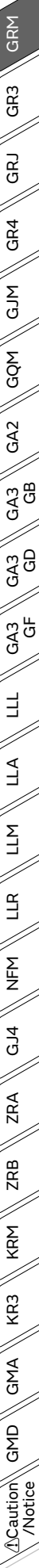

GRM Series Temperature Compensating Type Part Number List

(→ 0.6×0.3mm)

Rated Voltage	TC Code	Cap.	Tol.	Part Number	Rated Voltage	TC Code	Cap.	Tol.	Part Number	
25Vdc	COG	5.2pF	±0.1pF	GRM0335C1E5R2BA01#	25Vdc	COG	6.5pF	±0.5pF	GRM0335C1E6R5DA01#	
			±0.25pF	GRM0335C1E5R2CA01#				6.6pF	±0.05pF	GRM0335C1E6R6WA01#
			±0.5pF	GRM0335C1E5R2DA01#					±0.1pF	GRM0335C1E6R6BA01#
		5.3pF	±0.05pF	GRM0335C1E5R3WA01#			±0.25pF		GRM0335C1E6R6CA01#	
			±0.1pF	GRM0335C1E5R3BA01#			±0.5pF	GRM0335C1E6R6DA01#		
			±0.25pF	GRM0335C1E5R3CA01#			6.7pF	±0.05pF	GRM0335C1E6R7WA01#	
		±0.5pF	GRM0335C1E5R3DA01#	±0.1pF				GRM0335C1E6R7BA01#		
		5.4pF	±0.05pF	GRM0335C1E5R4WA01#				±0.25pF	GRM0335C1E6R7CA01#	
			±0.1pF	GRM0335C1E5R4BA01#			±0.5pF	GRM0335C1E6R7DA01#		
			±0.25pF	GRM0335C1E5R4CA01#			6.8pF	±0.05pF	GRM0335C1E6R8WA01#	
		±0.5pF	GRM0335C1E5R4DA01#	±0.1pF				GRM0335C1E6R8BA01#		
		5.5pF	±0.05pF	GRM0335C1E5R5WA01#				±0.25pF	GRM0335C1E6R8CA01#	
			±0.1pF	GRM0335C1E5R5BA01#			±0.5pF	GRM0335C1E6R8DA01#		
			±0.25pF	GRM0335C1E5R5CA01#			6.9pF	±0.05pF	GRM0335C1E6R9WA01#	
		±0.5pF	GRM0335C1E5R5DA01#	±0.1pF				GRM0335C1E6R9BA01#		
		5.6pF	±0.05pF	GRM0335C1E5R6WA01#				±0.25pF	GRM0335C1E6R9CA01#	
			±0.1pF	GRM0335C1E5R6BA01#			±0.5pF	GRM0335C1E6R9DA01#		
			±0.25pF	GRM0335C1E5R6CA01#			7.0pF	±0.05pF	GRM0335C1E7R0WA01#	
		±0.5pF	GRM0335C1E5R6DA01#	±0.1pF				GRM0335C1E7R0BA01#		
		5.7pF	±0.05pF	GRM0335C1E5R7WA01#				±0.25pF	GRM0335C1E7R0CA01#	
			±0.1pF	GRM0335C1E5R7BA01#			±0.5pF	GRM0335C1E7R0DA01#		
			±0.25pF	GRM0335C1E5R7CA01#			7.1pF	±0.05pF	GRM0335C1E7R1WA01#	
		±0.5pF	GRM0335C1E5R7DA01#	±0.1pF				GRM0335C1E7R1BA01#		
		5.8pF	±0.05pF	GRM0335C1E5R8WA01#				±0.25pF	GRM0335C1E7R1CA01#	
			±0.1pF	GRM0335C1E5R8BA01#			±0.5pF	GRM0335C1E7R1DA01#		
			±0.25pF	GRM0335C1E5R8CA01#			7.2pF	±0.05pF	GRM0335C1E7R2WA01#	
		±0.5pF	GRM0335C1E5R8DA01#	±0.1pF				GRM0335C1E7R2BA01#		
		5.9pF	±0.05pF	GRM0335C1E5R9WA01#				±0.25pF	GRM0335C1E7R2CA01#	
			±0.1pF	GRM0335C1E5R9BA01#			±0.5pF	GRM0335C1E7R2DA01#		
			±0.25pF	GRM0335C1E5R9CA01#			7.3pF	±0.05pF	GRM0335C1E7R3WA01#	
		±0.5pF	GRM0335C1E5R9DA01#	±0.1pF				GRM0335C1E7R3BA01#		
		6.0pF	±0.05pF	GRM0335C1E6R0WA01#				±0.25pF	GRM0335C1E7R3CA01#	
			±0.1pF	GRM0335C1E6R0BA01#			±0.5pF	GRM0335C1E7R3DA01#		
			±0.25pF	GRM0335C1E6R0CA01#			7.4pF	±0.05pF	GRM0335C1E7R4WA01#	
		±0.5pF	GRM0335C1E6R0DA01#	±0.1pF				GRM0335C1E7R4BA01#		
		6.1pF	±0.05pF	GRM0335C1E6R1WA01#				±0.25pF	GRM0335C1E7R4CA01#	
			±0.1pF	GRM0335C1E6R1BA01#			±0.5pF	GRM0335C1E7R4DA01#		
			±0.25pF	GRM0335C1E6R1CA01#			7.5pF	±0.05pF	GRM0335C1E7R5WA01#	
		±0.5pF	GRM0335C1E6R1DA01#	±0.1pF				GRM0335C1E7R5BA01#		
		6.2pF	±0.05pF	GRM0335C1E6R2WA01#				±0.25pF	GRM0335C1E7R5CA01#	
			±0.1pF	GRM0335C1E6R2BA01#			±0.5pF	GRM0335C1E7R5DA01#		
			±0.25pF	GRM0335C1E6R2CA01#			7.6pF	±0.05pF	GRM0335C1E7R6WA01#	
		±0.5pF	GRM0335C1E6R2DA01#	±0.1pF				GRM0335C1E7R6BA01#		
		6.3pF	±0.05pF	GRM0335C1E6R3WA01#				±0.25pF	GRM0335C1E7R6CA01#	
			±0.1pF	GRM0335C1E6R3BA01#			±0.5pF	GRM0335C1E7R6DA01#		
			±0.25pF	GRM0335C1E6R3CA01#			7.7pF	±0.05pF	GRM0335C1E7R7WA01#	
		±0.5pF	GRM0335C1E6R3DA01#	±0.1pF				GRM0335C1E7R7BA01#		
		6.4pF	±0.05pF	GRM0335C1E6R4WA01#				±0.25pF	GRM0335C1E7R7CA01#	
			±0.1pF	GRM0335C1E6R4BA01#			±0.5pF	GRM0335C1E7R7DA01#		
			±0.25pF	GRM0335C1E6R4CA01#			7.8pF	±0.05pF	GRM0335C1E7R8WA01#	
		±0.5pF	GRM0335C1E6R4DA01#	±0.1pF				GRM0335C1E7R8BA01#		
		6.5pF	±0.05pF	GRM0335C1E6R5WA01#				±0.25pF	GRM0335C1E7R8CA01#	
			±0.1pF	GRM0335C1E6R5BA01#			±0.5pF	GRM0335C1E7R8DA01#		
			±0.25pF	GRM0335C1E6R5CA01#			7.9pF	±0.05pF	GRM0335C1E7R9WA01#	

Part number # indicates the package specification code.

GRM
 GR3
 GRJ
 GR4
 GJM
 GQM
 GA2
 GA3 GB
 GA3 GD
 GA3 GF
 LLL
 LLA
 LLM
 LLR
 NFM
 GJ4
 ZRA
 ZRB
 KRM
 KR3
 GMA
 GMD
 ⚠Caution /Notice

GRM Series Temperature Compensating Type Part Number List

(→ 0.6×0.3mm)

Rated Voltage	TC Code	Cap.	Tol.	Part Number	Rated Voltage	TC Code	Cap.	Tol.	Part Number	
25Vdc	COG	7.9pF	±0.1pF	GRM0335C1E7R9BA01#	25Vdc	COG	9.2pF	±0.5pF	GRM0335C1E9R2DA01#	
			±0.25pF	GRM0335C1E7R9CA01#				9.3pF	±0.05pF	GRM0335C1E9R3WA01#
			±0.5pF	GRM0335C1E7R9DA01#					±0.1pF	GRM0335C1E9R3BA01#
		8.0pF	±0.05pF	GRM0335C1E8R0WA01#			±0.25pF		GRM0335C1E9R3CA01#	
			±0.1pF	GRM0335C1E8R0BA01#			±0.5pF	GRM0335C1E9R3DA01#		
			±0.25pF	GRM0335C1E8R0CA01#			9.4pF	±0.05pF	GRM0335C1E9R4WA01#	
		±0.5pF	GRM0335C1E8R0DA01#	±0.1pF				GRM0335C1E9R4BA01#		
		8.1pF	±0.05pF	GRM0335C1E8R1WA01#				±0.25pF	GRM0335C1E9R4CA01#	
			±0.1pF	GRM0335C1E8R1BA01#			±0.5pF	GRM0335C1E9R4DA01#		
			±0.25pF	GRM0335C1E8R1CA01#			9.5pF	±0.05pF	GRM0335C1E9R5WA01#	
		±0.5pF	GRM0335C1E8R1DA01#	±0.1pF				GRM0335C1E9R5BA01#		
		8.2pF	±0.05pF	GRM0335C1E8R2WA01#				±0.25pF	GRM0335C1E9R5CA01#	
			±0.1pF	GRM0335C1E8R2BA01#			±0.5pF	GRM0335C1E9R5DA01#		
			±0.25pF	GRM0335C1E8R2CA01#			9.6pF	±0.05pF	GRM0335C1E9R6WA01#	
		±0.5pF	GRM0335C1E8R2DA01#	±0.1pF				GRM0335C1E9R6BA01#		
		8.3pF	±0.05pF	GRM0335C1E8R3WA01#				±0.25pF	GRM0335C1E9R6CA01#	
			±0.1pF	GRM0335C1E8R3BA01#			±0.5pF	GRM0335C1E9R6DA01#		
			±0.25pF	GRM0335C1E8R3CA01#			9.7pF	±0.05pF	GRM0335C1E9R7WA01#	
		±0.5pF	GRM0335C1E8R3DA01#	±0.1pF				GRM0335C1E9R7BA01#		
		8.4pF	±0.05pF	GRM0335C1E8R4WA01#				±0.25pF	GRM0335C1E9R7CA01#	
			±0.1pF	GRM0335C1E8R4BA01#			±0.5pF	GRM0335C1E9R7DA01#		
			±0.25pF	GRM0335C1E8R4CA01#			9.8pF	±0.05pF	GRM0335C1E9R8WA01#	
		±0.5pF	GRM0335C1E8R4DA01#	±0.1pF				GRM0335C1E9R8BA01#		
		8.5pF	±0.05pF	GRM0335C1E8R5WA01#				±0.25pF	GRM0335C1E9R8CA01#	
			±0.1pF	GRM0335C1E8R5BA01#			±0.5pF	GRM0335C1E9R8DA01#		
			±0.25pF	GRM0335C1E8R5CA01#			9.9pF	±0.05pF	GRM0335C1E9R9WA01#	
		±0.5pF	GRM0335C1E8R5DA01#	±0.1pF				GRM0335C1E9R9BA01#		
		8.6pF	±0.05pF	GRM0335C1E8R6WA01#				±0.25pF	GRM0335C1E9R9CA01#	
			±0.1pF	GRM0335C1E8R6BA01#			±0.5pF	GRM0335C1E9R9DA01#		
			±0.25pF	GRM0335C1E8R6CA01#			10pF	±2%	GRM0335C1E100GA01#	
		±0.5pF	GRM0335C1E8R6DA01#	±5%				GRM0335C1E100JA01#		
		8.7pF	±0.05pF	GRM0335C1E8R7WA01#				11pF	±2%	GRM0335C1E110GA01#
			±0.1pF	GRM0335C1E8R7BA01#			±5%		GRM0335C1E110JA01#	
			±0.25pF	GRM0335C1E8R7CA01#			12pF		±2%	GRM0335C1E120GA01#
		±0.5pF	GRM0335C1E8R7DA01#	±5%				GRM0335C1E120JA01#		
		8.8pF	±0.05pF	GRM0335C1E8R8WA01#				13pF	±2%	GRM0335C1E130GA01#
			±0.1pF	GRM0335C1E8R8BA01#			±5%		GRM0335C1E130JA01#	
			±0.25pF	GRM0335C1E8R8CA01#			15pF		±2%	GRM0335C1E150GA01#
		±0.5pF	GRM0335C1E8R8DA01#	±5%				GRM0335C1E150JA01#		
		8.9pF	±0.05pF	GRM0335C1E8R9WA01#				16pF	±2%	GRM0335C1E160GA01#
			±0.1pF	GRM0335C1E8R9BA01#			±5%		GRM0335C1E160JA01#	
			±0.25pF	GRM0335C1E8R9CA01#			18pF		±1%	GRM0335C1E180FA01#
		±0.5pF	GRM0335C1E8R9DA01#	±2%				GRM0335C1E180GA01#		
		9.0pF	±0.05pF	GRM0335C1E9R0WA01#				±5%	GRM0335C1E180JA01#	
			±0.1pF	GRM0335C1E9R0BA01#			20pF	±2%	GRM0335C1E200GA01#	
			±0.25pF	GRM0335C1E9R0CA01#				±5%	GRM0335C1E200JA01#	
		±0.5pF	GRM0335C1E9R0DA01#	22pF				±1%	GRM0335C1E220FA01#	
		9.1pF	±0.05pF				GRM0335C1E9R1WA01#	±2%	GRM0335C1E220GA01#	
			±0.1pF				GRM0335C1E9R1BA01#	±5%	GRM0335C1E220JA01#	
			±0.25pF	GRM0335C1E9R1CA01#			24pF	±2%	GRM0335C1E240GA01#	
		±0.5pF	GRM0335C1E9R1DA01#	±5%				GRM0335C1E240JA01#		
		9.2pF	±0.05pF	GRM0335C1E9R2WA01#				27pF	±1%	GRM0335C1E270FA01#
			±0.1pF	GRM0335C1E9R2BA01#			±2%		GRM0335C1E270GA01#	
			±0.25pF	GRM0335C1E9R2CA01#			±5%		GRM0335C1E270JA01#	

Part number # indicates the package specification code.

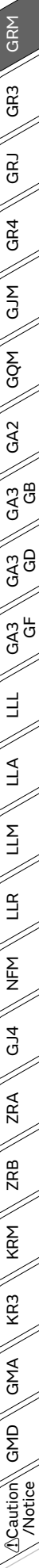

GRM Series Temperature Compensating Type Part Number List

(→ 0.6×0.3mm)

Rated Voltage	TC Code	Cap.	Tol.	Part Number	Rated Voltage	TC Code	Cap.	Tol.	Part Number	
25Vdc	COG	30pF	±2%	GRM0335C1E300GA01#	25Vdc	COG	560pF	±5%	GRM0335C1E561JA01#	
			±5%	GRM0335C1E300JA01#				680pF	±1%	GRM0335C1E681FA01#
		33pF	±1%	GRM0335C1E330FA01#			±2%		GRM0335C1E681GA01#	
			±2%	GRM0335C1E330GA01#			±5%	GRM0335C1E681JA01#		
			36pF	±2%			GRM0335C1E360GA01#	820pF	±1%	GRM0335C1E821FA01#
				±5%			GRM0335C1E360JA01#		±2%	GRM0335C1E821GA01#
		39pF		±1%			GRM0335C1E390FA01#		±5%	GRM0335C1E821JA01#
			±2%	GRM0335C1E390GA01#			910pF	±2%	GRM0335C1E911GA01#	
			±5%	GRM0335C1E390JA01#				±5%	GRM0335C1E911JA01#	
		43pF	±2%	GRM0335C1E430GA01#			1000pF	±1%	GRM0335C1E102FA01#	
			±5%	GRM0335C1E430JA01#				±2%	GRM0335C1E102GA01#	
			47pF	±1%				GRM0335C1E470FA01#	CH	4.0pF
		±2%		GRM0335C1E470GA01#			±0.1pF	GRM0332C1E4R0BA01#		
		±5%		GRM0335C1E470JA01#			±0.25pF	GRM0332C1E4R0CA01#		
		51pF	±2%	GRM0335C1E510GA01#			4.1pF	±0.05pF	GRM0332C1E4R1WA01#	
			±5%	GRM0335C1E510JA01#				±0.1pF	GRM0332C1E4R1BA01#	
			56pF	±1%				GRM0335C1E560FA01#	±0.25pF	GRM0332C1E4R1CA01#
		±2%		GRM0335C1E560GA01#			4.2pF	±0.05pF	GRM0332C1E4R2WA01#	
		±5%		GRM0335C1E560JA01#				±0.1pF	GRM0332C1E4R2BA01#	
		62pF	±2%	GRM0335C1E620GA01#				±0.25pF	GRM0332C1E4R2CA01#	
			±5%	GRM0335C1E620JA01#			4.3pF	±0.05pF	GRM0332C1E4R3WA01#	
			68pF	±1%				GRM0335C1E680FA01#	±0.1pF	GRM0332C1E4R3BA01#
		±2%		GRM0335C1E680GA01#				±0.25pF	GRM0332C1E4R3CA01#	
		±5%		GRM0335C1E680JA01#			4.4pF	±0.05pF	GRM0332C1E4R4WA01#	
		75pF	±2%	GRM0335C1E750GA01#				±0.1pF	GRM0332C1E4R4BA01#	
			±5%	GRM0335C1E750JA01#				±0.25pF	GRM0332C1E4R4CA01#	
			82pF	±1%			GRM0335C1E820FA01#	4.5pF	±0.05pF	GRM0332C1E4R5WA01#
		±2%		GRM0335C1E820GA01#			±0.1pF		GRM0332C1E4R5BA01#	
		±5%		GRM0335C1E820JA01#			±0.25pF		GRM0332C1E4R5CA01#	
		91pF	±2%	GRM0335C1E910GA01#			4.6pF	±0.05pF	GRM0332C1E4R6WA01#	
			±5%	GRM0335C1E910JA01#				±0.1pF	GRM0332C1E4R6BA01#	
			100pF	±1%				GRM0335C1E101FA01#	±0.25pF	GRM0332C1E4R6CA01#
		±2%		GRM0335C1E101GA01#			4.7pF	±0.05pF	GRM0332C1E4R7WA01#	
		±5%		GRM0335C1E101JA01#				±0.1pF	GRM0332C1E4R7BA01#	
		110pF	±2%	GRM0335C1E111GA01#				±0.25pF	GRM0332C1E4R7CA01#	
			±5%	GRM0335C1E111JA01#			4.8pF	±0.05pF	GRM0332C1E4R8WA01#	
			150pF	±5%				GRM0335C1E151JA01#	±0.1pF	GRM0332C1E4R8BA01#
		180pF		±5%				GRM0335C1E181JA01#	±0.25pF	GRM0332C1E4R8CA01#
				220pF			±5%	GRM0335C1E221JA01#	4.9pF	±0.05pF
			270pF				±1%	GRM0335C1E271FA01#		±0.1pF
		±2%					GRM0335C1E271GA01#	±0.25pF		GRM0332C1E4R9CA01#
		±5%		GRM0335C1E271JA01#			5.0pF	±0.05pF	GRM0332C1E5R0WA01#	
		330pF	±1%	GRM0335C1E331FA01#				±0.1pF	GRM0332C1E5R0BA01#	
			±2%	GRM0335C1E331GA01#				±0.25pF	GRM0332C1E5R0CA01#	
			±5%	GRM0335C1E331JA01#			5.1pF	±0.05pF	GRM0332C1E5R1WA01#	
		390pF	±1%	GRM0335C1E391FA01#				±0.1pF	GRM0332C1E5R1BA01#	
			±2%	GRM0335C1E391GA01#				±0.25pF	GRM0332C1E5R1CA01#	
			±5%	GRM0335C1E391JA01#			5.2pF	±0.5pF	GRM0332C1E5R1DA01#	
		470pF	±1%	GRM0335C1E471FA01#				±0.05pF	GRM0332C1E5R2WA01#	
			±2%	GRM0335C1E471GA01#				±0.1pF	GRM0332C1E5R2BA01#	
±5%	GRM0335C1E471JA01#		±0.25pF	GRM0332C1E5R2CA01#						
560pF	±1%	GRM0335C1E561FA01#	5.3pF	±0.5pF	GRM0332C1E5R2DA01#					
	±2%	GRM0335C1E561GA01#		±0.05pF	GRM0332C1E5R3WA01#					

Part number # indicates the package specification code.

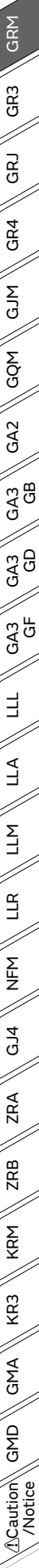

GRM Series Temperature Compensating Type Part Number List

(→ 0.6×0.3mm)

Rated Voltage	TC Code	Cap.	Tol.	Part Number	Rated Voltage	TC Code	Cap.	Tol.	Part Number	
25Vdc	CH	5.3pF	±0.1pF	GRM0332C1E5R3BA01#	25Vdc	CH	6.6pF	±0.5pF	GRM0332C1E6R6DA01#	
			±0.25pF	GRM0332C1E5R3CA01#				6.7pF	±0.05pF	GRM0332C1E6R7WA01#
			±0.5pF	GRM0332C1E5R3DA01#					±0.1pF	GRM0332C1E6R7BA01#
		5.4pF	±0.05pF	GRM0332C1E5R4WA01#			±0.25pF		GRM0332C1E6R7CA01#	
			±0.1pF	GRM0332C1E5R4BA01#			±0.5pF	GRM0332C1E6R7DA01#		
			±0.25pF	GRM0332C1E5R4CA01#			6.8pF	±0.05pF	GRM0332C1E6R8WA01#	
		±0.5pF	GRM0332C1E5R4DA01#	±0.1pF				GRM0332C1E6R8BA01#		
		5.5pF	±0.05pF	GRM0332C1E5R5WA01#				±0.25pF	GRM0332C1E6R8CA01#	
			±0.1pF	GRM0332C1E5R5BA01#			±0.5pF	GRM0332C1E6R8DA01#		
			±0.25pF	GRM0332C1E5R5CA01#			6.9pF	±0.05pF	GRM0332C1E6R9WA01#	
		±0.5pF	GRM0332C1E5R5DA01#	±0.1pF				GRM0332C1E6R9BA01#		
		5.6pF	±0.05pF	GRM0332C1E5R6WA01#				±0.25pF	GRM0332C1E6R9CA01#	
			±0.1pF	GRM0332C1E5R6BA01#			±0.5pF	GRM0332C1E6R9DA01#		
			±0.25pF	GRM0332C1E5R6CA01#			7.0pF	±0.05pF	GRM0332C1E7R0WA01#	
		±0.5pF	GRM0332C1E5R6DA01#	±0.1pF				GRM0332C1E7R0BA01#		
		5.7pF	±0.05pF	GRM0332C1E5R7WA01#				±0.25pF	GRM0332C1E7R0CA01#	
			±0.1pF	GRM0332C1E5R7BA01#			±0.5pF	GRM0332C1E7R0DA01#		
			±0.25pF	GRM0332C1E5R7CA01#			7.1pF	±0.05pF	GRM0332C1E7R1WA01#	
		±0.5pF	GRM0332C1E5R7DA01#	±0.1pF				GRM0332C1E7R1BA01#		
		5.8pF	±0.05pF	GRM0332C1E5R8WA01#				±0.25pF	GRM0332C1E7R1CA01#	
			±0.1pF	GRM0332C1E5R8BA01#			±0.5pF	GRM0332C1E7R1DA01#		
			±0.25pF	GRM0332C1E5R8CA01#			7.2pF	±0.05pF	GRM0332C1E7R2WA01#	
		±0.5pF	GRM0332C1E5R8DA01#	±0.1pF				GRM0332C1E7R2BA01#		
		5.9pF	±0.05pF	GRM0332C1E5R9WA01#				±0.25pF	GRM0332C1E7R2CA01#	
			±0.1pF	GRM0332C1E5R9BA01#			±0.5pF	GRM0332C1E7R2DA01#		
			±0.25pF	GRM0332C1E5R9CA01#			7.3pF	±0.05pF	GRM0332C1E7R3WA01#	
		±0.5pF	GRM0332C1E5R9DA01#	±0.1pF				GRM0332C1E7R3BA01#		
		6.0pF	±0.05pF	GRM0332C1E6R0WA01#				±0.25pF	GRM0332C1E7R3CA01#	
			±0.1pF	GRM0332C1E6R0BA01#			±0.5pF	GRM0332C1E7R3DA01#		
			±0.25pF	GRM0332C1E6R0CA01#			7.4pF	±0.05pF	GRM0332C1E7R4WA01#	
		±0.5pF	GRM0332C1E6R0DA01#	±0.1pF				GRM0332C1E7R4BA01#		
		6.1pF	±0.05pF	GRM0332C1E6R1WA01#				±0.25pF	GRM0332C1E7R4CA01#	
			±0.1pF	GRM0332C1E6R1BA01#			±0.5pF	GRM0332C1E7R4DA01#		
			±0.25pF	GRM0332C1E6R1CA01#			7.5pF	±0.05pF	GRM0332C1E7R5WA01#	
		±0.5pF	GRM0332C1E6R1DA01#	±0.1pF				GRM0332C1E7R5BA01#		
		6.2pF	±0.05pF	GRM0332C1E6R2WA01#				±0.25pF	GRM0332C1E7R5CA01#	
			±0.1pF	GRM0332C1E6R2BA01#			±0.5pF	GRM0332C1E7R5DA01#		
			±0.25pF	GRM0332C1E6R2CA01#			7.6pF	±0.05pF	GRM0332C1E7R6WA01#	
		±0.5pF	GRM0332C1E6R2DA01#	±0.1pF				GRM0332C1E7R6BA01#		
		6.3pF	±0.05pF	GRM0332C1E6R3WA01#				±0.25pF	GRM0332C1E7R6CA01#	
			±0.1pF	GRM0332C1E6R3BA01#			±0.5pF	GRM0332C1E7R6DA01#		
			±0.25pF	GRM0332C1E6R3CA01#			7.7pF	±0.05pF	GRM0332C1E7R7WA01#	
		±0.5pF	GRM0332C1E6R3DA01#	±0.1pF				GRM0332C1E7R7BA01#		
		6.4pF	±0.05pF	GRM0332C1E6R4WA01#				±0.25pF	GRM0332C1E7R7CA01#	
			±0.1pF	GRM0332C1E6R4BA01#			±0.5pF	GRM0332C1E7R7DA01#		
			±0.25pF	GRM0332C1E6R4CA01#			7.8pF	±0.05pF	GRM0332C1E7R8WA01#	
		±0.5pF	GRM0332C1E6R4DA01#	±0.1pF				GRM0332C1E7R8BA01#		
		6.5pF	±0.05pF	GRM0332C1E6R5WA01#				±0.25pF	GRM0332C1E7R8CA01#	
±0.1pF	GRM0332C1E6R5BA01#		±0.5pF	GRM0332C1E7R8DA01#						
±0.25pF	GRM0332C1E6R5CA01#		7.9pF	±0.05pF	GRM0332C1E7R9WA01#					
±0.5pF	GRM0332C1E6R5DA01#	±0.1pF		GRM0332C1E7R9BA01#						
6.6pF	±0.05pF	GRM0332C1E6R6WA01#		±0.25pF	GRM0332C1E7R9CA01#					
	±0.1pF	GRM0332C1E6R6BA01#	±0.5pF	GRM0332C1E7R9DA01#						
	±0.25pF	GRM0332C1E6R6CA01#	8.0pF	±0.05pF	GRM0332C1E8R0WA01#					

Part number # indicates the package specification code.

GRM
 GR3
 GRJ
 GR4
 GJM
 GQM
 GA2
 GA3 GB
 GA3 GD
 GA3 GF
 LLL
 LLA
 LLM
 LLR
 NFM
 GJ4
 ZRA
 ZRB
 KRM
 KR3
 GMA
 GMD
 △Caution / Notice

GRM Series Temperature Compensating Type Part Number List

(→ 0.6×0.3mm)

Rated Voltage	TC Code	Cap.	Tol.	Part Number	Rated Voltage	TC Code	Cap.	Tol.	Part Number	
25Vdc	CH	8.0pF	±0.1pF	GRM0332C1E8R0BA01#	25Vdc	CH	9.3pF	±0.5pF	GRM0332C1E9R3DA01#	
			±0.25pF	GRM0332C1E8R0CA01#				9.4pF	±0.05pF	GRM0332C1E9R4WA01#
			±0.5pF	GRM0332C1E8R0DA01#					±0.1pF	GRM0332C1E9R4BA01#
		8.1pF	±0.05pF	GRM0332C1E8R1WA01#			±0.25pF		GRM0332C1E9R4CA01#	
			±0.1pF	GRM0332C1E8R1BA01#			±0.5pF	GRM0332C1E9R4DA01#		
			±0.25pF	GRM0332C1E8R1CA01#			9.5pF	±0.05pF	GRM0332C1E9R5WA01#	
		±0.5pF	GRM0332C1E8R1DA01#	±0.1pF				GRM0332C1E9R5BA01#		
		8.2pF	±0.05pF	GRM0332C1E8R2WA01#				±0.25pF	GRM0332C1E9R5CA01#	
			±0.1pF	GRM0332C1E8R2BA01#			±0.5pF	GRM0332C1E9R5DA01#		
			±0.25pF	GRM0332C1E8R2CA01#			9.6pF	±0.05pF	GRM0332C1E9R6WA01#	
		±0.5pF	GRM0332C1E8R2DA01#	±0.1pF				GRM0332C1E9R6BA01#		
		8.3pF	±0.05pF	GRM0332C1E8R3WA01#				±0.25pF	GRM0332C1E9R6CA01#	
			±0.1pF	GRM0332C1E8R3BA01#			±0.5pF	GRM0332C1E9R6DA01#		
			±0.25pF	GRM0332C1E8R3CA01#			9.7pF	±0.05pF	GRM0332C1E9R7WA01#	
		±0.5pF	GRM0332C1E8R3DA01#	±0.1pF				GRM0332C1E9R7BA01#		
		8.4pF	±0.05pF	GRM0332C1E8R4WA01#				±0.25pF	GRM0332C1E9R7CA01#	
			±0.1pF	GRM0332C1E8R4BA01#			±0.5pF	GRM0332C1E9R7DA01#		
			±0.25pF	GRM0332C1E8R4CA01#			9.8pF	±0.05pF	GRM0332C1E9R8WA01#	
		±0.5pF	GRM0332C1E8R4DA01#	±0.1pF				GRM0332C1E9R8BA01#		
		8.5pF	±0.05pF	GRM0332C1E8R5WA01#				±0.25pF	GRM0332C1E9R8CA01#	
			±0.1pF	GRM0332C1E8R5BA01#			±0.5pF	GRM0332C1E9R8DA01#		
			±0.25pF	GRM0332C1E8R5CA01#			9.9pF	±0.05pF	GRM0332C1E9R9WA01#	
		±0.5pF	GRM0332C1E8R5DA01#	±0.1pF				GRM0332C1E9R9BA01#		
		8.6pF	±0.05pF	GRM0332C1E8R6WA01#				±0.25pF	GRM0332C1E9R9CA01#	
			±0.1pF	GRM0332C1E8R6BA01#			±0.5pF	GRM0332C1E9R9DA01#		
			±0.25pF	GRM0332C1E8R6CA01#			10pF	±2%	GRM0332C1E100GA01#	
		±0.5pF	GRM0332C1E8R6DA01#	±5%				GRM0332C1E100JA01#		
		8.7pF	±0.05pF	GRM0332C1E8R7WA01#				11pF	±2%	GRM0332C1E110GA01#
			±0.1pF	GRM0332C1E8R7BA01#			±5%		GRM0332C1E110JA01#	
			±0.25pF	GRM0332C1E8R7CA01#			12pF		±2%	GRM0332C1E120GA01#
		±0.5pF	GRM0332C1E8R7DA01#	±5%				GRM0332C1E120JA01#		
		8.8pF	±0.05pF	GRM0332C1E8R8WA01#				13pF	±2%	GRM0332C1E130GA01#
			±0.1pF	GRM0332C1E8R8BA01#			±5%		GRM0332C1E130JA01#	
			±0.25pF	GRM0332C1E8R8CA01#			15pF		±2%	GRM0332C1E150GA01#
		±0.5pF	GRM0332C1E8R8DA01#	±5%				GRM0332C1E150JA01#		
		8.9pF	±0.05pF	GRM0332C1E8R9WA01#				16pF	±2%	GRM0332C1E160GA01#
			±0.1pF	GRM0332C1E8R9BA01#			±5%		GRM0332C1E160JA01#	
			±0.25pF	GRM0332C1E8R9CA01#			18pF		±2%	GRM0332C1E180GA01#
		±0.5pF	GRM0332C1E8R9DA01#	±5%				GRM0332C1E180JA01#		
		9.0pF	±0.05pF	GRM0332C1E9R0WA01#				20pF	±2%	GRM0332C1E200GA01#
			±0.1pF	GRM0332C1E9R0BA01#			±5%		GRM0332C1E200JA01#	
			±0.25pF	GRM0332C1E9R0CA01#			22pF		±2%	GRM0332C1E220GA01#
		±0.5pF	GRM0332C1E9R0DA01#	±5%				GRM0332C1E220JA01#		
		9.1pF	±0.05pF	GRM0332C1E9R1WA01#				24pF	±2%	GRM0332C1E240GA01#
			±0.1pF	GRM0332C1E9R1BA01#			±5%		GRM0332C1E240JA01#	
			±0.25pF	GRM0332C1E9R1CA01#			27pF		±2%	GRM0332C1E270GA01#
		±0.5pF	GRM0332C1E9R1DA01#	±5%				GRM0332C1E270JA01#		
		9.2pF	±0.05pF	GRM0332C1E9R2WA01#				30pF	±2%	GRM0332C1E300GA01#
			±0.1pF	GRM0332C1E9R2BA01#			±5%		GRM0332C1E300JA01#	
			±0.25pF	GRM0332C1E9R2CA01#			33pF		±2%	GRM0332C1E330GA01#
		±0.5pF	GRM0332C1E9R2DA01#	±5%				GRM0332C1E330JA01#		
		9.3pF	±0.05pF	GRM0332C1E9R3WA01#				36pF	±2%	GRM0332C1E360GA01#
			±0.1pF	GRM0332C1E9R3BA01#			±5%		GRM0332C1E360JA01#	
			±0.25pF	GRM0332C1E9R3CA01#			39pF		±2%	GRM0332C1E390GA01#

Part number # indicates the package specification code.

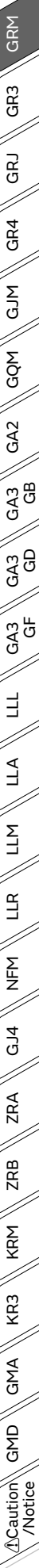

GRM Series Temperature Compensating Type Part Number List

(→ 0.6×0.3mm)

Rated Voltage	TC Code	Cap.	Tol.	Part Number		Rated Voltage	TC Code	Cap.	Tol.	Part Number	
25Vdc	CH	39pF	±5%	GRM0332C1E390JA01#		25Vdc	CJ	2.6pF	±0.05pF	GRM0333C1E2R6WA01#	
			±2%	GRM0332C1E430GA01#					±0.1pF	GRM0333C1E2R6BA01#	
		±5%	GRM0332C1E430JA01#		±0.25pF				GRM0333C1E2R6CA01#		
		47pF	±2%	GRM0332C1E470GA01#				2.7pF	±0.05pF	GRM0333C1E2R7WA01#	
			±5%	GRM0332C1E470JA01#					±0.1pF	GRM0333C1E2R7BA01#	
		±2%	GRM0332C1E510GA01#		±0.25pF				GRM0333C1E2R7CA01#		
		51pF	±5%	GRM0332C1E510JA01#				2.8pF	±0.05pF	GRM0333C1E2R8WA01#	
			±2%	GRM0332C1E560GA01#					±0.1pF	GRM0333C1E2R8BA01#	
		±5%	GRM0332C1E560JA01#		±0.25pF				GRM0333C1E2R8CA01#		
		56pF	±2%	GRM0332C1E620GA01#				2.9pF	±0.05pF	GRM0333C1E2R9WA01#	
			±5%	GRM0332C1E620JA01#					±0.1pF	GRM0333C1E2R9BA01#	
		±2%	GRM0332C1E680GA01#		±0.25pF				GRM0333C1E2R9CA01#		
		62pF	±5%	GRM0332C1E680JA01#				3.0pF	±0.05pF	GRM0333C1E3R0WA01#	
			±2%	GRM0332C1E750GA01#					±0.1pF	GRM0333C1E3R0BA01#	
		±5%	GRM0332C1E750JA01#		±0.25pF				GRM0333C1E3R0CA01#		
		75pF	±2%	GRM0332C1E820GA01#				3.1pF	±0.05pF	GRM0333C1E3R1WA01#	
			±5%	GRM0332C1E820JA01#					±0.1pF	GRM0333C1E3R1BA01#	
		±2%	GRM0332C1E910GA01#		±0.25pF				GRM0333C1E3R1CA01#		
		82pF	±5%	GRM0332C1E910JA01#				3.2pF	±0.05pF	GRM0333C1E3R2WA01#	
			±2%	GRM0332C1E101GA01#					±0.1pF	GRM0333C1E3R2BA01#	
		±5%	GRM0332C1E101JA01#		±0.25pF				GRM0333C1E3R2CA01#		
		91pF	±2%	GRM0332C1E111GA01#				3.3pF	±0.05pF	GRM0333C1E3R3WA01#	
			±5%	GRM0332C1E111JA01#					±0.1pF	GRM0333C1E3R3BA01#	
		±2%	GRM0332C1E271GA01#		±0.25pF				GRM0333C1E3R3CA01#		
	100pF	±5%	GRM0332C1E271JA01#		3.4pF		±0.05pF	GRM0333C1E3R4WA01#			
		±2%	GRM0332C1E331GA01#				±0.1pF	GRM0333C1E3R4BA01#			
	±5%	GRM0332C1E331JA01#		±0.25pF			GRM0333C1E3R4CA01#				
	110pF	±2%	GRM0332C1E391GA01#		3.5pF		±0.05pF	GRM0333C1E3R5WA01#			
		±5%	GRM0332C1E391JA01#				±0.1pF	GRM0333C1E3R5BA01#			
	±2%	GRM0332C1E471GA01#		±0.25pF			GRM0333C1E3R5CA01#				
	127pF	±5%	GRM0332C1E471JA01#		3.6pF		±0.05pF	GRM0333C1E3R6WA01#			
		±2%	GRM0332C1E561GA01#				±0.1pF	GRM0333C1E3R6BA01#			
	±5%	GRM0332C1E561JA01#		±0.25pF			GRM0333C1E3R6CA01#				
	150pF	±2%	GRM0332C1E681GA01#		3.7pF		±0.05pF	GRM0333C1E3R7WA01#			
		±5%	GRM0332C1E681JA01#				±0.1pF	GRM0333C1E3R7BA01#			
	±2%	GRM0332C1E821GA01#		±0.25pF			GRM0333C1E3R7CA01#				
	162pF	±5%	GRM0332C1E821JA01#		3.8pF		±0.05pF	GRM0333C1E3R8WA01#			
		±2%	GRM0332C1E102GA01#				±0.1pF	GRM0333C1E3R8BA01#			
	±5%	GRM0332C1E102JA01#		±0.25pF			GRM0333C1E3R8CA01#				
	CJ	2.1pF	±0.05pF	GRM0333C1E2R1WA01#			CK	0.10pF	±0.05pF	GRM0334C1ER10WA01#	
			±0.1pF	GRM0333C1E2R1BA01#					±0.05pF	GRM0334C1ER20WA01#	
			±0.25pF	GRM0333C1E2R1CA01#					±0.1pF	GRM0334C1ER20BA01#	
		2.2pF	±0.05pF	GRM0333C1E2R2WA01#				0.20pF	±0.05pF	GRM0334C1ER30WA01#	
			±0.1pF	GRM0333C1E2R2BA01#					±0.1pF	GRM0334C1ER30BA01#	
			±0.25pF	GRM0333C1E2R2CA01#					0.30pF	±0.05pF	GRM0334C1ER40WA01#
		2.3pF	±0.05pF	GRM0333C1E2R3WA01#				±0.1pF		GRM0334C1ER40BA01#	
			±0.1pF	GRM0333C1E2R3BA01#				0.40pF		±0.05pF	GRM0334C1ER50WA01#
			±0.25pF	GRM0333C1E2R3CA01#					±0.1pF	GRM0334C1ER50BA01#	
2.4pF		±0.05pF	GRM0333C1E2R4WA01#		0.50pF	±0.05pF			GRM0334C1ER60WA01#		
		±0.1pF	GRM0333C1E2R4BA01#			±0.1pF		GRM0334C1ER60BA01#			
		±0.25pF	GRM0333C1E2R4CA01#			0.60pF		±0.05pF	GRM0334C1ER70WA01#		
2.5pF	±0.05pF	GRM0333C1E2R5WA01#		±0.1pF	GRM0334C1ER70BA01#						
	±0.1pF	GRM0333C1E2R5BA01#		0.70pF	±0.05pF						
	±0.25pF	GRM0333C1E2R5CA01#									

- GRM
- GR3
- GRJ
- GR4
- GJM
- GQM
- GQ2
- GA3 GB
- GA3 GD
- GA3 GF
- LLL
- LLA
- LLM
- LLR
- NFM
- GJ4
- ZRA
- ZRB
- KRM
- KR3
- GMA
- GMD
- ⚠Caution /Notice

Part number # indicates the package specification code.

GRM Series Temperature Compensating Type Part Number List

(→ 0.6×0.3mm)

Rated Voltage	TC Code	Cap.	Tol.	Part Number
25Vdc	CK	0.70pF	±0.1pF	GRM0334C1ER70BA01#
			±0.05pF	GRM0334C1ER80WA01#
		0.80pF	±0.1pF	GRM0334C1ER80BA01#
			±0.05pF	GRM0334C1ER90WA01#
		0.90pF	±0.1pF	GRM0334C1ER90BA01#
			±0.05pF	GRM0334C1E1R0WA01#
		1.0pF	±0.1pF	GRM0334C1E1R0BA01#
			±0.25pF	GRM0334C1E1R0CA01#
			±0.05pF	GRM0334C1E1R1WA01#
		1.1pF	±0.1pF	GRM0334C1E1R1BA01#
			±0.25pF	GRM0334C1E1R1CA01#
			±0.05pF	GRM0334C1E1R2WA01#
		1.2pF	±0.1pF	GRM0334C1E1R2BA01#
			±0.25pF	GRM0334C1E1R2CA01#
			±0.05pF	GRM0334C1E1R3WA01#
		1.3pF	±0.1pF	GRM0334C1E1R3BA01#
			±0.25pF	GRM0334C1E1R3CA01#
			±0.05pF	GRM0334C1E1R4WA01#
		1.4pF	±0.1pF	GRM0334C1E1R4BA01#
			±0.25pF	GRM0334C1E1R4CA01#
			±0.05pF	GRM0334C1E1R5WA01#
		1.5pF	±0.1pF	GRM0334C1E1R5BA01#
			±0.25pF	GRM0334C1E1R5CA01#
			±0.05pF	GRM0334C1E1R6WA01#
		1.6pF	±0.1pF	GRM0334C1E1R6BA01#
			±0.25pF	GRM0334C1E1R6CA01#
			±0.05pF	GRM0334C1E1R7WA01#
		1.7pF	±0.1pF	GRM0334C1E1R7BA01#
			±0.25pF	GRM0334C1E1R7CA01#
			±0.05pF	GRM0334C1E1R8WA01#
		1.8pF	±0.1pF	GRM0334C1E1R8BA01#
			±0.25pF	GRM0334C1E1R8CA01#
			±0.05pF	GRM0334C1E1R9WA01#
		1.9pF	±0.1pF	GRM0334C1E1R9BA01#
			±0.25pF	GRM0334C1E1R9CA01#
			2.0pF	±0.05pF
		±0.1pF		GRM0334C1E2R0BA01#
		±0.25pF		GRM0334C1E2R0CA01#

1.0×0.5mm

Rated Voltage	TC Code	Cap.	Tol.	Part Number
100Vdc	COG	120pF	±2%	GRM1555C2A121GE01#
			±5%	GRM1555C2A121JE01#
		150pF	±2%	GRM1555C2A151GE01#
			±5%	GRM1555C2A151JE01#
		180pF	±2%	GRM1555C2A181GE01#
			±5%	GRM1555C2A181JE01#
		220pF	±2%	GRM1555C2A221GE01#
			±5%	GRM1555C2A221JE01#
		270pF	±2%	GRM1555C2A271GE01#
			±5%	GRM1555C2A271JE01#
		330pF	±2%	GRM1555C2A331GE01#

Rated Voltage	TC Code	Cap.	Tol.	Part Number
100Vdc	COG	330pF	±5%	GRM1555C2A331JE01#
			±2%	GRM1555C2A391GE01#
		390pF	±5%	GRM1555C2A391JE01#
			±2%	GRM1555C2A471GE01#
		470pF	±5%	GRM1555C2A471JE01#
			±2%	GRM1555C2A561GE01#
		560pF	±5%	GRM1555C2A561JE01#
			±2%	GRM1555C2A681GE01#
		680pF	±5%	GRM1555C2A681JE01#
			±2%	GRM1555C2A821GE01#
		820pF	±5%	GRM1555C2A821JE01#
			±2%	GRM1555C2A102GE01#
		1000pF	±5%	GRM1555C2A102JE01#
			270pF	±1%
		±2%		GRM1555C1H271GA01#
		±5%		GRM1555C1H271JA01#
		330pF	±1%	GRM1555C1H331FA01#
			±2%	GRM1555C1H331GA01#
			±5%	GRM1555C1H331JA01#
		390pF	±1%	GRM1555C1H391FA01#
			±2%	GRM1555C1H391GA01#
			±5%	GRM1555C1H391JA01#
		470pF	±1%	GRM1555C1H471FA01#
			±2%	GRM1555C1H471GA01#
±5%	GRM1555C1H471JA01#			
560pF	±1%	GRM1555C1H561FA01#		
	±2%	GRM1555C1H561GA01#		
	±5%	GRM1555C1H561JA01#		
680pF	±1%	GRM1555C1H681FA01#		
	±2%	GRM1555C1H681GA01#		
	±5%	GRM1555C1H681JA01#		
820pF	±1%	GRM1555C1H821FA01#		
	±2%	GRM1555C1H821GA01#		
	±5%	GRM1555C1H821JA01#		
1000pF	±1%	GRM1555C1H102FA01#		
	±2%	GRM1555C1H102GA01#		
	±5%	GRM1555C1H102JA01#		
1200pF	±2%	GRM1555C1H122GA01#		
	±5%	GRM1555C1H122JA01#		
	1500pF	±2%	GRM1555C1H152GA01#	
±5%		GRM1555C1H152JA01#		
1800pF	±2%	GRM1555C1H182GA01#		
	±5%	GRM1555C1H182JA01#		
2200pF	±2%	GRM1555C1H222GA01#		
	±5%	GRM1555C1H222JA01#		
2700pF	±2%	GRM1555C1H272GE01#		
	±5%	GRM1555C1H272JE01#		
3300pF	±2%	GRM1555C1H332GE01#		
	±5%	GRM1555C1H332JE01#		
3900pF	±2%	GRM1555C1H392GE01#		
	±5%	GRM1555C1H392JE01#		
4700pF	±2%	GRM1555C1H472GE01#		
	±5%	GRM1555C1H472JE01#		
5600pF	±2%	GRM1555C1H562GE01#		

Part number # indicates the package specification code.

GRM
 GR3
 GRJ
 GR4
 GJM
 GQM
 GA2
 GA3 GB
 GA3 GD
 GA3 GF
 LLL
 LLA
 LLM
 LLR
 NFM
 GJ4
 ZRA
 ZRB
 KRM
 KR3
 GMA
 GMD
 △Caution / Notice

GRM Series Temperature Compensating Type Part Number List

(→ 1.0×0.5mm)

Rated Voltage	TC Code	Cap.	Tol.	Part Number	
50Vdc	COG	560pF	±5%	GRM1555C1H562JE01#	
			±2%	GRM1555C1H682GE01#	
		680pF	±5%	GRM1555C1H682JE01#	
			±2%	GRM1555C1H822GE01#	
		820pF	±5%	GRM1555C1H822JE01#	
			±2%	GRM1552C1H271GA01#	
		CH	270pF	±5%	GRM1552C1H271JA01#
				±2%	GRM1552C1H331GA01#
	330pF		±5%	GRM1552C1H331JA01#	
			±2%	GRM1552C1H391GA01#	
	390pF		±5%	GRM1552C1H391JA01#	
			±2%	GRM1552C1H471GA01#	
	470pF		±5%	GRM1552C1H471JA01#	
			±2%	GRM1552C1H561GA01#	
	560pF		±5%	GRM1552C1H561JA01#	
			±2%	GRM1552C1H681GA01#	
	680pF		±5%	GRM1552C1H681JA01#	
			±2%	GRM1552C1H821GA01#	
	820pF	±5%	GRM1552C1H821JA01#		
		±2%	GRM1552C1H102GA01#		
1000pF	±5%	GRM1552C1H102JA01#			
	±2%	GRM1555C1A103GE01#			
35Vdc	COG	10000pF	±5%	GRM1555C1E103JE01#	
			±2%	GRM1555C1E103GE01#	
25Vdc	COG	10000pF	±5%	GRM1555C1E103JE01#	
			±2%	GRM1555C1E103GE01#	
10Vdc	U2J	2400pF	±5%	GRM1557U1A242JA01#	
			±5%	GRM1557U1A272JA01#	
		2700pF	±5%	GRM1557U1A302JA01#	
			±5%	GRM1557U1A332JA01#	
		3000pF	±5%	GRM1557U1A362JA01#	
			±5%	GRM1557U1A392JA01#	
		3300pF	±5%	GRM1557U1A432JA01#	
			±5%	GRM1557U1A472JA01#	
	UJ	2400pF	±5%	GRM1553U1A242JA01#	
			±5%	GRM1553U1A272JA01#	
		2700pF	±5%	GRM1553U1A302JA01#	
			±5%	GRM1553U1A332JA01#	
		3000pF	±5%	GRM1553U1A362JA01#	
			±5%	GRM1553U1A392JA01#	
		3300pF	±5%	GRM1553U1A432JA01#	
			±5%	GRM1553U1A472JA01#	

1.6×0.8mm

Rated Voltage	TC Code	Cap.	Tol.	Part Number
250Vdc	COG	10pF	±1%	GRM1885C2E100FW07#
			±2%	GRM1885C2E100GW07#
			±5%	GRM1885C2E100JW07#
		12pF	±1%	GRM1885C2E120FW07#
			±2%	GRM1885C2E120GW07#
			±5%	GRM1885C2E120JW07#
	15pF	±1%	GRM1885C2E150FW07#	
		±2%	GRM1885C2E150GW07#	

Rated Voltage	TC Code	Cap.	Tol.	Part Number		
250Vdc	COG	15pF	±5%	GRM1885C2E150JW07#		
			±1%	GRM1885C2E180FW07#		
		18pF	±2%	GRM1885C2E180GW07#		
			±5%	GRM1885C2E180JW07#		
			±1%	GRM1885C2E220FW07#		
		22pF	±2%	GRM1885C2E220GW07#		
			±5%	GRM1885C2E220JW07#		
			±1%	GRM1885C2E270FW07#		
		27pF	±2%	GRM1885C2E270GW07#		
			±5%	GRM1885C2E270JW07#		
			±1%	GRM1885C2E330FW07#		
		33pF	±2%	GRM1885C2E330GW07#		
	±5%		GRM1885C2E330JW07#			
	±1%		GRM1885C2E390FW07#			
	39pF	±2%	GRM1885C2E390GW07#			
		±5%	GRM1885C2E390JW07#			
		±1%	GRM1885C2E470FW07#			
	47pF	±2%	GRM1885C2E470GW07#			
		±5%	GRM1885C2E470JW07#			
		100Vdc	COG	1000pF	±5%	GRM1885C2A102JA01#
	1200pF			±5%	GRM1885C2A122JA01#	
	1300pF			±5%	GRM1885C2A132JA01#	
	1500pF			±5%	GRM1885C2A152JA01#	
	1800pF			±5%	GRM1885C2A182JA01#	
2200pF	±5%			GRM1885C2A222JA01#		
2700pF	±5%			GRM1885C2A272JA01#		
3300pF	±5%			GRM1885C2A332JA01#		
3900pF	±5%			GRM1885C2A392JA01#		
CH	CH			1000pF	±5%	GRM1882C2A102JA01#
				1200pF	±5%	GRM1882C2A122JA01#
				1300pF	±5%	GRM1882C2A132JA01#
		1500pF	±5%	GRM1882C2A152JA01#		
		1800pF	±5%	GRM1882C2A182JA01#		
		2200pF	±5%	GRM1882C2A222JA01#		
		2700pF	±5%	GRM1882C2A272JA01#		
		3300pF	±5%	GRM1882C2A332JA01#		
		3900pF	±5%	GRM1882C2A392JA01#		
		50Vdc	COG	1000pF	±5%	GRM1885C1H102JA01#
				1100pF	±5%	GRM1885C1H112JA01#
				1200pF	±5%	GRM1885C1H122JA01#
1300pF	±5%			GRM1885C1H132JA01#		
1500pF	±5%			GRM1885C1H152JA01#		
1600pF	±5%			GRM1885C1H162JA01#		
1800pF	±5%			GRM1885C1H182JA01#		
2000pF	±5%			GRM1885C1H202JA01#		
2200pF	±5%			GRM1885C1H222JA01#		
2400pF	±5%			GRM1885C1H242JA01#		
2700pF	±5%			GRM1885C1H272JA01#		
3000pF	±5%			GRM1885C1H302JA01#		
3300pF	±5%	GRM1885C1H332JA01#				
3600pF	±5%	GRM1885C1H362JA01#				
3900pF	±5%	GRM1885C1H392JA01#				
4300pF	±5%	GRM1885C1H432JA01#				
4700pF	±5%	GRM1885C1H472JA01#				

Part number # indicates the package specification code.



GRM Series Temperature Compensating Type Part Number List

(→ 1.6×0.8mm)

Rated Voltage	TC Code	Cap.	Tol.	Part Number	Rated Voltage	TC Code	Cap.	Tol.	Part Number		
50Vdc	COG	5100pF	±5%	GRM1885C1H512JA01#	50Vdc	UJ	3000pF	±5%	GRM1853U1H302JA44#		
		5600pF	±5%	GRM1885C1H562JA01#			3300pF	±5%	GRM1853U1H332JA44#		
		6200pF	±5%	GRM1885C1H622JA01#			3600pF	±5%	GRM1853U1H362JA44#		
		6800pF	±5%	GRM1885C1H682JA01#			3900pF	±5%	GRM1853U1H392JA44#		
		7500pF	±5%	GRM1885C1H752JA01#			4300pF	±5%	GRM1853U1H432JA44#		
		8200pF	±5%	GRM1885C1H822JA01#			4700pF	±5%	GRM1853U1H472JA44#		
		9100pF	±5%	GRM1885C1H912JA01#			10Vdc	SL	5600pF	±5%	GRM1851X1A562JA44#
		10000pF	±5%	GRM1885C1H103JA01#					6800pF	±5%	GRM1851X1A682JA44#
	CH	1000pF	±5%	GRM1882C1H102JA01#	8200pF	±5%			GRM1851X1A822JA44#		
		1100pF	±5%	GRM1882C1H112JA01#	1000pF	±5%			GRM1851X1A103JA44#		
		1200pF	±5%	GRM1882C1H122JA01#	1200pF	±5%			GRM1881X1A123JA01#		
		1300pF	±5%	GRM1882C1H132JA01#	1500pF	±5%			GRM1881X1A153JA01#		
		1500pF	±5%	GRM1882C1H152JA01#	1800pF	±5%			GRM1881X1A183JA01#		
		1600pF	±5%	GRM1882C1H162JA01#	2200pF	±5%			GRM1881X1A223JA01#		
		1800pF	±5%	GRM1882C1H182JA01#	2400pF	±5%			GRM1881X1A243JA01#		
		2000pF	±5%	GRM1882C1H202JA01#	2700pF	±5%			GRM1881X1A273JA01#		
		2200pF	±5%	GRM1882C1H222JA01#	3000pF	±5%		GRM1881X1A303JA01#			
		2400pF	±5%	GRM1882C1H242JA01#	3300pF	±5%		GRM1881X1A333JA01#			
		2700pF	±5%	GRM1882C1H272JA01#	U2J	5600pF		±5%	GRM1857U1A562JA44#		
		3000pF	±5%	GRM1882C1H302JA01#		6800pF		±5%	GRM1857U1A682JA44#		
		3300pF	±5%	GRM1882C1H332JA01#		8200pF		±5%	GRM1857U1A822JA44#		
		3600pF	±5%	GRM1882C1H362JA01#		1000pF		±5%	GRM1857U1A103JA44#		
		3900pF	±5%	GRM1882C1H392JA01#		1200pF		±5%	GRM1887U1A123JA01#		
		4300pF	±5%	GRM1882C1H432JA01#		1500pF		±5%	GRM1887U1A153JA01#		
		4700pF	±5%	GRM1882C1H472JA01#		1800pF		±5%	GRM1887U1A183JA01#		
		5100pF	±5%	GRM1882C1H512JA01#		2200pF		±5%	GRM1887U1A223JA01#		
		5600pF	±5%	GRM1882C1H562JA01#		2400pF	±5%	GRM1887U1A243JA01#			
		6200pF	±5%	GRM1882C1H622JA01#		2700pF	±5%	GRM1887U1A273JA01#			
		6800pF	±5%	GRM1882C1H682JA01#	3000pF	±5%	GRM1887U1A303JA01#				
		7500pF	±5%	GRM1882C1H752JA01#	3300pF	±5%	GRM1887U1A333JA01#				
		8200pF	±5%	GRM1882C1H822JA01#	UJ	5600pF	±5%	GRM1853U1A562JA44#			
		9100pF	±5%	GRM1882C1H912JA01#		6800pF	±5%	GRM1853U1A682JA44#			
		10000pF	±5%	GRM1882C1H103JA01#		8200pF	±5%	GRM1853U1A822JA44#			
		SL	2200pF	±5%		GRM1851X1H222JA44#	1000pF	±5%	GRM1853U1A103JA44#		
			2400pF	±5%		GRM1851X1H242JA44#	1200pF	±5%	GRM1883U1A123JA01#		
			2700pF	±5%		GRM1851X1H272JA44#	1500pF	±5%	GRM1883U1A153JA01#		
			3000pF	±5%		GRM1851X1H302JA44#	1800pF	±5%	GRM1883U1A183JA01#		
			3300pF	±5%		GRM1851X1H332JA44#	2200pF	±5%	GRM1883U1A223JA01#		
			3600pF	±5%		GRM1851X1H362JA44#	2400pF	±5%	GRM1883U1A243JA01#		
			3900pF	±5%		GRM1851X1H392JA44#	2700pF	±5%	GRM1883U1A273JA01#		
	4300pF		±5%	GRM1851X1H432JA44#	3000pF	±5%	GRM1883U1A303JA01#				
	4700pF	±5%	GRM1851X1H472JA44#	3300pF	±5%	GRM1883U1A333JA01#					
	U2J	2200pF	±5%	GRM1857U1H222JA44#	6.3Vdc	SL	2400pF	±5%	GRM1881X0J243JA01#		
		2400pF	±5%	GRM1857U1H242JA44#			2700pF	±5%	GRM1881X0J273JA01#		
2700pF		±5%	GRM1857U1H272JA44#	3000pF			±5%	GRM1881X0J303JA01#			
3000pF		±5%	GRM1857U1H302JA44#	3300pF			±5%	GRM1881X0J333JA01#			
3300pF		±5%	GRM1857U1H332JA44#	U2J			2400pF	±5%	GRM1887U0J243JA01#		
3600pF		±5%	GRM1857U1H362JA44#			2700pF	±5%	GRM1887U0J273JA01#			
3900pF		±5%	GRM1857U1H392JA44#			3000pF	±5%	GRM1887U0J303JA01#			
4300pF		±5%	GRM1857U1H432JA44#			3300pF	±5%	GRM1887U0J333JA01#			
4700pF	±5%	GRM1857U1H472JA44#	UJ			2400pF	±5%	GRM1883U0J243JA01#			
UJ	2200pF	±5%		GRM1853U1H222JA44#		2700pF	±5%	GRM1883U0J273JA01#			
	2400pF	±5%		GRM1853U1H242JA44#	3000pF	±5%	GRM1883U0J303JA01#				
	2700pF	±5%		GRM1853U1H272JA44#	3300pF	±5%	GRM1883U0J333JA01#				

Part number # indicates the package specification code.



GRM Series Temperature Compensating Type Part Number List

2.0×1.25mm

Rated Voltage	TC Code	Cap.	Tol.	Part Number
630Vdc	COG	10pF	±1%	GRM21A5C2J100FWA1#
			±2%	GRM21A5C2J100GWA1#
			±5%	GRM21A5C2J100JWA1#
		12pF	±1%	GRM21A5C2J120FWA1#
			±2%	GRM21A5C2J120GWA1#
			±5%	GRM21A5C2J120JWA1#
		15pF	±1%	GRM21A5C2J150FWA1#
			±2%	GRM21A5C2J150GWA1#
			±5%	GRM21A5C2J150JWA1#
		18pF	±1%	GRM21A5C2J180FWA1#
			±2%	GRM21A5C2J180GWA1#
			±5%	GRM21A5C2J180JWA1#
		22pF	±1%	GRM21A5C2J220FWA1#
			±2%	GRM21A5C2J220GWA1#
			±5%	GRM21A5C2J220JWA1#
		27pF	±1%	GRM21A5C2J270FWA1#
			±2%	GRM21A5C2J270GWA1#
			±5%	GRM21A5C2J270JWA1#
		33pF	±1%	GRM21A5C2J330FWA1#
			±2%	GRM21A5C2J330GWA1#
			±5%	GRM21A5C2J330JWA1#
		39pF	±1%	GRM21A5C2J390FWA1#
			±2%	GRM21A5C2J390GWA1#
			±5%	GRM21A5C2J390JWA1#
		47pF	±1%	GRM21A5C2J470FWA1#
			±2%	GRM21A5C2J470GWA1#
			±5%	GRM21A5C2J470JWA1#
		56pF	±1%	GRM21A5C2J560FWA1#
			±2%	GRM21A5C2J560GWA1#
			±5%	GRM21A5C2J560JWA1#
		68pF	±1%	GRM21A5C2J680FWA1#
			±2%	GRM21A5C2J680GWA1#
			±5%	GRM21A5C2J680JWA1#
		82pF	±1%	GRM21A5C2J820FWA1#
			±2%	GRM21A5C2J820GWA1#
			±5%	GRM21A5C2J820JWA1#
		100pF	±1%	GRM21A5C2J101FWA1#
			±2%	GRM21A5C2J101GWA1#
			±5%	GRM21A5C2J101JWA1#
		120pF	±1%	GRM21A5C2J121FWA1#
			±2%	GRM21A5C2J121GWA1#
			±5%	GRM21A5C2J121JWA1#
		150pF	±1%	GRM21A5C2J151FWA1#
			±2%	GRM21A5C2J151GWA1#
			±5%	GRM21A5C2J151JWA1#
		180pF	±1%	GRM21A5C2J181FWA1#
			±2%	GRM21A5C2J181GWA1#
			±5%	GRM21A5C2J181JWA1#
		220pF	±1%	GRM21A5C2J221FWA1#
			±2%	GRM21A5C2J221GWA1#
			±5%	GRM21A5C2J221JWA1#
		270pF	±1%	GRM21A5C2J271FWA1#

Rated Voltage	TC Code	Cap.	Tol.	Part Number
630Vdc	COG	270pF	±2%	GRM21A5C2J271GWA1#
			±5%	GRM21A5C2J271JWA1#
		330pF	±1%	GRM21A5C2J331FWA1#
			±2%	GRM21A5C2J331GWA1#
			±5%	GRM21A5C2J331JWA1#
			±5%	GRM21A5C2J331JWA1#
		390pF	±1%	GRM21A5C2J391FWA1#
			±2%	GRM21A5C2J391GWA1#
			±5%	GRM21A5C2J391JWA1#
			±5%	GRM21A5C2J391JWA1#
		470pF	±1%	GRM21A5C2J471FWA1#
			±2%	GRM21A5C2J471GWA1#
			±5%	GRM21A5C2J471JWA1#
			±5%	GRM21A5C2J471JWA1#
		560pF	±1%	GRM21A5C2J561FWA1#
			±2%	GRM21A5C2J561GWA1#
			±5%	GRM21A5C2J561JWA1#
			±5%	GRM21A5C2J561JWA1#
		680pF	±1%	GRM21B5C2J681FWA3#
			±2%	GRM21B5C2J681GWA3#
			±5%	GRM21B5C2J681JWA3#
			±5%	GRM21B5C2J681JWA3#
		820pF	±1%	GRM21B5C2J821FWA3#
			±2%	GRM21B5C2J821GWA3#
			±5%	GRM21B5C2J821JWA3#
			±5%	GRM21B5C2J821JWA3#
		1000pF	±1%	GRM21B5C2J102FWA3#
			±2%	GRM21B5C2J102GWA3#
			±5%	GRM21B5C2J102JWA3#
			±5%	GRM21B5C2J102JWA3#
		1200pF	±1%	GRM21B5C2J122FWA3#
			±2%	GRM21B5C2J122GWA3#
			±5%	GRM21B5C2J122JWA3#
			±5%	GRM21B5C2J122JWA3#
		1500pF	±1%	GRM21B5C2J152FWAA#
			±2%	GRM21B5C2J152GWAA#
			±5%	GRM21B5C2J152JWAA#
			±5%	GRM21B5C2J152JWAA#
		1800pF	±1%	GRM21B5C2J182FWAA#
			±2%	GRM21B5C2J182GWAA#
			±5%	GRM21B5C2J182JWAA#
			±5%	GRM21B5C2J182JWAA#
2200pF	±1%	GRM21B5C2J222FWAA#		
	±2%	GRM21B5C2J222GWAA#		
	±5%	GRM21B5C2J222JWAA#		
	±5%	GRM21B5C2J222JWAA#		
250Vdc	COG	10pF	±1%	GRM21A5C2E100FW01#
			±2%	GRM21A5C2E100GW01#
			±5%	GRM21A5C2E100JW01#
		12pF	±1%	GRM21A5C2E120FW01#
			±2%	GRM21A5C2E120GW01#
			±5%	GRM21A5C2E120JW01#
		15pF	±1%	GRM21A5C2E150FW01#
			±2%	GRM21A5C2E150GW01#
			±5%	GRM21A5C2E150JW01#
		18pF	±1%	GRM21A5C2E180FW01#
			±2%	GRM21A5C2E180GW01#
			±5%	GRM21A5C2E180JW01#
22pF	±1%	GRM21A5C2E220FW01#		
	±2%	GRM21A5C2E220GW01#		
	±5%	GRM21A5C2E220JW01#		
27pF	±1%	GRM21A5C2E270FW01#		
	±2%	GRM21A5C2E270GW01#		
	±5%	GRM21A5C2E270JW01#		
33pF	±1%	GRM21A5C2E330FW01#		

Part number # indicates the package specification code.

- GRM
- GR3
- GRJ
- GR4
- GJM
- GQM
- GA2
- GA3 GB
- GA3 GD
- GA3 GF
- LLL
- LLA
- LLM
- LLR
- NFM
- GJ4
- ZRA
- ZRB
- KRM
- KR3
- GMA
- GMD
- ⚠Caution /Notice

GRM Series Temperature Compensating Type Part Number List

(→ 2.0×1.25mm)

Rated Voltage	TC Code	Cap.	Tol.	Part Number	Rated Voltage	TC Code	Cap.	Tol.	Part Number	
250Vdc	COG	33pF	±2%	GRM21A5C2E330GW01#	250Vdc	COG	1000pF	±2%	GRM21A5C2E102GWA1#	
			±5%	GRM21A5C2E330JW01#				±5%	GRM21A5C2E102JWA1#	
		39pF	±1%	GRM21A5C2E390FW01#			1200pF	±1%	GRM21A5C2E122FWA1#	
			±2%	GRM21A5C2E390GW01#				±2%	GRM21A5C2E122GWA1#	
			±5%	GRM21A5C2E390JW01#				±5%	GRM21A5C2E122JWA1#	
		47pF	±1%	GRM21A5C2E470FW01#			1500pF	±1%	GRM21A5C2E152FWA1#	
			±2%	GRM21A5C2E470GW01#				±2%	GRM21A5C2E152GWA1#	
			±5%	GRM21A5C2E470JW01#				±5%	GRM21A5C2E152JWA1#	
		56pF	±1%	GRM21A5C2E560FW01#			1800pF	±1%	GRM21A5C2E182FWA1#	
			±2%	GRM21A5C2E560GW01#				±2%	GRM21A5C2E182GWA1#	
			±5%	GRM21A5C2E560JW01#				±5%	GRM21A5C2E182JWA1#	
		68pF	±1%	GRM21A5C2E680FW01#			2200pF	±1%	GRM21A5C2E222FWA1#	
			±2%	GRM21A5C2E680GW01#				±2%	GRM21A5C2E222GWA1#	
			±5%	GRM21A5C2E680JW01#				±5%	GRM21A5C2E222JWA1#	
		82pF	±1%	GRM21A5C2E820FW01#			2700pF	±1%	GRM21A5C2E272FWA1#	
			±2%	GRM21A5C2E820GW01#				±2%	GRM21A5C2E272GWA1#	
			±5%	GRM21A5C2E820JW01#				±5%	GRM21A5C2E272JWA1#	
		100pF	±1%	GRM21A5C2E101FW01#			3300pF	±1%	GRM21B5C2E332FWA1#	
			±2%	GRM21A5C2E101GW01#				±2%	GRM21B5C2E332GWA1#	
			±5%	GRM21A5C2E101JW01#				±5%	GRM21B5C2E332JWA1#	
		120pF	±1%	GRM21A5C2E121FW01#			3900pF	±1%	GRM21B5C2E392FWA1#	
			±2%	GRM21A5C2E121GW01#				±2%	GRM21B5C2E392GWA1#	
			±5%	GRM21A5C2E121JW01#				±5%	GRM21B5C2E392JWA1#	
		150pF	±1%	GRM21A5C2E151FW01#			4700pF	±1%	GRM21B5C2E472FWA1#	
			±2%	GRM21A5C2E151GW01#				±2%	GRM21B5C2E472GWA1#	
			±5%	GRM21A5C2E151JW01#				±5%	GRM21B5C2E472JWA1#	
		180pF	±1%	GRM21A5C2E181FW01#			5600pF	±1%	GRM21B5C2E562FWAA#	
			±2%	GRM21A5C2E181GW01#				±2%	GRM21B5C2E562GWAA#	
			±5%	GRM21A5C2E181JW01#				±5%	GRM21B5C2E562JWAA#	
		220pF	±1%	GRM21A5C2E221FW01#			6800pF	±1%	GRM21B5C2E682FWAA#	
			±2%	GRM21A5C2E221GW01#				±2%	GRM21B5C2E682GWAA#	
			±5%	GRM21A5C2E221JW01#				±5%	GRM21B5C2E682JWAA#	
		270pF	±1%	GRM21A5C2E271FW01#			8200pF	±1%	GRM21B5C2E822FWAA#	
			±2%	GRM21A5C2E271GW01#				±2%	GRM21B5C2E822GWAA#	
			±5%	GRM21A5C2E271JW01#				±5%	GRM21B5C2E822JWAA#	
		330pF	±1%	GRM21A5C2E331FW01#			10000pF	±1%	GRM21B5C2E103FWAA#	
			±2%	GRM21A5C2E331GW01#				±2%	GRM21B5C2E103GWAA#	
			±5%	GRM21A5C2E331JW01#				±5%	GRM21B5C2E103JWAA#	
		390pF	±1%	GRM21A5C2E391FWA1#			U2J	100pF	±5%	GRM21A7U2E101JW31#
			±2%	GRM21A5C2E391GWA1#				120pF	±5%	GRM21A7U2E121JW31#
			±5%	GRM21A5C2E391JWA1#				150pF	±5%	GRM21A7U2E151JW31#
		470pF	±1%	GRM21A5C2E471FWA1#			180pF	±5%	GRM21A7U2E181JW31#	
			±2%	GRM21A5C2E471GWA1#			220pF	±5%	GRM21A7U2E221JW31#	
			±5%	GRM21A5C2E471JWA1#			270pF	±5%	GRM21A7U2E271JW31#	
		560pF	±1%	GRM21A5C2E561FWA1#			330pF	±5%	GRM21A7U2E331JW31#	
			±2%	GRM21A5C2E561GWA1#			390pF	±5%	GRM21A7U2E391JW31#	
			±5%	GRM21A5C2E561JWA1#			470pF	±5%	GRM21A7U2E471JW31#	
		680pF	±1%	GRM21A5C2E681FWA1#			560pF	±5%	GRM21A7U2E561JW31#	
			±2%	GRM21A5C2E681GWA1#			680pF	±5%	GRM21A7U2E681JW31#	
			±5%	GRM21A5C2E681JWA1#			820pF	±5%	GRM21A7U2E821JW31#	
		820pF	±1%	GRM21A5C2E821FWA1#			1000pF	±5%	GRM21A7U2E102JW31#	
			±2%	GRM21A5C2E821GWA1#			1200pF	±5%	GRM21A7U2E122JW31#	
			±5%	GRM21A5C2E821JWA1#			1500pF	±5%	GRM21A7U2E152JW31#	
		1000pF	±1%	GRM21A5C2E102FWA1#			1800pF	±5%	GRM21A7U2E182JW31#	

Part number # indicates the package specification code.



GRM Series Temperature Compensating Type Part Number List

(→ 2.0×1.25mm)

Rated Voltage	TC Code	Cap.	Tol.	Part Number	Rated Voltage	TC Code	Cap.	Tol.	Part Number				
250Vdc	U2J	2200pF	±5%	GRM21A7U2E222JW31#	200Vdc	COG	220pF	±1%	GRM21A5C2D221FW01#				
		2700pF	±5%	GRM21B7U2E272JW32#				±2%	GRM21A5C2D221GW01#				
		3300pF	±5%	GRM21B7U2E332JW32#				±5%	GRM21A5C2D221JW01#				
		3900pF	±5%	GRM21B7U2E392JW32#			270pF	±1%	GRM21A5C2D271FW01#				
		4700pF	±5%	GRM21B7U2E472JW32#				±2%	GRM21A5C2D271GW01#				
		5600pF	±5%	GRM21B7U2E562JW32#				±5%	GRM21A5C2D271JW01#				
200Vdc	COG	10pF	±1%	GRM21A5C2D100FW01#			330pF	COG	100pF	±1%	GRM21A5C2D331FW01#		
			±2%	GRM21A5C2D100GW01#						±2%	GRM21A5C2D331GW01#		
			±5%	GRM21A5C2D100JW01#						±5%	GRM21A5C2D331JW01#		
		12pF	±1%	GRM21A5C2D120FW01#					U2J	100pF	±5%	GRM21A7U2D101JW31#	
			±2%	GRM21A5C2D120GW01#							±5%	GRM21A7U2D121JW31#	
			±5%	GRM21A5C2D120JW01#							±5%	GRM21A7U2D151JW31#	
		15pF	±1%	GRM21A5C2D150FW01#							180pF	±5%	GRM21A7U2D181JW31#
			±2%	GRM21A5C2D150GW01#							220pF	±5%	GRM21A7U2D221JW31#
			±5%	GRM21A5C2D150JW01#							270pF	±5%	GRM21A7U2D271JW31#
		18pF	±1%	GRM21A5C2D180FW01#							330pF	±5%	GRM21A7U2D331JW31#
			±2%	GRM21A5C2D180GW01#							390pF	±5%	GRM21A7U2D391JW31#
			±5%	GRM21A5C2D180JW01#							470pF	±5%	GRM21A7U2D471JW31#
		22pF	±1%	GRM21A5C2D220FW01#	560pF	±5%	GRM21A7U2D561JW31#						
			±2%	GRM21A5C2D220GW01#	680pF	±5%	GRM21A7U2D681JW31#						
			±5%	GRM21A5C2D220JW01#	820pF	±5%	GRM21A7U2D821JW31#						
		27pF	±1%	GRM21A5C2D270FW01#	1000pF	±5%	GRM21A7U2D102JW31#						
			±2%	GRM21A5C2D270GW01#	1200pF	±5%	GRM21A7U2D122JW31#						
			±5%	GRM21A5C2D270JW01#	1500pF	±5%	GRM21A7U2D152JW31#						
		33pF	±1%	GRM21A5C2D330FW01#	1800pF	±5%	GRM21A7U2D182JW31#						
			±2%	GRM21A5C2D330GW01#	2200pF	±5%	GRM21A7U2D222JW31#						
			±5%	GRM21A5C2D330JW01#	2700pF	±5%	GRM21B7U2D272JW32#						
		39pF	±1%	GRM21A5C2D390FW01#	3300pF	±5%	GRM21B7U2D332JW32#						
			±2%	GRM21A5C2D390GW01#	3900pF	±5%	GRM21B7U2D392JW32#						
			±5%	GRM21A5C2D390JW01#	4700pF	±5%	GRM21B7U2D472JW32#						
		47pF	±1%	GRM21A5C2D470FW01#	5600pF	±5%	GRM21B7U2D562JW32#						
			±2%	GRM21A5C2D470GW01#	100Vdc	COG	1000pF	±5%	GRM2165C2A102JA01#				
			±5%	GRM21A5C2D470JW01#			1100pF	±5%	GRM2165C2A112JA01#				
		56pF	±1%	GRM21A5C2D560FW01#			1200pF	±5%	GRM2165C2A122JA01#				
			±2%	GRM21A5C2D560GW01#			1300pF	±5%	GRM2165C2A132JA01#				
			±5%	GRM21A5C2D560JW01#			1500pF	±5%	GRM2165C2A152JA01#				
		68pF	±1%	GRM21A5C2D680FW01#			1600pF	±5%	GRM2165C2A162JA01#				
			±2%	GRM21A5C2D680GW01#			1800pF	±5%	GRM2165C2A182JA01#				
			±5%	GRM21A5C2D680JW01#			2000pF	±5%	GRM2165C2A202JA01#				
		82pF	±1%	GRM21A5C2D820FW01#			2200pF	±5%	GRM2165C2A222JA01#				
			±2%	GRM21A5C2D820GW01#			2400pF	±5%	GRM2165C2A242JA01#				
			±5%	GRM21A5C2D820JW01#			2700pF	±5%	GRM2165C2A272JA01#				
		100pF	±1%	GRM21A5C2D101FW01#			3000pF	±5%	GRM2165C2A302JA01#				
			±2%	GRM21A5C2D101GW01#	3300pF	±5%	GRM2165C2A332JA01#						
			±5%	GRM21A5C2D101JW01#	3900pF	±5%	GRM2165C2A392JA01#						
		120pF	±1%	GRM21A5C2D121FW01#	4700pF	±5%	GRM2165C2A472JA01#						
			±2%	GRM21A5C2D121GW01#	5600pF	±2%	GRM2165C2A562GA01#						
			±5%	GRM21A5C2D121JW01#		±5%	GRM2165C2A562JA01#						
		150pF	±1%	GRM21A5C2D151FW01#		±5%	GRM2195C2A562JA01#						
			±2%	GRM21A5C2D151GW01#	6800pF	±2%	GRM2165C2A682GA01#						
			±5%	GRM21A5C2D151JW01#		±5%	GRM2165C2A682JA01#						
		180pF	±1%	GRM21A5C2D181FW01#		±5%	GRM2195C2A682JA01#						
			±2%	GRM21A5C2D181GW01#	8200pF	±2%	GRM2165C2A822GA01#						
			±5%	GRM21A5C2D181JW01#		±5%	GRM2165C2A822JA01#						

Part number # indicates the package specification code.

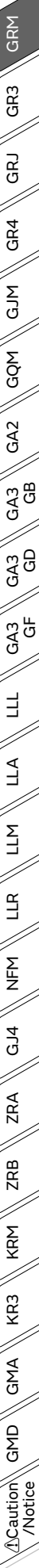

GRM Series Temperature Compensating Type Part Number List

(→ 2.0×1.25mm)

Rated Voltage	TC Code	Cap.	Tol.	Part Number	Rated Voltage	TC Code	Cap.	Tol.	Part Number		
100Vdc	COG	8200pF	±5%	GRM2195C2A822JA01#	50Vdc	COG	1100pF	±5%	GRM2195C1H113JA01#		
		10000pF	±2%	GRM2165C2A103GA01#			1200pF	±5%	GRM2195C1H123JA01#		
			±5%	GRM2165C2A103JA01#			1300pF	±5%	GRM2195C1H133JA01#		
			±5%	GRM2195C2A103JA01#			1500pF	±5%	GRM2195C1H153JA01#		
			±5%	GRM2165C2A123GA01#			1800pF	±2%	GRM2165C1H183GA01#		
		12000pF	±2%	GRM2165C2A123GA01#			±5%	GRM2165C1H183JA01#	±5%	GRM21B5C1H183JA01#	
			±5%	GRM2165C2A123JA01#			2000pF	±5%	GRM21B5C1H203JA01#		
			±5%	GRM2195C2A123JA01#			2200pF	±2%	GRM2165C1H223GA01#		
		15000pF	±2%	GRM2165C2A153GA01#			±5%	GRM2165C1H223JA01#	±5%	GRM2165C1H223JA01#	
			±5%	GRM2165C2A153JA01#			±5%	GRM21B5C1H223JA01#			
			±5%	GRM2195C2A153JA01#			2700pF	±2%	GRM2165C1H273GA01#		
		18000pF	±5%	GRM21B5C2A183JA01#			±5%	GRM2165C1H273JA01#			
		22000pF	±5%	GRM21B5C2A223JA01#			3300pF	±2%	GRM2165C1H333GA01#		
		CH	1000pF	±5%			GRM2162C2A102JA01#	±5%	GRM2165C1H333JA01#		
			1100pF	±5%			GRM2162C2A112JA01#	CH	2400pF	±5%	GRM2162C1H242JA01#
			1200pF	±5%			GRM2162C2A122JA01#		2700pF	±5%	GRM2162C1H272JA01#
			1300pF	±5%			GRM2162C2A132JA01#		3000pF	±5%	GRM2162C1H302JA01#
			1500pF	±5%			GRM2162C2A152JA01#		3300pF	±5%	GRM2162C1H332JA01#
	1600pF		±5%	GRM2162C2A162JA01#			3600pF		±5%	GRM2162C1H362JA01#	
	1800pF		±5%	GRM2162C2A182JA01#			3900pF		±5%	GRM2162C1H392JA01#	
	2000pF		±5%	GRM2162C2A202JA01#			±5%		GRM2192C1H392JA01#		
	2200pF		±5%	GRM2162C2A222JA01#			4300pF		±5%	GRM2162C1H432JA01#	
	2400pF		±5%	GRM2162C2A242JA01#			±5%		GRM2192C1H432JA01#		
	2700pF		±5%	GRM2162C2A272JA01#			4700pF		±5%	GRM2162C1H472JA01#	
	3000pF		±5%	GRM2162C2A302JA01#			±5%		GRM2192C1H472JA01#		
	3300pF		±5%	GRM2162C2A332JA01#			5100pF		±5%	GRM2192C1H512JA01#	
	3900pF		±5%	GRM2162C2A392JA01#			5600pF		±5%	GRM2192C1H562JA01#	
	4700pF		±5%	GRM2162C2A472JA01#			6200pF		±5%	GRM2192C1H622JA01#	
	5600pF		±5%	GRM2192C2A562JA01#			6800pF		±5%	GRM2192C1H682JA01#	
	6800pF		±5%	GRM2192C2A682JA01#			7500pF		±5%	GRM2192C1H752JA01#	
	8200pF		±5%	GRM2192C2A822JA01#			8200pF		±5%	GRM2192C1H822JA01#	
	10000pF		±5%	GRM2192C2A103JA01#			9100pF		±5%	GRM2192C1H912JA01#	
	12000pF		±5%	GRM2192C2A123JA01#			10000pF		±5%	GRM2192C1H103JA01#	
	15000pF		±5%	GRM2192C2A153JA01#			11000pF		±5%	GRM2192C1H113JA01#	
18000pF	±5%		GRM21B2C2A183JA01#	12000pF	±5%	GRM2192C1H123JA01#					
22000pF	±5%	GRM21B2C2A223JA01#	13000pF	±5%	GRM2192C1H133JA01#						
50Vdc	COG	2400pF	±5%	GRM2165C1H242JA01#	15000pF	±5%	GRM2192C1H153JA01#				
		2700pF	±5%	GRM2165C1H272JA01#	18000pF	±5%	GRM21B2C1H183JA01#				
		3000pF	±5%	GRM2165C1H302JA01#	2000pF	±5%	GRM21B2C1H203JA01#				
		3300pF	±5%	GRM2165C1H332JA01#	2200pF	±5%	GRM21B2C1H223JA01#				
		3600pF	±5%	GRM2165C1H362JA01#	SL	3900pF	±5%	GRM21B1X1H393JA01#			
		3900pF	±5%	GRM2165C1H392JA01#		4300pF	±5%	GRM21B1X1H433JA01#			
		±5%	GRM2195C1H392JA01#	4700pF		±5%	GRM21B1X1H473JA01#				
		4300pF	±5%	GRM2165C1H432JA01#		U2J	3900pF	±5%	GRM21B7U1H393JA01#		
		±5%	GRM2195C1H432JA01#	4300pF			±5%	GRM21B7U1H433JA01#			
		4700pF	±5%	GRM2165C1H472JA01#			4700pF	±5%	GRM21B7U1H473JA01#		
		±5%	GRM2195C1H472JA01#	UJ	3900pF	±5%	GRM21B3U1H393JA01#				
		5100pF	±5%		GRM2195C1H512JA01#	4300pF	±5%	GRM21B3U1H433JA01#			
		5600pF	±5%		GRM2195C1H562JA01#	4700pF	±5%	GRM21B3U1H473JA01#			
		6200pF	±5%		GRM2195C1H622JA01#	10Vdc	SL	3300pF	±5%	GRM2161X1A333JA01#	
		6800pF	±5%		GRM2195C1H682JA01#			3900pF	±5%	GRM2191X1A393JA01#	
		7500pF	±5%		GRM2195C1H752JA01#			4700pF	±5%	GRM2191X1A473JA01#	
		8200pF	±5%	GRM2195C1H822JA01#	5600pF			±5%	GRM2191X1A563JA01#		
		9100pF	±5%	GRM2195C1H912JA01#							
		10000pF	±5%	GRM2195C1H103JA01#							

GRM
 GR3
 GRJ
 GR4
 GJM
 GQM
 GA2
 GA3 GB
 GA3 GD
 GA3 GF
 LLL
 LLA
 LLM
 LLR
 NFM
 GJ4
 ZRA
 ZRB
 KRM
 KR3
 GMA
 GMD
 △Caution / Notice

Part number # indicates the package specification code.

GRM Series Temperature Compensating Type Part Number List

(→ 2.0×1.25mm)

Rated Voltage	TC Code	Cap.	Tol.	Part Number
10Vdc	SL	6800pF	±5%	GRM21B1X1A683JA01#
		8200pF	±5%	GRM21B1X1A823JA01#
		0.10μF	±5%	GRM21B1X1A104JA01#
	U2J	33000pF	±5%	GRM2167U1A333JA01#
		39000pF	±5%	GRM2197U1A393JA01#
		47000pF	±5%	GRM2197U1A473JA01#
		56000pF	±5%	GRM2197U1A563JA01#
		68000pF	±5%	GRM21B7U1A683JA01#
		82000pF	±5%	GRM21B7U1A823JA01#
		0.10μF	±5%	GRM21B7U1A104JA01#
		UJ	33000pF	±5%
	39000pF		±5%	GRM2193U1A393JA01#
	47000pF		±5%	GRM2193U1A473JA01#
	56000pF		±5%	GRM2193U1A563JA01#
	68000pF		±5%	GRM21B3U1A683JA01#
	82000pF		±5%	GRM21B3U1A823JA01#
	0.10μF		±5%	GRM21B3U1A104JA01#

3.2×1.6mm

Rated Voltage	TC Code	Cap.	Tol.	Part Number		
2000Vdc	U2J	10pF	±5%	GRM31A7U3D100JW31#		
		12pF	±5%	GRM31A7U3D120JW31#		
		15pF	±5%	GRM31A7U3D150JW31#		
		18pF	±5%	GRM31A7U3D180JW31#		
		22pF	±5%	GRM31A7U3D220JW31#		
		27pF	±5%	GRM31A7U3D270JW31#		
		33pF	±5%	GRM31A7U3D330JW31#		
		39pF	±5%	GRM31A7U3D390JW31#		
		47pF	±5%	GRM31A7U3D470JW31#		
		56pF	±5%	GRM31A7U3D560JW31#		
		68pF	±5%	GRM31A7U3D680JW31#		
		1000Vdc	COG	10pF	±1%	GRM31A5C3A100FW01#
					±2%	GRM31A5C3A100GW01#
±5%	GRM31A5C3A100JW01#					
12pF	±1%			GRM31A5C3A120FW01#		
	±2%			GRM31A5C3A120GW01#		
	±5%			GRM31A5C3A120JW01#		
15pF	±1%			GRM31A5C3A150FW01#		
	±2%			GRM31A5C3A150GW01#		
	±5%			GRM31A5C3A150JW01#		
18pF	±1%			GRM31A5C3A180FW01#		
	±2%			GRM31A5C3A180GW01#		
	±5%			GRM31A5C3A180JW01#		
22pF	±1%			GRM31A5C3A220FW01#		
	±2%			GRM31A5C3A220GW01#		
	±5%			GRM31A5C3A220JW01#		
27pF	±1%			GRM31A5C3A270FW01#		
	±2%			GRM31A5C3A270GW01#		
	±5%			GRM31A5C3A270JW01#		
33pF	±1%			GRM31A5C3A330FW01#		
	±2%			GRM31A5C3A330GW01#		
	±5%			GRM31A5C3A330JW01#		

Rated Voltage	TC Code	Cap.	Tol.	Part Number
1000Vdc	COG	39pF	±1%	GRM31A5C3A390FW01#
			±2%	GRM31A5C3A390GW01#
			±5%	GRM31A5C3A390JW01#
		47pF	±1%	GRM31A5C3A470FW01#
			±2%	GRM31A5C3A470GW01#
			±5%	GRM31A5C3A470JW01#
		56pF	±1%	GRM31A5C3A560FW01#
			±2%	GRM31A5C3A560GW01#
			±5%	GRM31A5C3A560JW01#
		68pF	±1%	GRM31A5C3A680FW01#
			±2%	GRM31A5C3A680GW01#
			±5%	GRM31A5C3A680JW01#
		82pF	±1%	GRM31A5C3A820FW01#
			±2%	GRM31A5C3A820GW01#
			±5%	GRM31A5C3A820JW01#
		100pF	±1%	GRM31A5C3A101FW01#
			±2%	GRM31A5C3A101GW01#
			±5%	GRM31A5C3A101JW01#
		120pF	±1%	GRM31A5C3A121FW01#
			±2%	GRM31A5C3A121GW01#
			±5%	GRM31A5C3A121JW01#
		150pF	±1%	GRM31A5C3A151FW01#
			±2%	GRM31A5C3A151GW01#
			±5%	GRM31A5C3A151JW01#
		180pF	±1%	GRM31A5C3A181FW01#
			±2%	GRM31A5C3A181GW01#
			±5%	GRM31A5C3A181JW01#
		220pF	±1%	GRM31A5C3A221FW01#
			±2%	GRM31A5C3A221GW01#
			±5%	GRM31A5C3A221JW01#
		270pF	±1%	GRM31A5C3A271FWA1#
			±2%	GRM31A5C3A271GWA1#
			±5%	GRM31A5C3A271JWA1#
		330pF	±1%	GRM31A5C3A331FWA1#
			±2%	GRM31A5C3A331GWA1#
			±5%	GRM31A5C3A331JWA1#
		390pF	±1%	GRM31A5C3A391FWA1#
			±2%	GRM31A5C3A391GWA1#
			±5%	GRM31A5C3A391JWA1#
		470pF	±1%	GRM31A5C3A471FWA1#
			±2%	GRM31A5C3A471GWA1#
			±5%	GRM31A5C3A471JWA1#
		560pF	±1%	GRM31B5C3A561FWA1#
			±2%	GRM31B5C3A561GWA1#
			±5%	GRM31B5C3A561JWA1#
		680pF	±1%	GRM31B5C3A681FWA1#
			±2%	GRM31B5C3A681GWA1#
			±5%	GRM31B5C3A681JWA1#
		820pF	±1%	GRM31C5C3A821FWA3#
			±2%	GRM31C5C3A821GWA3#
			±5%	GRM31C5C3A821JWA3#
		1000pF	±1%	GRM31C5C3A102FWA3#
			±2%	GRM31C5C3A102GWA3#
			±5%	GRM31C5C3A102JWA3#

Part number # indicates the package specification code.



GRM Series Temperature Compensating Type Part Number List

(→ 3.2×1.6mm)

Rated Voltage	TC Code	Cap.	Tol.	Part Number	Rated Voltage	TC Code	Cap.	Tol.	Part Number		
1000Vdc	U2J	10pF	±5%	GRM31A7U3A100JW31#	630Vdc	COG	56pF	±5%	GRM31A5C2J560JW01#		
		12pF	±5%	GRM31A7U3A120JW31#			68pF	±1%	GRM31A5C2J680FW01#		
		15pF	±5%	GRM31A7U3A150JW31#				±2%	GRM31A5C2J680GW01#		
		18pF	±5%	GRM31A7U3A180JW31#				±5%	GRM31A5C2J680JW01#		
		22pF	±5%	GRM31A7U3A220JW31#			82pF	±1%	GRM31A5C2J820FW01#		
		27pF	±5%	GRM31A7U3A270JW31#				±2%	GRM31A5C2J820GW01#		
		33pF	±5%	GRM31A7U3A330JW31#				±5%	GRM31A5C2J820JW01#		
		39pF	±5%	GRM31A7U3A390JW31#			100pF	±1%	GRM31A5C2J101FW01#		
		47pF	±5%	GRM31A7U3A470JW31#				±2%	GRM31A5C2J101GW01#		
		56pF	±5%	GRM31A7U3A560JW31#				±5%	GRM31A5C2J101JW01#		
		68pF	±5%	GRM31A7U3A680JW31#			120pF	±1%	GRM31A5C2J121FW01#		
		82pF	±5%	GRM31A7U3A820JW31#				±2%	GRM31A5C2J121GW01#		
		100pF	±5%	GRM31A7U3A101JW31#				±5%	GRM31A5C2J121JW01#		
		120pF	±5%	GRM31A7U3A121JW31#			150pF	±1%	GRM31A5C2J151FW01#		
		150pF	±5%	GRM31A7U3A151JW31#				±2%	GRM31A5C2J151GW01#		
		180pF	±5%	GRM31A7U3A181JW31#				±5%	GRM31A5C2J151JW01#		
		220pF	±5%	GRM31A7U3A221JW31#			180pF	±1%	GRM31A5C2J181FW01#		
		270pF	±5%	GRM31A7U3A271JW31#				±2%	GRM31A5C2J181GW01#		
		330pF	±5%	GRM31A7U3A331JW31#				±5%	GRM31A5C2J181JW01#		
		390pF	±5%	GRM31B7U3A391JW31#			220pF	±1%	GRM31A5C2J221FW01#		
		470pF	±5%	GRM31B7U3A471JW31#				±2%	GRM31A5C2J221GW01#		
		560pF	±5%	GRM31B7U3A561JW31#				±5%	GRM31A5C2J221JW01#		
		680pF	±5%	GRM31B7U3A681JW31#			270pF	±1%	GRM31A5C2J271FW01#		
		820pF	±5%	GRM31C7U3A821JW32#				±2%	GRM31A5C2J271GW01#		
		1000pF	±5%	GRM31C7U3A102JW32#				±5%	GRM31A5C2J271JW01#		
		630Vdc	COG	10pF			±1%	GRM31A5C2J100FW01#	330pF	±1%	GRM31A5C2J331FW01#
							±2%	GRM31A5C2J100GW01#		±2%	GRM31A5C2J331GW01#
							±5%	GRM31A5C2J100JW01#		±5%	GRM31A5C2J331JW01#
12pF	±1%			GRM31A5C2J120FW01#	390pF	±1%	GRM31A5C2J391FW01#				
	±2%			GRM31A5C2J120GW01#		±2%	GRM31A5C2J391GW01#				
	±5%			GRM31A5C2J120JW01#		±5%	GRM31A5C2J391JW01#				
15pF	±1%			GRM31A5C2J150FW01#	470pF	±1%	GRM31A5C2J471FW01#				
	±2%			GRM31A5C2J150GW01#		±2%	GRM31A5C2J471GW01#				
	±5%			GRM31A5C2J150JW01#		±5%	GRM31A5C2J471JW01#				
18pF	±1%			GRM31A5C2J180FW01#	560pF	±1%	GRM31A5C2J561FW01#				
	±2%			GRM31A5C2J180GW01#		±2%	GRM31A5C2J561GW01#				
	±5%			GRM31A5C2J180JW01#		±5%	GRM31A5C2J561JW01#				
22pF	±1%			GRM31A5C2J220FW01#	680pF	±1%	GRM31B5C2J681FW01#				
	±2%			GRM31A5C2J220GW01#		±2%	GRM31B5C2J681GW01#				
	±5%			GRM31A5C2J220JW01#		±5%	GRM31B5C2J681JW01#				
27pF	±1%			GRM31A5C2J270FW01#	820pF	±1%	GRM31B5C2J821FW01#				
	±2%			GRM31A5C2J270GW01#		±2%	GRM31B5C2J821GW01#				
	±5%			GRM31A5C2J270JW01#		±5%	GRM31B5C2J821JW01#				
33pF	±1%			GRM31A5C2J330FW01#	1000pF	±1%	GRM31B5C2J102FW01#				
	±2%			GRM31A5C2J330GW01#		±2%	GRM31B5C2J102GW01#				
	±5%			GRM31A5C2J330JW01#		±5%	GRM31B5C2J102JW01#				
39pF	±1%			GRM31A5C2J390FW01#	1200pF	±1%	GRM31A5C2J122FWA1#				
	±2%			GRM31A5C2J390GW01#		±2%	GRM31A5C2J122GWA1#				
	±5%			GRM31A5C2J390JW01#		±5%	GRM31A5C2J122JWA1#				
47pF	±1%			GRM31A5C2J470FW01#	1500pF	±1%	GRM31A5C2J152FWA1#				
	±2%			GRM31A5C2J470GW01#		±2%	GRM31A5C2J152GWA1#				
	±5%			GRM31A5C2J470JW01#		±5%	GRM31A5C2J152JWA1#				
56pF	±1%			GRM31A5C2J560FW01#	1800pF	±1%	GRM31A5C2J182FWA1#				
	±2%			GRM31A5C2J560GW01#		±2%	GRM31A5C2J182GWA1#				

Part number # indicates the package specification code.

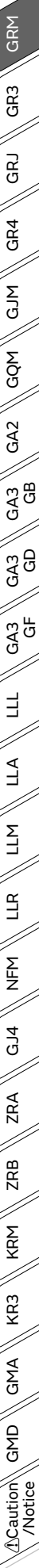

GRM Series Temperature Compensating Type Part Number List

(→ 3.2×1.6mm)

Rated Voltage	TC Code	Cap.	Tol.	Part Number	Rated Voltage	TC Code	Cap.	Tol.	Part Number																					
630Vdc	COG	1800pF	±5%	GRM31A5C2J182JWA1#	630Vdc	U2J	1500pF	±5%	GRM31A7U2J152JW31#																					
			±1%	GRM31B5C2J222FWA1#				1800pF	±5%	GRM31A7U2J182JW31#																				
			±2%	GRM31B5C2J222GWA1#					2200pF	±5%	GRM31A7U2J222JW31#																			
			±5%	GRM31B5C2J222JWA1#						2700pF	±5%	GRM31B7U2J272JW31#																		
		±1%	GRM31B5C2J272FWA1#	3300pF			±5%		GRM31B7U2J332JW31#																					
			±2%				GRM31B5C2J272GWA1#	3900pF	±5%		GRM31C7U2J392JW32#																			
			±5%				GRM31B5C2J272JWA1#		4700pF		±5%	GRM31C7U2J472JW32#																		
		±1%	GRM31C5C2J332FWA3#	10pF			±1%	GRM31A5C2H100FW01#																						
			±2%				GRM31C5C2J332GWA3#	±2%		GRM31A5C2H100GW01#																				
			±5%				GRM31C5C2J332JWA3#		12pF	±1%	GRM31A5C2H120FW01#																			
		±1%	GRM31C5C2J392FWA3#	12pF			±1%	GRM31A5C2H120GW01#																						
			±2%					GRM31C5C2J392GWA3#		±2%	GRM31A5C2H120JW01#																			
			±5%					GRM31C5C2J392JWA3#	15pF		±1%	GRM31A5C2H150FW01#																		
		±1%	GRM31C5C2J472FWA3#	15pF			±1%	GRM31A5C2H150GW01#																						
			±2%					GRM31C5C2J472GWA3#		±2%	GRM31A5C2H150JW01#																			
			±5%					GRM31C5C2J472JWA3#	18pF		±1%	GRM31A5C2H180FW01#																		
		±1%	GRM31C5C2J562FWA3#	18pF		±1%	GRM31A5C2H180GW01#																							
			±2%				GRM31C5C2J562GWA3#	±2%		GRM31A5C2H180JW01#																				
			±5%				GRM31C5C2J562JWA3#		22pF	±1%	GRM31A5C2H220FW01#																			
		±1%	GRM31C5C2J682FWA3#	22pF		±1%	GRM31A5C2H220GW01#																							
			±2%				GRM31C5C2J682GWA3#	±2%		GRM31A5C2H220JW01#																				
			±5%				GRM31C5C2J682JWA3#		27pF	±1%	GRM31A5C2H270FW01#																			
		±1%	GRM31C5C2J822FWA3#	27pF		±1%	GRM31A5C2H270GW01#																							
			±2%				GRM31C5C2J822GWA3#	±2%		GRM31A5C2H270JW01#																				
			±5%				GRM31C5C2J822JWA3#		33pF	±1%	GRM31A5C2H330FW01#																			
		±1%	GRM31C5C2J103FWA3#	33pF		±1%	GRM31A5C2H330GW01#																							
			±2%				GRM31C5C2J103GWA3#	±2%		GRM31A5C2H330JW01#																				
			±5%				GRM31C5C2J103JWA3#		39pF	±1%	GRM31A5C2H390FW01#																			
		±5%	GRM31A7U2J100JW31#	39pF		±1%	GRM31A5C2H390GW01#																							
			±5%				GRM31A7U2J120JW31#	±2%		GRM31A5C2H390JW01#																				
			±5%				GRM31A7U2J150JW31#		47pF	±1%	GRM31A5C2H470FW01#																			
		±5%	GRM31A7U2J180JW31#	47pF		±1%	GRM31A5C2H470GW01#																							
		±5%	GRM31A7U2J220JW31#				±2%	GRM31A5C2H470JW01#																						
		±5%	GRM31A7U2J270JW31#					56pF	±1%	GRM31A5C2H560FW01#																				
		±5%	GRM31A7U2J330JW31#	56pF		±1%	GRM31A5C2H560GW01#																							
		±5%	GRM31A7U2J390JW31#				±2%		GRM31A5C2H560JW01#																					
		±5%	GRM31A7U2J470JW31#					68pF	±1%	GRM31A5C2H680FW01#																				
		±5%	GRM31A7U2J560JW31#	68pF		±1%	GRM31A5C2H680GW01#																							
		±5%	GRM31A7U2J680JW31#				±2%		GRM31A5C2H680JW01#																					
		±5%	GRM31A7U2J820JW31#					82pF	±1%	GRM31A5C2H820FW01#																				
		±5%	GRM31A7U2J101JW31#	82pF		±1%	GRM31A5C2H820GW01#																							
		±5%	GRM31A7U2J121JW31#				±2%		GRM31A5C2H820JW01#																					
		±5%	GRM31A7U2J151JW31#					100pF	±1%	GRM31A5C2H101FW01#																				
		±5%	GRM31A7U2J181JW31#	100pF		±1%	GRM31A5C2H101GW01#																							
		±5%	GRM31A7U2J221JW31#				±2%		GRM31A5C2H101JW01#																					
		±5%	GRM31A7U2J271JW31#					120pF	±1%	GRM31A5C2H121FW01#																				
		±5%	GRM31A7U2J331JW31#	120pF		±1%	GRM31A5C2H121GW01#																							
		±5%	GRM31A7U2J391JW31#				±2%		GRM31A5C2H121JW01#																					
	±5%	GRM31A7U2J471JW31#	150pF		±1%			GRM31A5C2H151FW01#																						
	±5%	GRM31A7U2J561JW31#		150pF	±1%	GRM31A5C2H151GW01#																								
±5%	GRM31A7U2J681JW31#	±2%				GRM31A5C2H151JW01#																								
±5%	GRM31A7U2J821JW31#		180pF			±1%	GRM31A5C2H181FW01#																							
±5%	GRM31A7U2J102JW31#	180pF		±1%	GRM31A5C2H181GW01#																									
±5%	GRM31A7U2J122JW31#				±2%																									
630Vdc	U2J	10pF	±5%	GRM31A7U2J100JW31#	630Vdc	COG	10pF	±1%	GRM31A5C2H100FW01#																					
			±5%	GRM31A7U2J120JW31#				±1%	GRM31A5C2H100GW01#																					
			±5%	GRM31A7U2J150JW31#					±1%	GRM31A5C2H100JW01#																				
			±5%	GRM31A7U2J180JW31#						±1%	GRM31A5C2H120FW01#																			
			±5%	GRM31A7U2J220JW31#							±1%	GRM31A5C2H120GW01#																		
			±5%	GRM31A7U2J270JW31#								±1%	GRM31A5C2H120JW01#																	
			±5%	GRM31A7U2J330JW31#									±1%	GRM31A5C2H150FW01#																
			±5%	GRM31A7U2J390JW31#										±1%	GRM31A5C2H150GW01#															
			±5%	GRM31A7U2J470JW31#											±1%	GRM31A5C2H150JW01#														
			±5%	GRM31A7U2J560JW31#												±1%	GRM31A5C2H180FW01#													
			±5%	GRM31A7U2J680JW31#													±1%	GRM31A5C2H180GW01#												
			±5%	GRM31A7U2J820JW31#														±1%	GRM31A5C2H180JW01#											
			±5%	GRM31A7U2J101JW31#															±1%	GRM31A5C2H220FW01#										
			±5%	GRM31A7U2J121JW31#																±1%	GRM31A5C2H220GW01#									
			±5%	GRM31A7U2J151JW31#																	±1%	GRM31A5C2H220JW01#								
			±5%	GRM31A7U2J181JW31#																		±1%	GRM31A5C2H270FW01#							
			±5%	GRM31A7U2J221JW31#																			±1%	GRM31A5C2H270GW01#						
			±5%	GRM31A7U2J271JW31#																				±1%	GRM31A5C2H270JW01#					
			±5%	GRM31A7U2J331JW31#																					±1%	GRM31A5C2H330FW01#				
			±5%	GRM31A7U2J391JW31#																						±1%	GRM31A5C2H330GW01#			
			±5%	GRM31A7U2J471JW31#																							±1%	GRM31A5C2H330JW01#		
			±5%	GRM31A7U2J561JW31#																								±1%	GRM31A5C2H390FW01#	
			±5%	GRM31A7U2J681JW31#																									±1%	GRM31A5C2H390GW01#
			±5%	GRM31A7U2J821JW31#																										±1%
±5%	GRM31A7U2J102JW31#	±1%	GRM31A5C2H470FW01#																											
±5%	GRM31A7U2J122JW31#		±1%	GRM31A5C2H470GW01#																										

- GRM
- GR3
- GRJ
- GR4
- GJM
- GQM
- GA2
- GA3 GB
- GA3 GD
- GA3 GF
- LLL
- LLA
- LLM
- LLR
- NFM
- GJ4
- ZRA
- ZRB
- KRM
- KR3
- GMA
- GMD
- ⚠Caution /Notice

Part number # indicates the package specification code.

GRM Series Temperature Compensating Type Part Number List

(→ 3.2×1.6mm)

Rated Voltage	TC Code	Cap.	Tol.	Part Number	Rated Voltage	TC Code	Cap.	Tol.	Part Number		
500Vdc	COG	180pF	±5%	GRM31A5C2H181JW01#	500Vdc	U2J	1500pF	±5%	GRM31A7U2H152JW31#		
			±1%	GRM31A5C2H221FW01#			1800pF	±5%	GRM31A7U2H182JW31#		
			±2%	GRM31A5C2H221GW01#			2200pF	±5%	GRM31A7U2H222JW31#		
			±5%	GRM31A5C2H221JW01#			2700pF	±5%	GRM31B7U2H272JW31#		
		270pF	±1%	GRM31A5C2H271FW01#			3300pF	±5%	GRM31B7U2H332JW31#		
			±2%	GRM31A5C2H271GW01#			3900pF	±5%	GRM31C7U2H392JW32#		
			±5%	GRM31A5C2H271JW01#			4700pF	±5%	GRM31C7U2H472JW32#		
		330pF	±1%	GRM31A5C2H331FW01#			250Vdc	COG	12000pF	±1%	GRM31B5C2E123FWA1#
			±2%	GRM31A5C2H331GW01#						±2%	GRM31B5C2E123GWA1#
			±5%	GRM31A5C2H331JW01#						±5%	GRM31B5C2E123JWA1#
		390pF	±1%	GRM31A5C2H391FW01#					15000pF	±1%	GRM31C5C2E153FWA3#
			±2%	GRM31A5C2H391GW01#						±2%	GRM31C5C2E153GWA3#
			±5%	GRM31A5C2H391JW01#						±5%	GRM31C5C2E153JWA3#
		470pF	±1%	GRM31A5C2H471FW01#					18000pF	±1%	GRM31C5C2E183FWA3#
			±2%	GRM31A5C2H471GW01#						±2%	GRM31C5C2E183GWA3#
			±5%	GRM31A5C2H471JW01#	±5%	GRM31C5C2E183JWA3#					
		560pF	±1%	GRM31A5C2H561FW01#	22000pF	±1%			GRM31C5C2E223FWA3#		
			±2%	GRM31A5C2H561GW01#		±2%			GRM31C5C2E223GWA3#		
			±5%	GRM31A5C2H561JW01#		±5%			GRM31C5C2E223JWA3#		
		680pF	±1%	GRM31B5C2H681FW01#	U2J	6800pF			±5%	GRM31B7U2E682JW31#	
			±2%	GRM31B5C2H681GW01#		8200pF			±5%	GRM31B7U2E822JW31#	
			±5%	GRM31B5C2H681JW01#		10000pF			±5%	GRM31B7U2E103JW31#	
		820pF	±1%	GRM31B5C2H821FW01#	200Vdc	U2J	6800pF	±5%	GRM31B7U2D682JW31#		
			±2%	GRM31B5C2H821GW01#			8200pF	±5%	GRM31B7U2D822JW31#		
			±5%	GRM31B5C2H821JW01#			10000pF	±5%	GRM31B7U2D103JW31#		
		1000pF	±1%	GRM31B5C2H102FW01#	100Vdc	COG	4300pF	±5%	GRM3195C2A432JA01#		
			±2%	GRM31B5C2H102GW01#			4700pF	±5%	GRM3195C2A472JA01#		
			±5%	GRM31B5C2H102JW01#			5100pF	±5%	GRM3195C2A512JA01#		
		10pF	±5%	GRM31A7U2H100JW31#			5600pF	±5%	GRM3195C2A562JA01#		
			±5%	GRM31A7U2H120JW31#			6800pF	±5%	GRM3195C2A682JA01#		
		15pF	±5%	GRM31A7U2H150JW31#			7500pF	±5%	GRM3195C2A752JA01#		
		18pF	±5%	GRM31A7U2H180JW31#			8200pF	±5%	GRM3195C2A822JA01#		
		22pF	±5%	GRM31A7U2H220JW31#			9100pF	±5%	GRM3195C2A912JA01#		
		27pF	±5%	GRM31A7U2H270JW31#			10000pF	±5%	GRM3195C2A103JA01#		
		33pF	±5%	GRM31A7U2H330JW31#			11000pF	±5%	GRM3195C2A113JA01#		
		39pF	±5%	GRM31A7U2H390JW31#			12000pF	±5%	GRM3195C2A123JA01#		
		47pF	±5%	GRM31A7U2H470JW31#			13000pF	±5%	GRM3195C2A133JA01#		
		56pF	±5%	GRM31A7U2H560JW31#			15000pF	±5%	GRM3195C2A153JA01#		
		68pF	±5%	GRM31A7U2H680JW31#			16000pF	±5%	GRM3195C2A163JA01#		
		82pF	±5%	GRM31A7U2H820JW31#			18000pF	±5%	GRM3195C2A183JA01#		
		100pF	±5%	GRM31A7U2H101JW31#	20000pF	±5%	GRM3195C2A203JA01#				
		120pF	±5%	GRM31A7U2H121JW31#	22000pF	±5%	GRM3195C2A223JA01#				
		150pF	±5%	GRM31A7U2H151JW31#	24000pF	±5%	GRM3195C2A243JA01#				
		180pF	±5%	GRM31A7U2H181JW31#	27000pF	±5%	GRM3195C2A273JA01#				
		220pF	±5%	GRM31A7U2H221JW31#	30000pF	±5%	GRM3195C2A303JA01#				
	270pF	±5%	GRM31A7U2H271JW31#	33000pF	±5%	GRM3195C2A333JA01#					
	330pF	±5%	GRM31A7U2H331JW31#	36000pF	±5%	GRM3195C2A363JA01#					
	390pF	±5%	GRM31A7U2H391JW31#	39000pF	±5%	GRM3195C2A393JA01#					
	470pF	±5%	GRM31A7U2H471JW31#	±5%	GRM31M5C2A393JA01#						
	560pF	±5%	GRM31A7U2H561JW31#	4300pF	±5%	GRM31M5C2A433JA01#					
680pF	±5%	GRM31A7U2H681JW31#	47000pF	±2%	GRM31M5C2A473GA01#						
820pF	±5%	GRM31A7U2H821JW31#	±5%	GRM31M5C2A473JA01#							
1000pF	±5%	GRM31A7U2H102JW31#	51000pF	±5%	GRM31M5C2A513JA01#						
1200pF	±5%	GRM31A7U2H122JW31#	56000pF	±5%	GRM31C5C2A563JA01#						

Part number # indicates the package specification code.

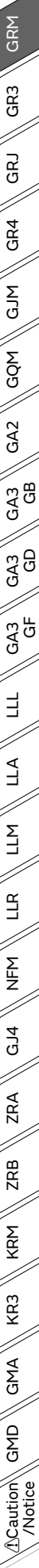

GRM Series Temperature Compensating Type Part Number List

(→ 3.2×1.6mm)

Rated Voltage	TC Code	Cap.	Tol.	Part Number		Rated Voltage	TC Code	Cap.	Tol.	Part Number		
100Vdc	COG	5600pF	±5%	GRM31M5C2A563JA01#	D1	50Vdc	COG	4700pF	±2%	GRM3195C1H473GA05#		
		6200pF	±5%	GRM31C5C2A623JA01#	D1				±5%	GRM3195C1H473JA05#		
		6800pF	±5%	GRM31C5C2A683JA01#	D1				±5%	GRM31M5C1H473JA01#		
		7500pF	±5%	GRM31C5C2A753JA01#	D1			5100pF	±5%	GRM31M5C1H513JA01#		
		8200pF	±2%	GRM31C5C2A823GA01#	D1			5600pF	±2%	GRM3195C1H563GA05#		
			±5%	GRM31C5C2A823JA01#	D1					±5%	GRM3195C1H563JA05#	
		9100pF	±5%	GRM31C5C2A913JA01#	D1					±5%	GRM31C5C1H563JA01#	
		0.10μF	±5%	GRM31C5C2A104JA01#	D1					±5%	GRM31M5C1H563JA01#	
		CH	5100pF	±5%	GRM3192C2A512JA01#				6200pF	±5%	GRM31C5C1H623JA01#	
	5600pF		±5%	GRM3192C2A562JA01#				6800pF	±2%	GRM3195C1H683GA05#		
	6800pF		±5%	GRM3192C2A682JA01#						±5%	GRM3195C1H683JA05#	
	7500pF		±5%	GRM3192C2A752JA01#					±5%	GRM31C5C1H683JA01#		
	8200pF		±5%	GRM3192C2A822JA01#				7500pF	±5%	GRM31C5C1H753JA01#		
	9100pF		±5%	GRM3192C2A912JA01#				8200pF	±2%	GRM3195C1H823GA05#		
	10000pF		±5%	GRM3192C2A103JA01#						±5%	GRM3195C1H823JA05#	
	11000pF		±5%	GRM3192C2A113JA01#					±5%	GRM31C5C1H823JA01#		
	12000pF		±5%	GRM3192C2A123JA01#				9100pF	±5%	GRM31C5C1H913JA01#		
	13000pF		±5%	GRM3192C2A133JA01#				0.10μF	±2%	GRM3195C1H104GA05#		
	15000pF		±5%	GRM3192C2A153JA01#						±5%	GRM3195C1H104JA05#	
	16000pF		±5%	GRM3192C2A163JA01#					±5%	GRM31C5C1H104JA01#		
	18000pF		±5%	GRM3192C2A183JA01#				0.15μF	±2%	GRM31C5C1H154GE02#	D1	
	20000pF		±5%	GRM3192C2A203JA01#						±5%	GRM31C5C1H154JE02#	D1
	22000pF		±5%	GRM3192C2A223JA01#				0.22μF	±2%	GRM31C5C1H224GE02#	D1	
	24000pF		±5%	GRM3192C2A243JA01#						±5%	GRM31C5C1H224JE02#	D1
	27000pF		±5%	GRM3192C2A273JA01#				CH	1100pF	±5%	GRM3192C1H113JA01#	
	30000pF		±5%	GRM3192C2A303JA01#					1200pF	±5%	GRM3192C1H123JA01#	
	33000pF		±5%	GRM3192C2A333JA01#					1300pF	±5%	GRM3192C1H133JA01#	
	36000pF		±5%	GRM3192C2A363JA01#	D1				1500pF	±5%	GRM3192C1H153JA01#	
	39000pF		±5%	GRM3192C2A393JA01#	D1				1600pF	±5%	GRM3192C1H163JA01#	
			±5%	GRM31M2C2A393JA01#					1800pF	±5%	GRM3192C1H183JA01#	
	43000pF		±5%	GRM31M2C2A433JA01#					2000pF	±5%	GRM3192C1H203JA01#	
	47000pF		±5%	GRM31M2C2A473JA01#					2200pF	±5%	GRM3192C1H223JA01#	
	51000pF		±5%	GRM31M2C2A513JA01#	D1				2700pF	±5%	GRM3192C1H273JA01#	
	56000pF		±5%	GRM31C2C2A563JA01#					3300pF	±5%	GRM3192C1H333JA01#	
			±5%	GRM31M2C2A563JA01#	D1				3900pF	±5%	GRM3192C1H393JA01#	
	62000pF		±5%	GRM31C2C2A623JA01#	D1					±5%	GRM31M2C1H393JA01#	
	68000pF		±5%	GRM31C2C2A683JA01#	D1				43000pF	±5%	GRM31M2C1H433JA01#	
	75000pF		±5%	GRM31C2C2A753JA01#	D1				47000pF	±5%	GRM31M2C1H473JA01#	
	82000pF		±5%	GRM31C2C2A823JA01#	D1				51000pF	±5%	GRM31M2C1H513JA01#	
	91000pF		±5%	GRM31C2C2A913JA01#	D1				5600pF	±5%	GRM31C2C1H563JA01#	
	0.10μF	±5%	GRM31C2C2A104JA01#	D1				±5%		GRM31M2C1H563JA01#		
	50Vdc	COG	1100pF	±5%	GRM3195C1H113JA01#				6200pF	±5%	GRM31C2C1H623JA01#	
			1200pF	±5%	GRM3195C1H123JA01#				6800pF	±5%	GRM31C2C1H683JA01#	
			1300pF	±5%	GRM3195C1H133JA01#				7500pF	±5%	GRM31C2C1H753JA01#	
			1500pF	±5%	GRM3195C1H153JA01#				8200pF	±5%	GRM31C2C1H823JA01#	
			1600pF	±5%	GRM3195C1H163JA01#				9100pF	±5%	GRM31C2C1H913JA01#	
			1800pF	±5%	GRM3195C1H183JA01#						±5%	GRM31C2C1H104JA01#
			2000pF	±5%	GRM3195C1H203JA01#				SL	6800pF	±5%	GRM31M1X1H683JA01#
			2200pF	±5%	GRM3195C1H223JA01#			7500pF		±5%	GRM31M1X1H753JA01#	
			2700pF	±5%	GRM3195C1H273JA01#			8200pF		±5%	GRM31M1X1H823JA01#	
3300pF			±5%	GRM3195C1H333JA01#		9100pF	±5%	GRM31M1X1H913JA01#				
3900pF			±5%	GRM3195C1H393JA01#			0.10μF	±5%	GRM31M1X1H104JA01#			
			±5%	GRM31M5C1H393JA01#		U2J	6800pF	±5%	GRM31M7U1H683JA01#			
4300pF			±5%	GRM31M5C1H433JA01#			7500pF	±5%	GRM31M7U1H753JA01#			

Part number # indicates the package specification code.

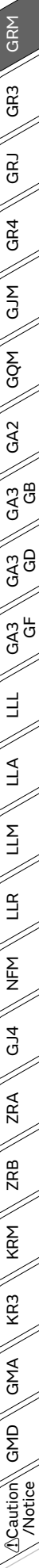

GRM Series Temperature Compensating Type Part Number List

(→ 3.2×1.6mm)

Rated Voltage	TC Code	Cap.	Tol.	Part Number
50Vdc	U2J	82000pF	±5%	GRM31M7U1H823JA01#
		91000pF	±5%	GRM31M7U1H913JA01#
		0.10μF	±5%	GRM31M7U1H104JA01#
	UJ	68000pF	±5%	GRM31M3U1H683JA01#
		75000pF	±5%	GRM31M3U1H753JA01#
		82000pF	±5%	GRM31M3U1H823JA01#
		91000pF	±5%	GRM31M3U1H913JA01#
		0.10μF	±5%	GRM31M3U1H104JA01#
		25Vdc	COG	0.15μF
±5%	GRM31C5C1E154JE02#			
0.22μF	±2%		GRM31C5C1E224GE02#	
	±5%		GRM31C5C1E224JE02#	

Rated Voltage	TC Code	Cap.	Tol.	Part Number
3150Vdc	U2J	12pF	±5%	GRM42A7U3F120JW31#
		15pF	±5%	GRM42A7U3F150JW31#
		18pF	±5%	GRM42A7U3F180JW31#
		22pF	±5%	GRM42A7U3F220JW31#
		27pF	±5%	GRM42A7U3F270JW31#
		33pF	±5%	GRM42A7U3F330JW31#
		39pF	±5%	GRM42A7U3F390JW31#
		47pF	±5%	GRM42A7U3F470JW31#
		56pF	±5%	GRM42A7U3F560JW31#
		68pF	±5%	GRM42A7U3F680JW31#
		82pF	±5%	GRM42A7U3F820JW31#
		100pF	±5%	GRM42A7U3F101JW31#

3.2×2.5mm

Rated Voltage	TC Code	Cap.	Tol.	Part Number		
2000Vdc	U2J	82pF	±5%	GRM32A7U3D820JW31#		
		100pF	±5%	GRM32A7U3D101JW31#		
		120pF	±5%	GRM32A7U3D121JW31#		
		150pF	±5%	GRM32A7U3D151JW31#		
		180pF	±5%	GRM32B7U3D181JW31#		
		220pF	±5%	GRM32B7U3D221JW31#		
1000Vdc	U2J	1200pF	±5%	GRM32B7U3A122JW31#		
		1500pF	±5%	GRM32Q7U3A152JW31#		
		1800pF	±5%	GRM32D7U3A182JW31#		
		2200pF	±5%	GRM32D7U3A222JW31#		
630Vdc	COG	33000pF	±1%	GRM32E5C2J333FWAA#		
			±2%	GRM32E5C2J333GWAA#		
			±5%	GRM32E5C2J333JWAA#		
	U2J	1200pF	±5%	GRM32A7U2J122JW31#		
		1500pF	±5%	GRM32A7U2J152JW31#		
		1800pF	±5%	GRM32A7U2J182JW31#		
		2200pF	±5%	GRM32A7U2J222JW31#		
		5600pF	±5%	GRM32B7U2J562JW31#		
		6800pF	±5%	GRM32Q7U2J682JW31#		
		8200pF	±5%	GRM32D7U2J822JW31#		
		10000pF	±5%	GRM32D7U2J103JW31#		
		12000pF	±5%	GRM32E7U2J123JW32#		
		15000pF	±5%	GRM32E7U2J153JW32#		
		500Vdc	U2J	1200pF	±5%	GRM32A7U2H122JW31#
				1500pF	±5%	GRM32A7U2H152JW31#
1800pF	±5%			GRM32A7U2H182JW31#		
2200pF	±5%			GRM32A7U2H222JW31#		
5600pF	±5%			GRM32B7U2H562JW31#		
6800pF	±5%			GRM32Q7U2H682JW31#		
8200pF	±5%			GRM32D7U2H822JW31#		
10000pF	±5%			GRM32D7U2H103JW31#		

4.5×3.2mm

Rated Voltage	TC Code	Cap.	Tol.	Part Number
1000Vdc	U2J	2700pF	±5%	GRM43Q7U3A272JW31#
		3300pF	±5%	GRM43Q7U3A332JW31#
		3900pF	±5%	GRM43D7U3A392JW31#
		4700pF	±5%	GRM43D7U3A472JW31#
630Vdc	U2J	12000pF	±5%	GRM43Q7U2J123JW31#
		15000pF	±5%	GRM43D7U2J153JW31#
		18000pF	±5%	GRM43D7U2J183JW31#
500Vdc	U2J	22000pF	±5%	GRM43D7U2J223JW31#
		12000pF	±5%	GRM43Q7U2H123JW31#
		15000pF	±5%	GRM43D7U2H153JW31#
		18000pF	±5%	GRM43D7U2H183JW31#
22000pF	±5%	GRM43D7U2H223JW31#		

5.7×5.0mm

Rated Voltage	TC Code	Cap.	Tol.	Part Number
1000Vdc	U2J	5600pF	±5%	GRM55Q7U3A562JW31#
		6800pF	±5%	GRM55Q7U3A682JW31#
		8200pF	±5%	GRM55D7U3A822JW31#
		10000pF	±5%	GRM55D7U3A103JW31#
630Vdc	U2J	27000pF	±5%	GRM55Q7U2J273JW31#
		33000pF	±5%	GRM55D7U2J333JW31#
		39000pF	±5%	GRM55D7U2J393JW31#
		47000pF	±5%	GRM55D7U2J473JW31#
500Vdc	U2J	27000pF	±5%	GRM55Q7U2H273JW31#
		33000pF	±5%	GRM55D7U2H333JW31#
		39000pF	±5%	GRM55D7U2H393JW31#
		47000pF	±5%	GRM55D7U2H473JW31#

4.5×2.0mm

Rated Voltage	TC Code	Cap.	Tol.	Part Number
3150Vdc	U2J	10pF	±5%	GRM42A7U3F100JW31#

Part number # indicates the package specification code.

GRM
 GR3
 GRJ
 GR4
 GJM
 GQM
 GA2
 GA3 GB
 GA3 GD
 GA3 GF
 LLL
 LLA
 LLM
 LLR
 NFM
 GJ4
 ZRA
 ZRB
 KRM
 KR3
 GMA
 GMD
 ⚠Caution /Notice

GRM Series High Dielectric Constant Type Part Number List

0.25×0.125mm

Rated Voltage	TC Code	Cap.	Tol.	Part Number	
10Vdc	X5R	100pF	±10%	GRM011R61A101KE01#	
			±20%	GRM011R61A101ME01#	
		150pF	±10%	GRM011R61A151KE01#	
			±20%	GRM011R61A151ME01#	
		220pF	±10%	GRM011R61A221KE01#	
			±20%	GRM011R61A221ME01#	
		330pF	±10%	GRM011R61A331KE01#	
			±20%	GRM011R61A331ME01#	
		470pF	±10%	GRM011R61A471KE01#	
			±20%	GRM011R61A471ME01#	
		680pF	±10%	GRM011R61A681KE01#	
			±20%	GRM011R61A681ME01#	
6.3Vdc	X5R	1000pF	±10%	GRM011R60J102KE01#	
			±20%	GRM011R60J102ME01#	
		1500pF	±10%	GRM011R60J152KE01#	
			±20%	GRM011R60J152ME01#	
		2200pF	±10%	GRM011R60J222KE01#	
			±20%	GRM011R60J222ME01#	
		3300pF	±10%	GRM011R60J332KE01#	D1
			±20%	GRM011R60J332ME01#	D1
		4700pF	±10%	GRM011R60J472KE01#	D1
			±20%	GRM011R60J472ME01#	D1
		6800pF	±10%	GRM011R60J682KE01#	D1
			±20%	GRM011R60J682ME01#	D1
10000pF	±10%	GRM011R60J103KE01#	D1		
	±20%	GRM011R60J103ME01#	D1		
4Vdc	X5R	3300pF	±10%	GRM011R60G332KE01#	
		4700pF	±10%	GRM011R60G472KE01#	
		6800pF	±10%	GRM011R60G682KE01#	
		10000pF	±10%	GRM011R60G103KE01#	

0.4×0.2mm

Rated Voltage	TC Code	Cap.	Tol.	Part Number	
16Vdc	X7R	56pF	±10%	GRM022R71C560KE14#	
			±20%	GRM022R71C560ME14#	
		68pF	±10%	GRM022R71C680KE14#	
			±20%	GRM022R71C680ME14#	
		82pF	±10%	GRM022R71C820KE14#	
			±20%	GRM022R71C820ME14#	
		100pF	±10%	GRM022R71C101KE14#	
			±20%	GRM022R71C101ME14#	
		120pF	±10%	GRM022R71C121KE14#	
			±20%	GRM022R71C121ME14#	
		150pF	±10%	GRM022R71C151KE14#	
			±20%	GRM022R71C151ME14#	
		180pF	±10%	GRM022R71C181KE14#	
			±20%	GRM022R71C181ME14#	
		220pF	±10%	GRM022R71C221KE14#	
			±20%	GRM022R71C221ME14#	
		270pF	±10%	GRM022R71C271KE14#	

Rated Voltage	TC Code	Cap.	Tol.	Part Number	
16Vdc	X7R	270pF	±20%	GRM022R71C271ME14#	
		330pF	±10%	GRM022R71C331KE14#	
			±20%	GRM022R71C331ME14#	
		390pF	±10%	GRM022R71C391KE14#	
			±20%	GRM022R71C391ME14#	
		470pF	±10%	GRM022R71C471KE14#	
			±20%	GRM022R71C471ME14#	
		560pF	±10%	GRM022R71C561KE14#	
			±20%	GRM022R71C561ME14#	
		680pF	±10%	GRM022R71C681KE14#	
			±20%	GRM022R71C681ME14#	
		820pF	±10%	GRM022R71C821KE14#	
	±20%		GRM022R71C821ME14#		
	1000pF	±10%	GRM022R71C102KE14#		
		±20%	GRM022R71C102ME14#		
	X5R	680pF	±10%	GRM022R61C681KE01#	D1
			±20%	GRM022R61C681ME01#	D1
		1000pF	±10%	GRM022R61C102KE01#	D1
			±20%	GRM022R61C102ME01#	D1
		1500pF	±10%	GRM022R61C152KE01#	D1
			±20%	GRM022R61C152ME01#	D1
		2200pF	±10%	GRM022R61C222KE01#	D1
			±20%	GRM022R61C222ME01#	D1
		3300pF	±10%	GRM022R61C332KE01#	D1
±20%			GRM022R61C332ME01#	D1	
4700pF		±10%	GRM022R61C472KE01#	D1	
		±20%	GRM022R61C472ME01#	D1	
6800pF	±10%	GRM022R61C682KE01#	D1		
	±20%	GRM022R61C682ME01#	D1		
10000pF	±10%	GRM022R61C103KE01#	D1		
	±20%	GRM022R61C103ME01#	D1		
10Vdc	X7R	56pF	±10%	GRM022R71A560KA01#	
			±20%	GRM022R71A560MA01#	
		68pF	±10%	GRM022R71A680KA01#	
			±20%	GRM022R71A680MA01#	
		82pF	±10%	GRM022R71A820KA01#	
			±20%	GRM022R71A820MA01#	
		100pF	±10%	GRM022R71A101KA01#	
			±20%	GRM022R71A101MA01#	
		120pF	±10%	GRM022R71A121KA01#	
			±20%	GRM022R71A121MA01#	
		150pF	±10%	GRM022R71A151KA01#	
			±20%	GRM022R71A151MA01#	
	180pF	±10%	GRM022R71A181KA01#		
		±20%	GRM022R71A181MA01#		
	220pF	±10%	GRM022R71A221KA01#		
		±20%	GRM022R71A221MA01#		
	270pF	±10%	GRM022R71A271KA01#		
		±20%	GRM022R71A271MA01#		
	330pF	±10%	GRM022R71A331KA01#		
		±20%	GRM022R71A331MA01#		
	390pF	±10%	GRM022R71A391KA01#		
		±20%	GRM022R71A391MA01#		
	470pF	±10%	GRM022R71A471KA01#		

Part number # indicates the package specification code.

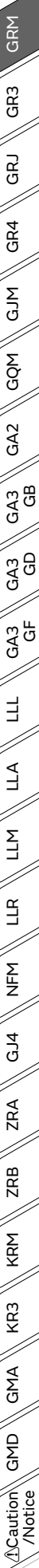

GRM Series High Dielectric Constant Type Part Number List

(→ 0.4×0.2mm)

Rated Voltage	TC Code	Cap.	Tol.	Part Number	Rated Voltage	TC Code	Cap.	Tol.	Part Number	
10Vdc	X7R	470pF	±20%	GRM022R71A471MA01#	10Vdc	X5R	2700pF	±10%	GRM022R61A272KE19#	
		560pF	±10%	GRM022R71A561KA01#				±20%	GRM022R61A272ME19#	
			680pF	±20%			GRM022R71A561MA01#	3300pF	±5%	GRM022R61A332JE19#
		±10%		GRM022R71A681KA12#			±10%		GRM022R61A332KE19#	
		820pF	±20%	GRM022R71A681MA12#			3900pF	±20%	GRM022R61A332ME19#	
			±10%	GRM022R71A821KA12#				±5%	GRM022R61A392JE19#	
		1000pF	±20%	GRM022R71A821MA12#			4700pF	±10%	GRM022R61A392KE19#	
			±10%	GRM022R71A102KA12#				±20%	GRM022R61A392ME19#	
		56pF	±10%	GRM022R61A560KA01#			5600pF	±5%	GRM022R61A472JE19#	
				±20%					GRM022R61A560MA01#	±10%
		68pF	±10%	GRM022R61A680KA01#			±10%	GRM022R61A472ME19#	±20%	GRM022R61A472ME19#
				±20%				GRM022R61A680MA01#		6800pF
		82pF	±10%	GRM022R61A820KA01#			±10%	GRM022R61A562KE19#	±20%	
				±20%				GRM022R61A820MA01#		8200pF
		100pF	±10%	GRM022R61A101KA01#			±10%	GRM022R61A682KE19#	±20%	
				±20%				GRM022R61A101MA01#		8200pF
		120pF	±10%	GRM022R61A121KA01#			±10%	GRM022R61A822KE19#	±20%	
				±20%				GRM022R61A121MA01#		10000pF
	150pF	±10%	GRM022R61A151KA01#	±10%		GRM022R61A151MA01#	±20%	GRM022R61A103KE19#		
			±20%			GRM022R61A151MA01#		0.10μF	±10%	GRM022R61A104KE01#
	180pF	±10%	GRM022R61A181KA01#	±10%		GRM022R61A181MA01#	±20%		GRM022R61A104ME01#	
			±20%			GRM022R61A181MA01#		B	56pF	±10%
	220pF	±10%	GRM022R61A221KA01#	±20%		GRM022B11A560MA01#	±20%			GRM022B11A560MA01#
			±20%			GRM022R61A221MA01#		68pF	±10%	GRM022B11A680KA01#
	270pF	±10%	GRM022R61A271KA01#	±10%		GRM022B11A680MA01#	±20%		GRM022B11A680MA01#	
			±20%			GRM022R61A271MA01#		82pF	±10%	GRM022B11A820KA01#
	330pF	±10%	GRM022R61A331KA01#	±10%		GRM022B11A820MA01#	±20%		GRM022B11A820MA01#	
			±20%			GRM022R61A331MA01#		100pF	±10%	GRM022B11A101KA01#
	390pF	±10%	GRM022R61A391KA01#	±10%		GRM022B11A101MA01#	±20%		GRM022B11A101MA01#	
			±20%			GRM022R61A391MA01#		120pF	±10%	GRM022B11A121KA01#
	470pF	±10%	GRM022R61A471KA01#	±10%		GRM022B11A121MA01#	±20%		GRM022B11A121MA01#	
			±20%			GRM022R61A471MA01#		150pF	±10%	GRM022B11A151KA01#
	560pF	±10%	GRM022R61A561KA01#	±10%		GRM022B11A151MA01#	±20%		GRM022B11A151MA01#	
			±20%			GRM022R61A561MA01#		180pF	±10%	GRM022B11A181KA01#
	680pF	±10%	GRM022R61A681KE19#	±10%		GRM022B11A181MA01#	±20%		GRM022B11A181MA01#	
			±20%			GRM022R61A681ME19#		220pF	±10%	GRM022B11A221KA01#
	820pF	±10%	GRM022R61A821KE19#	±10%		GRM022B11A221MA01#	±20%		GRM022B11A221MA01#	
			±20%			GRM022R61A821ME19#		270pF	±10%	GRM022B11A271KA01#
	1000pF	±10%	GRM022R61A102KE19#	±10%		GRM022B11A271MA01#	±20%		GRM022B11A271MA01#	
			±20%			GRM022R61A102ME19#		330pF	±10%	GRM022B11A331KA01#
	1200pF	±5%	GRM022R61A122JE19#	±10%		GRM022B11A331MA01#	±20%		GRM022B11A331MA01#	
			±10%			GRM022R61A122KE19#		390pF	±10%	GRM022B11A391KA01#
	1500pF	±20%	GRM022R61A122ME19#	±10%		GRM022B11A391MA01#	±20%		GRM022B11A391MA01#	
			±5%			GRM022R61A152JE19#		470pF	±10%	GRM022B11A471KA01#
	1800pF	±10%	GRM022R61A152KE19#	±10%		GRM022B11A471MA01#	±20%		GRM022B11A471MA01#	
			±20%			GRM022R61A152ME19#		560pF	±10%	GRM022B11A561KA01#
2200pF	±5%	GRM022R61A182JE19#	±10%	GRM022B11A561MA01#	±20%	GRM022B11A561MA01#				
		±10%		GRM022R61A182KE19#		680pF	±5%	GRM022B31A681JE19#		
2700pF	±20%	GRM022R61A182ME19#	±10%	GRM022B31A681KA12#	±10%		GRM022B31A681KE19#			
		±5%		GRM022R61A222JE19#		±10%	GRM022B31A681KE19#			
2700pF	±5%	GRM022R61A222KE19#	±10%	GRM022B31A681KE19#	±10%	GRM022B31A681KE19#				
		±20%		GRM022R61A222ME19#		±10%	GRM022B31A681KE19#			

- GRM
- GR3
- GRJ
- GR4
- GJM
- GQM
- GA2
- GA3 GB
- GA3 GD
- GA3 GF
- LLL
- LLA
- LLM
- LLR
- NFM
- GJ4
- ZRA
- ZRB
- KRM
- KR3
- GMA
- GMD
- ⚠Caution /Notice

Part number # indicates the package specification code.

GRM Series High Dielectric Constant Type Part Number List

(→ 0.4×0.2mm)

Rated Voltage	TC Code	Cap.	Tol.	Part Number	Rated Voltage	TC Code	Cap.	Tol.	Part Number			
10Vdc	B	680pF	±20%	GRM022B11A681MA12#	6.3Vdc	X5R	1000pF	±5%	GRM022R60J102JE19#			
			±20%	GRM022B31A681ME19#				±10%	GRM022R60J102KE19#			
		820pF	±5%	GRM022B31A821JE19#				±20%	GRM022R60J102ME19#			
			±10%	GRM022B11A821KA12#			1200pF	±5%	GRM022R60J122JE19#			
			±10%	GRM022B31A821KE19#				±10%	GRM022R60J122KE19#			
			±20%	GRM022B11A821MA12#			±20%	GRM022R60J122ME19#				
		1000pF	±20%	GRM022B31A821ME19#			1500pF	±5%	GRM022R60J152JE19#			
			±5%	GRM022B31A102JE19#				±10%	GRM022R60J152KE19#			
			±10%	GRM022B11A102KA12#				±20%	GRM022R60J152ME19#			
			±10%	GRM022B31A102KE19#			1800pF	±5%	GRM022R60J182JE19#			
		±20%	GRM022B11A102MA12#	±10%				GRM022R60J182KE19#				
		±20%	GRM022B31A102ME19#	±20%				GRM022R60J182ME19#				
		1200pF	±5%	GRM022B31A122JE19#			2200pF	±5%	GRM022R60J222JE19#			
			±10%	GRM022B31A122KE19#				±10%	GRM022R60J222KE19#			
			±20%	GRM022B31A122ME19#				±20%	GRM022R60J222ME19#			
		1500pF	±5%	GRM022B31A152JE19#				2700pF	±5%	GRM022R60J272JE19#		
			±10%	GRM022B31A152KE19#			±10%		GRM022R60J272KE19#			
			±20%	GRM022B31A152ME19#			±20%		GRM022R60J272ME19#			
		1800pF	±5%	GRM022B31A182JE19#			3300pF	±5%	GRM022R60J332JE19#			
			±10%	GRM022B31A182KE19#				±10%	GRM022R60J332KE19#			
			±20%	GRM022B31A182ME19#				±20%	GRM022R60J332ME19#			
		2200pF	±5%	GRM022B31A222JE19#			3900pF	±5%	GRM022R60J392JE19#			
			±10%	GRM022B31A222KE19#				±10%	GRM022R60J392KE19#			
			±20%	GRM022B31A222ME19#				±20%	GRM022R60J392ME19#			
		2700pF	±5%	GRM022B31A272JE19#			4700pF	±5%	GRM022R60J472JE19#			
			±10%	GRM022B31A272KE19#				±10%	GRM022R60J472KE19#			
			±20%	GRM022B31A272ME19#				±20%	GRM022R60J472ME19#			
		3300pF	±5%	GRM022B31A332JE19#			5600pF	±5%	GRM022R60J562JE19#			
			±10%	GRM022B31A332KE19#				±10%	GRM022R60J562KE19#			
			±20%	GRM022B31A332ME19#				±20%	GRM022R60J562ME19#			
		3900pF	±5%	GRM022B31A392JE19#			6800pF	±5%	GRM022R60J682JE19#			
			±10%	GRM022B31A392KE19#				±10%	GRM022R60J682KE19#			
			±20%	GRM022B31A392ME19#				±20%	GRM022R60J682ME19#			
		4700pF	±5%	GRM022B31A472JE19#			8200pF	±5%	GRM022R60J822JE19#			
			±10%	GRM022B31A472KE19#				±10%	GRM022R60J822KE19#			
			±20%	GRM022B31A472ME19#				±20%	GRM022R60J822ME19#			
		5600pF	±5%	GRM022B31A562JE19#			10000pF	±5%	GRM022R60J103JE19#			
			±10%	GRM022B31A562KE19#				±10%	GRM022R60J103KE19#			
			±20%	GRM022B31A562ME19#				±20%	GRM022R60J103ME19#			
		6800pF	±5%	GRM022B31A682JE19#			15000pF	±20%	GRM022R60J153ME15#	D1		
			±10%	GRM022B31A682KE19#			22000pF	±10%	GRM022R60J223KE15#	D1		
			±20%	GRM022B31A682ME19#				±20%	GRM022R60J223ME15#	D1		
		8200pF	±5%	GRM022B31A822JE19#			33000pF	±20%	GRM022R60J333ME15#	D1		
			±10%	GRM022B31A822KE19#			47000pF	±20%	GRM022R60J473ME15#	D1		
			±20%	GRM022B31A822ME19#			68000pF	±20%	GRM022R60J683ME15#	D1		
		10000pF	±5%	GRM022B31A103JE19#			0.10μF	±10%	GRM022R60J104KE15#	D1		
			±10%	GRM022B31A103KE19#				±20%	GRM022R60J104ME01#	Mo		
			±20%	GRM022B31A103ME19#				±20%	GRM022R60J104ME15#	D1		
		6.3Vdc	X5R	680pF			±5%	GRM022R60J681JE19#	0.22μF	±10%	GRM022R60J224KE14#	Mo D1
							±10%	GRM022R60J681KE19#		±20%	GRM022R60J224ME14#	Mo D1
							±20%	GRM022R60J681ME19#		0.47μF	±20%	GRM022R60J474ME05#
				820pF			±5%	GRM022R60J821JE19#	±20%		GRM022R60J474ME15#	Mo D1
							±10%	GRM022R60J821KE19#	B		680pF	±10%
				±20%			GRM022R60J821ME19#	±20%		GRM022B30J681ME19#		

Part number # indicates the package specification code.

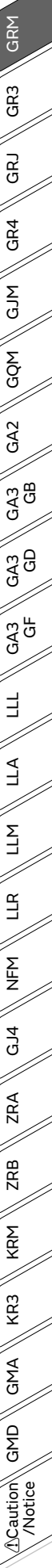

GRM Series High Dielectric Constant Type Part Number List

(→ 0.4×0.2mm)

Rated Voltage	TC Code	Cap.	Tol.	Part Number			
6.3Vdc	B	820pF	±10%	GRM022B30J821KE19#			
			±20%	GRM022B30J821ME19#			
		1000pF	±10%	GRM022B30J102KE19#			
			±20%	GRM022B30J102ME19#			
		1200pF	±10%	GRM022B30J122KE19#			
			±20%	GRM022B30J122ME19#			
		1500pF	±10%	GRM022B30J152KE19#			
			±20%	GRM022B30J152ME19#			
		1800pF	±10%	GRM022B30J182KE19#			
			±20%	GRM022B30J182ME19#			
		2200pF	±10%	GRM022B30J222KE19#			
			±20%	GRM022B30J222ME19#			
		2700pF	±10%	GRM022B30J272KE19#			
			±20%	GRM022B30J272ME19#			
		3300pF	±10%	GRM022B30J332KE19#			
			±20%	GRM022B30J332ME19#			
		3900pF	±10%	GRM022B30J392KE19#			
			±20%	GRM022B30J392ME19#			
		4700pF	±10%	GRM022B30J472KE19#			
			±20%	GRM022B30J472ME19#			
		5600pF	±10%	GRM022B30J562KE19#			
			±20%	GRM022B30J562ME19#			
		6800pF	±10%	GRM022B30J682KE19#			
			±20%	GRM022B30J682ME19#			
		8200pF	±10%	GRM022B30J822KE19#			
			±20%	GRM022B30J822ME19#			
		10000pF	±10%	GRM022B30J103KE19#			
			±20%	GRM022B30J103ME19#			
4Vdc	X6T	0.10μF	±20%	GRM022D80G104ME15#	D1		
		0.47μF	±20%	GRM022D80G474ME01#	D1		
	X5R	15000pF	±10%	GRM022R60G153KE15#			
			±20%	GRM022R60G153ME15#			
		22000pF	±10%	GRM022R60G223KE15#			
			±20%	GRM022R60G223ME15#			
		33000pF	±10%	GRM022R60G333KE15#			
			±20%	GRM022R60G333ME15#			
		47000pF	±10%	GRM022R60G473KE15#			
			±20%	GRM022R60G473ME15#			
		68000pF	±20%	GRM022R60G683ME15#			
		0.10μF	±20%	GRM022R60G104ME15#			
		0.22μF	±20%	GRM022R60G224ME14#	Mo		
		0.47μF	±20%	GRM022R60G474ME15#			
		2.5Vdc	X7T	0.47μF	±20%	GRM022D70E474ME01#	D1
			X6T	0.10μF	±20%	GRM022D80E104ME15#	
				0.22μF	±20%	GRM022D80E224ME14#	Mo
0.47μF	±20%			GRM022D80E474ME01#			
	±20%			GRM022D80E474ME05#	Mo D1		

0.5×0.25mm

Rated Voltage	TC Code	Cap.	Tol.	Part Number	
6.3Vdc	X5R	1.0μF	±20%	GRMMDXR60J105ME05#	Mo D1

0.6×0.3mm

Rated Voltage	TC Code	Cap.	Tol.	Part Number		
50Vdc	X7R	100pF	±10%	GRM033R71H101KA12#		
			±20%	GRM033R71H101MA12#		
		120pF	±10%	GRM033R71H121KA12#		
			±20%	GRM033R71H121MA12#		
		150pF	±10%	GRM033R71H151KA12#		
			±20%	GRM033R71H151MA12#		
		180pF	±10%	GRM033R71H181KA12#		
			±20%	GRM033R71H181MA12#		
		220pF	±10%	GRM033R71H221KA12#		
			±20%	GRM033R71H221MA12#		
		270pF	±10%	GRM033R71H271KA12#		
			±20%	GRM033R71H271MA12#		
		330pF	±10%	GRM033R71H331KA12#		
			±20%	GRM033R71H331MA12#		
		390pF	±10%	GRM033R71H391KA12#		
			±20%	GRM033R71H391MA12#		
		470pF	±10%	GRM033R71H471KA12#		
			±20%	GRM033R71H471MA12#		
		560pF	±10%	GRM033R71H561KA12#		
			±20%	GRM033R71H561MA12#		
		680pF	±10%	GRM033R71H681KA12#		
			±20%	GRM033R71H681MA12#		
		820pF	±10%	GRM033R71H821KA12#		
			±20%	GRM033R71H821MA12#		
		1000pF	±10%	GRM033R71H102KA12#		
			±20%	GRM033R71H102MA12#		
		1200pF	±10%	GRM033R71H122KA12#		
			±20%	GRM033R71H122MA12#		
		1500pF	±10%	GRM033R71H152KA12#		
			±20%	GRM033R71H152MA12#		
		X5R	470pF	±10%	GRM033R61H471KA12#	
		B	100pF	±10%	GRM033B31H101KA12#	
				±20%	GRM033B31H101MA12#	
		120pF	±10%	GRM033B31H121KA12#		
			±20%	GRM033B31H121MA12#		
		150pF	±10%	GRM033B31H151KA12#		
			±20%	GRM033B31H151MA12#		
		180pF	±10%	GRM033B31H181KA12#		
			±20%	GRM033B31H181MA12#		
		220pF	±10%	GRM033B31H221KA12#		
			±20%	GRM033B31H221MA12#		
		270pF	±10%	GRM033B31H271KA12#		
			±20%	GRM033B31H271MA12#		
		330pF	±10%	GRM033B31H331KA12#		
			±20%	GRM033B31H331MA12#		
		390pF	±10%	GRM033B31H391KA12#		
			±20%	GRM033B31H391MA12#		
		470pF	±10%	GRM033B31H471KA12#		
			±20%	GRM033B31H471MA12#		
		560pF	±10%	GRM033B31H561KA12#		
			±20%	GRM033B31H561MA12#		
		680pF	±10%	GRM033B31H681KA12#		

Part number # indicates the package specification code.



GRM Series High Dielectric Constant Type Part Number List

(→ 0.6×0.3mm)

Rated Voltage	TC Code	Cap.	Tol.	Part Number		Rated Voltage	TC Code	Cap.	Tol.	Part Number			
50Vdc	B	680pF	±20%	GRM033B31H681MA12#		25Vdc	X7R	1500pF	±10%	GRM033R71E152KA01#			
			±10%	GRM033B31H821KA12#					±20%	GRM033R71E152MA01#			
			±20%	GRM033B31H821MA12#					1800pF	±10%	GRM033R71E182KA12#		
		1000pF	±10%	GRM033B31H102KA12#						±20%	GRM033R71E182MA12#		
			±20%	GRM033B31H102MA12#						2200pF	±10%	GRM033R71E222KA12#	
		1200pF	±10%	GRM033B31H122KA12#					±20%		GRM033R71E222MA12#		
			1500pF	±10%	GRM033B31H152KA12#				2700pF	±10%	GRM033R71E272KA12#		
		±20%		GRM033B31H152MA12#				±20%		GRM033R71E272MA12#			
		35Vdc	X5R	0.10μF	±10%			GRM033R6YA104KE14#	D1	3300pF	±10%	GRM033R71E332KA12#	
					±20%			GRM033R6YA104ME14#	D1		±20%	GRM033R71E332MA12#	
		25Vdc	X7R	100pF	±5%			GRM033R71E101JA01#		3900pF	±10%	GRM033R71E392KE14#	D1
					±10%			GRM033R71E101KA01#			±20%	GRM033R71E392ME14#	D1
±20%	GRM033R71E101MA01#							4700pF	±10%		GRM033R71E472KE14#	D1	
120pF	±5%			GRM033R71E121JA01#					±20%		GRM033R71E472ME14#	D1	
	±10%			GRM033R71E121KA01#				5600pF	±10%		GRM033R71E562KE14#	D1	
	±20%			GRM033R71E121MA01#					±20%		GRM033R71E562ME14#	D1	
150pF	±5%			GRM033R71E151JA01#				6800pF	±10%	GRM033R71E682KE14#	D1		
	±10%			GRM033R71E151KA01#					±20%	GRM033R71E682ME14#	D1		
	±20%			GRM033R71E151MA01#				8200pF	±10%	GRM033R71E822KE14#	D1		
180pF	±5%			GRM033R71E181JA01#					±20%	GRM033R71E822ME14#	D1		
	±10%			GRM033R71E181KA01#				10000pF	±10%	GRM033R71E103KE14#	D1		
	±20%			GRM033R71E181MA01#					±20%	GRM033R71E103ME14#	D1		
220pF	±5%			GRM033R71E221JA01#				R	100pF	±5%	GRM033R11E101JA01#		
	±10%			GRM033R71E221KA01#						±10%	GRM033R11E101KA01#		
	±20%			GRM033R71E221MA01#		±20%	GRM033R11E101MA01#						
270pF	±5%			GRM033R71E271JA01#		120pF	±5%	GRM033R11E121JA01#					
	±10%			GRM033R71E271KA01#			±10%	GRM033R11E121KA01#					
	±20%			GRM033R71E271MA01#			±20%	GRM033R11E121MA01#					
330pF	±5%			GRM033R71E331JA01#		150pF	±5%	GRM033R11E151JA01#					
	±10%			GRM033R71E331KA01#			±10%	GRM033R11E151KA01#					
	±20%			GRM033R71E331MA01#			±20%	GRM033R11E151MA01#					
390pF	±5%			GRM033R71E391JA01#		180pF	±5%	GRM033R11E181JA01#					
	±10%			GRM033R71E391KA01#			±10%	GRM033R11E181KA01#					
	±20%			GRM033R71E391MA01#			±20%	GRM033R11E181MA01#					
470pF	±5%			GRM033R71E471JA01#		220pF	±5%	GRM033R11E221JA01#					
	±10%			GRM033R71E471KA01#			±10%	GRM033R11E221KA01#					
	±20%			GRM033R71E471MA01#			±20%	GRM033R11E221MA01#					
560pF	±5%			GRM033R71E561JA01#		270pF	±5%	GRM033R11E271JA01#					
	±10%			GRM033R71E561KA01#			±10%	GRM033R11E271KA01#					
	±20%			GRM033R71E561MA01#			±20%	GRM033R11E271MA01#					
680pF	±5%			GRM033R71E681JA01#		330pF	±5%	GRM033R11E331JA01#					
	±10%			GRM033R71E681KA01#			±10%	GRM033R11E331KA01#					
	±20%			GRM033R71E681MA01#			±20%	GRM033R11E331MA01#					
820pF	±5%			GRM033R71E821JA01#		390pF	±5%	GRM033R11E391JA01#					
	±10%			GRM033R71E821KA01#			±10%	GRM033R11E391KA01#					
	±20%			GRM033R71E821MA01#			±20%	GRM033R11E391MA01#					
1000pF	±5%			GRM033R71E102JA01#		470pF	±5%	GRM033R11E471JA01#					
	±10%			GRM033R71E102KA01#			±10%	GRM033R11E471KA01#					
	±20%			GRM033R71E102MA01#			±20%	GRM033R11E471MA01#					
1200pF	±5%			GRM033R71E122JA01#		560pF	±5%	GRM033R11E561JA01#					
	±10%			GRM033R71E122KA01#			±10%	GRM033R11E561KA01#					
	±20%			GRM033R71E122MA01#			±20%	GRM033R11E561MA01#					
1500pF	±5%			GRM033R71E152JA01#		680pF	±5%	GRM033R11E681JA01#					
							±10%	GRM033R11E681KA01#					

- GRM
- GR3
- GRJ
- GR4
- GJM
- GQM
- GA2
- GA3 GB
- GA3 GD
- GA3 GF
- LLL
- LLA
- LLM
- LLR
- NFM
- GJ4
- ZRA
- ZRB
- KRM
- KR3
- GMA
- GMD
- ⚠Caution /Notice

Part number # indicates the package specification code.

GRM Series High Dielectric Constant Type Part Number List

(→ 0.6×0.3mm)

Rated Voltage	TC Code	Cap.	Tol.	Part Number		Rated Voltage	TC Code	Cap.	Tol.	Part Number		
25Vdc	R	680pF	±20%	GRM033R11E681MA01#		25Vdc	B	220pF	±10%	GRM033B11E221KA01#		
			±5%	GRM033R11E821JA01#					±20%	GRM033B11E221MA01#		
			±10%	GRM033R11E821KA01#				270pF	±10%	GRM033B11E271KA01#		
			±20%	GRM033R11E821MA01#					±20%	GRM033B11E271MA01#		
		1000pF	±5%	GRM033R11E102JA01#				330pF	±10%	GRM033B11E331KA01#		
			±10%	GRM033R11E102KA01#					±20%	GRM033B11E331MA01#		
			±20%	GRM033R11E102MA01#					390pF	±10%	GRM033B11E391KA01#	
		1200pF	±5%	GRM033R11E122JA01#				±20%		GRM033B11E391MA01#		
			±10%	GRM033R11E122KA01#				470pF	±10%	GRM033B11E471KA01#		
			±20%	GRM033R11E122MA01#					±20%	GRM033B11E471MA01#		
		1500pF	±5%	GRM033R11E152JA01#				560pF	±10%	GRM033B11E561KA01#		
			±10%	GRM033R11E152KA01#					±20%	GRM033B11E561MA01#		
			±20%	GRM033R11E152MA01#				680pF	±10%	GRM033B11E681KA01#		
		10000pF	±10%	GRM033C81E103KE14#	D1				±20%	GRM033B11E681MA01#		
			±20%	GRM033C81E103ME14#	D1			820pF	±10%	GRM033B11E821KA01#		
	0.10μF	±10%	GRM033C81E104KE14#	D1	±20%				GRM033B11E821MA01#			
		±20%	GRM033C81E104ME14#	D1	1000pF			±10%	GRM033B11E102KA01#			
	X5R	100pF	±10%	GRM033R61E101KA01#					±20%	GRM033B11E102MA01#		
			±10%	GRM033R61E121KA01#				1200pF	±10%	GRM033B11E122KA01#		
			±10%	GRM033R61E151KA01#					±20%	GRM033B11E122MA01#		
			±10%	GRM033R61E181KA01#				1500pF	±10%	GRM033B11E152KA01#		
			±10%	GRM033R61E221KA01#					±20%	GRM033B11E152MA01#		
			±10%	GRM033R61E271KA01#				1800pF	±10%	GRM033B31E182KA12#		
			±10%	GRM033R61E331KA01#					±20%	GRM033B31E182MA12#		
			±10%	GRM033R61E391KA01#				2200pF	±10%	GRM033B31E222KA12#		
			±10%	GRM033R61E471KA01#					±20%	GRM033B31E222MA12#		
			±10%	GRM033R61E561KA01#				2700pF	±10%	GRM033B31E272KA12#		
			±10%	GRM033R61E681KA01#					±20%	GRM033B31E272MA12#		
			±10%	GRM033R61E821KA01#				3300pF	±10%	GRM033B31E332KA12#		
			±10%	GRM033R61E102KA01#					±20%	GRM033B31E332MA12#		
			3900pF	±10%	GRM033R61E392KA12#			D1	4700pF	±10%	GRM033B31E472KA12#	D1
				±20%	GRM033R61E392MA12#			D1		±20%	GRM033B31E472MA12#	D1
	4700pF	±10%	GRM033R61E472KA12#	D1	5600pF			±10%	GRM033R71C101JA01#			
±20%		GRM033R61E472MA12#	D1	±10%		GRM033R71C101KA01#						
5600pF	±10%	GRM033R61E562KA12#	D1	±20%	GRM033R71C101MA01#							
	±20%	GRM033R61E562MA12#	D1	120pF	±5%	GRM033R71C121JA01#						
6800pF	±10%	GRM033R61E682KA12#	D1		±10%	GRM033R71C121KA01#						
	±20%	GRM033R61E682MA12#	D1	±20%	GRM033R71C121MA01#							
8200pF	±10%	GRM033R61E822KA12#	D1	150pF	±5%	GRM033R71C151JA01#						
	±20%	GRM033R61E822MA12#	D1		±10%	GRM033R71C151KA01#						
10000pF	±10%	GRM033R61E103KA12#	D1	±20%	GRM033R71C151MA01#							
	±20%	GRM033R61E103MA12#	D1	180pF	±5%	GRM033R71C181JA01#						
0.10μF	±10%	GRM033R61E104KE14#			±10%	GRM033R71C181KA01#						
	±20%	GRM033R61E104ME14#			±20%	GRM033R71C181MA01#						
0.22μF	±10%	GRM033R61E224KE01#	D1	220pF	±5%	GRM033R71C221JA01#						
	±20%	GRM033R61E224ME01#	D1		±10%	GRM033R71C221KA01#						
B	100pF	±10%	GRM033B11E101KA01#			±20%	GRM033R71C221MA01#					
		±20%	GRM033B11E101MA01#		270pF	±5%	GRM033R71C271JA01#					
	±10%	GRM033B11E121KA01#		±10%		GRM033R71C271KA01#						
	±20%	GRM033B11E121MA01#		±20%		GRM033R71C271MA01#						
	150pF	±10%	GRM033B11E151KA01#		330pF	±5%	GRM033R71C331JA01#					
		±20%	GRM033B11E151MA01#			±10%	GRM033R71C331KA01#					
±10%	GRM033B11E181KA01#		±20%	GRM033R71C331MA01#								
±20%	GRM033B11E181MA01#											

Part number # indicates the package specification code.



GRM Series High Dielectric Constant Type Part Number List

(→ 0.6×0.3mm)

Rated Voltage	TC Code	Cap.	Tol.	Part Number		Rated Voltage	TC Code	Cap.	Tol.	Part Number		
16Vdc	X7R	390pF	±5%	GRM033R71C391JA01#		16Vdc	R	150pF	±20%	GRM033R11C151MA01#		
			±10%	GRM033R71C391KA01#					180pF	±5%	GRM033R11C181JA01#	
			±20%	GRM033R71C391MA01#						±10%	GRM033R11C181KA01#	
		±5%	GRM033R71C471JA01#		±20%			GRM033R11C181MA01#				
		470pF	±10%	GRM033R71C471KA01#				220pF	±5%	GRM033R11C221JA01#		
			±20%	GRM033R71C471MA01#					±10%	GRM033R11C221KA01#		
			±5%	GRM033R71C561JA01#					±20%	GRM033R11C221MA01#		
		560pF	±10%	GRM033R71C561KA01#				270pF	±5%	GRM033R11C271JA01#		
			±20%	GRM033R71C561MA01#					±10%	GRM033R11C271KA01#		
			±5%	GRM033R71C681JA01#					±20%	GRM033R11C271MA01#		
		680pF	±10%	GRM033R71C681KA01#				330pF	±5%	GRM033R11C331JA01#		
			±20%	GRM033R71C681MA01#					±10%	GRM033R11C331KA01#		
			±5%	GRM033R71C821JA01#					±20%	GRM033R11C331MA01#		
		820pF	±10%	GRM033R71C821KA01#				390pF	±5%	GRM033R11C391JA01#		
			±20%	GRM033R71C821MA01#					±10%	GRM033R11C391KA01#		
			±5%	GRM033R71C102JA01#					±20%	GRM033R11C391MA01#		
		1000pF	±10%	GRM033R71C102KA01#				470pF	±5%	GRM033R11C471JA01#		
			±20%	GRM033R71C102MA01#					±10%	GRM033R11C471KA01#		
			±5%	GRM033R71C122JA01#					±20%	GRM033R11C471MA01#		
		1200pF	±10%	GRM033R71C122KA01#				560pF	±5%	GRM033R11C561JA01#		
			±20%	GRM033R71C122MA01#					±10%	GRM033R11C561KA01#		
			±5%	GRM033R71C152JA01#					±20%	GRM033R11C561MA01#		
		1500pF	±10%	GRM033R71C152KA01#				680pF	±5%	GRM033R11C681JA01#		
			±20%	GRM033R71C152MA01#					±10%	GRM033R11C681KA01#		
			±10%	GRM033R71C182KA88#					±20%	GRM033R11C681MA01#		
		1800pF	±20%	GRM033R71C182MA88#				820pF	±5%	GRM033R11C821JA01#		
			±10%	GRM033R71C222KA88#					±10%	GRM033R11C821KA01#		
			±20%	GRM033R71C222MA88#					±20%	GRM033R11C821MA01#		
		2200pF	±10%	GRM033R71C272KA88#				1000pF	±5%	GRM033R11C102JA01#		
			±20%	GRM033R71C272MA88#					±10%	GRM033R11C102KA01#		
			±10%	GRM033R71C332KA88#					±20%	GRM033R11C102MA01#		
		3300pF	±20%	GRM033R71C332MA88#				1200pF	±5%	GRM033R11C122JA01#		
			±10%	GRM033R71C392KE14#					±10%	GRM033R11C122KA01#		
			±20%	GRM033R71C392ME14#					±20%	GRM033R11C122MA01#		
		3900pF	±10%	GRM033R71C472KE14#				1500pF	±5%	GRM033R11C152JA01#		
			±20%	GRM033R71C472ME14#					±10%	GRM033R11C152KA01#		
			±10%	GRM033R71C562KE14#					±20%	GRM033R11C152MA01#		
		4700pF	±20%	GRM033R71C562ME14#				1800pF	±10%	GRM033R11C182KA88#		
			±10%	GRM033R71C682KE14#					±20%	GRM033R11C182MA88#		
			±20%	GRM033R71C682ME14#					2200pF	±10%	GRM033R11C222KA88#	
		±10%	GRM033R71C822KE14#		±20%			GRM033R11C222MA88#				
		±20%	GRM033R71C822ME14#		2700pF			±10%		GRM033R11C272KA88#		
	±10%	GRM033R71C103KE14#		±20%		GRM033R11C272MA88#						
	±20%	GRM033R71C103ME14#		3300pF		±10%	GRM033R11C332KA88#					
	X7S	0.10μF	±10%		GRM033C71C104KE14#	D1	X6S	0.10μF	±10%	GRM033C81C104KE14#		
			±20%		GRM033C71C104ME14#	D1			±20%	GRM033C81C104ME14#		
	R	100pF	±5%	GRM033R11C101JA01#		X5R	2200pF	±10%	GRM033R61C222KA88#			
			±10%	GRM033R11C101KA01#				1000pF	±10%	GRM033R61C103KA12#		
			±20%	GRM033R11C101MA01#					±20%	GRM033R61C103MA12#		
		120pF	±5%	GRM033R11C121JA01#		12000pF	±10%	GRM033R61C123KE84#	D1			
			±10%	GRM033R11C121KA01#			±20%	GRM033R61C123ME84#	D1			
			±20%	GRM033R11C121MA01#			15000pF	±10%	GRM033R61C153KE84#	D1		
		±5%	GRM033R11C151JA01#		±20%	GRM033R61C153ME84#		D1				
		±10%	GRM033R11C151KA01#									

Part number # indicates the package specification code.



GRM Series High Dielectric Constant Type Part Number List

(→ 0.6×0.3mm)

Rated Voltage	TC Code	Cap.	Tol.	Part Number		Rated Voltage	TC Code	Cap.	Tol.	Part Number	
16Vdc	X5R	18000pF	±10%	GRM033R61C183KE84#	D1	16Vdc	B	560pF	±10%	GRM033B11C561KA01#	
			±20%	GRM033R61C183ME84#	D1				±20%	GRM033B11C561MA01#	
		22000pF	±10%	GRM033R61C223KE84#	D1			680pF	±5%	GRM033B11C681JA01#	
			±20%	GRM033R61C223ME84#	D1				±10%	GRM033B11C681KA01#	
		27000pF	±10%	GRM033R61C273KE84#	D1			820pF	±20%	GRM033B11C681MA01#	
			±20%	GRM033R61C273ME84#	D1				±5%	GRM033B11C821JA01#	
		33000pF	±10%	GRM033R61C333KE84#	D1				±10%	GRM033B11C821KA01#	
			±20%	GRM033R61C333ME84#	D1			±20%	GRM033B11C821MA01#		
		39000pF	±10%	GRM033R61C393KE84#	D1			1000pF	±5%	GRM033B11C102JA01#	
			±20%	GRM033R61C393ME84#	D1				±10%	GRM033B11C102KA01#	
		47000pF	±10%	GRM033R61C473KE84#	D1			1200pF	±20%	GRM033B11C102MA01#	
			±20%	GRM033R61C473ME84#	D1				±5%	GRM033B11C122JA01#	
		56000pF	±10%	GRM033R61C563KE84#	D1				±10%	GRM033B11C122KA01#	
			±20%	GRM033R61C563ME84#	D1			±20%	GRM033B11C122MA01#		
		68000pF	±10%	GRM033R61C683KE84#	D1			1500pF	±5%	GRM033B11C152JA01#	
			±20%	GRM033R61C683ME84#	D1				±10%	GRM033B11C152KA01#	
		82000pF	±10%	GRM033R61C823KE84#	D1				±20%	GRM033B11C152MA01#	
			±20%	GRM033R61C823ME84#	D1			1800pF	±10%	GRM033B31C182KA87#	
		0.10μF	±10%	GRM033R61C104KE14#					±20%	GRM033B31C182MA87#	
			±10%	GRM033R61C104KE18#	D1			2200pF	±10%	GRM033B31C222KA87#	
			±20%	GRM033R61C104ME14#					±20%	GRM033B31C222MA87#	
			±20%	GRM033R61C104ME18#	D1			2700pF	±10%	GRM033B31C272KA87#	
		0.22μF	±10%	GRM033R61C224KE14#					±20%	GRM033B31C272MA87#	
			±20%	GRM033R61C224ME14#				3300pF	±10%	GRM033B31C332KA87#	
		1.0μF	±20%	GRM033R61C105ME15#	Mo D1				±20%	GRM033B31C332MA87#	
			2.2μF	±20%	GRM035R61C225ME01#			Mo D1	10000pF	±10%	GRM033B31C103KA12#
		±20%						±20%		GRM033B31C103MA12#	
		100pF	±5%	GRM033B11C101JA01#				12000pF	±10%	GRM033B31C123KE84#	D1
			±10%	GRM033B11C101KA01#					±20%	GRM033B31C123ME84#	D1
			±20%	GRM033B11C101MA01#				15000pF	±10%	GRM033B31C153KE84#	D1
		120pF	±5%	GRM033B11C121JA01#					±20%	GRM033B31C153ME84#	D1
			±10%	GRM033B11C121KA01#				18000pF	±10%	GRM033B31C183KE84#	D1
			±20%	GRM033B11C121MA01#					±20%	GRM033B31C183ME84#	D1
		150pF	±5%	GRM033B11C151JA01#				22000pF	±10%	GRM033B31C223KE84#	D1
			±10%	GRM033B11C151KA01#					±20%	GRM033B31C223ME84#	D1
			±20%	GRM033B11C151MA01#				27000pF	±10%	GRM033B31C273KE84#	D1
		180pF	±5%	GRM033B11C181JA01#					±20%	GRM033B31C273ME84#	D1
			±10%	GRM033B11C181KA01#				33000pF	±10%	GRM033B31C333KE84#	D1
			±20%	GRM033B11C181MA01#					±20%	GRM033B31C333ME84#	D1
		220pF	±5%	GRM033B11C221JA01#				39000pF	±10%	GRM033B31C393KE84#	D1
			±10%	GRM033B11C221KA01#					±20%	GRM033B31C393ME84#	D1
			±20%	GRM033B11C221MA01#				47000pF	±10%	GRM033B31C473KE84#	D1
		270pF	±5%	GRM033B11C271JA01#					±20%	GRM033B31C473ME84#	D1
			±10%	GRM033B11C271KA01#				56000pF	±10%	GRM033B31C563KE84#	D1
			±20%	GRM033B11C271MA01#					±20%	GRM033B31C563ME84#	D1
		330pF	±5%	GRM033B11C331JA01#				68000pF	±10%	GRM033B31C683KE84#	D1
			±10%	GRM033B11C331KA01#					±20%	GRM033B31C683ME84#	D1
			±20%	GRM033B11C331MA01#				82000pF	±10%	GRM033B31C823KE84#	D1
390pF	±5%	GRM033B11C391JA01#		±20%	GRM033B31C823ME84#	D1					
	±10%	GRM033B11C391KA01#		0.10μF	±10%	GRM033B31C104KE84#	D1				
	±20%	GRM033B11C391MA01#			±20%	GRM033B31C104ME84#	D1				
470pF	±5%	GRM033B11C471JA01#		X7R	±10%	GRM033Z71C104KE14#	D1				
	±10%	GRM033B11C471KA01#			±20%	GRM033Z71C104ME14#	D1				
	±20%	GRM033B11C471MA01#		10Vdc	X7R	1200pF	±5%	GRM033R71A122JA01#			

- GRM
- GR3
- GRJ
- GR4
- GJM
- GQM
- GA2
- GA3 GB
- GA3 GD
- GA3 GF
- LLL
- LLA
- LLM
- LLR
- NFM
- GJ4
- ZRA
- ZRB
- KRM
- KR3
- GMA
- GMD
- ⚠Caution /Notice

Part number # indicates the package specification code.

GRM Series High Dielectric Constant Type Part Number List

(→ 0.6×0.3mm)

Rated Voltage	TC Code	Cap.	Tol.	Part Number		Rated Voltage	TC Code	Cap.	Tol.	Part Number		
10Vdc	X7R	1200pF	±10%	GRM033R71A122KA01#		10Vdc	R	3300pF	±20%	GRM033R11A332MA01#		
			±20%	GRM033R71A122MA01#					3900pF	±5%	GRM033R11A392JA01#	
		1500pF	±5%	GRM033R71A152JA01#				±10%		GRM033R11A392KA01#		
			±10%	GRM033R71A152KA01#				±20%	GRM033R11A392MA01#			
			1800pF	±20%	GRM033R71A152MA01#				4700pF	±5%	GRM033R11A472JA01#	
				±5%	GRM033R71A182JA01#					±10%	GRM033R11A472KA01#	
		±10%		GRM033R71A182KA01#				±20%		GRM033R11A472MA01#		
		2200pF	±20%	GRM033R71A182MA01#				5600pF	±5%	GRM033R11A562JA01#		
			±5%	GRM033R71A222JA01#					±10%	GRM033R11A562KA01#		
			±10%	GRM033R71A222KA01#					±20%	GRM033R11A562MA01#		
		2700pF	±20%	GRM033R71A222MA01#				6800pF	±5%	GRM033R11A682JA01#		
			±5%	GRM033R71A272JA01#					±10%	GRM033R11A682KA01#		
			±10%	GRM033R71A272KA01#					±20%	GRM033R11A682MA01#		
		3300pF	±20%	GRM033R71A272MA01#				8200pF	±5%	GRM033R11A822JA01#		
			±5%	GRM033R71A332JA01#					±10%	GRM033R11A822KA01#		
			±10%	GRM033R71A332KA01#					±20%	GRM033R11A822MA01#		
		3900pF	±20%	GRM033R71A332MA01#				10000pF	±5%	GRM033R11A103JA01#		
			±5%	GRM033R71A392JA01#					±10%	GRM033R11A103KA01#		
			±10%	GRM033R71A392KA01#					±20%	GRM033R11A103MA01#		
		4700pF	±20%	GRM033R71A392MA01#				X6S	4700pF	±10%	GRM033C81A473KE05#	D1
			±5%	GRM033R71A472JA01#						±20%	GRM033C81A473ME05#	D1
			±10%	GRM033R71A472KA01#					0.10μF	±10%	GRM033C81A104KE14#	
		±20%	GRM033R71A472MA01#		±20%			GRM033C81A104ME14#				
		5600pF	±5%	GRM033R71A562JA01#				1.0μF	±20%	GRM033C81A105ME05#	D1	
			±10%	GRM033R71A562KA01#					X5R	1200pF	±5%	GRM033R61A122JA01#
			±20%	GRM033R71A562MA01#				±10%			GRM033R61A122KA01#	
		±5%	GRM033R71A682JA01#		±20%			GRM033R61A122MA01#				
		6800pF	±10%	GRM033R71A682KA01#				1500pF	±5%	GRM033R61A152JA01#		
			±20%	GRM033R71A682MA01#					±10%	GRM033R61A152KA01#		
			±5%	GRM033R71A822JA01#					±20%	GRM033R61A152MA01#		
		8200pF	±10%	GRM033R71A822KA01#				1800pF	±5%	GRM033R61A182JA01#		
			±20%	GRM033R71A822MA01#					±10%	GRM033R61A182KA01#		
			±5%	GRM033R71A103JA01#					±20%	GRM033R61A182MA01#		
		10000pF	±10%	GRM033R71A103KA01#				2200pF	±5%	GRM033R61A222JA01#		
			±20%	GRM033R71A103MA01#					±10%	GRM033R61A222KA01#		
			±5%	GRM033R71A104KE14#					±20%	GRM033R61A222MA01#		
	X7S	0.10μF	±10%	GRM033C71A104ME14#			2700pF	±5%	GRM033R61A272JA01#			
			±20%	GRM033C71A104ME14#				±10%	GRM033R61A272KA01#			
	R	1200pF	±5%	GRM033R11A122JA01#			±20%	GRM033R61A272MA01#				
			±10%	GRM033R11A122KA01#			3300pF	±5%	GRM033R61A332JA01#			
			±20%	GRM033R11A122MA01#				±10%	GRM033R61A332KA01#			
		±5%	GRM033R11A152JA01#		±20%			GRM033R61A332MA01#				
		1500pF	±10%	GRM033R11A152KA01#			3900pF	±5%	GRM033R61A392JA01#			
			±20%	GRM033R11A152MA01#				±10%	GRM033R61A392KA01#			
			±5%	GRM033R11A182JA01#				±20%	GRM033R61A392MA01#			
		1800pF	±10%	GRM033R11A182KA01#			4700pF	±5%	GRM033R61A472JA01#			
			±20%	GRM033R11A182MA01#				±10%	GRM033R61A472KA01#			
			±5%	GRM033R11A222JA01#				±20%	GRM033R61A472MA01#			
		2200pF	±10%	GRM033R11A222KA01#			5600pF	±5%	GRM033R61A562JA01#			
			±20%	GRM033R11A222MA01#				±10%	GRM033R61A562KA01#			
			±5%	GRM033R11A272JA01#				±20%	GRM033R61A562MA01#			
		2700pF	±10%	GRM033R11A272KA01#			6800pF	±5%	GRM033R61A682JA01#			
			±20%	GRM033R11A272MA01#				±10%	GRM033R61A682KA01#			
			±5%	GRM033R11A332JA01#				±20%	GRM033R61A682MA01#			
3300pF		±10%	GRM033R11A332KA01#									

Part number # indicates the package specification code.

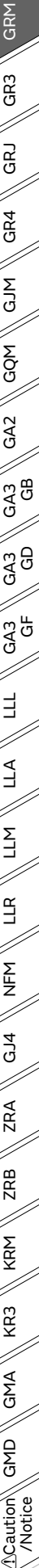

GRM Series High Dielectric Constant Type Part Number List

(→ 0.6×0.3mm)

Rated Voltage	TC Code	Cap.	Tol.	Part Number		Rated Voltage	TC Code	Cap.	Tol.	Part Number		
10Vdc	X5R	8200pF	±5%	GRM033R61A822JA01#		10Vdc	B	3300pF	±10%	GRM033B11A332KA01#		
			±10%	GRM033R61A822KA01#					±20%	GRM033B11A332MA01#		
			±20%	GRM033R61A822MA01#					3900pF	±5%	GRM033B11A392JA01#	
		10000pF	±5%	GRM033R61A103JA01#				±10%		GRM033B11A392KA01#		
			±10%	GRM033R61A103KA01#				±20%		GRM033B11A392MA01#		
			±20%	GRM033R61A103MA01#				4700pF	±5%	GRM033B11A472JA01#		
		12000pF	±10%	GRM033R61A123KE84#					±10%	GRM033B11A472KA01#		
			±20%	GRM033R61A123ME84#					±20%	GRM033B11A472MA01#		
		15000pF	±10%	GRM033R61A153KE84#				5600pF	±5%	GRM033B11A562JA01#		
			±20%	GRM033R61A153ME84#					±10%	GRM033B11A562KA01#		
		18000pF	±10%	GRM033R61A183KE84#				±20%	GRM033B11A562MA01#			
			±20%	GRM033R61A183ME84#				6800pF	±5%	GRM033B11A682JA01#		
		22000pF	±10%	GRM033R61A223KE84#					±10%	GRM033B11A682KA01#		
			±20%	GRM033R61A223ME84#					±20%	GRM033B11A682MA01#		
		27000pF	±10%	GRM033R61A273KE84#				8200pF	±5%	GRM033B11A822JA01#		
			±20%	GRM033R61A273ME84#					±10%	GRM033B11A822KA01#		
		33000pF	±10%	GRM033R61A333KE84#					±20%	GRM033B11A822MA01#		
			±20%	GRM033R61A333ME84#				10000pF	±5%	GRM033B11A103JA01#		
		39000pF	±10%	GRM033R61A393KE84#					±10%	GRM033B11A103KA01#		
			±20%	GRM033R61A393ME84#					±20%	GRM033B11A103MA01#		
		47000pF	±10%	GRM033R61A473KE84#				12000pF	±10%	GRM033B31A123KE84#		
			±20%	GRM033R61A473ME84#					±20%	GRM033B31A123ME84#		
		56000pF	±10%	GRM033R61A563KE15#				15000pF	±10%	GRM033B31A153KE84#		
			±20%	GRM033R61A563ME15#					±20%	GRM033B31A153ME84#		
		68000pF	±10%	GRM033R61A683KE15#				18000pF	±10%	GRM033B31A183KE84#		
			±20%	GRM033R61A683ME15#					±20%	GRM033B31A183ME84#		
		82000pF	±10%	GRM033R61A823KE15#				22000pF	±10%	GRM033B31A223KE84#		
			±20%	GRM033R61A823ME15#					±20%	GRM033B31A223ME84#		
		0.10μF	±10%	GRM033R61A104KE15#				27000pF	±10%	GRM033B31A273KE84#		
			±20%	GRM033R61A104ME15#					±20%	GRM033B31A273ME84#		
		0.22μF	±10%	GRM033R61A224KE90#	D1			33000pF	±10%	GRM033B31A333KE84#		
			±20%	GRM033R61A224ME90#	D1				±20%	GRM033B31A333ME84#		
		1.0μF	±20%	GRM033R61A105ME15#				39000pF	±10%	GRM033B31A393KE84#		
			±20%	GRM033R61A105ME44#	Mo D1				±20%	GRM033B31A393ME84#		
		2.2μF	±10%	GRM033R61A225KE47#	Mo D1			47000pF	±10%	GRM033B31A473KE84#		
			±20%	GRM033R61A225ME47#	Mo D1				±20%	GRM033B31A473ME84#		
			±20%	GRM035R61A225ME01#					56000pF	±10%	GRM033B31A563KE15#	
		B	±10%	GRM033B11A102KA01#				±20%		GRM033B31A563ME15#		
			1200pF	±5%	GRM033B11A122JA01#				68000pF	±10%	GRM033B31A683KE15#	
				±10%	GRM033B11A122KA01#					±20%	GRM033B31A683ME15#	
		±20%		GRM033B11A122MA01#				82000pF		±10%	GRM033B31A823KE15#	
		±20%	GRM033B11A122MA01#		±20%				GRM033B31A823ME15#			
1500pF	±5%	GRM033B11A152JA01#		0.10μF	±10%	GRM033B31A104KE15#						
	±10%	GRM033B11A152KA01#			±20%	GRM033B31A104ME15#						
	±20%	GRM033B11A152MA01#			X7R	±10%	GRM033Z71A104KE14#					
1800pF	±5%	GRM033B11A182JA01#		±20%		GRM033Z71A104ME14#						
	±10%	GRM033B11A182KA01#		6.3Vdc		X7R	1200pF	±5%	GRM033R70J122JA01#			
	±20%	GRM033B11A182MA01#			±10%			GRM033R70J122KA01#				
±20%	GRM033B11A182MA01#		±10%		GRM033R70J152JA01#							
2200pF	±5%	GRM033B11A222JA01#		±10%	GRM033R70J152KA01#							
	±10%	GRM033B11A222KA01#		±10%	GRM033R70J152KA01#							
	±20%	GRM033B11A222MA01#		1800pF	±5%	GRM033R70J182JA01#						
2700pF	±5%	GRM033B11A272JA01#			±10%	GRM033R70J182KA01#						
	±10%	GRM033B11A272KA01#		±20%	GRM033R70J222JA01#							
	±20%	GRM033B11A272MA01#		2200pF	±5%	GRM033R70J222JA01#						
±20%	GRM033B11A272MA01#		±10%		GRM033R70J222KA01#							
3300pF	±5%	GRM033B11A332JA01#										

- GRM
- GR3
- GRJ
- GR4
- GJM
- GQM
- GA2
- GA3 GB
- GA3 GD
- GA3 GF
- LLL
- LLA
- LLM
- LLR
- NFM
- GJ4
- ZRA
- ZRB
- KRM
- KR3
- GMA
- GMD
- ⚠Caution /Notice

Part number # indicates the package specification code.

GRM Series High Dielectric Constant Type Part Number List

(→ 0.6×0.3mm)

Rated Voltage	TC Code	Cap.	Tol.	Part Number		Rated Voltage	TC Code	Cap.	Tol.	Part Number	
6.3Vdc	X7R	2700pF	±5%	GRM033R70J272JA01#		6.3Vdc	X6S	3300pF	±20%	GRM033C80J333ME01#	
			±10%	GRM033R70J272KA01#					3900pF	±10%	GRM033C80J393KE19#
		3300pF	±5%	GRM033R70J332JA01#				±20%		GRM033C80J393ME19#	
			±10%	GRM033R70J332KA01#				4700pF	±10%	GRM033C80J473KE19#	
		3900pF	±5%	GRM033R70J392JA01#					±20%	GRM033C80J473ME19#	
			±10%	GRM033R70J392KA01#				5600pF	±10%	GRM033C80J563KE15#	D1
		4700pF	±5%	GRM033R70J472JA01#					±20%	GRM033C80J563ME15#	D1
			±10%	GRM033R70J472KA01#				6800pF	±10%	GRM033C80J683KE15#	D1
		5600pF	±5%	GRM033R70J562JA01#					±20%	GRM033C80J683ME15#	D1
			±10%	GRM033R70J562KA01#				8200pF	±10%	GRM033C80J823KE15#	D1
		6800pF	±5%	GRM033R70J682JA01#					±20%	GRM033C80J823ME15#	D1
			±10%	GRM033R70J682KA01#				0.10μF	±10%	GRM033C80J104KE15#	D1
		8200pF	±5%	GRM033R70J822JA01#					±20%	GRM033C80J104ME15#	D1
			±10%	GRM033R70J822KA01#				0.22μF	±10%	GRM033C80J224KE90#	D1
		10000pF	±5%	GRM033R70J103JA01#					±20%	GRM033C80J224ME90#	D1
			±10%	GRM033R70J103KA01#				1.0μF	±20%	GRM033C80J105ME05#	
		X7S	0.10μF	±10%	GRM033C70J104KE14#					2.2μF	±20%
	±20%			GRM033C70J104ME14#			X5R	2200pF	±10%		GRM033R60J222KA01#
	X7T	1.0μF	±20%	GRM033D70J105ME01#	D1				1000pF	±10%	GRM033R60J103KA01#
			R	1200pF	±5%		GRM033R10J122JA01#			1200pF	±10%
	±10%	GRM033R10J122KA01#					±20%	GRM033R60J123ME01#			
	1500pF	±5%	GRM033R10J152JA01#		1500pF		±10%	GRM033R60J153KE01#			
		±10%	GRM033R10J152KA01#				±20%	GRM033R60J153ME01#			
	1800pF	±5%	GRM033R10J182JA01#		1800pF		±10%	GRM033R60J183KE01#			
		±10%	GRM033R10J182KA01#				±20%	GRM033R60J183ME01#			
	2200pF	±5%	GRM033R10J222JA01#		2200pF		±10%	GRM033R60J223KE01#			
		±10%	GRM033R10J222KA01#				±20%	GRM033R60J223ME01#			
	2700pF	±5%	GRM033R10J272JA01#		2700pF		±10%	GRM033R60J273KE01#			
		±10%	GRM033R10J272KA01#				±20%	GRM033R60J273ME01#			
	3300pF	±5%	GRM033R10J332JA01#		3300pF		±10%	GRM033R60J333KE01#			
		±10%	GRM033R10J332KA01#				±20%	GRM033R60J333ME01#			
	3900pF	±5%	GRM033R10J392JA01#		3900pF		±10%	GRM033R60J393KE19#			
		±10%	GRM033R10J392KA01#				±20%	GRM033R60J393ME19#			
	4700pF	±5%	GRM033R10J472JA01#		4700pF		±5%	GRM033R60J473JE19#			
		±10%	GRM033R10J472KA01#				±10%	GRM033R60J473KE19#			
	5600pF	±5%	GRM033R10J562JA01#		±20%		GRM033R60J473ME19#				
		±10%	GRM033R10J562KA01#		5600pF		±10%	GRM033R60J563KE19#			
6800pF	±5%	GRM033R10J682JA01#		±20%		GRM033R60J563ME19#					
	±10%	GRM033R10J682KA01#		6800pF	±10%	GRM033R60J683KE19#					
8200pF	±5%	GRM033R10J822JA01#			±20%	GRM033R60J683ME19#					
	±10%	GRM033R10J822KA01#		8200pF	±10%	GRM033R60J823KE19#					
10000pF	±5%	GRM033R10J103JA01#			±20%	GRM033R60J823ME19#					
	±10%	GRM033R10J103KA01#		0.10μF	±10%	GRM033R60J104KE19#					
X6S	12000pF	±10%	GRM033C80J123KE01#			±20%	GRM033R60J104ME19#				
		±20%	GRM033C80J123ME01#		0.22μF	±10%	GRM033R60J224KE15#	D1			
15000pF	±10%	GRM033C80J153KE01#		±10%		GRM033R60J224KE90#					
	±20%	GRM033C80J153ME01#		±20%	GRM033R60J224ME15#	D1					
18000pF	±10%	GRM033C80J183KE01#		0.33μF	±20%	GRM033R60J334ME90#	D1				
	±20%	GRM033C80J183ME01#			0.47μF	±10%	GRM033R60J474KE90#	D1			
22000pF	±10%	GRM033C80J223KE01#		±20%		GRM033R60J474ME90#	D1				
	±20%	GRM033C80J223ME01#		1.0μF	±20%	GRM032R60J105ME05#	Mo D1				
27000pF	±10%	GRM033C80J273KE01#			±20%	GRM033R60J105MEA2#	D1				
	±20%	GRM033C80J273ME01#		1.5μF	±20%	GRM033R60J155ME14#	Mo D1				
33000pF	±10%	GRM033C80J333KE01#									

Part number # indicates the package specification code.

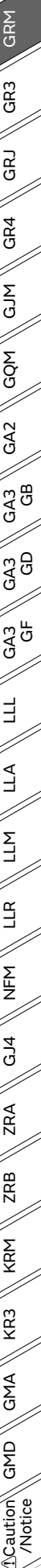

GRM Series High Dielectric Constant Type Part Number List

(→ 0.6×0.3mm)

Rated Voltage	TC Code	Cap.	Tol.	Part Number	
6.3Vdc	X5R	2.2μF	±20%	GRM033R60J225ME05#	Mo D1
			±20%	GRM033R60J225ME15#	Mo D1
			±20%	GRM033R60J225ME47#	Mo
		4.7μF	±20%	GRM033R60J475ME05#	Mo D1
			±20%	GRM035R60J475ME15#	Mo D1
	B	1200pF	±5%	GRM033B10J122JA01#	
			±10%	GRM033B10J122KA01#	
		1500pF	±5%	GRM033B10J152JA01#	
			±10%	GRM033B10J152KA01#	
1800pF		±5%	GRM033B10J182JA01#		
		±10%	GRM033B10J182KA01#		
2200pF		±5%	GRM033B10J222JA01#		
		±10%	GRM033B10J222KA01#		
2700pF		±5%	GRM033B10J272JA01#		
		±10%	GRM033B10J272KA01#		
3300pF		±5%	GRM033B10J332JA01#		
		±10%	GRM033B10J332KA01#		
3900pF		±5%	GRM033B10J392JA01#		
		±10%	GRM033B10J392KA01#		
4700pF		±5%	GRM033B10J472JA01#		
		±10%	GRM033B10J472KA01#		
5600pF		±5%	GRM033B10J562JA01#		
		±10%	GRM033B10J562KA01#		
6800pF		±5%	GRM033B10J682JA01#		
		±10%	GRM033B10J682KA01#		
8200pF		±5%	GRM033B10J822JA01#		
		±10%	GRM033B10J822KA01#		
10000pF		±5%	GRM033B10J103JA01#		
		±10%	GRM033B10J103KA01#		
		±20%	GRM033B10J103MA01#		
12000pF		±10%	GRM033B10J123KE01#		
		±20%	GRM033B10J123ME01#		
15000pF		±10%	GRM033B10J153KE01#		
		±20%	GRM033B10J153ME01#		
18000pF		±10%	GRM033B10J183KE01#		
		±20%	GRM033B10J183ME01#		
22000pF		±10%	GRM033B10J223KE01#		
		±20%	GRM033B10J223ME01#		
27000pF		±10%	GRM033B10J273KE01#		
		±20%	GRM033B10J273ME01#		
33000pF		±10%	GRM033B10J333KE01#		
		±20%	GRM033B10J333ME01#		
39000pF		±10%	GRM033B30J393KE18#		
		±20%	GRM033B30J393ME18#		
47000pF		±10%	GRM033B30J473KE18#		
	±20%	GRM033B30J473ME18#			
56000pF	±10%	GRM033B30J563KE18#			
	±20%	GRM033B30J563ME18#			
68000pF	±10%	GRM033B30J683KE18#			
	±20%	GRM033B30J683ME18#			
82000pF	±10%	GRM033B30J823KE18#			
	±20%	GRM033B30J823ME18#			
0.10μF	±10%	GRM033B30J104KE18#			
	±20%	GRM033B30J104ME18#			

Rated Voltage	TC Code	Cap.	Tol.	Part Number	
6.3Vdc	B	0.22μF	±10%	GRM033B30J224KE15#	D1
			±20%	GRM033B30J224ME15#	D1
4Vdc	X7T	1.0μF	±20%	GRM033D70G105ME01#	
			±20%	GRM035D70G225ME01#	D1
	X6S	12000pF	±10%	GRM033C80G123KE01#	
			±20%	GRM033C80G123ME01#	
		15000pF	±10%	GRM033C80G153KE01#	
			±20%	GRM033C80G153ME01#	
		18000pF	±10%	GRM033C80G183KE01#	
			±20%	GRM033C80G183ME01#	
		22000pF	±10%	GRM033C80G223KE01#	
			±20%	GRM033C80G223ME01#	
		27000pF	±10%	GRM033C80G273KE01#	
			±20%	GRM033C80G273ME01#	
		33000pF	±10%	GRM033C80G333KE01#	
			±20%	GRM033C80G333ME01#	
		39000pF	±10%	GRM033C80G393KE01#	
			±20%	GRM033C80G393ME01#	
		47000pF	±10%	GRM033C80G473KE01#	
			±20%	GRM033C80G473ME01#	
		56000pF	±10%	GRM033C80G563KE19#	
			±20%	GRM033C80G563ME19#	
	68000pF	±10%	GRM033C80G683KE19#		
		±20%	GRM033C80G683ME19#		
	82000pF	±10%	GRM033C80G823KE19#		
		±20%	GRM033C80G823ME19#		
	0.10μF	±10%	GRM033C80G104KE19#		
		±20%	GRM033C80G104ME19#		
	0.22μF	±20%	GRM033C80G224ME15#	D1	
		±20%	GRM033C80G224ME90#		
	1.0μF	±20%	GRM033C80G105ME05#		
X6T	1.0μF	±20%	GRM032D80G105ME01#	Mo D1	
X5R	0.22μF	±20%	GRM033R60G224ME15#		
		±20%	GRM033R60G474ME90#	D1	
	1.0μF	±20%	GRM032R60G105ME05#	Mo	
		±20%	GRM033R60G105MEA2#		
	1.5μF	±20%	GRM033R60G155ME14#	Mo	
		±20%	GRM033R60G225ME44#	Mo	
4.7μF	±20%	GRM033R60G475ME05#	Mo		
	±20%	GRM035R60G475ME15#	Mo		
B	0.22μF	±20%	GRM033B30G224ME15#		
2.5Vdc	X7T	1.0μF	±20%	GRM033D70E105ME15#	
	X6S	0.22μF	±20%	GRM033C80E224ME15#	
			±20%	GRM033C80E475ME05#	Mo
X6T	2.2μF	±20%	GRM033D80E225ME47#	Mo	
X5R	4.7μF	±20%	GRM035R60E475ME01#		

1.0×0.5mm

Rated Voltage	TC Code	Cap.	Tol.	Part Number	
100Vdc	X7R	220pF	±10%	GRM155R72A221KA01#	
			±20%	GRM155R72A221MA01#	

Part number # indicates the package specification code.

GRM Series High Dielectric Constant Type Part Number List

(→ 1.0×0.5mm)

Rated Voltage	TC Code	Cap.	Tol.	Part Number		Rated Voltage	TC Code	Cap.	Tol.	Part Number	
100Vdc	X7R	470pF	±10%	GRM155R72A471KA01#		35Vdc	X5R	1.0μF	±20%	GRM155R6YA105ME11#	D1
			±20%	GRM155R72A471MA01#				2.2μF	±10%	GRM155R6YA225KE11#	Mo D1
		1000pF	±10%	GRM155R72A102KA01#				±20%	GRM155R6YA225ME11#	Mo D1	
			±20%	GRM155R72A102MA01#				25Vdc	X7R	2200pF	±5%
		±10%	GRM155R72A222KA01#		±10%		GRM155R71E223KA61#				
		±20%	GRM155R72A222MA01#		±20%		GRM155R71E223MA61#				
		4700pF	±10%	GRM155R72A472KA01#			4700pF				±5%
			±20%	GRM155R72A472MA01#				±10%		GRM155R71E473KA88#	
		X5R	0.10μF	±10%	GRM155R62A104KE14#	D1	±20%	GRM155R71E473MA88#			
				±20%	GRM155R62A104ME14#	D1	0.10μF	±10%		GRM155R71E104KE14#	
				±10%	GRM155R71H222JA01#			±20%		GRM155R71E104ME14#	
				±10%	GRM155R71H222KA01#		X6S	1.0μF	±10%	GRM155C81E105KE11#	D1
	±20%	GRM155R71H222MA01#		±20%	GRM155C81E105ME11#	D1					
			4700pF	±5%	GRM155R71H472JA01#		2.2μF	±10%	GRM155C81E225KE11#	Mo D1	
±10%				GRM155R71H472KA01#		±20%	GRM155C81E225ME11#	Mo D1			
			±20%	GRM155R71H472MA01#		X6T	2.2μF	±20%	GRM155D81E225ME11#	D1	
			±5%	GRM155R71H103JA88#				X5R	1.0μF	±10%	GRM155R61E105KA12#
		10000pF	±10%	GRM155R71H103KA88#		±10%	GRM155R61E105KE11#				
			±20%	GRM155R71H103MA88#		±20%	GRM155R61E105MA12#	D1			
		22000pF	±5%	GRM155R71H223JA12#			2.2μF	±10%	GRM155R61E225KE11#		
			±10%	GRM155R71H223KA12#				±20%	GRM155R61E225ME11#		
			±20%	GRM155R71H223MA12#		±20%	GRM155R61E225ME15#	D1			
			47000pF	±10%	GRM155R71H473KE14#		B	1.0μF	±10%	GRM155B31E105KA12#	D1
±20%	GRM155R71H473ME14#			±20%	GRM155B31E105MA12#	D1					
		0.10μF	±10%	GRM155R71H104KE14#		16Vdc	X7R	2200pF	±5%	GRM155R71C223JA01#	
			±20%	GRM155R71H104ME14#					±10%	GRM155R71C223KA01#	
±5%	GRM155C71H473JE19#		±20%	GRM155R71C223MA01#							
47000pF	±10%	GRM155C71H473KE19#		47000pF	±5%			GRM155R71C473JA01#			
	±20%	GRM155C71H473ME19#			±10%			GRM155R71C473KA01#			
	±5%	GRM155C71H104JE19#			±20%			GRM155R71C473MA01#			
		0.10μF	±10%	GRM155C71H104KE19#			0.22μF	±10%	GRM155R71C224KA12#		
			±20%	GRM155C71H104ME19#				±20%	GRM155R71C224MA12#		
			±5%	GRM155R11H222JA01#				X7S	1.0μF	±10%	GRM155C71C105KE11#
±10%	GRM155R11H222KA01#		±20%	GRM155C71C105ME11#							
		2200pF	±20%	GRM155R11H222MA01#			X7T	2.2μF	±20%	GRM155D71C225ME11#	D1
			±5%	GRM155R11H472JA01#					R	2200pF	±5%
±10%	GRM155R11H472KA01#		±10%	GRM155R11C223KA01#							
±20%	GRM155R11H472MA01#		±20%	GRM155R11C223MA01#							
10000pF			±5%	GRM155R11H103JA88#		47000pF	±5%	GRM155R11C473JA01#			
			±10%	GRM155R11H103KA88#			±10%	GRM155R11C473KA01#			
			±20%	GRM155R11H103MA88#			±20%	GRM155R11C473MA01#			
X5R		0.10μF	±10%	GRM155R61H104KE14#		X6S	1.0μF	±10%	GRM155C81C105KE11#		
			±10%	GRM155R61H104KE19#				±10%	GRM155C81C105KE15#	D1	
			±20%	GRM155R61H104ME14#				±20%	GRM155C81C105ME11#		
			±20%	GRM155R61H104ME19#				±20%	GRM155C81C105ME15#	D1	
		0.47μF	±10%	GRM155R61H474KE11#	D1		2.2μF	±10%	GRM155C81C225KE11#		
			±20%	GRM155R61H474ME11#	D1			±20%	GRM155C81C225ME11#		
		1.0μF	±10%	GRM155R61H105KE05#	Mo D1			±20%	GRM155C81C225ME15#	D1	
			±20%	GRM155R61H105ME05#	Mo D1			X6T	2.2μF	±20%	GRM155D81C225ME11#
	B	0.10μF	±10%	GRM155B31H104KE14#		X5R	1.0μF			±10%	GRM155R61C105KA12#
			±20%	GRM155B31H104ME14#				±20%	GRM155R61C105MA12#		
35Vdc	X6S	0.22μF	±10%	GRM155C8YA224KE01#	D1		2.2μF	±10%	GRM155R61C225KE11#		
			±20%	GRM155C8YA224ME01#	D1			±10%	GRM155R61C225KE44#	D1	
	X5R	1.0μF	±10%	GRM155R6YA105KE11#	D1		±20%	GRM155R61C225ME11#			

Part number # indicates the package specification code.

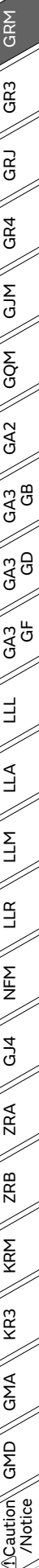

GRM Series High Dielectric Constant Type Part Number List

(→ 1.0×0.5mm)

Rated Voltage	TC Code	Cap.	Tol.	Part Number		Rated Voltage	TC Code	Cap.	Tol.	Part Number				
16Vdc	X5R	2.2μF	±20%	GRM155R61C225ME15#		6.3Vdc	X6S	2.2μF	±20%	GRM155C80J225ME95#	D1			
			±20%	GRM155R61C225ME44#	D1			4.7μF	±20%	GRM155C80J475MEAA#	D1			
	B	1.0μF	±10%	GRM155B31C105KA12#			X6T	1.0μF	±20%	GRM153D80J105ME95#	D1			
			±20%	GRM155B31C105MA12#				2.2μF	±10%	GRM155D80J225KE95#	D1			
10Vdc	X7R	47000pF	±5%	GRM155R71A473JA01#			±20%	GRM155D80J225ME95#	D1	X5R	1.0μF	±20%	GRM152R60J105ME15#	D1
			±10%	GRM155R71A473KA01#				±20%	GRM153R60J105ME15#		D1	±20%	GRM152R60J225KE01#	
			±20%	GRM155R71A473MA01#			2.2μF	±10%	GRM155R60J225KE01#			±20%	GRM152R60J225ME05#	Mo D1
		±10%	GRM155R71A224KE01#		±20%		GRM155R71A224ME01#		±20%		GRM153R60J225ME95#	D1		
		0.22μF	±10%	GRM155R71A224KE01#			±20%	GRM155R71A474KE01#			±20%	GRM155R60J225ME01#		
			±20%	GRM155R71A474ME01#			X7S	1.0μF	±10%		GRM155C71A105KE11#		4.7μF	±20%
	0.47μF	±10%	GRM155R71A474KE01#		±20%				GRM155C71A105ME11#		±20%	GRM155R60J475ME47#		D1
		±20%	GRM155R71A474ME01#		±10%		GRM155C71A225KE11#		±20%	GRM155R60J475ME87#	D1			
	X7T	2.2μF	±10%	GRM155D71A225KE11#		±20%	GRM155C71A225ME11#		±20%	GRM155R60J106ME05#	D1			
			±20%	GRM155D71A225ME11#		X7T	2.2μF	±10%	GRM155D71A225KE11#		±20%	GRM155R60J106ME15#		Mo D1
			±20%	GRM155D71A225ME15#	D1			±20%	GRM155R60J106ME47#	Mo D1				
	R	47000pF	±5%	GRM155R11A473JA01#				±20%	GRM155D71A225ME15#	D1	±20%	GRM155R60J156ME05#	Mo D1	
			±10%	GRM155R11A473KA01#		X6S	1.0μF	±10%	GRM155C81A105KA12#		±20%	GRM158R60J226ME01#	Mo	
			±20%	GRM155R11A473MA01#				±10%	GRM155C81A105MA12#		±20%	GRM153B30J105ME15#	D1	
	±10%	GRM155C81A225KE11#		±20%	GRM155C81A225KE44#			D1	±20%	GRM153B30J225ME95#	D1			
	6.3Vdc	X6S	1.0μF	±10%	GRM155C81A105KA12#		±20%	GRM155C81A225ME11#		±20%	GRM155R60J106ME47#	D1		
				±20%	GRM155C81A105MA12#		±20%	GRM155C81A225ME15#		±20%	GRM155R60J106ME15#	Mo D1		
				±10%	GRM155C81A225KE11#		±20%	GRM155C81A225ME44#	D1	±20%	GRM155R60J106ME47#	Mo D1		
			2.2μF	±10%	GRM155C81A225KE11#		±20%	GRM155C81A225ME15#		±20%	GRM155R60J156ME05#	Mo D1		
				±10%	GRM155C81A225KE44#	D1	±20%	GRM155C81A225ME44#	D1	±20%	GRM158R60J226ME01#	Mo		
±20%				GRM155C81A225ME11#		X5R	1.0μF	±20%	GRM153R61A105ME95#	D1	±20%	GRM153B30J105ME15#	D1	
X5R		2.2μF	±10%	GRM155R61A225KE01#	D1			±20%	GRM155R61A225ME01#	D1	±20%	GRM153B30J225ME95#	D1	
			±20%	GRM155R61A225ME01#	D1			±10%	GRM155R61A475MEAA#	D1	±20%	GRM155B30J475ME47#	D1	
			±20%	GRM155R61A475MEAA#	D1	±20%	GRM155R61A106ME11#	Mo D1	±20%	GRM155B30J475ME87#	D1			
4.7μF		±20%	GRM155R61A475MEAA#	D1	±20%	GRM158R61A226ME15#	Mo D1	X6T	1.0μF	±20%	GRM152D80G105ME15#	D1		
		10μF	±20%	GRM155R61A106ME11#	Mo D1	±20%	GRM155R61A226ME15#			Mo D1	±20%	GRM153D80G105ME95#		
			±20%	GRM158R61A226ME15#	Mo D1	±20%	GRM155R61A106ME11#			Mo D1	±20%	GRM155D80G225KE95#		
B	1.0μF		±20%	GRM153B31A105ME95#	D1	B	1.0μF	±20%	GRM153B31A105ME95#	D1	±20%	GRM155D80G225ME95#		
		±20%	GRM155B31A225KE95#	D1	±20%			GRM155B31A225ME95#	D1	±20%	GRM155D80G225ME95#			
		±20%	GRM155B31A225ME95#	D1	±20%			GRM155B31A225ME95#	D1	±20%	GRM155R60G105ME15#			
X7R	1.0μF	±10%	GRM155Z71A105KE01#		X7R	1.0μF	±10%	GRM155Z71A105KE01#		X5R	1.0μF	±20%	GRM152R60G105ME15#	
		±10%	GRM155Z71A225KE01#				±10%	GRM155Z71A225KE01#				±20%	GRM153R60G105ME19#	
		±20%	GRM155Z71A225ME43#	D1			±20%	GRM155Z71A225ME44#				±20%	GRM153R60G225ME95#	
	2.2μF	±10%	GRM155Z71A225KE01#		±10%	GRM155Z71A225KE44#		±20%	GRM155R60G225ME15#					
		±10%	GRM155Z71A225KE44#		±20%	GRM155Z71A225ME43#	D1	±20%	GRM153R60G475ME15#		Mo			
		±20%	GRM155Z71A225ME43#	D1	X7S	1.0μF	±10%	GRM155C70J105KE11#			±20%	GRM155R60G475ME47#		
X7S	2.2μF	±10%	GRM155C70J225KE11#				±20%	GRM155C70J105ME11#		±20%	GRM155R60G475ME87#			
		±20%	GRM155C70J225ME11#				±20%	GRM155C70J225ME11#		±20%	GRM155R60G475ME87#			
		±20%	GRM155C70J225ME11#		±20%	GRM155C70J225ME11#		±20%	GRM155R60G106ME01#					
X7T	2.2μF	±20%	GRM155D70J225ME44#	D1	X7T	2.2μF	±20%	GRM155D70J225ME44#	D1	B	1.0μF	±20%	GRM153B30G105ME19#	
		±20%	GRM155D70J225ME44#	D1			±20%	GRM155D70J225ME44#	D1			±20%	GRM153B30G225ME95#	
	X6S	0.47μF	±10%	GRM155C80J474KE19#		±20%	GRM155D70J225ME44#	D1	±20%		GRM155B30G225ME15#			
			±20%	GRM155C80J474ME19#		±20%	GRM155D70J225ME44#	D1	±20%		GRM155B30G475ME47#			
±20%	GRM155C80J474ME19#		±20%	GRM155C80J474ME19#		±20%	GRM155D70J225ME44#	D1	±20%	GRM155B30G475ME87#				
±20%	GRM155C80J225KE95#	D1	±20%	GRM155C80J225KE95#	D1	2.5Vdc	X6S	2.2μF	±20%	GRM155C80E225ME15#				
±20%	GRM155C80J105KA12#		±20%	GRM155C80E225ME15#				10μF	±20%	GRM155C80E106ME44#	Mo			
±20%	GRM155C80J105KA12#		±20%	GRM155C80E106ME44#	Mo			22μF	±20%	GRM155C80E226ME11#	Mo D1			

Part number # indicates the package specification code.

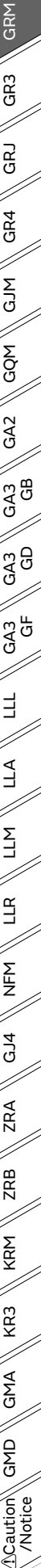

GRM Series High Dielectric Constant Type Part Number List

(→ 1.0×0.5mm)

Rated Voltage	TC Code	Cap.	Tol.	Part Number	
2.5Vdc	X6T	2.2μF	±20%	GRM152D80E225ME01#	Mo D1
		4.7μF	±20%	GRM155D80E475ME47#	D1
	X5R	4.7μF	±20%	GRM155R60E475ME76#	
		10μF	±20%	GRM155R60E106ME16#	
	X5S	10μF	±20%	GRM155C60E106ME16#	

1.6×0.8mm

Rated Voltage	TC Code	Cap.	Tol.	Part Number	
100Vdc	X7R	10000pF	±10%	GRM188R72A103KA01#	
			±20%	GRM188R72A103MA01#	
		22000pF	±5%	GRM188R72A223JAC4#	
			±10%	GRM188R72A223KAC4#	
			±20%	GRM188R72A223MAC4#	
		0.10μF	±10%	GRM188R72A104KA35#	
			±20%	GRM188R72A104MA35#	
50Vdc	X7R	0.22μF	±10%	GRM188R71H224KAC4#	
			±20%	GRM188R71H224MAC4#	
	X5R	2.2μF	±10%	GRM188R61H225KE11#	
			±20%	GRM188R61H225ME11#	
35Vdc	X7R	0.47μF	±10%	GRM188R7YA474KE05#	
			±20%	GRM188R7YA474ME05#	
	X6S	2.2μF	±10%	GRM188C8YA225KE11#	
			±20%	GRM188C8YA225ME11#	
	X5R	2.2μF	±10%	GRM188R6YA225KA12#	D1
			±20%	GRM188R6YA225MA12#	D1
			4.7μF	±10%	GRM188R6YA475KE15#
	10μF	±10%	GRM188R6YA475ME15#		
		±20%	GRM188R6YA106MA73#	Mo D1	
	B	2.2μF	±10%	GRM188B3YA225KA12#	D1
±20%			GRM188B3YA225MA12#	D1	
25Vdc	X7R	0.22μF	±5%	GRM188R71E224JA88#	
			±10%	GRM188R71E224KA88#	
			±20%	GRM188R71E224MA88#	
		0.47μF	±10%	GRM188R71E474KA12#	
			±20%	GRM188R71E474MA12#	
	X7S	2.2μF	±10%	GRM188C71E225KE11#	
			±20%	GRM188C71E225ME11#	
	X6S	2.2μF	±10%	GRM188C81E225KE11#	
			±20%	GRM188C81E225ME11#	
			4.7μF	±10%	GRM188C81E475KE11#
	±20%	GRM188C81E475ME11#	D1		
		X5R	2.2μF	±10%	GRM188R61E225KA12#
	±20%			GRM188R61E225MA12#	
	4.7μF			±10%	GRM188R61E475KE11#
	±20%	GRM188R61E475ME11#			
10μF		±10%	GRM188R61E106KA73#		
	±20%	GRM188R61E106MA73#			
	B	2.2μF	±10%	GRM188B31E225KA12#	
±20%			GRM188B31E225MA12#		
X7R	2.2μF	±10%	GRM188Z71E225KE43#		
		±20%	GRM188Z71E225ME43#		
16Vdc	X7R	0.47μF	±10%	GRM188R71C474KA88#	

Rated Voltage	TC Code	Cap.	Tol.	Part Number		
16Vdc	X7R	0.47μF	±20%	GRM188R71C474MA88#		
			±10%	GRM188C71C225KE11#		
	X7S	2.2μF	±10%	GRM188C71C225KE11#		
			±20%	GRM188C71C225ME11#		
			4.7μF	±10%	GRM188C71C475KE21#	
				±20%	GRM188C71C475ME21#	
	X6S	2.2μF	±10%	GRM188C81C225KA12#		
			±20%	GRM188C81C225MA12#		
		4.7μF	±10%	GRM188C81C475KE11#		
			±20%	GRM188C81C475ME11#		
			10μF	±20%	GRM188C81C106MA73#	
	X5R	4.7μF	±10%	GRM185R61C475KE11#		
			±10%	GRM188R61C475KE11#		
			±20%	GRM185R61C475ME11#		
		10μF	±20%	GRM188R61C106MA73#		
±20%			GRM188R61C106MAAL#			
B	4.7μF	±10%	GRM188B31C475KAAJ#	D1		
		±20%	GRM188B31C475MAAJ#	D1		
X7R	2.2μF	±10%	GRM188Z71C225KE43#			
		±20%	GRM188Z71C225ME43#			
	4.7μF	±10%	GRM188Z71C475KE21#			
±20%		GRM188Z71C475ME21#				
10Vdc	X7R	2.2μF	±10%	GRM188R71A225KE15#		
			±20%	GRM188R71A225ME15#		
	X7S	4.7μF	±10%	GRM188C71A475KE11#		
			±20%	GRM188C71A475ME11#		
	X7T	4.7μF	±10%	GRM188D71A475KE11#		
			±20%	GRM188D71A475ME11#		
			10μF	±10%	GRM188D71A106KA73#	
	±20%	GRM188D71A106MA73#				
	X6S	4.7μF	±10%	GRM185C81A475KE11#	D1	
			±20%	GRM185C81A475ME11#	D1	
		10μF	±10%	GRM188C81A106KA73#		
			±20%	GRM188C81A106MA73#		
			±20%	GRM188C81A106MA73#		
	X5R	10μF	±20%	GRM188R61A106MAAL#		
			±20%	GRM188R61A106ME69#	D1	
22μF		±20%	GRM187R61A226ME15#	Mo D1		
±20%	GRM188R61A226ME15#	D1				
	B	10μF	±10%	GRM188B31A106KE69#	D1	
±20%			GRM188B31A106ME69#	D1		
X7R	4.7μF	±10%	GRM188Z71A475KE15#			
		±20%	GRM188Z71A475ME15#			
		10μF	±10%	GRM188Z71A106KA73#		
±20%	GRM188Z71A106MA73#					
6.3Vdc	X7R	2.2μF	±10%	GRM188R70J225KE15#		
X7S	2.2μF	±10%	GRM188C70J225KE20#			
		±20%	GRM188C70J225ME20#			
X7T	4.7μF	±20%	GRM185D70J475ME11#	D1		
		10μF	±20%	GRM188D70J106MA73#		
X6S	4.7μF	±20%	GRM185C80J475ME11#			
		10μF	±20%	GRM188C80J106MA73#		
		±20%	GRM188C80J106MEA6#	Mo D1		
22μF	±20%	GRM188C80J226ME15#	D1			
	X5R	10μF	±10%	GRM188R60J106KE47#		

Part number # indicates the package specification code.

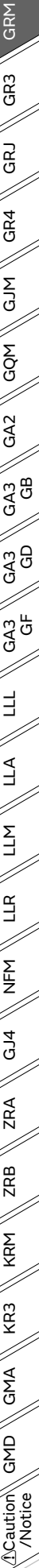

GRM Series High Dielectric Constant Type Part Number List

(→ 1.6×0.8mm)

Rated Voltage	TC Code	Cap.	Tol.	Part Number	
6.3Vdc	X5R	10μF	±20%	GRM185R60J106ME15#	D1
			±20%	GRM188R60J106ME47#	
		22μF	±20%	GRM186R60J226ME15#	Mo D1
			±20%	GRM187R60J226ME15#	Mo
			±20%	GRM188R60J226ME15#	
			±20%	GRM188R60J226MEA0#	D1
	47μF	±20%	GRM188R60J476ME15#	Mo D1	
		B	10μF	±20%	GRM188B30J106ME47#
	22μF		±20%	GRM188B30J226MEA0#	D1
	4Vdc	X7S	2.2μF	±10%	GRM188C70G225KE20#
±20%				GRM188C70G225ME20#	
X6S		10μF	±20%	GRM188C80G106ME47#	D1
			±20%	GRM188C80G106ME69#	
		22μF	±20%	GRM188C80G226ME15#	
			±20%	GRM188C80G476ME01#	Mo D1
X5R		10μF	±20%	GRM185R60G106ME15#	
			±20%	GRM188R60G106ME47#	
		22μF	±20%	GRM186R60G226ME15#	Mo
			±20%	GRM188R60G226MEA0#	
47μF		±20%	GRM188R60G476ME15#	Mo	
		B	10μF	±20%	GRM188B30G106ME46#
22μF			±20%	GRM188B30G226MEA0#	
2.5Vdc		X6S	10μF	±10%	GRM188C80E106KE47#
	±20%			GRM188C80E106ME47#	
	47μF		±20%	GRM188C80E476ME05#	
	X5R	47μF	±20%	GRM188R60E476ME15#	Mo

1.8×1.0mm

Rated Voltage	TC Code	Cap.	Tol.	Part Number	
16Vdc	X5R	20μF	±20%	GRMJN7R61C206ME05#	Mo D1
		22μF	±20%	GRMJN7R61C226ME05#	Mo D1
6.3Vdc	X5R	43μF	±20%	GRMJN7R60J436ME05#	Mo D1

2.0×1.25mm

Rated Voltage	TC Code	Cap.	Tol.	Part Number		
100Vdc	X7R	47000pF	±5%	GRM21BR72A473JA01#		
			±10%	GRM21BR72A473KA01#		
			±20%	GRM21BR72A473MA01#		
		0.22μF	±10%	GRM21AR72A224KAC5#		
			±20%	GRM21AR72A224MAC5#		
			0.47μF	±10%	GRM21BR72A474KA73#	
	±20%	GRM21BR72A474MA73#				
	X7S	1.0μF	±10%	GRM21BC72A105KE01#		
	50Vdc	X7R	0.47μF	±10%	GRM21BR71H474KA88#	
				±20%	GRM21BR71H474MA88#	
X7S		4.7μF	±10%	GRM21BC71H475KE11#		
			±20%	GRM21BC71H475ME11#		
X6S		4.7μF	±10%	GRM21BC81H475KE11#		
			±20%	GRM21BC81H475ME11#		
X5R		4.7μF	±10%	GRM21BR61H475KE51#		

Rated Voltage	TC Code	Cap.	Tol.	Part Number			
50Vdc	X5R	4.7μF	±20%	GRM21BR61H475ME51#			
			±10%	GRM21BR61H106KE43#	Mo D1		
		10μF	±20%	GRM21BR61H106ME43#	Mo D1		
			±10%	GRM21BR61H106ME43#	Mo D1		
			B	4.7μF	±10%	GRM21BB31H475KE51#	
				±20%	GRM21BB31H475ME51#		
	X7R	4.7μF	±10%	GRM21BZ71H475KE15#			
			±20%	GRM21BZ71H475ME15#			
	35Vdc	X7R	1.0μF	±10%	GRM219R7YA105KA12#	D1	
				±20%	GRM219R7YA105MA12#	D1	
X7S		4.7μF	±10%	GRM21BC7YA475KE11#			
			±20%	GRM21BC7YA475ME11#			
			X6S	4.7μF	±10%	GRM219C8YA475KE21#	D1
±10%		GRM21BC8YA475KE51#					
±20%		GRM219C8YA475ME21#		D1			
		±20%		GRM21BC8YA475ME51#			
10μF		±10%	GRM21BC8YA106KE11#	D1			
		±20%	GRM21BC8YA106ME11#	D1			
		X5R	4.7μF	±10%	GRM219R6YA475KA73#	D1	
				±20%	GRM219R6YA475MA73#	D1	
10μF		±10%	GRM21BR6YA106KE43#	D1			
		±20%	GRM21BR6YA106ME43#	D1			
X7R	4.7μF	±10%	GRM21BZ7YA475KE15#				
		±20%	GRM21BZ7YA475ME15#				
25Vdc	X7R	2.2μF	±10%	GRM21BR71E225KE11#			
			±20%	GRM21BR71E225ME11#			
	X7S	2.2μF	±10%	GRM21BC71E225KE11#			
			±20%	GRM21BC71E225ME11#			
		4.7μF	±10%	GRM219C71E475KE21#	D1		
			±10%	GRM21BC71E475KE11#			
	±20%	GRM219C71E475ME21#	D1				
		±20%	GRM21BC71E475ME11#				
	10μF	±10%	GRM21BC71E106KE11#	D1			
		±20%	GRM21BC71E106ME11#	D1			
		X6S	4.7μF	±10%	GRM219C81E475KE21#	D1	
				±20%	GRM219C81E475ME21#	D1	
	10μF	±10%	GRM21BC81E106KE51#	D1			
		±20%	GRM21BC81E106ME51#	D1			
X5R	4.7μF	±10%	GRM219R61E475KA73#				
		±20%	GRM219R61E475MA73#				
	10μF	±10%	GRM21BR61E106KA73#				
		±20%	GRM21BR61E106MA73#				
	22μF	±20%	GRM21BR61E226ME44#				
		B	10μF	±10%	GRM21BB31E106KA73#		
±20%	GRM21BB31E106MA73#						
X7R	4.7μF	±10%	GRM21BZ71E475KE15#				
		±20%	GRM21BZ71E475ME15#				
10μF	±10%	GRM21BZ71E106KE15#	D1				
	16Vdc	X7R	4.7μF	±10%	GRM21BR71C475KE51#		
±20%				GRM21BR71C475ME51#			
X7S		4.7μF	±10%	GRM219C71C475KE21#			
			±20%	GRM219C71C475ME21#			
10μF	±10%	GRM21BC71C106KE11#					
	±20%	GRM21BC71C106ME11#					
X6S	4.7μF	±10%	GRM219C81C475KA73#				

Part number # indicates the package specification code.

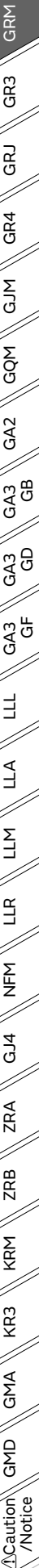

GRM Series High Dielectric Constant Type Part Number List

(→ 2.0×1.25mm)

Rated Voltage	TC Code	Cap.	Tol.	Part Number		
16Vdc	X6S	4.7μF	±20%	GRM219C81C475MA73#		
			±10%	GRM21BC81C106KA73#		
		10μF	±10%	GRM21BC81C106KE15#	D1	
			±20%	GRM21BC81C106MA73#		
			±20%	GRM21BC81C106ME15#	D1	
			±20%	GRM21BC81C226ME44#	D1	
			±20%	GRM21BC81C226ME44#	D1	
		X5R	10μF	±10%	GRM21BR61C106KE15#	
				±20%	GRM21BR61C106ME15#	
		22μF	±20%	GRM219R61C226ME15#	D1	
	±20%		GRM21BR61C226ME44#			
	B	10μF	±10%	GRM21BB31C106KE15#		
			±20%	GRM21BB31C106ME15#		
	X7R	10μF	±10%	GRM21BZ71C106KE15#		
			±20%	GRM21BZ71C106ME15#		
	10Vdc	X7R	4.7μF	±10%	GRM21BR71A475KE51#	
				±20%	GRM21BR71A475ME51#	
			10μF	±10%	GRM21BR71A106KA73#	D1
				±20%	GRM21BR71A106MA73#	D1
		X7T	22μF	±20%	GRM21BD71A226ME44#	D1
		X6S	10μF	±10%	GRM21BC81A106KE18#	
±20%				GRM21BC81A106ME18#		
22μF		±20%	GRM21BC81A226ME44#			
		±20%	GRM21BR61A226ME44#			
X5R		22μF	±20%	GRM21BR61A226ME51#	D1	
			±20%	GRM21BR61A476ME15#	D1	
X7R		22μF	±20%	GRM21BZ71A226ME15#	D1	
6.3Vdc		X7R	10μF	±10%	GRM21BR70J106KA73#	
				±20%	GRM21BR70J106MA73#	
	X7T	22μF	±20%	GRM21BD70J226ME44#		
	X5R	22μF	±20%	GRM21BR60J226ME39#		
			±20%	GRM219R60J476ME44#	Mo D1	
		±20%	GRM21BR60J476ME01#	D1		
		±20%	GRM21BR60J476ME11#			
	100μF	±20%	GRM21BR60J107ME15#	D1		
	B	47μF	±20%	GRM21BB30J476ME15#	D1	
	X7R	22μF	±20%	GRM21BZ70J226ME44#		
4Vdc	X7U	22μF	±20%	GRM21BE70G226ME51#		
			±20%	GRM21BC80G476ME15#	D1	
	100μF	±20%	GRM21BC80G107ME15#	D1		
	X6T	47μF	±20%	GRM21BD80G476ME01#	D1	
	X5R	47μF	±20%	GRM219R60G476ME44#	D1	
			±20%	GRM21BR60G476ME01#		
	100μF	±20%	GRM21BR60G107ME11#			
	B	47μF	±20%	GRM21BB30G476ME15#		
2.5Vdc	X6S	100μF	±20%	GRM21BC80E107ME15#		
			±20%	GRM219D80E476ME44#		
	X5R	100μF	±20%	GRM21BR60E107ME15#		

3.2×1.6mm

Rated Voltage	TC Code	Cap.	Tol.	Part Number	
100Vdc	X7S	4.7μF	±10%	GRM31CC72A475KE11#	
			±20%	GRM31CC72A475ME11#	

Rated Voltage	TC Code	Cap.	Tol.	Part Number		
100Vdc	X7R	4.7μF	±10%	GRM31CZ72A475KE11#		
			±20%	GRM31CZ72A475ME11#		
50Vdc	X7R	4.7μF	±10%	GRM31CR71H475KA12#		
			±20%	GRM31CR71H475MA12#		
		X7T	10μF	±10%	GRM31CD71H106KE11#	
				±20%	GRM319R61H475KA12#	
				±20%	GRM319R61H475MA12#	
	X5R	4.7μF	±10%	GRM319R61H475KA12#		
			±20%	GRM319R61H475MA12#		
	B	4.7μF	±10%	GRM319B31H475KA12#		
			±20%	GRM319B31H475MA12#		
	35Vdc	X7T	10μF	±10%	GRM31CD7YA106KE11#	
25Vdc	X7R	10μF	±10%	GRM31CR71E106KA12#		
			±20%	GRM31CR71E106MA12#		
			±20%	GRM31CR71E106ME15#		
		X7S	22μF	±20%	GRM31CC71E226ME15#	
				±20%	GRM31CC81E106KA12#	
	X6S	10μF	±10%	GRM31CC81E106MA12#		
			±20%	GRM31CC81E226KE11#		
	±20%	GRM31CC81E226ME11#				
	16Vdc	X7S	22μF	±20%	GRM31CC71C226ME11#	
				±20%	GRM319R61C226KE15#	D1
X5R		22μF	±10%	GRM319R61C226ME15#	D1	
			±20%	GRM319R61C226ME15#	D1	
			±20%	GRM31CR61C476ME44#		
B		22μF	±20%	GRM319B31C226ME15#	D1	
X7R		22μF	±20%	GRM31CZ71C226ME15#		
10Vdc	X7R	22μF	±10%	GRM31CR71A226KE15#		
			±20%	GRM31CR71A226ME15#		
	X6S	47μF	±20%	GRM31CC81A476ME44#		
			±20%	GRM31CR61A476KE15#		
	X5R	47μF	±10%	GRM31CR61A476ME15#		
			±20%	GRM31CR61A476ME15#		
	100μF	±20%	GRM31CR61A107MEA8#	D1		
	6.3Vdc	X7R	22μF	±10%	GRM31CR70J226KE19#	
±20%				GRM31CR70J226ME19#		
X7S		22μF	±10%	GRM31CC70J226KE15#	D1	
			±20%	GRM31CE70J476ME15#	D1	
X7U		47μF	±20%	GRM31CE70G476ME15#	D1	
X6T		100μF	±20%	GRM31CD80J107MEA8#	D1	
			±20%	GRM31CR60J476KE19#		
4Vdc	X7S	22μF	±10%	GRM31CC70G226KE01#		
			±20%	GRM31CC70G226ME01#		
	X7U	47μF	±20%	GRM31CE70G476ME15#		
			±20%	GRM31CE70G107MEA8#	D1	
	X6S	220μF	±20%	GRM31CC80G227ME11#	Mo D1	
2.5Vdc	X6T	47μF	±20%	GRM31CD80G476ME19#		
			±20%	GRM31CD80G107MEA8#		
	X5R	100μF	±20%	GRM31CR60G107MEA8#		
			±20%	GRM31CR60G227ME11#		
X6S	220μF	±20%	GRM31CC80E227ME11#			
X5R	220μF	±20%	GRM31CR60E227ME11#			

GRM
 GR3
 GRJ
 GR4
 GJM
 GQM
 GA2
 GA3 GB
 GA3 GD
 GA3 GF
 LLL
 LLA
 LLM
 LLR
 NFM
 GJ4
 ZRA
 ZRB
 KRM
 KR3
 GMA
 GMD
 ⚠Caution /Notice

Part number # indicates the package specification code.

GRM Series High Dielectric Constant Type Part Number List

3.2×2.5mm

Rated Voltage	TC Code	Cap.	Tol.	Part Number	
100Vdc	X7S	10μF	±10%	GRM32EC72A106KE05#	
			±20%	GRM32EC72A106ME05#	
25Vdc	X7R	22μF	±10%	GRM32ER71E226KE15#	
			±20%	GRM32ER71E226ME15#	
	X6S	22μF	±10%	GRM32EC81E226KE15#	
			±20%	GRM32EC81E226ME15#	
16Vdc	X7R	22μF	±10%	GRM32ER71C226KEA8#	
			±20%	GRM32ER71C226MEA8#	
	X6S	47μF	±10%	GRM32EC81C476KE15#	D1
			±20%	GRM32EC81C476ME15#	D1
10Vdc	X7R	47μF	±10%	GRM32ER71A476KE15#	
			±20%	GRM32ER71A476ME15#	
	X7T	47μF	±10%	GRM32ED71A476KE15#	D1
			±20%	GRM32ED71A476ME15#	D1
	X6S	47μF	±10%	GRM32EC81A476KE19#	
			±20%	GRM32EC81A476ME19#	
	X5R	100μF	±20%	GRM32ER61A107ME20#	D1
6.3Vdc	X7R	47μF	±10%	GRM32ER70J476KE20#	
			±20%	GRM32ER70J476ME20#	
	X7S	100μF	±20%	GRM32EC70J107ME15#	D1
	X7U	100μF	±20%	GRM32EE70J107ME15#	D1
	X5R	220μF	±20%	GRM32ER60J227ME05#	
4Vdc	X7S	100μF	±20%	GRM32EC70G107ME15#	
			±20%	GRM32EE70G107ME19#	
	X6S	220μF	±20%	GRM32EC80G227ME05#	
			±20%	GRM32ER60G227ME05#	
	X5R	330μF	±20%	GRM32ER60G337ME05#	
2.5Vdc	X6S	220μF	±20%	GRM32EC80E227ME05#	
			±20%	GRM32EC80E337ME05#	
	X5R	330μF	±20%	GRM32ER60E337ME05#	

4.5×3.2mm

Rated Voltage	TC Code	Cap.	Tol.	Part Number	
1250Vdc	X7R	33000pF	±10%	GRM43DR7LX333KW01#	D6
			±10%	GRM43DR7LX473KW01#	D6
1000Vdc	X7R	33000pF	±10%	GRM43DR73A333KW01#	
			±10%	GRM43DR73A473KW01#	
		68000pF	±10%	GRM43QR7LW683KW01#	D6
			±10%	GRM43DR7LW104KW01#	D6
630Vdc	X7R	68000pF	±10%	GRM43QR72J683KW01#	
			±10%	GRM43DR72J104KW01#	
500Vdc	X7R	0.15μF	±10%	GRM43QR72H154KW10#	
			±10%	GRM43DR72H224KW10#	
250Vdc	X7R	0.15μF	±10%	GRM43QR72E154KW01#	
			±10%	GRM43DR72E224KW01#	
		0.33μF	±10%	GRM43DR72E334KW01#	
			±10%	GRM43DR72E474KW01#	

5.7×5.0mm

Rated Voltage	TC Code	Cap.	Tol.	Part Number	
1250Vdc	X7R	68000pF	±10%	GRM55DR7LX683KW01#	D6
			±10%	GRM55DR7LX104KW01#	D6
1000Vdc	X7R	68000pF	±10%	GRM55DR73A683KW01#	
			±10%	GRM55DR73A104KW01#	
		0.15μF	±10%	GRM55DR7LW154KW01#	D6
			±10%	GRM55DR7LW224KW01#	D6
630Vdc	X7R	0.15μF	±10%	GRM55DR72J154KW01#	
			±10%	GRM55DR72J224KW01#	
500Vdc	X7R	0.33μF	±10%	GRM55DR72H334KW10#	
			±10%	GRM55DR72H474KW10#	
250Vdc	X7R	0.33μF	±10%	GRM55DR72E334KW01#	
			±10%	GRM55DR72E474KW01#	
		0.68μF	±10%	GRM55DR72E684KW01#	
			±10%	GRM55DR72E105KW01#	
200Vdc	X7R	0.33μF	±10%	GRM55DR72D334KW01#	
			±10%	GRM55DR72D474KW01#	
		0.68μF	±10%	GRM55DR72D684KW01#	
			±10%	GRM55DR72D105KW01#	

GRM
 GR3
 GRJ
 GR4
 GJM
 GQM
 GA2
 GA3 GB
 GA3 GD
 GA3 GF
 LLL
 LLA
 LLM
 LLR
 NFM
 GJ4
 ZRA
 ZRB
 KPM
 KR3
 GMA
 GMD
 ⚠Caution /Notice

High Effective Capacitance & High Ripple Current Chip Multilayer Ceramic Capacitors for General Purpose

GR3 Series



This is a general purpose high ripple resistance product excellent in DC bias characteristics.

Features

- ① When a DC bias is applied, a capacitance higher than conventional products (X7R characteristics) can be acquired.

About twice the capacitance can be secured when DC200V is applied.

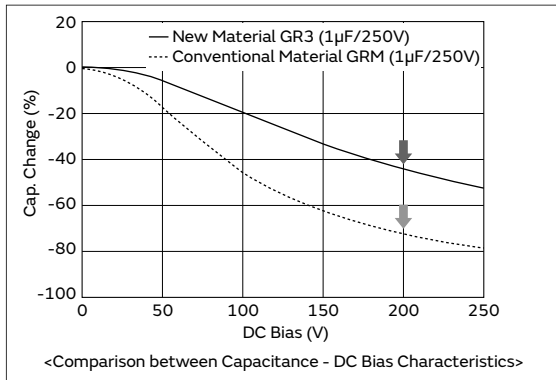

- ② Improved ripple resistance performance compared to conventional products (X7R characteristics).

In the case of a product with a capacitance of 1μF, when the exothermic temperature reaches 20°C at frequency f=300kHz, the amount of resistance of a product with conventional material is 2.9Arms; however, the new material is 4.7Arms.

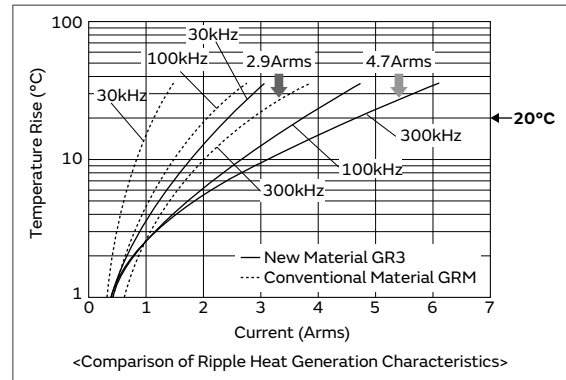

- ③ This product has a noise reduction effect.

Since dielectric materials which enable a reduction of noise are used, this product is more effective for reducing noise compared to the general purpose GRM series.

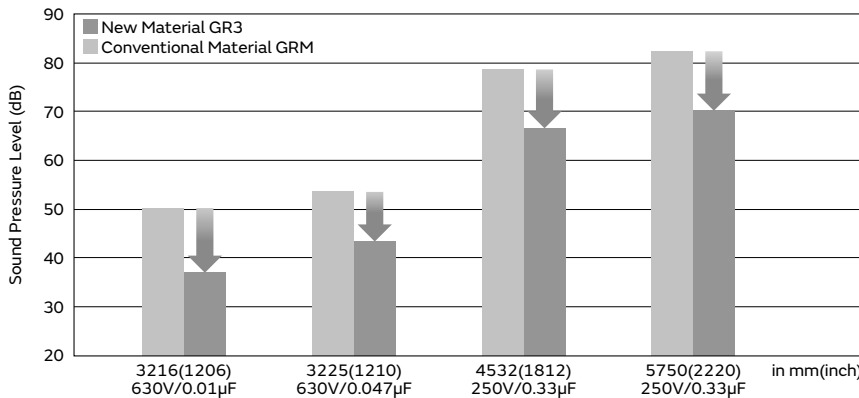

Specifications

Size (mm)	2.0×1.25mm to 5.7×5.0mm
Rated Voltage	250Vdc to 630Vdc
Capacitance	10000pF to 1.0μF
Main Applications	For PFC (Power Factor Correction) Circuits of Power Supplies, EMI Suppression and Smoothing Circuits

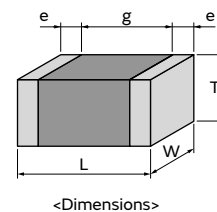

This catalog contains only a portion of the product lineup. Please refer to the capacitor search tool on the Murata Web site for details.

GR3 Series High Dielectric Constant Type Part Number List

2.0×1.25mm

Rated Voltage	TC Code	Cap.	Tol.	Part Number
250Vdc	X7T	10000pF	±10%	GR321AD72E103KW01#
		15000pF	±10%	GR321AD72E153KW01#
		22000pF	±10%	GR321BD72E223KW03#

Rated Voltage	TC Code	Cap.	Tol.	Part Number
250Vdc	X7T	1.0μF	±10%	GR355XD72E105KW05#

3.2×1.6mm

Rated Voltage	TC Code	Cap.	Tol.	Part Number
630Vdc	X7T	10000pF	±10%	GR331BD72J103KW01#
		15000pF	±10%	GR331CD72J153KW03#
450Vdc	X7T	10000pF	±10%	GR331AD72W103KW01#
		15000pF	±10%	GR331AD72W153KW01#
		22000pF	±10%	GR331BD72W223KW01#
		33000pF	±10%	GR331BD72W333KW01#
		47000pF	±10%	GR331CD72W473KW03#
250Vdc	X7T	33000pF	±10%	GR331AD72E333KW01#
		47000pF	±10%	GR331BD72E473KW01#
		68000pF	±10%	GR331CD72E683KW03#

3.2×2.5mm

Rated Voltage	TC Code	Cap.	Tol.	Part Number
630Vdc	X7T	22000pF	±10%	GR332QD72J223KW01#
		33000pF	±10%	GR332DD72J333KW01#
		47000pF	±10%	GR332DD72J473KW01#
450Vdc	X7T	68000pF	±10%	GR332DD72W683KW01#
		0.10μF	±10%	GR332DD72W104KW01#
250Vdc	X7T	0.10μF	±10%	GR332QD72E104KW01#
		0.15μF	±10%	GR332DD72E154KW01#

4.5×3.2mm

Rated Voltage	TC Code	Cap.	Tol.	Part Number
630Vdc	X7T	68000pF	±10%	GR343DD72J683KW01#
450Vdc	X7T	0.15μF	±10%	GR343DD72W154KW01#
250Vdc	X7T	0.22μF	±10%	GR343QD72E224KW01#
		0.33μF	±10%	GR343DD72E334KW01#

5.7×5.0mm

Rated Voltage	TC Code	Cap.	Tol.	Part Number
630Vdc	X7T	0.10μF	±10%	GR355DD72J104KW01#
		0.15μF	±10%	GR355DD72J154KW01#
		0.22μF	±10%	GR355XD72J224KW05#
450Vdc	X7T	0.22μF	±10%	GR355DD72W224KW01#
		0.33μF	±10%	GR355DD72W334KW01#
		0.47μF	±10%	GR355DD72W474KW01#
250Vdc	X7T	0.47μF	±10%	GR355DD72E474KW01#
		0.68μF	±10%	GR355DD72E684KW01#

Part number # indicates the package specification code.

- GRM
- GR3
- GRJ
- GR4
- GJM
- GQM
- GA2
- GA3 GB
- GA3 GD
- GA3 GF
- LLL
- LLA
- LLM
- LLR
- NFM
- GJ4
- ZRA
- ZRB
- KRM
- KR3
- GMA
- GMD
- ⚠Caution /Notice

Chip Multilayer Ceramic Capacitors with Soft Termination for General Purpose

GRJ Series



Cracking caused by flexing stress after board mounting is minimized due to resin external electrodes!

Features

① The resin external electrodes suppress cracks by board deflection.

Cracking of the ceramic element is suppressed by the resin of the external electrodes, which releases the stress.

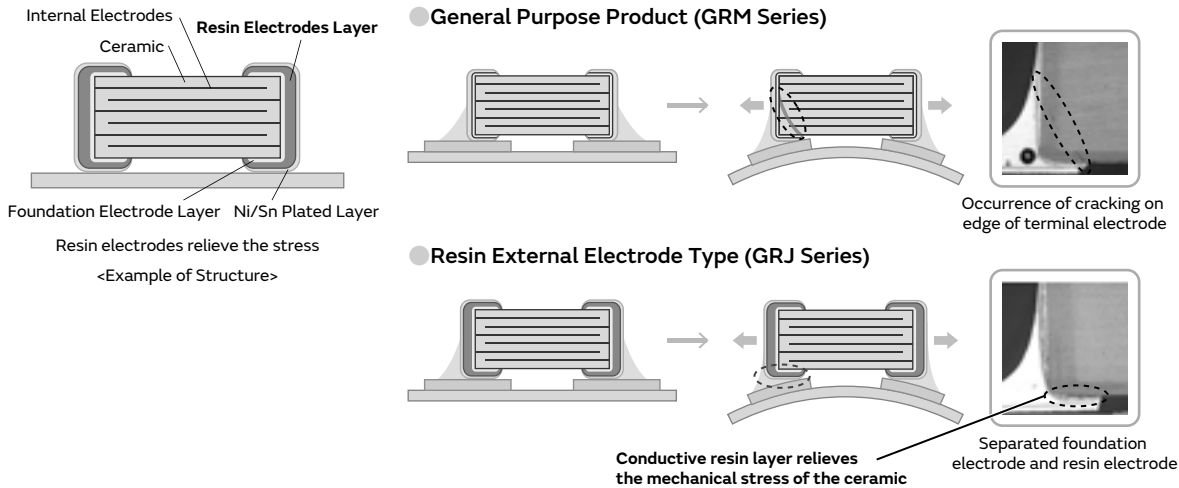

Note: Cracks may occur in the capacitor body if excessive stress beyond the "guaranteed range of board bending strength (*)" provided in the specifications is applied. Capacitors with cracks in them may cause a drop in insulation resistance, which could lead to a short circuit.
 (*) For details on the guaranteed range of board bending strength, check the "Detailed Specification Sheet" on the Product Details Page.

② Suppresses the occurrence of cracking caused by deflection stress at the time of board mounting, etc.

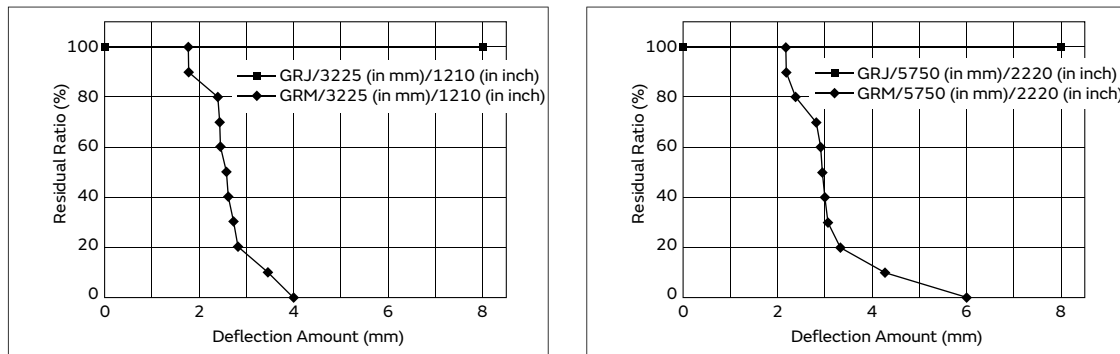

Due to the specification of the measuring instrument, measurements can be performed up to 8mm.

③ Ideal for consumer and industrial electronic equipment, etc. where there heat stress, vibration and impact are applied.

Specifications

Size (mm)	0.6×0.3mm to 5.7×5.0mm
Rated Voltage	6.3Vdc to 1000Vdc
Capacitance	33000pF to 47μF
Main Applications	Consumer & Industrial Electronic Equipment

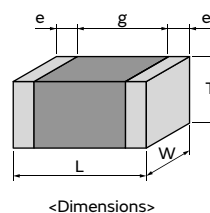

This catalog contains only a portion of the product lineup.
 Please refer to the capacitor search tool on the Murata Web site for details.

GRJ Series High Dielectric Constant Type Part Number List

0.6×0.3mm

Rated Voltage	TC Code	Cap.	Tol.	Part Number	
10Vdc	X5R	1.0μF	±20%	GRJ033R61A105ME11#	Mo D1
6.3Vdc	X5R	1.0μF	±20%	GRJ033R60J105ME11#	Mo D1

1.0×0.5mm

Rated Voltage	TC Code	Cap.	Tol.	Part Number	
6.3Vdc	X5R	10μF	±20%	GRJ155R60J106ME11#	Mo D1

1.6×0.8mm

Rated Voltage	TC Code	Cap.	Tol.	Part Number	
10Vdc	X5R	10μF	±20%	GRJ188R61A106ME11#	D1
6.3Vdc	X7S	4.7μF	±10%	GRJ188C70J475KE11#	
			±20%	GRJ188C70J475ME11#	
	X5R	10μF	±20%	GRJ188R60J106ME11#	

2.0×1.25mm

Rated Voltage	TC Code	Cap.	Tol.	Part Number	
100Vdc	X7S	1.0μF	±10%	GRJ21BC72A105KE11#	
			±20%	GRJ21BC72A105ME11#	
25Vdc	X5R	10μF	±10%	GRJ21BR61E106KE01#	D1

3.2×1.6mm

Rated Voltage	TC Code	Cap.	Tol.	Part Number	
100Vdc	X7S	4.7μF	±10%	GRJ31CC72A475KE01#	
			±20%	GRJ31CC72A475ME01#	
	X7R	4.7μF	±10%	GRJ31CZ72A475KE01#	
			±20%	GRJ31CZ72A475ME01#	
50Vdc	X7R	4.7μF	±10%	GRJ31CR71H475KE11#	
			±20%	GRJ31CR71H475ME11#	
	X7S	4.7μF	±10%	GRJ31CC71H475KE11#	
			±20%	GRJ31CC71H475ME11#	

3.2×2.5mm

Rated Voltage	TC Code	Cap.	Tol.	Part Number	
25Vdc	X7S	22μF	±10%	GRJ32EC71E226KE11#	
10Vdc	X7R	47μF	±10%	GRJ32ER71A476KE11#	
			±20%	GRJ32ER71A476ME11#	

4.5×3.2mm

Rated Voltage	TC Code	Cap.	Tol.	Part Number	
1000Vdc	X7R	33000pF	±10%	GRJ43DR73A333KWJ1#	

Rated Voltage	TC Code	Cap.	Tol.	Part Number		
1000Vdc	X7R	47000pF	±10%	GRJ43DR73A473KWJ1#		
630Vdc	X7R	68000pF	±10%	GRJ43QR72J683KWJ1#		
			0.10μF	±10%	GRJ43DR72J104KWJ1#	
250Vdc	X7R	0.15μF	±10%	GRJ43QR72E154KWJ1#		
			0.22μF	±10%	GRJ43DR72E224KWJ1#	
			0.33μF	±10%	GRJ43DR72E334KWJ1#	
			0.47μF	±10%	GRJ43DR72E474KWJ1#	

5.7×5.0mm

Rated Voltage	TC Code	Cap.	Tol.	Part Number		
1000Vdc	X7R	68000pF	±10%	GRJ55DR73A683KWJ1#		
			0.10μF	±10%	GRJ55DR73A104KWJ1#	
630Vdc	X7R	0.15μF	±10%	GRJ55DR72J154KWJ1#		
			0.22μF	±10%	GRJ55DR72J224KWJ1#	
250Vdc	X7R	0.33μF	±10%	GRJ55DR72E334KWJ1#		
			0.47μF	±10%	GRJ55DR72E474KWJ1#	
			0.68μF	±10%	GRJ55DR72E684KWJ1#	
			1.0μF	±10%	GRJ55DR72E105KWJ1#	

- GRM
- GR3
- GRJ
- GR4
- GJM
- GQM
- GA2
- GA3 GB
- GA3 GD
- GA3 GF
- LLL
- LLA
- LLM
- LLR
- NFM
- GJ4
- ZRA
- ZRB
- KRM
- KR3
- GMA
- GMD
- ⚠Caution /Notice

Chip Multilayer Ceramic Capacitors for Information Devices only

GR4 Series



Size (L*W) : 4.5x2.0mm - 5.7x5.0mm / X7R Char. / DC2kV
Realized large capacity and small size while maintaining high withstand voltages by the multilayer structure.

Features

- 1 For information devices of Ethernet LAN (IEEE802.3.) and primary - secondary couplings of DC-DC converters.

ex) DC-DC Converter

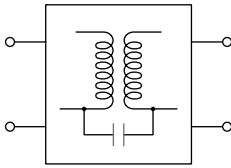

ex) LAN Connector

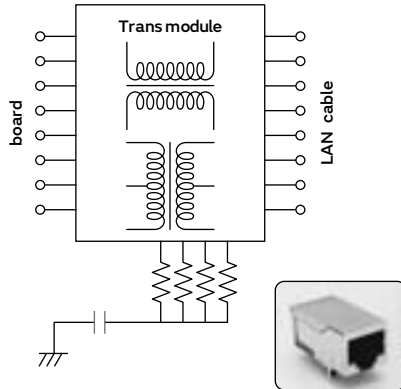

- 2 Realized large capacity and small size while maintaining high withstand voltages by the multilayer structure.

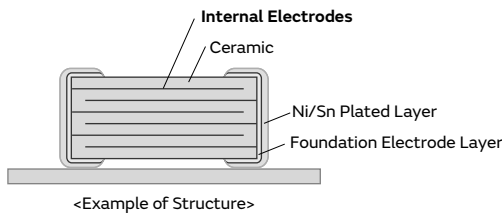

- 3 Dedicated for reflow soldering.

Specifications

Size (mm)	3.2×1.6mm to 5.7×5.0mm
Rated Voltage	630Vdc to 2000Vdc
Capacitance	100pF to 1500pF
Main Applications	For Ethernet LAN, Primary-secondary coupling for DC-DC converters

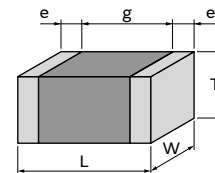

<Dimensions>

This catalog contains only a portion of the product lineup.
 Please refer to the capacitor search tool on the Murata Web site for details.

- GRM
- GR3
- GRJ
- GR4**
- GJM
- GQM
- GA2
- GA3 GB
- GA3 GD
- GA3 GF
- LLL
- LLA
- LLM
- LLR
- NFM
- GJ4
- ZRA
- ZRB
- KRM
- KR3
- GMA
- GMD
- ⚠Caution /Notice

GR4 Series Temperature Compensating Type Part Number List

3.2×1.6mm

Rated Voltage	TC Code	Cap.	Tol.	Part Number	
630Vdc	U2J	1000pF	±5%	GR431A7U2J102JWC2#	
		1200pF	±5%	GR431A7U2J122JWC2#	
		1500pF	±5%	GR431A7U2J152JWC2#	
		1800pF	±5%	GR431A7U2J182JWC2#	
		2200pF	±5%	GR431A7U2J222JWC2#	
		2700pF	±5%	GR431B7U2J272JWC2#	
		3300pF	±5%	GR431B7U2J332JWC2#	
		3900pF	±5%	GR431C7U2J392JWC1#	
		4700pF	±5%	GR431C7U2J472JWC1#	

3.2×2.5mm

Rated Voltage	TC Code	Cap.	Tol.	Part Number	
630Vdc	U2J	5600pF	±5%	GR432B7U2J562JWC2#	
		6800pF	±5%	GR432Q7U2J682JWC2#	
		8200pF	±5%	GR432D7U2J822JWC2#	
		10000pF	±5%	GR432D7U2J103JWC2#	
		12000pF	±5%	GR432E7U2J123JWC1#	
		15000pF	±5%	GR432E7U2J153JWC1#	

- GRM
- GR3
- GRJ
- GR4**
- GJM
- GQM
- GA2
- GA3 GB
- GA3 GD
- GA3 GF
- LLL
- LLA
- LLM
- LLR
- NFM
- GJ4
- ZRA
- ZRB
- KRM
- KR3
- GMA
- GMD
- ⚠Caution /Notice

Part number # indicates the package specification code.

GR4 Series High Dielectric Constant Type Part Number List

4.5×2.0mm

Rated Voltage	TC Code	Cap.	Tol.	Part Number	
2000Vdc	X7R	100pF	±10%	GR442QR73D101KW01#	
		120pF	±10%	GR442QR73D121KW01#	
		150pF	±10%	GR442QR73D151KW01#	
		180pF	±10%	GR442QR73D181KW01#	
		220pF	±10%	GR442QR73D221KW01#	
		270pF	±10%	GR442QR73D271KW01#	
		330pF	±10%	GR442QR73D331KW01#	
		390pF	±10%	GR442QR73D391KW01#	
		470pF	±10%	GR442QR73D471KW01#	
		560pF	±10%	GR442QR73D561KW01#	
		680pF	±10%	GR442QR73D681KW01#	
		820pF	±10%	GR442QR73D821KW01#	
		1000pF	±10%	GR442QR73D102KW01#	
		1200pF	±10%	GR442QR73D122KW01#	
1500pF	±10%	GR442QR73D152KW01#			

4.5×3.2mm

Rated Voltage	TC Code	Cap.	Tol.	Part Number	
2000Vdc	X7R	1800pF	±10%	GR443QR73D182KW01#	
		2200pF	±10%	GR443QR73D222KW01#	
		2700pF	±10%	GR443QR73D272KW01#	
		3300pF	±10%	GR443QR73D332KW01#	
		3900pF	±10%	GR443QR73D392KW01#	
		4700pF	±10%	GR443DR73D472KW01#	

5.7×5.0mm

Rated Voltage	TC Code	Cap.	Tol.	Part Number	
2000Vdc	X7R	10000pF	±10%	GR455DR73D103KW01#	

- GRM
- GR3
- GRJ
- GR4
- GJM
- GQM
- GA2
- GA3 GB
- GA3 GD
- GA3 GF
- LLL
- LLA
- LLM
- LLR
- NFM
- GJ4
- ZRA
- ZRB
- KRM
- KR3
- GMA
- GMD
- ⚠Caution /Notice

High Q Chip Multilayer Ceramic Capacitors for General Purpose ($\leq 100Vdc$)

GJM Series  **High Q** 

This product improves the high frequency characteristics and contributes to a reduction of power consumption by the High Q and low ESR.

Features

① **Mainly ideal for mobile communication devices and temperature compensation of related modules.**

This product is ideal for temperature compensation of high frequency circuits, such as resonant circuits, tuning circuits, and impedance matching circuits where the operating characteristics of the device are greatly affected by the capacitance fluctuation.

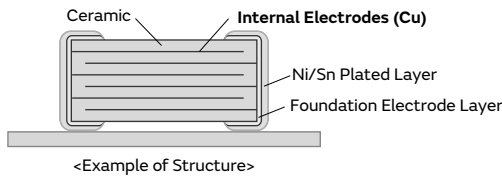

② **High Q and low ESR in VHF, UHF and microwave frequency bands.**

High Q and low ESR were achieved at a high frequency by adopting ceramic material as the dielectric material which enables an extremely low loss at high frequency, and base metal electrodes as the internal electrodes.

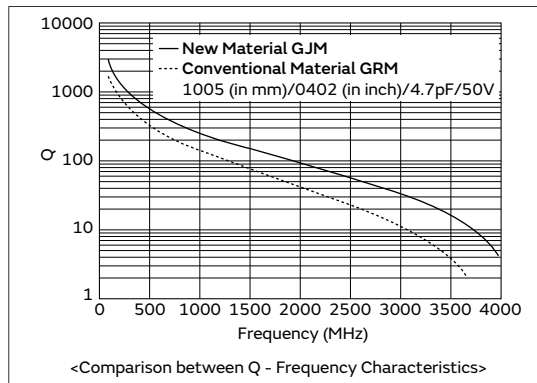
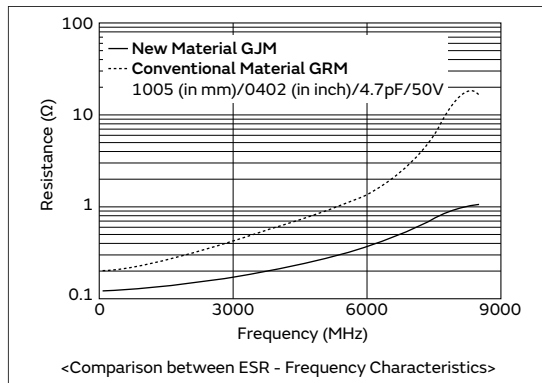

③ **Can be used for tight tolerance.**

In addition to standard tolerance, the allowable range of this product is also suitable for the following tight tolerance.

Capacitance Range	Standard Capacitance Tolerance (Capacitance Tolerance Symbol)	Narrow Capacitance Tolerance (Capacitance Tolerance Symbol)
to 0.9pF	$\pm 0.1pF$ (B)	$\pm 0.05pF$ (W)
1.0 to 5.0pF	$\pm 0.25pF$ (C)	$\pm 0.05pF$ (W), $\pm 0.1pF$ (B)
5.1 to 9.9pF	$\pm 0.5pF$ (D)	$\pm 0.05pF$ (W), $\pm 0.1pF$ (B), $\pm 0.25pF$ (C)
10pF~	$\pm 5\%$ (J)	$\pm 2\%$ (G)

Specifications

Size (mm)	0.4×0.2mm to 1.0×0.5mm
Rated Voltage	6.3Vdc to 100Vdc
Capacitance	0.10pF to 47pF
Main Applications	Small communication devices, such as mobile phones and high frequency communication modules

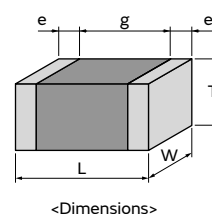

This catalog contains only a portion of the product lineup. Please refer to the capacitor search tool on the Murata Web site for details.

GJM Series Temperature Compensating Type **High Q** Part Number List

0.4×0.2mm

Rated Voltage	TC Code	Cap.	Tol.	Part Number
25Vdc	COG	0.20pF	±0.05pF	GJM0225C1ER20WB01#
			±0.1pF	GJM0225C1ER20BB01#
		0.30pF	±0.05pF	GJM0225C1ER30WB01#
			±0.1pF	GJM0225C1ER30BB01#
		0.40pF	±0.05pF	GJM0225C1ER40WB01#
			±0.1pF	GJM0225C1ER40BB01#
		0.50pF	±0.05pF	GJM0225C1ER50WB01#
			±0.1pF	GJM0225C1ER50BB01#
		0.60pF	±0.05pF	GJM0225C1ER60WB01#
			±0.1pF	GJM0225C1ER60BB01#
		0.70pF	±0.05pF	GJM0225C1ER70WB01#
			±0.1pF	GJM0225C1ER70BB01#
		0.80pF	±0.05pF	GJM0225C1ER80WB01#
			±0.1pF	GJM0225C1ER80BB01#
		0.90pF	±0.05pF	GJM0225C1ER90WB01#
			±0.1pF	GJM0225C1ER90BB01#
		1.0pF	±0.05pF	GJM0225C1E1R0WB01#
			±0.1pF	GJM0225C1E1R0BB01#
			±0.25pF	GJM0225C1E1R0CB01#
		1.1pF	±0.05pF	GJM0225C1E1R1WB01#
			±0.1pF	GJM0225C1E1R1BB01#
			±0.25pF	GJM0225C1E1R1CB01#
		1.2pF	±0.05pF	GJM0225C1E1R2WB01#
			±0.1pF	GJM0225C1E1R2BB01#
			±0.25pF	GJM0225C1E1R2CB01#
		1.3pF	±0.05pF	GJM0225C1E1R3WB01#
			±0.1pF	GJM0225C1E1R3BB01#
			±0.25pF	GJM0225C1E1R3CB01#
		1.4pF	±0.05pF	GJM0225C1E1R4WB01#
			±0.1pF	GJM0225C1E1R4BB01#
			±0.25pF	GJM0225C1E1R4CB01#
		1.5pF	±0.05pF	GJM0225C1E1R5WB01#
			±0.1pF	GJM0225C1E1R5BB01#
			±0.25pF	GJM0225C1E1R5CB01#
		1.6pF	±0.05pF	GJM0225C1E1R6WB01#
			±0.1pF	GJM0225C1E1R6BB01#
			±0.25pF	GJM0225C1E1R6CB01#
		1.7pF	±0.05pF	GJM0225C1E1R7WB01#
			±0.1pF	GJM0225C1E1R7BB01#
			±0.25pF	GJM0225C1E1R7CB01#
		1.8pF	±0.05pF	GJM0225C1E1R8WB01#
			±0.1pF	GJM0225C1E1R8BB01#
			±0.25pF	GJM0225C1E1R8CB01#
		1.9pF	±0.05pF	GJM0225C1E1R9WB01#
			±0.1pF	GJM0225C1E1R9BB01#
			±0.25pF	GJM0225C1E1R9CB01#
		2.0pF	±0.05pF	GJM0225C1E2R0WB01#
			±0.1pF	GJM0225C1E2R0BB01#
±0.25pF	GJM0225C1E2R0CB01#			
2.1pF	±0.05pF	GJM0225C1E2R1WB01#		
	±0.1pF	GJM0225C1E2R1BB01#		
	±0.25pF	GJM0225C1E2R1CB01#		

Rated Voltage	TC Code	Cap.	Tol.	Part Number
25Vdc	COG	2.2pF	±0.05pF	GJM0225C1E2R2WB01#
			±0.1pF	GJM0225C1E2R2BB01#
			±0.25pF	GJM0225C1E2R2CB01#
		2.3pF	±0.05pF	GJM0225C1E2R3WB01#
			±0.1pF	GJM0225C1E2R3BB01#
			±0.25pF	GJM0225C1E2R3CB01#
		2.4pF	±0.05pF	GJM0225C1E2R4WB01#
			±0.1pF	GJM0225C1E2R4BB01#
			±0.25pF	GJM0225C1E2R4CB01#
		2.5pF	±0.05pF	GJM0225C1E2R5WB01#
			±0.1pF	GJM0225C1E2R5BB01#
			±0.25pF	GJM0225C1E2R5CB01#
		2.6pF	±0.05pF	GJM0225C1E2R6WB01#
			±0.1pF	GJM0225C1E2R6BB01#
			±0.25pF	GJM0225C1E2R6CB01#
		2.7pF	±0.05pF	GJM0225C1E2R7WB01#
			±0.1pF	GJM0225C1E2R7BB01#
			±0.25pF	GJM0225C1E2R7CB01#
		2.8pF	±0.05pF	GJM0225C1E2R8WB01#
			±0.1pF	GJM0225C1E2R8BB01#
			±0.25pF	GJM0225C1E2R8CB01#
		2.9pF	±0.05pF	GJM0225C1E2R9WB01#
			±0.1pF	GJM0225C1E2R9BB01#
			±0.25pF	GJM0225C1E2R9CB01#
		3.0pF	±0.05pF	GJM0225C1E3R0WB01#
			±0.1pF	GJM0225C1E3R0BB01#
			±0.25pF	GJM0225C1E3R0CB01#
		3.1pF	±0.05pF	GJM0225C1E3R1WB01#
			±0.1pF	GJM0225C1E3R1BB01#
			±0.25pF	GJM0225C1E3R1CB01#
		3.2pF	±0.05pF	GJM0225C1E3R2WB01#
			±0.1pF	GJM0225C1E3R2BB01#
			±0.25pF	GJM0225C1E3R2CB01#
		3.3pF	±0.05pF	GJM0225C1E3R3WB01#
			±0.1pF	GJM0225C1E3R3BB01#
			±0.25pF	GJM0225C1E3R3CB01#
		3.4pF	±0.05pF	GJM0225C1E3R4WB01#
			±0.1pF	GJM0225C1E3R4BB01#
			±0.25pF	GJM0225C1E3R4CB01#
		3.5pF	±0.05pF	GJM0225C1E3R5WB01#
			±0.1pF	GJM0225C1E3R5BB01#
			±0.25pF	GJM0225C1E3R5CB01#
		3.6pF	±0.05pF	GJM0225C1E3R6WB01#
			±0.1pF	GJM0225C1E3R6BB01#
			±0.25pF	GJM0225C1E3R6CB01#
		3.7pF	±0.05pF	GJM0225C1E3R7WB01#
			±0.1pF	GJM0225C1E3R7BB01#
			±0.25pF	GJM0225C1E3R7CB01#
3.8pF	±0.05pF	GJM0225C1E3R8WB01#		
	±0.1pF	GJM0225C1E3R8BB01#		
	±0.25pF	GJM0225C1E3R8CB01#		
3.9pF	±0.05pF	GJM0225C1E3R9WB01#		
	±0.1pF	GJM0225C1E3R9BB01#		
	±0.25pF	GJM0225C1E3R9CB01#		

- GRM
- GR3
- GRJ
- GR4
- GJM
- GQM
- GA2
- GA3 GB
- GA3 GD
- GA3 GF
- LLL
- LLA
- LLM
- LLR
- NFM
- GJ4
- ZRA
- ZRB
- KRM
- KR3
- GMA
- GMD
- ⚠Caution /Notice

Part number # indicates the package specification code.

GJM Series Temperature Compensating Type High Q Part Number List

(→ 0.4×0.2mm)

Rated Voltage	TC Code	Cap.	Tol.	Part Number	Rated Voltage	TC Code	Cap.	Tol.	Part Number	
25Vdc	COG	4.0pF	±0.05pF	GJM0225C1E4R0WB01#	25Vdc	COG	5.6pF	±0.1pF	GJM0225C1E5R6BB01#	
			±0.1pF	GJM0225C1E4R0BB01#				±0.25pF	GJM0225C1E5R6CB01#	
			±0.25pF	GJM0225C1E4R0CB01#				±0.5pF	GJM0225C1E5R6DB01#	
		4.1pF	±0.05pF	GJM0225C1E4R1WB01#			5.7pF	±0.05pF	GJM0225C1E5R7WB01#	
			±0.1pF	GJM0225C1E4R1BB01#				±0.1pF	GJM0225C1E5R7BB01#	
			±0.25pF	GJM0225C1E4R1CB01#				±0.25pF	GJM0225C1E5R7CB01#	
		4.2pF	±0.05pF	GJM0225C1E4R2WB01#			5.8pF	±0.5pF	GJM0225C1E5R7DB01#	
			±0.1pF	GJM0225C1E4R2BB01#				6.0pF	±0.05pF	GJM0225C1E5R8WB01#
			±0.25pF	GJM0225C1E4R2CB01#					±0.1pF	GJM0225C1E5R8BB01#
		4.3pF	±0.05pF	GJM0225C1E4R3WB01#			5.9pF		±0.25pF	GJM0225C1E5R8CB01#
			±0.1pF	GJM0225C1E4R3BB01#				±0.5pF	GJM0225C1E5R8DB01#	
			±0.25pF	GJM0225C1E4R3CB01#				6.1pF	±0.05pF	GJM0225C1E5R9WB01#
		4.4pF	±0.05pF	GJM0225C1E4R4WB01#			6.0pF		±0.1pF	GJM0225C1E5R9BB01#
			±0.1pF	GJM0225C1E4R4BB01#					±0.25pF	GJM0225C1E5R9CB01#
			±0.25pF	GJM0225C1E4R4CB01#				±0.5pF	GJM0225C1E5R9DB01#	
		4.5pF	±0.05pF	GJM0225C1E4R5WB01#			6.0pF	±0.05pF	GJM0225C1E6R0WB01#	
			±0.1pF	GJM0225C1E4R5BB01#				±0.1pF	GJM0225C1E6R0BB01#	
			±0.25pF	GJM0225C1E4R5CB01#				±0.25pF	GJM0225C1E6R0CB01#	
		4.6pF	±0.05pF	GJM0225C1E4R6WB01#			6.1pF	±0.5pF	GJM0225C1E6R0DB01#	
			±0.1pF	GJM0225C1E4R6BB01#				6.2pF	±0.05pF	GJM0225C1E6R1WB01#
			±0.25pF	GJM0225C1E4R6CB01#					±0.1pF	GJM0225C1E6R1BB01#
		4.7pF	±0.05pF	GJM0225C1E4R7WB01#			6.3pF		±0.25pF	GJM0225C1E6R1CB01#
			±0.1pF	GJM0225C1E4R7BB01#				±0.5pF	GJM0225C1E6R1DB01#	
			±0.25pF	GJM0225C1E4R7CB01#				6.4pF	±0.05pF	GJM0225C1E6R2WB01#
		4.8pF	±0.05pF	GJM0225C1E4R8WB01#			6.2pF		±0.1pF	GJM0225C1E6R2BB01#
			±0.1pF	GJM0225C1E4R8BB01#					±0.25pF	GJM0225C1E6R2CB01#
			±0.25pF	GJM0225C1E4R8CB01#				±0.5pF	GJM0225C1E6R2DB01#	
		4.9pF	±0.05pF	GJM0225C1E4R9WB01#			6.3pF	±0.05pF	GJM0225C1E6R3WB01#	
			±0.1pF	GJM0225C1E4R9BB01#				±0.1pF	GJM0225C1E6R3BB01#	
			±0.25pF	GJM0225C1E4R9CB01#				±0.25pF	GJM0225C1E6R3CB01#	
		5.0pF	±0.05pF	GJM0225C1E5R0WB01#			6.4pF	±0.5pF	GJM0225C1E6R3DB01#	
			±0.1pF	GJM0225C1E5R0BB01#				6.5pF	±0.05pF	GJM0225C1E6R4WB01#
			±0.25pF	GJM0225C1E5R0CB01#					±0.1pF	GJM0225C1E6R4BB01#
		5.1pF	±0.05pF	GJM0225C1E5R1WB01#			6.5pF		±0.25pF	GJM0225C1E6R4CB01#
			±0.1pF	GJM0225C1E5R1BB01#				±0.5pF	GJM0225C1E6R4DB01#	
			±0.25pF	GJM0225C1E5R1CB01#				6.6pF	±0.05pF	GJM0225C1E6R5WB01#
		5.2pF	±0.5pF	GJM0225C1E5R1DB01#			6.4pF		±0.1pF	GJM0225C1E6R5BB01#
			±0.05pF	GJM0225C1E5R2WB01#					±0.25pF	GJM0225C1E6R5CB01#
			±0.1pF	GJM0225C1E5R2BB01#				±0.5pF	GJM0225C1E6R5DB01#	
		5.3pF	±0.25pF	GJM0225C1E5R2CB01#			6.6pF	±0.05pF	GJM0225C1E6R6WB01#	
			±0.5pF	GJM0225C1E5R2DB01#				±0.1pF	GJM0225C1E6R6BB01#	
			±0.05pF	GJM0225C1E5R3WB01#				±0.25pF	GJM0225C1E6R6CB01#	
		5.4pF	±0.1pF	GJM0225C1E5R3BB01#			6.7pF	±0.5pF	GJM0225C1E6R6DB01#	
			±0.25pF	GJM0225C1E5R3CB01#				6.8pF	±0.05pF	GJM0225C1E6R7WB01#
			±0.5pF	GJM0225C1E5R3DB01#					±0.1pF	GJM0225C1E6R7BB01#
		5.5pF	±0.05pF	GJM0225C1E5R4WB01#			6.8pF		±0.25pF	GJM0225C1E6R7CB01#
			±0.1pF	GJM0225C1E5R4BB01#				±0.5pF	GJM0225C1E6R7DB01#	
			±0.25pF	GJM0225C1E5R4CB01#				6.9pF	±0.05pF	GJM0225C1E6R8WB01#
		5.6pF	±0.5pF	GJM0225C1E5R4DB01#			6.8pF		±0.1pF	GJM0225C1E6R8BB01#
			±0.05pF	GJM0225C1E5R5WB01#					±0.25pF	GJM0225C1E6R8CB01#
			±0.1pF	GJM0225C1E5R5BB01#				±0.5pF	GJM0225C1E6R8DB01#	
		5.6pF	±0.25pF	GJM0225C1E5R5CB01#			6.9pF	±0.05pF	GJM0225C1E6R9WB01#	
			±0.5pF	GJM0225C1E5R5DB01#				±0.1pF	GJM0225C1E6R9BB01#	
			±0.05pF	GJM0225C1E5R6WB01#				±0.25pF	GJM0225C1E6R9CB01#	

Part number # indicates the package specification code.

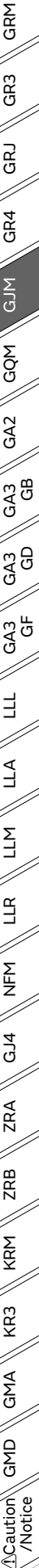

GJM Series Temperature Compensating Type High Q Part Number List

(→ 0.4×0.2mm)

Rated Voltage	TC Code	Cap.	Tol.	Part Number	Rated Voltage	TC Code	Cap.	Tol.	Part Number
25Vdc	COG	6.9pF	±0.5pF	GJM0225C1E6R9DB01#	25Vdc	COG	8.3pF	±0.1pF	GJM0225C1E8R3BB01#
			±0.05pF	GJM0225C1E7R0WB01#				±0.25pF	GJM0225C1E8R3CB01#
			±0.1pF	GJM0225C1E7R0BB01#				±0.5pF	GJM0225C1E8R3DB01#
			±0.25pF	GJM0225C1E7R0CB01#				8.4pF	±0.05pF
		±0.5pF	GJM0225C1E7R0DB01#	±0.1pF			GJM0225C1E8R4BB01#		
		7.1pF	±0.05pF	GJM0225C1E7R1WB01#			±0.25pF		GJM0225C1E8R4CB01#
			±0.1pF	GJM0225C1E7R1BB01#			±0.5pF		GJM0225C1E8R4DB01#
			±0.25pF	GJM0225C1E7R1CB01#			8.5pF	±0.05pF	GJM0225C1E8R5WB01#
			±0.5pF	GJM0225C1E7R1DB01#				±0.1pF	GJM0225C1E8R5BB01#
		7.2pF	±0.05pF	GJM0225C1E7R2WB01#				±0.25pF	GJM0225C1E8R5CB01#
			±0.1pF	GJM0225C1E7R2BB01#				±0.5pF	GJM0225C1E8R5DB01#
			±0.25pF	GJM0225C1E7R2CB01#			8.6pF	±0.05pF	GJM0225C1E8R6WB01#
			±0.5pF	GJM0225C1E7R2DB01#				±0.1pF	GJM0225C1E8R6BB01#
		7.3pF	±0.05pF	GJM0225C1E7R3WB01#				±0.25pF	GJM0225C1E8R6CB01#
			±0.1pF	GJM0225C1E7R3BB01#				±0.5pF	GJM0225C1E8R6DB01#
			±0.25pF	GJM0225C1E7R3CB01#			8.7pF	±0.05pF	GJM0225C1E8R7WB01#
			±0.5pF	GJM0225C1E7R3DB01#				±0.1pF	GJM0225C1E8R7BB01#
		7.4pF	±0.05pF	GJM0225C1E7R4WB01#				±0.25pF	GJM0225C1E8R7CB01#
			±0.1pF	GJM0225C1E7R4BB01#				±0.5pF	GJM0225C1E8R7DB01#
			±0.25pF	GJM0225C1E7R4CB01#			8.8pF	±0.05pF	GJM0225C1E8R8WB01#
			±0.5pF	GJM0225C1E7R4DB01#				±0.1pF	GJM0225C1E8R8BB01#
		7.5pF	±0.05pF	GJM0225C1E7R5WB01#				±0.25pF	GJM0225C1E8R8CB01#
			±0.1pF	GJM0225C1E7R5BB01#				±0.5pF	GJM0225C1E8R8DB01#
			±0.25pF	GJM0225C1E7R5CB01#			8.9pF	±0.05pF	GJM0225C1E8R9WB01#
			±0.5pF	GJM0225C1E7R5DB01#				±0.1pF	GJM0225C1E8R9BB01#
		7.6pF	±0.05pF	GJM0225C1E7R6WB01#				±0.25pF	GJM0225C1E8R9CB01#
			±0.1pF	GJM0225C1E7R6BB01#				±0.5pF	GJM0225C1E8R9DB01#
			±0.25pF	GJM0225C1E7R6CB01#			9.0pF	±0.05pF	GJM0225C1E9R0WB01#
			±0.5pF	GJM0225C1E7R6DB01#				±0.1pF	GJM0225C1E9R0BB01#
		7.7pF	±0.05pF	GJM0225C1E7R7WB01#				±0.25pF	GJM0225C1E9R0CB01#
			±0.1pF	GJM0225C1E7R7BB01#				±0.5pF	GJM0225C1E9R0DB01#
			±0.25pF	GJM0225C1E7R7CB01#			9.1pF	±0.05pF	GJM0225C1E9R1WB01#
			±0.5pF	GJM0225C1E7R7DB01#				±0.1pF	GJM0225C1E9R1BB01#
		7.8pF	±0.05pF	GJM0225C1E7R8WB01#				±0.25pF	GJM0225C1E9R1CB01#
			±0.1pF	GJM0225C1E7R8BB01#				±0.5pF	GJM0225C1E9R1DB01#
			±0.25pF	GJM0225C1E7R8CB01#			9.2pF	±0.05pF	GJM0225C1E9R2WB01#
			±0.5pF	GJM0225C1E7R8DB01#				±0.1pF	GJM0225C1E9R2BB01#
		7.9pF	±0.05pF	GJM0225C1E7R9WB01#				±0.25pF	GJM0225C1E9R2CB01#
			±0.1pF	GJM0225C1E7R9BB01#				±0.5pF	GJM0225C1E9R2DB01#
			±0.25pF	GJM0225C1E7R9CB01#			9.3pF	±0.05pF	GJM0225C1E9R3WB01#
			±0.5pF	GJM0225C1E7R9DB01#				±0.1pF	GJM0225C1E9R3BB01#
		8.0pF	±0.05pF	GJM0225C1E8R0WB01#				±0.25pF	GJM0225C1E9R3CB01#
			±0.1pF	GJM0225C1E8R0BB01#				±0.5pF	GJM0225C1E9R3DB01#
			±0.25pF	GJM0225C1E8R0CB01#			9.4pF	±0.05pF	GJM0225C1E9R4WB01#
			±0.5pF	GJM0225C1E8R0DB01#				±0.1pF	GJM0225C1E9R4BB01#
		8.1pF	±0.05pF	GJM0225C1E8R1WB01#				±0.25pF	GJM0225C1E9R4CB01#
			±0.1pF	GJM0225C1E8R1BB01#				±0.5pF	GJM0225C1E9R4DB01#
			±0.25pF	GJM0225C1E8R1CB01#			9.5pF	±0.05pF	GJM0225C1E9R5WB01#
			±0.5pF	GJM0225C1E8R1DB01#				±0.1pF	GJM0225C1E9R5BB01#
		8.2pF	±0.05pF	GJM0225C1E8R2WB01#				±0.25pF	GJM0225C1E9R5CB01#
			±0.1pF	GJM0225C1E8R2BB01#				±0.5pF	GJM0225C1E9R5DB01#
			±0.25pF	GJM0225C1E8R2CB01#			9.6pF	±0.05pF	GJM0225C1E9R6WB01#
			±0.5pF	GJM0225C1E8R2DB01#				±0.1pF	GJM0225C1E9R6BB01#
		8.3pF	±0.05pF	GJM0225C1E8R3WB01#				±0.25pF	GJM0225C1E9R6CB01#

- GRM
- GR3
- GRJ
- GR4
- GJM
- GQM
- GQ2
- GA2
- GA3
- GA3
- GA3
- GA3
- GA3
- LL
- LLA
- LLM
- LLR
- NFM
- GJ4
- ZRA
- ZRB
- KRM
- KR3
- GMA
- GMD
- ⚠Caution / Notice

Part number # indicates the package specification code.

GJM Series Temperature Compensating Type **High Q** Part Number List

(→ 0.4×0.2mm)

Rated Voltage	TC Code	Cap.	Tol.	Part Number	Rated Voltage	TC Code	Cap.	Tol.	Part Number			
25Vdc	COG	9.6pF	±0.5pF	GJM0225C1E9R6DB01#	25Vdc	CH	4.7pF	±0.1pF	GJM0222C1E4R7BB01#			
			±0.05pF	GJM0225C1E9R7WB01#				±0.25pF	GJM0222C1E4R7CB01#			
		±0.1pF	GJM0225C1E9R7BB01#	4.8pF			±0.05pF	GJM0222C1E4R8WB01#				
		±0.25pF	GJM0225C1E9R7CB01#				±0.1pF	GJM0222C1E4R8BB01#				
		9.8pF	±0.05pF	GJM0225C1E9R8WB01#			±0.25pF	GJM0222C1E4R8CB01#	4.9pF	±0.05pF	GJM0222C1E4R9WB01#	
			±0.1pF	GJM0225C1E9R8BB01#			±0.1pF	GJM0222C1E4R9BB01#		±0.1pF	GJM0222C1E4R9WB01#	
			±0.25pF	GJM0225C1E9R8CB01#			±0.25pF	GJM0222C1E4R9CB01#		5.0pF	±0.05pF	GJM0222C1E5R0WB01#
			±0.5pF	GJM0225C1E9R8DB01#			±0.1pF	GJM0222C1E5R0BB01#	±0.1pF		GJM0222C1E5R0CB01#	
		9.9pF	±0.05pF	GJM0225C1E9R9WB01#			10pF	±1%	GJM0225C1E100FB01#	5.1pF	±0.05pF	GJM0222C1E5R1WB01#
			±0.1pF	GJM0225C1E9R9BB01#				±2%	GJM0225C1E100GB01#		±0.1pF	GJM0222C1E5R1BB01#
			±0.25pF	GJM0225C1E9R9CB01#				±5%	GJM0225C1E100JB01#		±0.25pF	GJM0222C1E5R1CB01#
			±0.5pF	GJM0225C1E9R9DB01#				11pF	±2%		GJM0225C1E110GB01#	±0.5pF
		12pF	±2%	GJM0225C1E120GB01#			±5%		GJM0225C1E110JB01#	5.2pF	±0.05pF	GJM0222C1E5R2WB01#
			±5%	GJM0225C1E120JB01#			13pF	±2%	GJM0225C1E130GB01#		±0.1pF	GJM0222C1E5R2BB01#
		15pF	±2%	GJM0225C1E150GB01#				±5%	GJM0225C1E130JB01#	±0.25pF	GJM0222C1E5R2CB01#	
			±5%	GJM0225C1E150JB01#			16pF	±2%	GJM0225C1E160GB01#	±0.5pF	GJM0222C1E5R2DB01#	
		±5%	GJM0225C1E160JB01#	18pF				±2%	GJM0225C1E180GB01#	5.3pF	±0.05pF	GJM0222C1E5R3WB01#
		20pF	±2%				GJM0225C1E200GB01#	±5%	GJM0225C1E180JB01#		±0.1pF	GJM0222C1E5R3BB01#
			±5%	GJM0225C1E200JB01#			22pF	±2%	GJM0225C1E220GB01#	±0.25pF	GJM0222C1E5R3CB01#	
		±5%	GJM0225C1E220JB01#	4.0pF				±0.05pF	GJM0222C1E4R0WB01#	±0.5pF	GJM0222C1E5R3DB01#	
		4.1pF	±0.1pF				GJM0222C1E4R0BB01#	4.1pF	±0.05pF	GJM0222C1E4R1WB01#	5.4pF	±0.05pF
			±0.25pF	GJM0222C1E4R0CB01#			±0.1pF		GJM0222C1E4R1BB01#	±0.1pF		GJM0222C1E5R4BB01#
			±0.25pF	GJM0222C1E4R1CB01#			±0.25pF		GJM0222C1E4R1CB01#	±0.25pF		GJM0222C1E5R4CB01#
		4.2pF	±0.05pF	GJM0222C1E4R2WB01#			4.2pF	±0.05pF	GJM0222C1E4R2WB01#	5.5pF	±0.05pF	GJM0222C1E5R5WB01#
			±0.1pF	GJM0222C1E4R2BB01#				±0.1pF	GJM0222C1E4R2BB01#		±0.1pF	GJM0222C1E5R5BB01#
			±0.25pF	GJM0222C1E4R2CB01#				±0.25pF	GJM0222C1E4R2CB01#		±0.25pF	GJM0222C1E5R5CB01#
		4.3pF	±0.05pF	GJM0222C1E4R3WB01#			4.3pF	±0.05pF	GJM0222C1E4R3WB01#	5.6pF	±0.05pF	GJM0222C1E5R6WB01#
			±0.1pF	GJM0222C1E4R3BB01#				±0.1pF	GJM0222C1E4R3BB01#		±0.1pF	GJM0222C1E5R6BB01#
			±0.25pF	GJM0222C1E4R3CB01#				±0.25pF	GJM0222C1E4R3CB01#		±0.25pF	GJM0222C1E5R6CB01#
		4.4pF	±0.05pF	GJM0222C1E4R4WB01#			4.4pF	±0.05pF	GJM0222C1E4R4WB01#	5.7pF	±0.05pF	GJM0222C1E5R7WB01#
			±0.1pF	GJM0222C1E4R4BB01#				±0.1pF	GJM0222C1E4R4BB01#		±0.1pF	GJM0222C1E5R7BB01#
			±0.25pF	GJM0222C1E4R4CB01#				±0.25pF	GJM0222C1E4R4CB01#		±0.25pF	GJM0222C1E5R7CB01#
		4.5pF	±0.05pF	GJM0222C1E4R5WB01#			4.5pF	±0.05pF	GJM0222C1E4R5WB01#	5.8pF	±0.05pF	GJM0222C1E5R8WB01#
			±0.1pF	GJM0222C1E4R5BB01#				±0.1pF	GJM0222C1E4R5BB01#		±0.1pF	GJM0222C1E5R8BB01#
			±0.25pF	GJM0222C1E4R5CB01#				±0.25pF	GJM0222C1E4R5CB01#		±0.25pF	GJM0222C1E5R8CB01#
		4.6pF	±0.05pF	GJM0222C1E4R6WB01#			4.6pF	±0.05pF	GJM0222C1E4R6WB01#	5.9pF	±0.05pF	GJM0222C1E5R9WB01#
			±0.1pF	GJM0222C1E4R6BB01#				±0.1pF	GJM0222C1E4R6BB01#		±0.1pF	GJM0222C1E5R9BB01#
			±0.25pF	GJM0222C1E4R6CB01#				±0.25pF	GJM0222C1E4R6CB01#		±0.25pF	GJM0222C1E5R9CB01#
		4.7pF	±0.05pF	GJM0222C1E4R7WB01#			4.7pF	±0.05pF	GJM0222C1E4R7WB01#	6.0pF	±0.05pF	GJM0222C1E6R0WB01#
			±0.1pF	GJM0222C1E4R7BB01#				±0.1pF	GJM0222C1E4R7BB01#		±0.1pF	GJM0222C1E6R0BB01#
			±0.25pF	GJM0222C1E4R7CB01#				±0.25pF	GJM0222C1E4R7CB01#		±0.25pF	GJM0222C1E6R0CB01#
		6.1pF	±0.05pF	GJM0222C1E6R1WB01#			6.1pF	±0.05pF	GJM0222C1E6R1WB01#	6.1pF	±0.05pF	GJM0222C1E6R1WB01#
±0.1pF	GJM0222C1E6R1BB01#		±0.1pF	GJM0222C1E6R1BB01#	±0.1pF	GJM0222C1E6R1BB01#						
±0.25pF	GJM0222C1E6R1CB01#		±0.25pF	GJM0222C1E6R1CB01#	±0.25pF	GJM0222C1E6R1CB01#						

Part number # indicates the package specification code.

- GRM
- GR3
- GRJ
- GR4
- GJM
- GQM
- GGA2
- GA3 GB
- GA3 GD
- GA3 GF
- LLL
- LLA
- LLM
- LLR
- NFM
- GJ4
- ZRA
- ZRB
- KRM
- KR3
- GMA
- GMD
- ⚠Caution /Notice

GJM Series Temperature Compensating Type High Q Part Number List

(→ 0.4×0.2mm)

Rated Voltage	TC Code	Cap.	Tol.	Part Number	Rated Voltage	TC Code	Cap.	Tol.	Part Number
25Vdc	CH	6.1pF	±0.5pF	GJM0222C1E6R1DB01#	25Vdc	CH	7.5pF	±0.1pF	GJM0222C1E7R5BB01#
			±0.05pF	GJM0222C1E6R2WB01#				±0.25pF	GJM0222C1E7R5CB01#
			±0.1pF	GJM0222C1E6R2BB01#				±0.5pF	GJM0222C1E7R5DB01#
			±0.25pF	GJM0222C1E6R2CB01#				7.6pF	±0.05pF
		±0.5pF	GJM0222C1E6R2DB01#	±0.1pF			GJM0222C1E7R6BB01#		
		6.3pF	±0.05pF	GJM0222C1E6R3WB01#			±0.25pF		GJM0222C1E7R6CB01#
			±0.1pF	GJM0222C1E6R3BB01#			±0.5pF		GJM0222C1E7R6DB01#
			±0.25pF	GJM0222C1E6R3CB01#			7.7pF	±0.05pF	GJM0222C1E7R7WB01#
			±0.5pF	GJM0222C1E6R3DB01#				±0.1pF	GJM0222C1E7R7BB01#
		6.4pF	±0.05pF	GJM0222C1E6R4WB01#				±0.25pF	GJM0222C1E7R7CB01#
			±0.1pF	GJM0222C1E6R4BB01#				±0.5pF	GJM0222C1E7R7DB01#
			±0.25pF	GJM0222C1E6R4CB01#			7.8pF	±0.05pF	GJM0222C1E7R8WB01#
			±0.5pF	GJM0222C1E6R4DB01#				±0.1pF	GJM0222C1E7R8BB01#
		6.5pF	±0.05pF	GJM0222C1E6R5WB01#				±0.25pF	GJM0222C1E7R8CB01#
			±0.1pF	GJM0222C1E6R5BB01#				±0.5pF	GJM0222C1E7R8DB01#
			±0.25pF	GJM0222C1E6R5CB01#			7.9pF	±0.05pF	GJM0222C1E7R9WB01#
			±0.5pF	GJM0222C1E6R5DB01#				±0.1pF	GJM0222C1E7R9BB01#
		6.6pF	±0.05pF	GJM0222C1E6R6WB01#				±0.25pF	GJM0222C1E7R9CB01#
			±0.1pF	GJM0222C1E6R6BB01#				±0.5pF	GJM0222C1E7R9DB01#
			±0.25pF	GJM0222C1E6R6CB01#			8.0pF	±0.05pF	GJM0222C1E8R0WB01#
			±0.5pF	GJM0222C1E6R6DB01#				±0.1pF	GJM0222C1E8R0BB01#
		6.7pF	±0.05pF	GJM0222C1E6R7WB01#				±0.25pF	GJM0222C1E8R0CB01#
			±0.1pF	GJM0222C1E6R7BB01#				±0.5pF	GJM0222C1E8R0DB01#
			±0.25pF	GJM0222C1E6R7CB01#			8.1pF	±0.05pF	GJM0222C1E8R1WB01#
			±0.5pF	GJM0222C1E6R7DB01#				±0.1pF	GJM0222C1E8R1BB01#
		6.8pF	±0.05pF	GJM0222C1E6R8WB01#				±0.25pF	GJM0222C1E8R1CB01#
			±0.1pF	GJM0222C1E6R8BB01#				±0.5pF	GJM0222C1E8R1DB01#
			±0.25pF	GJM0222C1E6R8CB01#			8.2pF	±0.05pF	GJM0222C1E8R2WB01#
			±0.5pF	GJM0222C1E6R8DB01#				±0.1pF	GJM0222C1E8R2BB01#
		6.9pF	±0.05pF	GJM0222C1E6R9WB01#				±0.25pF	GJM0222C1E8R2CB01#
			±0.1pF	GJM0222C1E6R9BB01#				±0.5pF	GJM0222C1E8R2DB01#
			±0.25pF	GJM0222C1E6R9CB01#			8.3pF	±0.05pF	GJM0222C1E8R3WB01#
			±0.5pF	GJM0222C1E6R9DB01#				±0.1pF	GJM0222C1E8R3BB01#
		7.0pF	±0.05pF	GJM0222C1E7R0WB01#				±0.25pF	GJM0222C1E8R3CB01#
			±0.1pF	GJM0222C1E7R0BB01#				±0.5pF	GJM0222C1E8R3DB01#
			±0.25pF	GJM0222C1E7R0CB01#			8.4pF	±0.05pF	GJM0222C1E8R4WB01#
			±0.5pF	GJM0222C1E7R0DB01#				±0.1pF	GJM0222C1E8R4BB01#
		7.1pF	±0.05pF	GJM0222C1E7R1WB01#				±0.25pF	GJM0222C1E8R4CB01#
			±0.1pF	GJM0222C1E7R1BB01#				±0.5pF	GJM0222C1E8R4DB01#
			±0.25pF	GJM0222C1E7R1CB01#			8.5pF	±0.05pF	GJM0222C1E8R5WB01#
			±0.5pF	GJM0222C1E7R1DB01#				±0.1pF	GJM0222C1E8R5BB01#
		7.2pF	±0.05pF	GJM0222C1E7R2WB01#				±0.25pF	GJM0222C1E8R5CB01#
			±0.1pF	GJM0222C1E7R2BB01#				±0.5pF	GJM0222C1E8R5DB01#
			±0.25pF	GJM0222C1E7R2CB01#			8.6pF	±0.05pF	GJM0222C1E8R6WB01#
			±0.5pF	GJM0222C1E7R2DB01#				±0.1pF	GJM0222C1E8R6BB01#
		7.3pF	±0.05pF	GJM0222C1E7R3WB01#				±0.25pF	GJM0222C1E8R6CB01#
			±0.1pF	GJM0222C1E7R3BB01#				±0.5pF	GJM0222C1E8R6DB01#
			±0.25pF	GJM0222C1E7R3CB01#			8.7pF	±0.05pF	GJM0222C1E8R7WB01#
			±0.5pF	GJM0222C1E7R3DB01#				±0.1pF	GJM0222C1E8R7BB01#
		7.4pF	±0.05pF	GJM0222C1E7R4WB01#				±0.25pF	GJM0222C1E8R7CB01#
			±0.1pF	GJM0222C1E7R4BB01#				±0.5pF	GJM0222C1E8R7DB01#
			±0.25pF	GJM0222C1E7R4CB01#			8.8pF	±0.05pF	GJM0222C1E8R8WB01#
			±0.5pF	GJM0222C1E7R4DB01#				±0.1pF	GJM0222C1E8R8BB01#
		7.5pF	±0.05pF	GJM0222C1E7R5WB01#				±0.25pF	GJM0222C1E8R8CB01#

Part number # indicates the package specification code.

- GRM
- GR3
- GRJ
- GR4
- GJM
- GQM
- GQ2
- GA2
- GA3
- GA3
- GA3
- GA3
- GA3
- LL3
- LLA
- LLM
- LLR
- NFM
- GJ4
- ZRA
- ZRB
- KRM
- KR3
- GMA
- GMD
- ⚠Caution /Notice

GJM Series Temperature Compensating Type **High Q** Part Number List

(→ 0.4×0.2mm)

Rated Voltage	TC Code	Cap.	Tol.	Part Number	Rated Voltage	TC Code	Cap.	Tol.	Part Number	
25Vdc	CH	8.8pF	±0.5pF	GJM0222C1E8R8DB01#	25Vdc	CH	15pF	±5%	GJM0222C1E150JB01#	
			±0.05pF	GJM0222C1E8R9WB01#				16pF	±2%	GJM0222C1E160GB01#
			±0.1pF	GJM0222C1E8R9BB01#			±5%		GJM0222C1E160JB01#	
			±0.25pF	GJM0222C1E8R9CB01#			18pF	±2%	GJM0222C1E180GB01#	
		±0.5pF	GJM0222C1E8R9DB01#	±5%				GJM0222C1E180JB01#		
		9.0pF	±0.05pF	GJM0222C1E9R0WB01#			20pF	±2%	GJM0222C1E200GB01#	
			±0.1pF	GJM0222C1E9R0BB01#				±5%	GJM0222C1E200JB01#	
			±0.25pF	GJM0222C1E9R0CB01#			22pF	±2%	GJM0222C1E220GB01#	
			±0.5pF	GJM0222C1E9R0DB01#				±5%	GJM0222C1E220JB01#	
		9.1pF	±0.05pF	GJM0222C1E9R1WB01#			CJ	2.1pF	±0.05pF	GJM0223C1E2R1WB01#
			±0.1pF	GJM0222C1E9R1BB01#					±0.1pF	GJM0223C1E2R1BB01#
			±0.25pF	GJM0222C1E9R1CB01#					±0.25pF	GJM0223C1E2R1CB01#
			±0.5pF	GJM0222C1E9R1DB01#				2.2pF	±0.05pF	GJM0223C1E2R2WB01#
		±0.05pF	GJM0222C1E9R2WB01#	±0.1pF					GJM0223C1E2R2BB01#	
		±0.1pF	GJM0222C1E9R2BB01#	±0.25pF					GJM0223C1E2R2CB01#	
		±0.25pF	GJM0222C1E9R2CB01#	2.3pF				±0.05pF	GJM0223C1E2R3WB01#	
		±0.5pF	GJM0222C1E9R2DB01#					±0.1pF	GJM0223C1E2R3BB01#	
		±0.25pF	GJM0222C1E9R3WB01#					±0.25pF	GJM0223C1E2R3CB01#	
		±0.05pF	GJM0222C1E9R3BB01#	2.4pF				±0.05pF	GJM0223C1E2R4WB01#	
		±0.1pF	GJM0222C1E9R3CB01#					±0.1pF	GJM0223C1E2R4BB01#	
		±0.25pF	GJM0222C1E9R3DB01#					±0.25pF	GJM0223C1E2R4CB01#	
		±0.5pF	GJM0222C1E9R4WB01#	2.5pF				±0.05pF	GJM0223C1E2R5WB01#	
		±0.1pF	GJM0222C1E9R4BB01#					±0.1pF	GJM0223C1E2R5BB01#	
		±0.25pF	GJM0222C1E9R4CB01#					±0.25pF	GJM0223C1E2R5CB01#	
		±0.5pF	GJM0222C1E9R4DB01#	2.6pF		±0.05pF		GJM0223C1E2R6WB01#		
		±0.05pF	GJM0222C1E9R5WB01#			±0.1pF		GJM0223C1E2R6BB01#		
		±0.1pF	GJM0222C1E9R5BB01#			±0.25pF		GJM0223C1E2R6CB01#		
		±0.25pF	GJM0222C1E9R5CB01#	2.7pF		±0.05pF		GJM0223C1E2R7WB01#		
		±0.5pF	GJM0222C1E9R5DB01#			±0.1pF		GJM0223C1E2R7BB01#		
		±0.05pF	GJM0222C1E9R6WB01#			±0.25pF		GJM0223C1E2R7CB01#		
		±0.1pF	GJM0222C1E9R6BB01#	2.8pF		±0.05pF		GJM0223C1E2R8WB01#		
		±0.25pF	GJM0222C1E9R6CB01#			±0.1pF		GJM0223C1E2R8BB01#		
		±0.5pF	GJM0222C1E9R6DB01#			±0.25pF		GJM0223C1E2R8CB01#		
		±0.05pF	GJM0222C1E9R7WB01#	2.9pF		±0.05pF	GJM0223C1E2R9WB01#			
		±0.1pF	GJM0222C1E9R7BB01#			±0.1pF	GJM0223C1E2R9BB01#			
		±0.25pF	GJM0222C1E9R7CB01#			±0.25pF	GJM0223C1E2R9CB01#			
		±0.5pF	GJM0222C1E9R7DB01#	3.0pF		±0.05pF	GJM0223C1E3R0WB01#			
		±0.05pF	GJM0222C1E9R8WB01#			±0.1pF	GJM0223C1E3R0BB01#			
		±0.1pF	GJM0222C1E9R8BB01#			±0.25pF	GJM0223C1E3R0CB01#			
		±0.25pF	GJM0222C1E9R8CB01#	3.1pF		±0.05pF	GJM0223C1E3R1WB01#			
		±0.5pF	GJM0222C1E9R8DB01#			±0.1pF	GJM0223C1E3R1BB01#			
		±0.05pF	GJM0222C1E9R9WB01#			±0.25pF	GJM0223C1E3R1CB01#			
		±0.1pF	GJM0222C1E9R9BB01#	3.2pF		±0.05pF	GJM0223C1E3R2WB01#			
		±0.25pF	GJM0222C1E9R9CB01#			±0.1pF	GJM0223C1E3R2BB01#			
		±0.5pF	GJM0222C1E9R9DB01#			±0.25pF	GJM0223C1E3R2CB01#			
		±2%	GJM0222C1E100GB01#	10pF		±0.05pF	GJM0223C1E3R3WB01#			
		±5%	GJM0222C1E100JB01#			±0.1pF	GJM0223C1E3R3BB01#			
		±2%	GJM0222C1E110GB01#	11pF		±0.25pF	GJM0223C1E3R3CB01#			
		±5%	GJM0222C1E110JB01#			3.4pF	±0.05pF	GJM0223C1E3R4WB01#		
		±2%	GJM0222C1E120GB01#	±0.1pF			GJM0223C1E3R4BB01#			
		±5%	GJM0222C1E120JB01#	12pF		±0.25pF	GJM0223C1E3R4CB01#			
		±2%	GJM0222C1E130GB01#			3.5pF	±0.05pF	GJM0223C1E3R5WB01#		
±5%	GJM0222C1E130JB01#	±0.1pF	GJM0223C1E3R5BB01#							
±2%	GJM0222C1E150GB01#	15pF	±0.25pF	GJM0223C1E3R5CB01#						

- GRM
- GR3
- GRJ
- GR4
- GJM
- GQM
- GA2
- GA3 GB
- GA3 GD
- GA3 GF
- LLL
- LLA
- LLM
- LLR
- NFM
- GJ4
- ZRA
- ZRB
- KRM
- KR3
- GMA
- GMD
- ⚠Caution /Notice

Part number # indicates the package specification code.

GJM Series Temperature Compensating Type **High Q** Part Number List

(→ 0.4×0.2mm)

Rated Voltage	TC Code	Cap.	Tol.	Part Number		Rated Voltage	TC Code	Cap.	Tol.	Part Number		
25Vdc	CJ	3.6pF	±0.05pF	GJM0223C1E3R6WB01#		25Vdc	CK	1.8pF	±0.25pF	GJM0224C1E1R8CB01#		
			±0.1pF	GJM0223C1E3R6BB01#					1.9pF	±0.05pF	GJM0224C1E1R9WB01#	
			±0.25pF	GJM0223C1E3R6CB01#						±0.1pF	GJM0224C1E1R9BB01#	
		3.7pF	±0.05pF	GJM0223C1E3R7WB01#				±0.25pF		GJM0224C1E1R9CB01#		
			±0.1pF	GJM0223C1E3R7BB01#				2.0pF	±0.05pF	GJM0224C1E2R0WB01#		
			±0.25pF	GJM0223C1E3R7CB01#					±0.1pF	GJM0224C1E2R0BB01#		
		3.8pF	±0.05pF	GJM0223C1E3R8WB01#					±0.25pF	GJM0224C1E2R0CB01#		
			±0.1pF	GJM0223C1E3R8BB01#				X8G	0.20pF	±0.05pF	GJM0225G1ER20WB01#	D1
			±0.25pF	GJM0223C1E3R8CB01#						±0.1pF	GJM0225G1ER20BB01#	D1
		3.9pF	±0.05pF	GJM0223C1E3R9WB01#					0.25pF	±0.05pF	GJM0225G1ER25WB01#	D1
			±0.1pF	GJM0223C1E3R9BB01#						±0.1pF	GJM0225G1ER25BB01#	D1
			±0.25pF	GJM0223C1E3R9CB01#					0.30pF	±0.05pF	GJM0225G1ER30WB01#	D1
		0.20pF	±0.05pF	GJM0224C1ER20WB01#						±0.1pF	GJM0225G1ER30BB01#	D1
			±0.1pF	GJM0224C1ER20BB01#					0.35pF	±0.05pF	GJM0225G1ER35WB01#	D1
			0.30pF	±0.05pF	GJM0224C1ER30WB01#						±0.1pF	GJM0225G1ER35BB01#
		±0.1pF		GJM0224C1ER30BB01#					0.40pF	±0.05pF	GJM0225G1ER40WB01#	D1
		0.40pF	±0.05pF	GJM0224C1ER40WB01#						±0.1pF	GJM0225G1ER40BB01#	D1
			±0.1pF	GJM0224C1ER40BB01#					0.45pF	±0.05pF	GJM0225G1ER45WB01#	D1
	0.50pF	±0.05pF	GJM0224C1ER50WB01#		±0.1pF	GJM0225G1ER45BB01#	D1					
		±0.1pF	GJM0224C1ER50BB01#		0.50pF	±0.05pF	GJM0225G1ER50WB01#		D1			
	0.60pF	±0.05pF	GJM0224C1ER60WB01#			±0.1pF	GJM0225G1ER50BB01#		D1			
		±0.1pF	GJM0224C1ER60BB01#		0.55pF	±0.05pF	GJM0225G1ER55WB01#		D1			
	0.70pF	±0.05pF	GJM0224C1ER70WB01#			±0.1pF	GJM0225G1ER55BB01#		D1			
		±0.1pF	GJM0224C1ER70BB01#		0.60pF	±0.05pF	GJM0225G1ER60WB01#		D1			
	0.80pF	±0.05pF	GJM0224C1ER80WB01#			±0.1pF	GJM0225G1ER60BB01#		D1			
		±0.1pF	GJM0224C1ER80BB01#		0.65pF	±0.05pF	GJM0225G1ER65WB01#	D1				
	0.90pF	±0.05pF	GJM0224C1ER90WB01#			±0.1pF	GJM0225G1ER65BB01#	D1				
		±0.1pF	GJM0224C1ER90BB01#		0.70pF	±0.05pF	GJM0225G1ER70WB01#	D1				
	1.0pF	±0.05pF	GJM0224C1E1R0WB01#			±0.1pF	GJM0225G1ER70BB01#	D1				
		±0.1pF	GJM0224C1E1R0BB01#		0.75pF	±0.05pF	GJM0225G1ER75WB01#	D1				
		±0.25pF	GJM0224C1E1R0CB01#			±0.1pF	GJM0225G1ER75BB01#	D1				
	1.1pF	±0.05pF	GJM0224C1E1R1WB01#		0.80pF	±0.05pF	GJM0225G1ER80WB01#	D1				
		±0.1pF	GJM0224C1E1R1BB01#			±0.1pF	GJM0225G1ER80BB01#	D1				
		±0.25pF	GJM0224C1E1R1CB01#		0.85pF	±0.05pF	GJM0225G1ER85WB01#	D1				
	1.2pF	±0.05pF	GJM0224C1E1R2WB01#			±0.1pF	GJM0225G1ER85BB01#	D1				
		±0.1pF	GJM0224C1E1R2BB01#		0.90pF	±0.05pF	GJM0225G1ER90WB01#	D1				
±0.25pF		GJM0224C1E1R2CB01#		±0.1pF		GJM0225G1ER90BB01#	D1					
1.3pF	±0.05pF	GJM0224C1E1R3WB01#		0.95pF	±0.05pF	GJM0225G1ER95WB01#	D1					
	±0.1pF	GJM0224C1E1R3BB01#			±0.1pF	GJM0225G1ER95BB01#	D1					
	±0.25pF	GJM0224C1E1R3CB01#		1.0pF	±0.05pF	GJM0225G1E1R0WB01#	D1					
1.4pF	±0.05pF	GJM0224C1E1R4WB01#			±0.1pF	GJM0225G1E1R0BB01#	D1					
	±0.1pF	GJM0224C1E1R4BB01#			±0.25pF	GJM0225G1E1R0CB01#	D1					
	±0.25pF	GJM0224C1E1R4CB01#		1.1pF	±0.05pF	GJM0225G1E1R1WB01#	D1					
1.5pF	±0.05pF	GJM0224C1E1R5WB01#			±0.1pF	GJM0225G1E1R1BB01#	D1					
	±0.1pF	GJM0224C1E1R5BB01#			±0.25pF	GJM0225G1E1R1CB01#	D1					
	±0.25pF	GJM0224C1E1R5CB01#		1.2pF	±0.05pF	GJM0225G1E1R2WB01#	D1					
1.6pF	±0.05pF	GJM0224C1E1R6WB01#			±0.1pF	GJM0225G1E1R2BB01#	D1					
	±0.1pF	GJM0224C1E1R6BB01#			±0.25pF	GJM0225G1E1R2CB01#	D1					
	±0.25pF	GJM0224C1E1R6CB01#		1.3pF	±0.05pF	GJM0225G1E1R3WB01#	D1					
1.7pF	±0.05pF	GJM0224C1E1R7WB01#			±0.1pF	GJM0225G1E1R3BB01#	D1					
	±0.1pF	GJM0224C1E1R7BB01#			±0.25pF	GJM0225G1E1R3CB01#	D1					
	±0.25pF	GJM0224C1E1R7CB01#		1.4pF	±0.05pF	GJM0225G1E1R4WB01#	D1					
1.8pF	±0.05pF	GJM0224C1E1R8WB01#			±0.1pF	GJM0225G1E1R4BB01#	D1					
	±0.1pF	GJM0224C1E1R8BB01#			±0.25pF	GJM0225G1E1R4CB01#	D1					

- GRM
- GR3
- GRJ
- GR4
- GJM
- GQM
- GQ2
- GA2
- GA3 GB
- GA3 GD
- GA3 GF
- LLL
- LLA
- LLM
- LLR
- NFM
- GJ4
- ZRA
- ZRB
- KRM
- KR3
- GMA
- GMD
- ⚠Caution /Notice

Part number # indicates the package specification code.

GJM Series Temperature Compensating Type **High Q** Part Number List

(→ 0.4×0.2mm)

Rated Voltage	TC Code	Cap.	Tol.	Part Number		Rated Voltage	TC Code	Cap.	Tol.	Part Number	
25Vdc	X8G	1.5pF	±0.05pF	GJM0225G1E1R5WB01#	D1	25Vdc	X8G	3.3pF	±0.05pF	GJM0225G1E3R3WB01#	D1
			±0.1pF	GJM0225G1E1R5BB01#	D1				±0.1pF	GJM0225G1E3R3BB01#	D1
			±0.25pF	GJM0225G1E1R5CB01#	D1				±0.25pF	GJM0225G1E3R3CB01#	D1
		1.6pF	±0.05pF	GJM0225G1E1R6WB01#	D1			3.4pF	±0.05pF	GJM0225G1E3R4WB01#	D1
			±0.1pF	GJM0225G1E1R6BB01#	D1				±0.1pF	GJM0225G1E3R4BB01#	D1
			±0.25pF	GJM0225G1E1R6CB01#	D1				±0.25pF	GJM0225G1E3R4CB01#	D1
		1.7pF	±0.05pF	GJM0225G1E1R7WB01#	D1			3.5pF	±0.05pF	GJM0225G1E3R5WB01#	D1
			±0.1pF	GJM0225G1E1R7BB01#	D1				±0.1pF	GJM0225G1E3R5BB01#	D1
			±0.25pF	GJM0225G1E1R7CB01#	D1				±0.25pF	GJM0225G1E3R5CB01#	D1
		1.8pF	±0.05pF	GJM0225G1E1R8WB01#	D1			3.6pF	±0.05pF	GJM0225G1E3R6WB01#	D1
			±0.1pF	GJM0225G1E1R8BB01#	D1				±0.1pF	GJM0225G1E3R6BB01#	D1
			±0.25pF	GJM0225G1E1R8CB01#	D1				±0.25pF	GJM0225G1E3R6CB01#	D1
		1.9pF	±0.05pF	GJM0225G1E1R9WB01#	D1			3.7pF	±0.05pF	GJM0225G1E3R7WB01#	D1
			±0.1pF	GJM0225G1E1R9BB01#	D1				±0.1pF	GJM0225G1E3R7BB01#	D1
			±0.25pF	GJM0225G1E1R9CB01#	D1				±0.25pF	GJM0225G1E3R7CB01#	D1
		2.0pF	±0.05pF	GJM0225G1E2R0WB01#	D1			3.8pF	±0.05pF	GJM0225G1E3R8WB01#	D1
			±0.1pF	GJM0225G1E2R0BB01#	D1				±0.1pF	GJM0225G1E3R8BB01#	D1
			±0.25pF	GJM0225G1E2R0CB01#	D1				±0.25pF	GJM0225G1E3R8CB01#	D1
		2.1pF	±0.05pF	GJM0225G1E2R1WB01#	D1			3.9pF	±0.05pF	GJM0225G1E3R9WB01#	D1
			±0.1pF	GJM0225G1E2R1BB01#	D1				±0.1pF	GJM0225G1E3R9BB01#	D1
			±0.25pF	GJM0225G1E2R1CB01#	D1				±0.25pF	GJM0225G1E3R9CB01#	D1
		2.2pF	±0.05pF	GJM0225G1E2R2WB01#	D1			4.0pF	±0.05pF	GJM0225G1E4R0WB01#	D1
			±0.1pF	GJM0225G1E2R2BB01#	D1				±0.1pF	GJM0225G1E4R0BB01#	D1
			±0.25pF	GJM0225G1E2R2CB01#	D1				±0.25pF	GJM0225G1E4R0CB01#	D1
		2.3pF	±0.05pF	GJM0225G1E2R3WB01#	D1			4.1pF	±0.05pF	GJM0225G1E4R1WB01#	D1
			±0.1pF	GJM0225G1E2R3BB01#	D1				±0.1pF	GJM0225G1E4R1BB01#	D1
			±0.25pF	GJM0225G1E2R3CB01#	D1				±0.25pF	GJM0225G1E4R1CB01#	D1
		2.4pF	±0.05pF	GJM0225G1E2R4WB01#	D1			4.2pF	±0.05pF	GJM0225G1E4R2WB01#	D1
			±0.1pF	GJM0225G1E2R4BB01#	D1				±0.1pF	GJM0225G1E4R2BB01#	D1
			±0.25pF	GJM0225G1E2R4CB01#	D1				±0.25pF	GJM0225G1E4R2CB01#	D1
		2.5pF	±0.05pF	GJM0225G1E2R5WB01#	D1			4.3pF	±0.05pF	GJM0225G1E4R3WB01#	D1
			±0.1pF	GJM0225G1E2R5BB01#	D1				±0.1pF	GJM0225G1E4R3BB01#	D1
			±0.25pF	GJM0225G1E2R5CB01#	D1				±0.25pF	GJM0225G1E4R3CB01#	D1
		2.6pF	±0.05pF	GJM0225G1E2R6WB01#	D1			4.4pF	±0.05pF	GJM0225G1E4R4WB01#	D1
			±0.1pF	GJM0225G1E2R6BB01#	D1				±0.1pF	GJM0225G1E4R4BB01#	D1
			±0.25pF	GJM0225G1E2R6CB01#	D1				±0.25pF	GJM0225G1E4R4CB01#	D1
		2.7pF	±0.05pF	GJM0225G1E2R7WB01#	D1			4.5pF	±0.05pF	GJM0225G1E4R5WB01#	D1
			±0.1pF	GJM0225G1E2R7BB01#	D1				±0.1pF	GJM0225G1E4R5BB01#	D1
			±0.25pF	GJM0225G1E2R7CB01#	D1				±0.25pF	GJM0225G1E4R5CB01#	D1
		2.8pF	±0.05pF	GJM0225G1E2R8WB01#	D1			4.6pF	±0.05pF	GJM0225G1E4R6WB01#	D1
			±0.1pF	GJM0225G1E2R8BB01#	D1				±0.1pF	GJM0225G1E4R6BB01#	D1
			±0.25pF	GJM0225G1E2R8CB01#	D1				±0.25pF	GJM0225G1E4R6CB01#	D1
		2.9pF	±0.05pF	GJM0225G1E2R9WB01#	D1			4.7pF	±0.05pF	GJM0225G1E4R7WB01#	D1
			±0.1pF	GJM0225G1E2R9BB01#	D1				±0.1pF	GJM0225G1E4R7BB01#	D1
			±0.25pF	GJM0225G1E2R9CB01#	D1				±0.25pF	GJM0225G1E4R7CB01#	D1
		3.0pF	±0.05pF	GJM0225G1E3R0WB01#	D1			4.8pF	±0.05pF	GJM0225G1E4R8WB01#	D1
			±0.1pF	GJM0225G1E3R0BB01#	D1				±0.1pF	GJM0225G1E4R8BB01#	D1
			±0.25pF	GJM0225G1E3R0CB01#	D1				±0.25pF	GJM0225G1E4R8CB01#	D1
3.1pF	±0.05pF	GJM0225G1E3R1WB01#	D1	4.9pF	±0.05pF	GJM0225G1E4R9WB01#	D1				
	±0.1pF	GJM0225G1E3R1BB01#	D1		±0.1pF	GJM0225G1E4R9BB01#	D1				
	±0.25pF	GJM0225G1E3R1CB01#	D1		±0.25pF	GJM0225G1E4R9CB01#	D1				
3.2pF	±0.05pF	GJM0225G1E3R2WB01#	D1	5.0pF	±0.05pF	GJM0225G1E5R0WB01#	D1				
	±0.1pF	GJM0225G1E3R2BB01#	D1		±0.1pF	GJM0225G1E5R0BB01#	D1				
	±0.25pF	GJM0225G1E3R2CB01#	D1		±0.25pF	GJM0225G1E5R0CB01#	D1				

Part number # indicates the package specification code.

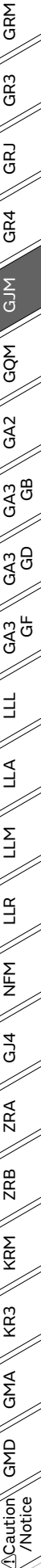

GJM Series Temperature Compensating Type **High Q** Part Number List

(→ 0.4×0.2mm)

Rated Voltage	TC Code	Cap.	Tol.	Part Number		Rated Voltage	TC Code	Cap.	Tol.	Part Number		
25Vdc	X8G	5.1pF	±0.05pF	GJM0225G1E5R1WB01#	D1	25Vdc	X8G	6.4pF	±0.25pF	GJM0225G1E6R4CB01#	D1	
			±0.1pF	GJM0225G1E5R1BB01#	D1				±0.5pF	GJM0225G1E6R4DB01#	D1	
			±0.25pF	GJM0225G1E5R1CB01#	D1				6.5pF	±0.05pF	GJM0225G1E6R5WB01#	D1
			±0.5pF	GJM0225G1E5R1DB01#	D1					±0.1pF	GJM0225G1E6R5BB01#	D1
		5.2pF	±0.05pF	GJM0225G1E5R2WB01#	D1			±0.25pF		GJM0225G1E6R5CB01#	D1	
			±0.1pF	GJM0225G1E5R2BB01#	D1			±0.5pF		GJM0225G1E6R5DB01#	D1	
			±0.25pF	GJM0225G1E5R2CB01#	D1			6.6pF	±0.05pF	GJM0225G1E6R6WB01#	D1	
			±0.5pF	GJM0225G1E5R2DB01#	D1				±0.1pF	GJM0225G1E6R6BB01#	D1	
		5.3pF	±0.05pF	GJM0225G1E5R3WB01#	D1				±0.25pF	GJM0225G1E6R6CB01#	D1	
			±0.1pF	GJM0225G1E5R3BB01#	D1				±0.5pF	GJM0225G1E6R6DB01#	D1	
			±0.25pF	GJM0225G1E5R3CB01#	D1			6.7pF	±0.05pF	GJM0225G1E6R7WB01#	D1	
			±0.5pF	GJM0225G1E5R3DB01#	D1				±0.1pF	GJM0225G1E6R7BB01#	D1	
		5.4pF	±0.05pF	GJM0225G1E5R4WB01#	D1				±0.25pF	GJM0225G1E6R7CB01#	D1	
			±0.1pF	GJM0225G1E5R4BB01#	D1				±0.5pF	GJM0225G1E6R7DB01#	D1	
			±0.25pF	GJM0225G1E5R4CB01#	D1			6.8pF	±0.05pF	GJM0225G1E6R8WB01#	D1	
			±0.5pF	GJM0225G1E5R4DB01#	D1				±0.1pF	GJM0225G1E6R8BB01#	D1	
		5.5pF	±0.05pF	GJM0225G1E5R5WB01#	D1				±0.25pF	GJM0225G1E6R8CB01#	D1	
			±0.1pF	GJM0225G1E5R5BB01#	D1				±0.5pF	GJM0225G1E6R8DB01#	D1	
			±0.25pF	GJM0225G1E5R5CB01#	D1			6.9pF	±0.05pF	GJM0225G1E6R9WB01#	D1	
			±0.5pF	GJM0225G1E5R5DB01#	D1				±0.1pF	GJM0225G1E6R9BB01#	D1	
		5.6pF	±0.05pF	GJM0225G1E5R6WB01#	D1				±0.25pF	GJM0225G1E6R9CB01#	D1	
			±0.1pF	GJM0225G1E5R6BB01#	D1				±0.5pF	GJM0225G1E6R9DB01#	D1	
			±0.25pF	GJM0225G1E5R6CB01#	D1			7.0pF	±0.05pF	GJM0225G1E7R0WB01#	D1	
			±0.5pF	GJM0225G1E5R6DB01#	D1				±0.1pF	GJM0225G1E7R0BB01#	D1	
		5.7pF	±0.05pF	GJM0225G1E5R7WB01#	D1				±0.25pF	GJM0225G1E7R0CB01#	D1	
			±0.1pF	GJM0225G1E5R7BB01#	D1				±0.5pF	GJM0225G1E7R0DB01#	D1	
			±0.25pF	GJM0225G1E5R7CB01#	D1			7.1pF	±0.05pF	GJM0225G1E7R1WB01#	D1	
			±0.5pF	GJM0225G1E5R7DB01#	D1				±0.1pF	GJM0225G1E7R1BB01#	D1	
		5.8pF	±0.05pF	GJM0225G1E5R8WB01#	D1				±0.25pF	GJM0225G1E7R1CB01#	D1	
			±0.1pF	GJM0225G1E5R8BB01#	D1				±0.5pF	GJM0225G1E7R1DB01#	D1	
			±0.25pF	GJM0225G1E5R8CB01#	D1			7.2pF	±0.05pF	GJM0225G1E7R2WB01#	D1	
			±0.5pF	GJM0225G1E5R8DB01#	D1				±0.1pF	GJM0225G1E7R2BB01#	D1	
		5.9pF	±0.05pF	GJM0225G1E5R9WB01#	D1				±0.25pF	GJM0225G1E7R2CB01#	D1	
			±0.1pF	GJM0225G1E5R9BB01#	D1				±0.5pF	GJM0225G1E7R2DB01#	D1	
			±0.25pF	GJM0225G1E5R9CB01#	D1			7.3pF	±0.05pF	GJM0225G1E7R3WB01#	D1	
			±0.5pF	GJM0225G1E5R9DB01#	D1				±0.1pF	GJM0225G1E7R3BB01#	D1	
		6.0pF	±0.05pF	GJM0225G1E6R0WB01#	D1				±0.25pF	GJM0225G1E7R3CB01#	D1	
			±0.1pF	GJM0225G1E6R0BB01#	D1				±0.5pF	GJM0225G1E7R3DB01#	D1	
			±0.25pF	GJM0225G1E6R0CB01#	D1			7.4pF	±0.05pF	GJM0225G1E7R4WB01#	D1	
			±0.5pF	GJM0225G1E6R0DB01#	D1				±0.1pF	GJM0225G1E7R4BB01#	D1	
		6.1pF	±0.05pF	GJM0225G1E6R1WB01#	D1				±0.25pF	GJM0225G1E7R4CB01#	D1	
			±0.1pF	GJM0225G1E6R1BB01#	D1				±0.5pF	GJM0225G1E7R4DB01#	D1	
			±0.25pF	GJM0225G1E6R1CB01#	D1			7.5pF	±0.05pF	GJM0225G1E7R5WB01#	D1	
			±0.5pF	GJM0225G1E6R1DB01#	D1				±0.1pF	GJM0225G1E7R5BB01#	D1	
		6.2pF	±0.05pF	GJM0225G1E6R2WB01#	D1				±0.25pF	GJM0225G1E7R5CB01#	D1	
			±0.1pF	GJM0225G1E6R2BB01#	D1				±0.5pF	GJM0225G1E7R5DB01#	D1	
			±0.25pF	GJM0225G1E6R2CB01#	D1			7.6pF	±0.05pF	GJM0225G1E7R6WB01#	D1	
			±0.5pF	GJM0225G1E6R2DB01#	D1				±0.1pF	GJM0225G1E7R6BB01#	D1	
		6.3pF	±0.05pF	GJM0225G1E6R3WB01#	D1				±0.25pF	GJM0225G1E7R6CB01#	D1	
			±0.1pF	GJM0225G1E6R3BB01#	D1				±0.5pF	GJM0225G1E7R6DB01#	D1	
			±0.25pF	GJM0225G1E6R3CB01#	D1			7.7pF	±0.05pF	GJM0225G1E7R7WB01#	D1	
			±0.5pF	GJM0225G1E6R3DB01#	D1				±0.1pF	GJM0225G1E7R7BB01#	D1	
		6.4pF	±0.05pF	GJM0225G1E6R4WB01#	D1				±0.25pF	GJM0225G1E7R7CB01#	D1	
			±0.1pF	GJM0225G1E6R4BB01#	D1				±0.5pF	GJM0225G1E7R7DB01#	D1	

Part number # indicates the package specification code.

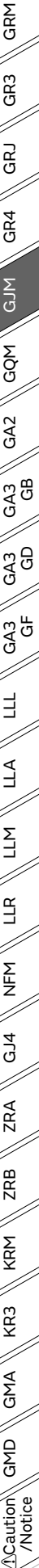

GJM Series Temperature Compensating Type **High Q** Part Number List

(→ 0.4×0.2mm)

Rated Voltage	TC Code	Cap.	Tol.	Part Number		Rated Voltage	TC Code	Cap.	Tol.	Part Number	
25Vdc	X8G	7.8pF	±0.05pF	GJM0225G1E7R8WB01#	D1	25Vdc	X8G	9.1pF	±0.25pF	GJM0225G1E9R1CB01#	D1
			±0.1pF	GJM0225G1E7R8BB01#	D1				±0.5pF	GJM0225G1E9R1DB01#	D1
			±0.25pF	GJM0225G1E7R8CB01#	D1			9.2pF	±0.05pF	GJM0225G1E9R2WB01#	D1
			±0.5pF	GJM0225G1E7R8DB01#	D1				±0.1pF	GJM0225G1E9R2BB01#	D1
		±0.05pF	GJM0225G1E7R9WB01#	D1	±0.25pF				GJM0225G1E9R2CB01#	D1	
		±0.1pF	GJM0225G1E7R9BB01#	D1	±0.5pF				GJM0225G1E9R2DB01#	D1	
		7.9pF	±0.25pF	GJM0225G1E7R9CB01#	D1			9.3pF	±0.05pF	GJM0225G1E9R3WB01#	D1
			±0.5pF	GJM0225G1E7R9DB01#	D1				±0.1pF	GJM0225G1E9R3BB01#	D1
			±0.05pF	GJM0225G1E8R0WB01#	D1				±0.25pF	GJM0225G1E9R3CB01#	D1
			±0.1pF	GJM0225G1E8R0BB01#	D1				±0.5pF	GJM0225G1E9R3DB01#	D1
		8.0pF	±0.25pF	GJM0225G1E8R0CB01#	D1			9.4pF	±0.05pF	GJM0225G1E9R4WB01#	D1
			±0.5pF	GJM0225G1E8R0DB01#	D1				±0.1pF	GJM0225G1E9R4BB01#	D1
			±0.05pF	GJM0225G1E8R1WB01#	D1				±0.25pF	GJM0225G1E9R4CB01#	D1
			±0.1pF	GJM0225G1E8R1BB01#	D1				±0.5pF	GJM0225G1E9R4DB01#	D1
		8.1pF	±0.25pF	GJM0225G1E8R1CB01#	D1			9.5pF	±0.05pF	GJM0225G1E9R5WB01#	D1
			±0.5pF	GJM0225G1E8R1DB01#	D1				±0.1pF	GJM0225G1E9R5BB01#	D1
			±0.05pF	GJM0225G1E8R2WB01#	D1				±0.25pF	GJM0225G1E9R5CB01#	D1
			±0.1pF	GJM0225G1E8R2BB01#	D1				±0.5pF	GJM0225G1E9R5DB01#	D1
		8.2pF	±0.25pF	GJM0225G1E8R2CB01#	D1			9.6pF	±0.05pF	GJM0225G1E9R6WB01#	D1
			±0.5pF	GJM0225G1E8R2DB01#	D1				±0.1pF	GJM0225G1E9R6BB01#	D1
			±0.05pF	GJM0225G1E8R3WB01#	D1				±0.25pF	GJM0225G1E9R6CB01#	D1
			±0.1pF	GJM0225G1E8R3BB01#	D1				±0.5pF	GJM0225G1E9R6DB01#	D1
		8.3pF	±0.25pF	GJM0225G1E8R3CB01#	D1			9.7pF	±0.05pF	GJM0225G1E9R7WB01#	D1
			±0.5pF	GJM0225G1E8R3DB01#	D1				±0.1pF	GJM0225G1E9R7BB01#	D1
			±0.05pF	GJM0225G1E8R4WB01#	D1				±0.25pF	GJM0225G1E9R7CB01#	D1
			±0.1pF	GJM0225G1E8R4BB01#	D1				±0.5pF	GJM0225G1E9R7DB01#	D1
		8.4pF	±0.25pF	GJM0225G1E8R4CB01#	D1			9.8pF	±0.05pF	GJM0225G1E9R8WB01#	D1
			±0.5pF	GJM0225G1E8R4DB01#	D1				±0.1pF	GJM0225G1E9R8BB01#	D1
			±0.05pF	GJM0225G1E8R5WB01#	D1				±0.25pF	GJM0225G1E9R8CB01#	D1
			±0.1pF	GJM0225G1E8R5BB01#	D1				±0.5pF	GJM0225G1E9R8DB01#	D1
		8.5pF	±0.25pF	GJM0225G1E8R5CB01#	D1			9.9pF	±0.05pF	GJM0225G1E9R9WB01#	D1
			±0.5pF	GJM0225G1E8R5DB01#	D1				±0.1pF	GJM0225G1E9R9BB01#	D1
			±0.05pF	GJM0225G1E8R6WB01#	D1				±0.25pF	GJM0225G1E9R9CB01#	D1
			±0.1pF	GJM0225G1E8R6BB01#	D1				±0.5pF	GJM0225G1E9R9DB01#	D1
		8.6pF	±0.25pF	GJM0225G1E8R6CB01#	D1			10pF	±2%	GJM0225G1E100GB01#	D1
			±0.5pF	GJM0225G1E8R6DB01#	D1				±5%	GJM0225G1E100JB01#	D1
			±0.05pF	GJM0225G1E8R7WB01#	D1			11pF	±2%	GJM0225G1E110GB01#	D1
			±0.1pF	GJM0225G1E8R7BB01#	D1				±5%	GJM0225G1E110JB01#	D1
		8.7pF	±0.25pF	GJM0225G1E8R7CB01#	D1			12pF	±2%	GJM0225G1E120GB01#	D1
			±0.5pF	GJM0225G1E8R7DB01#	D1				±5%	GJM0225G1E120JB01#	D1
			±0.05pF	GJM0225G1E8R8WB01#	D1			13pF	±2%	GJM0225G1E130GB01#	D1
			±0.1pF	GJM0225G1E8R8BB01#	D1				±5%	GJM0225G1E130JB01#	D1
		8.8pF	±0.25pF	GJM0225G1E8R8CB01#	D1			14pF	±2%	GJM0225G1E140GB01#	D1
			±0.5pF	GJM0225G1E8R8DB01#	D1				±5%	GJM0225G1E140JB01#	D1
			±0.05pF	GJM0225G1E8R9WB01#	D1			15pF	±2%	GJM0225G1E150GB01#	D1
			±0.1pF	GJM0225G1E8R9BB01#	D1				±5%	GJM0225G1E150JB01#	D1
		8.9pF	±0.25pF	GJM0225G1E8R9CB01#	D1			16pF	±2%	GJM0225G1E160GB01#	D1
			±0.5pF	GJM0225G1E8R9DB01#	D1				±5%	GJM0225G1E160JB01#	D1
			±0.05pF	GJM0225G1E9R0WB01#	D1			17pF	±2%	GJM0225G1E170GB01#	D1
			±0.1pF	GJM0225G1E9R0BB01#	D1				±5%	GJM0225G1E170JB01#	D1
		9.0pF	±0.25pF	GJM0225G1E9R0CB01#	D1			18pF	±2%	GJM0225G1E180GB01#	D1
			±0.5pF	GJM0225G1E9R0DB01#	D1				±5%	GJM0225G1E180JB01#	D1
			±0.05pF	GJM0225G1E9R1WB01#	D1			19pF	±2%	GJM0225G1E190GB01#	D1
			±0.1pF	GJM0225G1E9R1BB01#	D1				±5%	GJM0225G1E190JB01#	D1

Part number # indicates the package specification code.

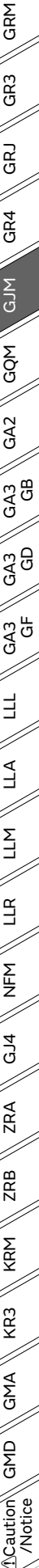

GJM Series Temperature Compensating Type High Q Part Number List

(→ 0.4×0.2mm)

Rated Voltage	TC Code	Cap.	Tol.	Part Number		Rated Voltage	TC Code	Cap.	Tol.	Part Number	
25Vdc	X8G	20pF	±2%	GJM0225G1E200GB01#	D1	16Vdc	COG	2.0pF	±0.25pF	GJM0225C1C2R0CB01#	
			±5%	GJM0225G1E200JB01#	D1				2.1pF	±0.05pF	GJM0225C1C2R1WB01#
		21pF	±2%	GJM0225G1E210GB01#	D1			±0.1pF		GJM0225C1C2R1BB01#	
			±5%	GJM0225G1E210JB01#	D1			±0.25pF	GJM0225C1C2R1CB01#		
		22pF	±2%	GJM0225G1E220GB01#	D1			2.2pF	±0.05pF	GJM0225C1C2R2WB01#	
			±5%	GJM0225G1E220JB01#	D1				±0.1pF	GJM0225C1C2R2BB01#	
16Vdc	COG	0.20pF	±0.05pF	GJM0225C1CR20WB01#		±0.25pF	GJM0225C1C2R2CB01#				
			±0.1pF	GJM0225C1CR20BB01#		2.3pF	±0.05pF	GJM0225C1C2R3WB01#			
		0.30pF	±0.05pF	GJM0225C1CR30WB01#			±0.1pF	GJM0225C1C2R3BB01#			
			±0.1pF	GJM0225C1CR30BB01#		±0.25pF	GJM0225C1C2R3CB01#				
		0.40pF	±0.05pF	GJM0225C1CR40WB01#		2.4pF	±0.05pF	GJM0225C1C2R4WB01#			
			±0.1pF	GJM0225C1CR40BB01#			±0.1pF	GJM0225C1C2R4BB01#			
		0.50pF	±0.05pF	GJM0225C1CR50WB01#		±0.25pF	GJM0225C1C2R4CB01#				
			±0.1pF	GJM0225C1CR50BB01#		2.5pF	±0.05pF	GJM0225C1C2R5WB01#			
		0.60pF	±0.05pF	GJM0225C1CR60WB01#			±0.1pF	GJM0225C1C2R5BB01#			
			±0.1pF	GJM0225C1CR60BB01#		±0.25pF	GJM0225C1C2R5CB01#				
		0.70pF	±0.05pF	GJM0225C1CR70WB01#		2.6pF	±0.05pF	GJM0225C1C2R6WB01#			
			±0.1pF	GJM0225C1CR70BB01#			±0.1pF	GJM0225C1C2R6BB01#			
		0.80pF	±0.05pF	GJM0225C1CR80WB01#		±0.25pF	GJM0225C1C2R6CB01#				
			±0.1pF	GJM0225C1CR80BB01#		2.7pF	±0.05pF	GJM0225C1C2R7WB01#			
		0.90pF	±0.05pF	GJM0225C1CR90WB01#			±0.1pF	GJM0225C1C2R7BB01#			
			±0.1pF	GJM0225C1CR90BB01#		±0.25pF	GJM0225C1C2R7CB01#				
		1.0pF	±0.05pF	GJM0225C1C1R0WB01#		2.8pF	±0.05pF	GJM0225C1C2R8WB01#			
			±0.1pF	GJM0225C1C1R0BB01#			±0.1pF	GJM0225C1C2R8BB01#			
			±0.25pF	GJM0225C1C1R0CB01#			±0.25pF	GJM0225C1C2R8CB01#			
		1.1pF	±0.05pF	GJM0225C1C1R1WB01#		2.9pF	±0.05pF	GJM0225C1C2R9WB01#			
			±0.1pF	GJM0225C1C1R1BB01#			±0.1pF	GJM0225C1C2R9BB01#			
			±0.25pF	GJM0225C1C1R1CB01#			±0.25pF	GJM0225C1C2R9CB01#			
		1.2pF	±0.05pF	GJM0225C1C1R2WB01#		3.0pF	±0.05pF	GJM0225C1C3R0WB01#			
			±0.1pF	GJM0225C1C1R2BB01#			±0.1pF	GJM0225C1C3R0BB01#			
			±0.25pF	GJM0225C1C1R2CB01#			±0.25pF	GJM0225C1C3R0CB01#			
		1.3pF	±0.05pF	GJM0225C1C1R3WB01#		3.1pF	±0.05pF	GJM0225C1C3R1WB01#			
			±0.1pF	GJM0225C1C1R3BB01#			±0.1pF	GJM0225C1C3R1BB01#			
			±0.25pF	GJM0225C1C1R3CB01#			±0.25pF	GJM0225C1C3R1CB01#			
		1.4pF	±0.05pF	GJM0225C1C1R4WB01#		3.2pF	±0.05pF	GJM0225C1C3R2WB01#			
			±0.1pF	GJM0225C1C1R4BB01#			±0.1pF	GJM0225C1C3R2BB01#			
			±0.25pF	GJM0225C1C1R4CB01#			±0.25pF	GJM0225C1C3R2CB01#			
		1.5pF	±0.05pF	GJM0225C1C1R5WB01#		3.3pF	±0.05pF	GJM0225C1C3R3WB01#			
			±0.1pF	GJM0225C1C1R5BB01#			±0.1pF	GJM0225C1C3R3BB01#			
			±0.25pF	GJM0225C1C1R5CB01#			±0.25pF	GJM0225C1C3R3CB01#			
		1.6pF	±0.05pF	GJM0225C1C1R6WB01#		3.4pF	±0.05pF	GJM0225C1C3R4WB01#			
			±0.1pF	GJM0225C1C1R6BB01#			±0.1pF	GJM0225C1C3R4BB01#			
			±0.25pF	GJM0225C1C1R6CB01#			±0.25pF	GJM0225C1C3R4CB01#			
		1.7pF	±0.05pF	GJM0225C1C1R7WB01#		3.5pF	±0.05pF	GJM0225C1C3R5WB01#			
			±0.1pF	GJM0225C1C1R7BB01#			±0.1pF	GJM0225C1C3R5BB01#			
			±0.25pF	GJM0225C1C1R7CB01#			±0.25pF	GJM0225C1C3R5CB01#			
		1.8pF	±0.05pF	GJM0225C1C1R8WB01#		3.6pF	±0.05pF	GJM0225C1C3R6WB01#			
			±0.1pF	GJM0225C1C1R8BB01#			±0.1pF	GJM0225C1C3R6BB01#			
			±0.25pF	GJM0225C1C1R8CB01#			±0.25pF	GJM0225C1C3R6CB01#			
		1.9pF	±0.05pF	GJM0225C1C1R9WB01#		3.7pF	±0.05pF	GJM0225C1C3R7WB01#			
			±0.1pF	GJM0225C1C1R9BB01#			±0.1pF	GJM0225C1C3R7BB01#			
			±0.25pF	GJM0225C1C1R9CB01#			±0.25pF	GJM0225C1C3R7CB01#			
		2.0pF	±0.05pF	GJM0225C1C2R0WB01#		3.8pF	±0.05pF	GJM0225C1C3R8WB01#			
			±0.1pF	GJM0225C1C2R0BB01#			±0.1pF	GJM0225C1C3R8BB01#			

- GRM
- GR3
- GRJ
- GR4
- GJM
- GQM
- GQ2
- GA2
- GA3
- GB
- GA3
- GD
- GA3
- GF
- LLL
- LLA
- LLM
- LLR
- NFM
- GJ4
- ZRA
- ZRB
- KRM
- KR3
- GMA
- GMD
- ⚠Caution /Notice

Part number # indicates the package specification code.

GJM Series Temperature Compensating Type High Q Part Number List

(→ 0.4×0.2mm)

Rated Voltage	TC Code	Cap.	Tol.	Part Number	Rated Voltage	TC Code	Cap.	Tol.	Part Number
16Vdc	COG	3.8pF	±0.25pF	GJM0225C1C3R8CB01#	16Vdc	COG	5.5pF	±0.1pF	GJM0225C1C5R5BB01#
			±0.05pF	GJM0225C1C3R9WB01#				±0.25pF	GJM0225C1C5R5CB01#
			±0.1pF	GJM0225C1C3R9BB01#				±0.5pF	GJM0225C1C5R5DB01#
		±0.25pF	GJM0225C1C3R9CB01#	5.6pF			±0.05pF	GJM0225C1C5R6WB01#	
		4.0pF	±0.05pF				GJM0225C1C4R0WB01#	±0.1pF	GJM0225C1C5R6BB01#
			±0.1pF				GJM0225C1C4R0BB01#	±0.25pF	GJM0225C1C5R6CB01#
			±0.25pF	GJM0225C1C4R0CB01#			±0.5pF	GJM0225C1C5R6DB01#	
		4.1pF	±0.05pF	GJM0225C1C4R1WB01#			5.7pF	±0.05pF	GJM0225C1C5R7WB01#
			±0.1pF	GJM0225C1C4R1BB01#				±0.1pF	GJM0225C1C5R7BB01#
			±0.25pF	GJM0225C1C4R1CB01#				±0.25pF	GJM0225C1C5R7CB01#
		4.2pF	±0.05pF	GJM0225C1C4R2WB01#			5.8pF	±0.05pF	GJM0225C1C5R8WB01#
			±0.1pF	GJM0225C1C4R2BB01#				±0.1pF	GJM0225C1C5R8BB01#
			±0.25pF	GJM0225C1C4R2CB01#				±0.25pF	GJM0225C1C5R8CB01#
		4.3pF	±0.05pF	GJM0225C1C4R3WB01#			5.9pF	±0.05pF	GJM0225C1C5R9WB01#
			±0.1pF	GJM0225C1C4R3BB01#				±0.1pF	GJM0225C1C5R9BB01#
			±0.25pF	GJM0225C1C4R3CB01#				±0.25pF	GJM0225C1C5R9CB01#
		4.4pF	±0.05pF	GJM0225C1C4R4WB01#			6.0pF	±0.05pF	GJM0225C1C6R0WB01#
			±0.1pF	GJM0225C1C4R4BB01#				±0.1pF	GJM0225C1C6R0BB01#
			±0.25pF	GJM0225C1C4R4CB01#				±0.25pF	GJM0225C1C6R0CB01#
		4.5pF	±0.05pF	GJM0225C1C4R5WB01#			6.1pF	±0.05pF	GJM0225C1C6R1WB01#
			±0.1pF	GJM0225C1C4R5BB01#				±0.1pF	GJM0225C1C6R1BB01#
			±0.25pF	GJM0225C1C4R5CB01#				±0.25pF	GJM0225C1C6R1CB01#
		4.6pF	±0.05pF	GJM0225C1C4R6WB01#			6.2pF	±0.05pF	GJM0225C1C6R2WB01#
			±0.1pF	GJM0225C1C4R6BB01#				±0.1pF	GJM0225C1C6R2BB01#
			±0.25pF	GJM0225C1C4R6CB01#				±0.25pF	GJM0225C1C6R2CB01#
		4.7pF	±0.05pF	GJM0225C1C4R7WB01#			6.3pF	±0.05pF	GJM0225C1C6R3WB01#
			±0.1pF	GJM0225C1C4R7BB01#				±0.1pF	GJM0225C1C6R3BB01#
			±0.25pF	GJM0225C1C4R7CB01#				±0.25pF	GJM0225C1C6R3CB01#
		4.8pF	±0.05pF	GJM0225C1C4R8WB01#			6.4pF	±0.05pF	GJM0225C1C6R4WB01#
			±0.1pF	GJM0225C1C4R8BB01#				±0.1pF	GJM0225C1C6R4BB01#
			±0.25pF	GJM0225C1C4R8CB01#				±0.25pF	GJM0225C1C6R4CB01#
		4.9pF	±0.05pF	GJM0225C1C4R9WB01#			6.5pF	±0.05pF	GJM0225C1C6R5WB01#
			±0.1pF	GJM0225C1C4R9BB01#				±0.1pF	GJM0225C1C6R5BB01#
			±0.25pF	GJM0225C1C4R9CB01#				±0.25pF	GJM0225C1C6R5CB01#
		5.0pF	±0.05pF	GJM0225C1C5R0WB01#			6.6pF	±0.05pF	GJM0225C1C6R6WB01#
			±0.1pF	GJM0225C1C5R0BB01#				±0.1pF	GJM0225C1C6R6BB01#
			±0.25pF	GJM0225C1C5R0CB01#				±0.25pF	GJM0225C1C6R6CB01#
		5.1pF	±0.05pF	GJM0225C1C5R1WB01#			6.7pF	±0.05pF	GJM0225C1C6R7WB01#
			±0.1pF	GJM0225C1C5R1BB01#				±0.1pF	GJM0225C1C6R7BB01#
			±0.25pF	GJM0225C1C5R1CB01#				±0.25pF	GJM0225C1C6R7CB01#
		5.2pF	±0.05pF	GJM0225C1C5R2WB01#			6.8pF	±0.05pF	GJM0225C1C6R8WB01#
			±0.1pF	GJM0225C1C5R2BB01#				±0.1pF	GJM0225C1C6R8BB01#
			±0.25pF	GJM0225C1C5R2CB01#				±0.25pF	GJM0225C1C6R8CB01#
		5.3pF	±0.05pF	GJM0225C1C5R3WB01#					
			±0.1pF	GJM0225C1C5R3BB01#					
			±0.25pF	GJM0225C1C5R3CB01#					
		5.4pF	±0.05pF	GJM0225C1C5R4WB01#					
			±0.1pF	GJM0225C1C5R4BB01#					
			±0.25pF	GJM0225C1C5R4CB01#					
		5.5pF	±0.05pF	GJM0225C1C5R5WB01#					

- GRM
- GR3
- GRJ
- GR4
- GJM
- GQM
- GQ2
- GA2
- GA3
- GA3
- GA3
- GA3
- GB
- GD
- GF
- LLL
- LLA
- LLM
- LLR
- NFM
- GJ4
- ZRA
- ZRB
- KRM
- KR3
- GMA
- GMD
- ⚠Caution / Notice

Part number # indicates the package specification code.

GJM Series Temperature Compensating Type High Q Part Number List

(→ 0.4×0.2mm)

Rated Voltage	TC Code	Cap.	Tol.	Part Number	Rated Voltage	TC Code	Cap.	Tol.	Part Number
16Vdc	COG	6.8pF	±0.5pF	GJM0225C1C6R8DB01#	16Vdc	COG	8.2pF	±0.1pF	GJM0225C1C8R2BB01#
			±0.05pF	GJM0225C1C6R9WB01#				±0.25pF	GJM0225C1C8R2CB01#
		6.9pF	±0.1pF	GJM0225C1C6R9BB01#			±0.5pF	GJM0225C1C8R2DB01#	
			±0.25pF	GJM0225C1C6R9CB01#			8.3pF	±0.05pF	GJM0225C1C8R3WB01#
			±0.5pF	GJM0225C1C6R9DB01#				±0.1pF	GJM0225C1C8R3BB01#
			7.0pF	±0.05pF			GJM0225C1C7R0WB01#	±0.25pF	GJM0225C1C8R3CB01#
		±0.1pF		GJM0225C1C7R0BB01#			±0.5pF	GJM0225C1C8R3DB01#	
		±0.25pF		GJM0225C1C7R0CB01#			8.4pF	±0.05pF	GJM0225C1C8R4WB01#
		±0.5pF		GJM0225C1C7R0DB01#				±0.1pF	GJM0225C1C8R4BB01#
		7.1pF	±0.05pF	GJM0225C1C7R1WB01#			±0.25pF	GJM0225C1C8R4CB01#	
			±0.1pF	GJM0225C1C7R1BB01#			±0.5pF	GJM0225C1C8R4DB01#	
			±0.25pF	GJM0225C1C7R1CB01#			8.5pF	±0.05pF	GJM0225C1C8R5WB01#
			±0.5pF	GJM0225C1C7R1DB01#				±0.1pF	GJM0225C1C8R5BB01#
		7.2pF	±0.05pF	GJM0225C1C7R2WB01#				±0.25pF	GJM0225C1C8R5CB01#
			±0.1pF	GJM0225C1C7R2BB01#				±0.5pF	GJM0225C1C8R5DB01#
			±0.25pF	GJM0225C1C7R2CB01#			8.6pF	±0.05pF	GJM0225C1C8R6WB01#
			±0.5pF	GJM0225C1C7R2DB01#				±0.1pF	GJM0225C1C8R6BB01#
		7.3pF	±0.05pF	GJM0225C1C7R3WB01#				±0.25pF	GJM0225C1C8R6CB01#
			±0.1pF	GJM0225C1C7R3BB01#				±0.5pF	GJM0225C1C8R6DB01#
			±0.25pF	GJM0225C1C7R3CB01#			8.7pF	±0.05pF	GJM0225C1C8R7WB01#
			±0.5pF	GJM0225C1C7R3DB01#				±0.1pF	GJM0225C1C8R7BB01#
		7.4pF	±0.05pF	GJM0225C1C7R4WB01#				±0.25pF	GJM0225C1C8R7CB01#
			±0.1pF	GJM0225C1C7R4BB01#				±0.5pF	GJM0225C1C8R7DB01#
			±0.25pF	GJM0225C1C7R4CB01#			8.8pF	±0.05pF	GJM0225C1C8R8WB01#
			±0.5pF	GJM0225C1C7R4DB01#				±0.1pF	GJM0225C1C8R8BB01#
		7.5pF	±0.05pF	GJM0225C1C7R5WB01#				±0.25pF	GJM0225C1C8R8CB01#
			±0.1pF	GJM0225C1C7R5BB01#				±0.5pF	GJM0225C1C8R8DB01#
			±0.25pF	GJM0225C1C7R5CB01#			8.9pF	±0.05pF	GJM0225C1C8R9WB01#
			±0.5pF	GJM0225C1C7R5DB01#				±0.1pF	GJM0225C1C8R9BB01#
		7.6pF	±0.05pF	GJM0225C1C7R6WB01#				±0.25pF	GJM0225C1C8R9CB01#
			±0.1pF	GJM0225C1C7R6BB01#				±0.5pF	GJM0225C1C8R9DB01#
			±0.25pF	GJM0225C1C7R6CB01#			9.0pF	±0.05pF	GJM0225C1C9R0WB01#
			±0.5pF	GJM0225C1C7R6DB01#				±0.1pF	GJM0225C1C9R0BB01#
		7.7pF	±0.05pF	GJM0225C1C7R7WB01#				±0.25pF	GJM0225C1C9R0CB01#
			±0.1pF	GJM0225C1C7R7BB01#				±0.5pF	GJM0225C1C9R0DB01#
			±0.25pF	GJM0225C1C7R7CB01#			9.1pF	±0.05pF	GJM0225C1C9R1WB01#
			±0.5pF	GJM0225C1C7R7DB01#				±0.1pF	GJM0225C1C9R1BB01#
		7.8pF	±0.05pF	GJM0225C1C7R8WB01#				±0.25pF	GJM0225C1C9R1CB01#
			±0.1pF	GJM0225C1C7R8BB01#				±0.5pF	GJM0225C1C9R1DB01#
			±0.25pF	GJM0225C1C7R8CB01#			9.2pF	±0.05pF	GJM0225C1C9R2WB01#
			±0.5pF	GJM0225C1C7R8DB01#				±0.1pF	GJM0225C1C9R2BB01#
		7.9pF	±0.05pF	GJM0225C1C7R9WB01#				±0.25pF	GJM0225C1C9R2CB01#
			±0.1pF	GJM0225C1C7R9BB01#				±0.5pF	GJM0225C1C9R2DB01#
			±0.25pF	GJM0225C1C7R9CB01#			9.3pF	±0.05pF	GJM0225C1C9R3WB01#
			±0.5pF	GJM0225C1C7R9DB01#				±0.1pF	GJM0225C1C9R3BB01#
		8.0pF	±0.05pF	GJM0225C1C8R0WB01#				±0.25pF	GJM0225C1C9R3CB01#
			±0.1pF	GJM0225C1C8R0BB01#				±0.5pF	GJM0225C1C9R3DB01#
			±0.25pF	GJM0225C1C8R0CB01#			9.4pF	±0.05pF	GJM0225C1C9R4WB01#
			±0.5pF	GJM0225C1C8R0DB01#				±0.1pF	GJM0225C1C9R4BB01#
		8.1pF	±0.05pF	GJM0225C1C8R1WB01#				±0.25pF	GJM0225C1C9R4CB01#
			±0.1pF	GJM0225C1C8R1BB01#				±0.5pF	GJM0225C1C9R4DB01#
			±0.25pF	GJM0225C1C8R1CB01#			9.5pF	±0.05pF	GJM0225C1C9R5WB01#
			±0.5pF	GJM0225C1C8R1DB01#				±0.1pF	GJM0225C1C9R5BB01#
		8.2pF	±0.05pF	GJM0225C1C8R2WB01#				±0.25pF	GJM0225C1C9R5CB01#

- GRM
- GR3
- GRJ
- GR4
- GJM
- GQM
- GQ2
- GA2
- GA3
- GA3
- GA3
- GA3
- LL
- LLA
- LLM
- LLR
- NFM
- GJ4
- ZRA
- ZRB
- KRM
- KR3
- GMA
- GMD
- △Caution / Notice

Part number # indicates the package specification code.

GJM Series Temperature Compensating Type High Q Part Number List

(→ 0.4×0.2mm)

Rated Voltage	TC Code	Cap.	Tol.	Part Number	Rated Voltage	TC Code	Cap.	Tol.	Part Number	
16Vdc	COG	9.5pF	±0.5pF	GJM0225C1C9R5DB01#	16Vdc	CH	4.6pF	±0.1pF	GJM0222C1C4R6BB01#	
			±0.05pF	GJM0225C1C9R6WB01#				±0.25pF	GJM0222C1C4R6CB01#	
		±0.1pF	GJM0225C1C9R6BB01#	4.7pF			±0.05pF	GJM0222C1C4R7WB01#		
		±0.25pF	GJM0225C1C9R6CB01#				±0.1pF	GJM0222C1C4R7BB01#		
		9.7pF	±0.05pF	GJM0225C1C9R7WB01#			4.8pF	±0.05pF	GJM0222C1C4R8WB01#	
			±0.1pF	GJM0225C1C9R7BB01#				±0.1pF	GJM0222C1C4R8BB01#	
			±0.25pF	GJM0225C1C9R7CB01#				±0.25pF	GJM0222C1C4R8CB01#	
			±0.5pF	GJM0225C1C9R7DB01#				4.9pF	±0.05pF	GJM0222C1C4R9WB01#
		9.8pF	±0.05pF	GJM0225C1C9R8WB01#			±0.1pF		GJM0222C1C4R9BB01#	
			±0.1pF	GJM0225C1C9R8BB01#			±0.25pF	GJM0222C1C4R9CB01#		
		9.9pF	±0.05pF	GJM0225C1C9R9WB01#			5.0pF	±0.05pF	GJM0222C1C5R0WB01#	
			±0.1pF	GJM0225C1C9R9BB01#				±0.1pF	GJM0222C1C5R0BB01#	
			±0.25pF	GJM0225C1C9R9CB01#				±0.25pF	GJM0222C1C5R0CB01#	
		10pF	±2%	GJM0225C1C100GB01#			5.1pF	±0.05pF	GJM0222C1C5R1WB01#	
			±5%	GJM0225C1C100JB01#				±0.1pF	GJM0222C1C5R1BB01#	
			11pF	±2%				GJM0225C1C110GB01#	±0.25pF	GJM0222C1C5R1CB01#
		±5%		GJM0225C1C110JB01#			±0.5pF	GJM0222C1C5R1DB01#		
		12pF		±2%			GJM0225C1C120GB01#	5.2pF	±0.05pF	GJM0222C1C5R2WB01#
			±5%	GJM0225C1C120JB01#			±0.1pF		GJM0222C1C5R2BB01#	
			13pF	±2%			GJM0225C1C130GB01#		±0.25pF	GJM0222C1C5R2CB01#
		±5%		GJM0225C1C130JB01#			±0.5pF	GJM0222C1C5R2DB01#		
		15pF		±2%			GJM0225C1C150GB01#	5.3pF	±0.05pF	GJM0222C1C5R3WB01#
			±5%	GJM0225C1C150JB01#			±0.1pF		GJM0222C1C5R3BB01#	
		16pF	±2%	GJM0225C1C160GB01#			±0.25pF	GJM0222C1C5R3CB01#		
			±5%	GJM0225C1C160JB01#			±0.5pF	GJM0222C1C5R3DB01#		
		18pF	±2%	GJM0225C1C180GB01#			5.4pF	±0.05pF	GJM0222C1C5R4WB01#	
			±5%	GJM0225C1C180JB01#				±0.1pF	GJM0222C1C5R4BB01#	
		20pF	±2%	GJM0225C1C200GB01#			±0.25pF	GJM0222C1C5R4CB01#		
			±5%	GJM0225C1C200JB01#			±0.5pF	GJM0222C1C5R4DB01#		
			22pF	±2%			GJM0225C1C220GB01#	5.5pF	±0.05pF	GJM0222C1C5R5WB01#
		±5%		GJM0225C1C220JB01#			±0.1pF		GJM0222C1C5R5BB01#	
		CH	4.0pF	±0.05pF			GJM0222C1C4R0WB01#	±0.25pF	GJM0222C1C5R5CB01#	
				±0.1pF			GJM0222C1C4R0BB01#	±0.5pF	GJM0222C1C5R5DB01#	
				±0.25pF			GJM0222C1C4R0CB01#	5.6pF	±0.05pF	GJM0222C1C5R6WB01#
			4.1pF	±0.05pF			GJM0222C1C4R1WB01#		±0.1pF	GJM0222C1C5R6BB01#
				±0.1pF			GJM0222C1C4R1BB01#		±0.25pF	GJM0222C1C5R6CB01#
			±0.25pF	GJM0222C1C4R1CB01#			5.7pF	±0.5pF	GJM0222C1C5R6DB01#	
			4.2pF	±0.05pF				GJM0222C1C4R2WB01#	±0.05pF	GJM0222C1C5R7WB01#
				±0.1pF				GJM0222C1C4R2BB01#	±0.1pF	GJM0222C1C5R7BB01#
			±0.25pF	GJM0222C1C4R2CB01#			±0.25pF	GJM0222C1C5R7CB01#		
			4.3pF	±0.05pF			GJM0222C1C4R3WB01#	±0.5pF	GJM0222C1C5R7DB01#	
				±0.1pF			GJM0222C1C4R3BB01#	5.8pF	±0.05pF	GJM0222C1C5R8WB01#
				±0.25pF			GJM0222C1C4R3CB01#		±0.1pF	GJM0222C1C5R8BB01#
			4.4pF	±0.05pF			GJM0222C1C4R4WB01#		±0.25pF	GJM0222C1C5R8CB01#
				±0.1pF			GJM0222C1C4R4BB01#	±0.5pF	GJM0222C1C5R8DB01#	
				±0.25pF			GJM0222C1C4R4CB01#	5.9pF	±0.05pF	GJM0222C1C5R9WB01#
			4.5pF	±0.05pF			GJM0222C1C4R5WB01#		±0.1pF	GJM0222C1C5R9BB01#
				±0.1pF			GJM0222C1C4R5BB01#		±0.25pF	GJM0222C1C5R9CB01#
	±0.25pF		GJM0222C1C4R5CB01#	±0.5pF	GJM0222C1C5R9DB01#					
	4.6pF		±0.05pF	GJM0222C1C4R6WB01#	6.0pF	±0.05pF	GJM0222C1C6R0WB01#			
			±0.1pF	GJM0222C1C4R6BB01#		±0.1pF	GJM0222C1C6R0BB01#			
			±0.25pF	GJM0222C1C4R6CB01#		±0.25pF	GJM0222C1C6R0CB01#			
±0.5pF	GJM0222C1C6R0DB01#									

Part number # indicates the package specification code.

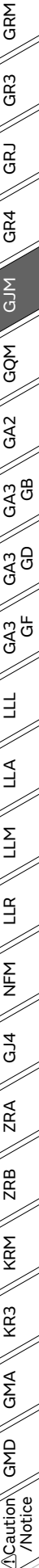

GJM Series Temperature Compensating Type High Q Part Number List

(→ 0.4×0.2mm)

Rated Voltage	TC Code	Cap.	Tol.	Part Number	Rated Voltage	TC Code	Cap.	Tol.	Part Number	
16Vdc	CH	6.1pF	±0.05pF	GJM0222C1C6R1WB01#	16Vdc	CH	7.4pF	±0.25pF	GJM0222C1C7R4CB01#	
			±0.1pF	GJM0222C1C6R1BB01#				±0.5pF	GJM0222C1C7R4DB01#	
			±0.25pF	GJM0222C1C6R1CB01#				7.5pF	±0.05pF	GJM0222C1C7R5WB01#
			±0.5pF	GJM0222C1C6R1DB01#					±0.1pF	GJM0222C1C7R5BB01#
		6.2pF	±0.05pF	GJM0222C1C6R2WB01#			±0.25pF		GJM0222C1C7R5CB01#	
			±0.1pF	GJM0222C1C6R2BB01#			±0.5pF		GJM0222C1C7R5DB01#	
			±0.25pF	GJM0222C1C6R2CB01#			7.6pF	±0.05pF	GJM0222C1C7R6WB01#	
			±0.5pF	GJM0222C1C6R2DB01#				±0.1pF	GJM0222C1C7R6BB01#	
		6.3pF	±0.05pF	GJM0222C1C6R3WB01#				±0.25pF	GJM0222C1C7R6CB01#	
			±0.1pF	GJM0222C1C6R3BB01#				±0.5pF	GJM0222C1C7R6DB01#	
			±0.25pF	GJM0222C1C6R3CB01#			7.7pF	±0.05pF	GJM0222C1C7R7WB01#	
			±0.5pF	GJM0222C1C6R3DB01#				±0.1pF	GJM0222C1C7R7BB01#	
		6.4pF	±0.05pF	GJM0222C1C6R4WB01#				±0.25pF	GJM0222C1C7R7CB01#	
			±0.1pF	GJM0222C1C6R4BB01#				±0.5pF	GJM0222C1C7R7DB01#	
			±0.25pF	GJM0222C1C6R4CB01#			7.8pF	±0.05pF	GJM0222C1C7R8WB01#	
			±0.5pF	GJM0222C1C6R4DB01#				±0.1pF	GJM0222C1C7R8BB01#	
		6.5pF	±0.05pF	GJM0222C1C6R5WB01#				±0.25pF	GJM0222C1C7R8CB01#	
			±0.1pF	GJM0222C1C6R5BB01#				±0.5pF	GJM0222C1C7R8DB01#	
			±0.25pF	GJM0222C1C6R5CB01#			7.9pF	±0.05pF	GJM0222C1C7R9WB01#	
			±0.5pF	GJM0222C1C6R5DB01#				±0.1pF	GJM0222C1C7R9BB01#	
		6.6pF	±0.05pF	GJM0222C1C6R6WB01#				±0.25pF	GJM0222C1C7R9CB01#	
			±0.1pF	GJM0222C1C6R6BB01#				±0.5pF	GJM0222C1C7R9DB01#	
			±0.25pF	GJM0222C1C6R6CB01#			8.0pF	±0.05pF	GJM0222C1C8R0WB01#	
			±0.5pF	GJM0222C1C6R6DB01#				±0.1pF	GJM0222C1C8R0BB01#	
		6.7pF	±0.05pF	GJM0222C1C6R7WB01#				±0.25pF	GJM0222C1C8R0CB01#	
			±0.1pF	GJM0222C1C6R7BB01#				±0.5pF	GJM0222C1C8R0DB01#	
			±0.25pF	GJM0222C1C6R7CB01#			8.1pF	±0.05pF	GJM0222C1C8R1WB01#	
			±0.5pF	GJM0222C1C6R7DB01#				±0.1pF	GJM0222C1C8R1BB01#	
		6.8pF	±0.05pF	GJM0222C1C6R8WB01#				±0.25pF	GJM0222C1C8R1CB01#	
			±0.1pF	GJM0222C1C6R8BB01#				±0.5pF	GJM0222C1C8R1DB01#	
			±0.25pF	GJM0222C1C6R8CB01#			8.2pF	±0.05pF	GJM0222C1C8R2WB01#	
			±0.5pF	GJM0222C1C6R8DB01#				±0.1pF	GJM0222C1C8R2BB01#	
		6.9pF	±0.05pF	GJM0222C1C6R9WB01#				±0.25pF	GJM0222C1C8R2CB01#	
			±0.1pF	GJM0222C1C6R9BB01#				±0.5pF	GJM0222C1C8R2DB01#	
			±0.25pF	GJM0222C1C6R9CB01#			8.3pF	±0.05pF	GJM0222C1C8R3WB01#	
			±0.5pF	GJM0222C1C6R9DB01#				±0.1pF	GJM0222C1C8R3BB01#	
		7.0pF	±0.05pF	GJM0222C1C7R0WB01#				±0.25pF	GJM0222C1C8R3CB01#	
			±0.1pF	GJM0222C1C7R0BB01#				±0.5pF	GJM0222C1C8R3DB01#	
			±0.25pF	GJM0222C1C7R0CB01#			8.4pF	±0.05pF	GJM0222C1C8R4WB01#	
			±0.5pF	GJM0222C1C7R0DB01#				±0.1pF	GJM0222C1C8R4BB01#	
		7.1pF	±0.05pF	GJM0222C1C7R1WB01#				±0.25pF	GJM0222C1C8R4CB01#	
			±0.1pF	GJM0222C1C7R1BB01#				±0.5pF	GJM0222C1C8R4DB01#	
			±0.25pF	GJM0222C1C7R1CB01#			8.5pF	±0.05pF	GJM0222C1C8R5WB01#	
			±0.5pF	GJM0222C1C7R1DB01#				±0.1pF	GJM0222C1C8R5BB01#	
		7.2pF	±0.05pF	GJM0222C1C7R2WB01#				±0.25pF	GJM0222C1C8R5CB01#	
			±0.1pF	GJM0222C1C7R2BB01#				±0.5pF	GJM0222C1C8R5DB01#	
			±0.25pF	GJM0222C1C7R2CB01#			8.6pF	±0.05pF	GJM0222C1C8R6WB01#	
			±0.5pF	GJM0222C1C7R2DB01#				±0.1pF	GJM0222C1C8R6BB01#	
		7.3pF	±0.05pF	GJM0222C1C7R3WB01#				±0.25pF	GJM0222C1C8R6CB01#	
			±0.1pF	GJM0222C1C7R3BB01#				±0.5pF	GJM0222C1C8R6DB01#	
			±0.25pF	GJM0222C1C7R3CB01#			8.7pF	±0.05pF	GJM0222C1C8R7WB01#	
			±0.5pF	GJM0222C1C7R3DB01#				±0.1pF	GJM0222C1C8R7BB01#	
		7.4pF	±0.05pF	GJM0222C1C7R4WB01#				±0.25pF	GJM0222C1C8R7CB01#	
			±0.1pF	GJM0222C1C7R4BB01#				±0.5pF	GJM0222C1C8R7DB01#	

- GRM
- GR3
- GRJ
- GR4
- GJM
- GQM
- GGA2
- GGA3 GB
- GGA3 GD
- GGA3 GF
- LLL
- LLA
- LLM
- LLR
- NFM
- GJ4
- ZRA
- ZRB
- KRM
- KR3
- GMA
- GMD
- ⚠Caution /Notice

Part number # indicates the package specification code.

GJM Series Temperature Compensating Type High Q Part Number List

(→ 0.4×0.2mm)

Rated Voltage	TC Code	Cap.	Tol.	Part Number	Rated Voltage	TC Code	Cap.	Tol.	Part Number		
16Vdc	CH	8.8pF	±0.05pF	GJM0222C1C8R8WB01#	16Vdc	CH	13pF	±2%	GJM0222C1C130GB01#		
			±0.1pF	GJM0222C1C8R8BB01#				±5%	GJM0222C1C130JB01#		
			±0.25pF	GJM0222C1C8R8CB01#				15pF	±2%	GJM0222C1C150GB01#	
			±0.5pF	GJM0222C1C8R8DB01#					±5%	GJM0222C1C150JB01#	
		8.9pF	±0.05pF	GJM0222C1C8R9WB01#			16pF	±2%	GJM0222C1C160GB01#		
			±0.1pF	GJM0222C1C8R9BB01#				±5%	GJM0222C1C160JB01#		
			±0.25pF	GJM0222C1C8R9CB01#			18pF	±2%	GJM0222C1C180GB01#		
			±0.5pF	GJM0222C1C8R9DB01#				±5%	GJM0222C1C180JB01#		
		9.0pF	±0.05pF	GJM0222C1C9R0WB01#			20pF	±2%	GJM0222C1C200GB01#		
			±0.1pF	GJM0222C1C9R0BB01#				±5%	GJM0222C1C200JB01#		
			±0.25pF	GJM0222C1C9R0CB01#			22pF	±2%	GJM0222C1C220GB01#		
			±0.5pF	GJM0222C1C9R0DB01#				±5%	GJM0222C1C220JB01#		
		9.1pF	±0.05pF	GJM0222C1C9R1WB01#			CJ	2.1pF	±0.05pF	GJM0223C1C2R1WB01#	
			±0.1pF	GJM0222C1C9R1BB01#					±0.1pF	GJM0223C1C2R1BB01#	
			±0.25pF	GJM0222C1C9R1CB01#					±0.25pF	GJM0223C1C2R1CB01#	
			±0.5pF	GJM0222C1C9R1DB01#				2.2pF	±0.05pF	GJM0223C1C2R2WB01#	
		9.2pF	±0.05pF	GJM0222C1C9R2WB01#					±0.1pF	GJM0223C1C2R2BB01#	
			±0.1pF	GJM0222C1C9R2BB01#					±0.25pF	GJM0223C1C2R2CB01#	
			±0.25pF	GJM0222C1C9R2CB01#				2.3pF	±0.05pF	GJM0223C1C2R3WB01#	
		±0.5pF	GJM0222C1C9R2DB01#	±0.1pF					GJM0223C1C2R3BB01#		
		9.3pF	±0.05pF	GJM0222C1C9R3WB01#					±0.25pF	GJM0223C1C2R3CB01#	
			±0.1pF	GJM0222C1C9R3BB01#				2.4pF	±0.05pF	GJM0223C1C2R4WB01#	
			±0.25pF	GJM0222C1C9R3CB01#					±0.1pF	GJM0223C1C2R4BB01#	
		±0.5pF	GJM0222C1C9R3DB01#	±0.25pF					GJM0223C1C2R4CB01#		
		9.4pF	±0.05pF	GJM0222C1C9R4WB01#				2.5pF	±0.05pF	GJM0223C1C2R5WB01#	
			±0.1pF	GJM0222C1C9R4BB01#					±0.1pF	GJM0223C1C2R5BB01#	
			±0.25pF	GJM0222C1C9R4CB01#					±0.25pF	GJM0223C1C2R5CB01#	
			±0.5pF	GJM0222C1C9R4DB01#				2.6pF	±0.05pF	GJM0223C1C2R6WB01#	
		9.5pF	±0.05pF	GJM0222C1C9R5WB01#					±0.1pF	GJM0223C1C2R6BB01#	
			±0.1pF	GJM0222C1C9R5BB01#					±0.25pF	GJM0223C1C2R6CB01#	
			±0.25pF	GJM0222C1C9R5CB01#				2.7pF	±0.05pF	GJM0223C1C2R7WB01#	
		±0.5pF	GJM0222C1C9R5DB01#	±0.1pF					GJM0223C1C2R7BB01#		
		9.6pF	±0.05pF	GJM0222C1C9R6WB01#					±0.25pF	GJM0223C1C2R7CB01#	
			±0.1pF	GJM0222C1C9R6BB01#				2.8pF	±0.05pF	GJM0223C1C2R8WB01#	
			±0.25pF	GJM0222C1C9R6CB01#					±0.1pF	GJM0223C1C2R8BB01#	
			±0.5pF	GJM0222C1C9R6DB01#					±0.25pF	GJM0223C1C2R8CB01#	
		9.7pF	±0.05pF	GJM0222C1C9R7WB01#				2.9pF	±0.05pF	GJM0223C1C2R9WB01#	
			±0.1pF	GJM0222C1C9R7BB01#					±0.1pF	GJM0223C1C2R9BB01#	
			±0.25pF	GJM0222C1C9R7CB01#					±0.25pF	GJM0223C1C2R9CB01#	
			±0.5pF	GJM0222C1C9R7DB01#				3.0pF	±0.05pF	GJM0223C1C3R0WB01#	
		9.8pF	±0.05pF	GJM0222C1C9R8WB01#					±0.1pF	GJM0223C1C3R0BB01#	
			±0.1pF	GJM0222C1C9R8BB01#					±0.25pF	GJM0223C1C3R0CB01#	
			±0.25pF	GJM0222C1C9R8CB01#				3.1pF	±0.05pF	GJM0223C1C3R1WB01#	
		±0.5pF	GJM0222C1C9R8DB01#	±0.1pF					GJM0223C1C3R1BB01#		
		9.9pF	±0.05pF	GJM0222C1C9R9WB01#					±0.25pF	GJM0223C1C3R1CB01#	
			±0.1pF	GJM0222C1C9R9BB01#				3.2pF	±0.05pF	GJM0223C1C3R2WB01#	
			±0.25pF	GJM0222C1C9R9CB01#					±0.1pF	GJM0223C1C3R2BB01#	
			±0.5pF	GJM0222C1C9R9DB01#					±0.25pF	GJM0223C1C3R2CB01#	
		10pF	±2%	GJM0222C1C100GB01#				3.3pF	±0.05pF	GJM0223C1C3R3WB01#	
			±5%	GJM0222C1C100JB01#					±0.1pF	GJM0223C1C3R3BB01#	
		11pF	±2%	GJM0222C1C110GB01#					±0.25pF	GJM0223C1C3R3CB01#	
			±5%	GJM0222C1C110JB01#					3.4pF	±0.05pF	GJM0223C1C3R4WB01#
		12pF	±2%	GJM0222C1C120GB01#						±0.1pF	GJM0223C1C3R4BB01#
			±5%	GJM0222C1C120JB01#						±0.25pF	GJM0223C1C3R4CB01#

- GRM
- GR3
- GRJ
- GR4
- GJM
- GQM
- GQ2
- GA2
- GA3 GB
- GA3 GD
- GA3 GF
- LLL
- LLA
- LLM
- LLR
- NFM
- GJ4
- ZRA
- ZRB
- KRM
- KR3
- GMA
- GMD
- ⚠Caution /Notice

Part number # indicates the package specification code.

GJM Series Temperature Compensating Type High Q Part Number List

(→ 0.4×0.2mm)

Rated Voltage	TC Code	Cap.	Tol.	Part Number		
16Vdc	CJ	3.5pF	±0.05pF	GJM0223C1C3R5WB01#		
			±0.1pF	GJM0223C1C3R5BB01#		
			±0.25pF	GJM0223C1C3R5CB01#		
		3.6pF	±0.05pF	GJM0223C1C3R6WB01#		
			±0.1pF	GJM0223C1C3R6BB01#		
			±0.25pF	GJM0223C1C3R6CB01#		
		3.7pF	±0.05pF	GJM0223C1C3R7WB01#		
			±0.1pF	GJM0223C1C3R7BB01#		
			±0.25pF	GJM0223C1C3R7CB01#		
		3.8pF	±0.05pF	GJM0223C1C3R8WB01#		
			±0.1pF	GJM0223C1C3R8BB01#		
			±0.25pF	GJM0223C1C3R8CB01#		
		3.9pF	±0.05pF	GJM0223C1C3R9WB01#		
			±0.1pF	GJM0223C1C3R9BB01#		
			±0.25pF	GJM0223C1C3R9CB01#		
		16Vdc	CK	0.20pF	±0.05pF	GJM0224C1CR20WB01#
					±0.1pF	GJM0224C1CR20BB01#
				0.30pF	±0.05pF	GJM0224C1CR30WB01#
	±0.1pF				GJM0224C1CR30BB01#	
	0.40pF			±0.05pF	GJM0224C1CR40WB01#	
				±0.1pF	GJM0224C1CR40BB01#	
	0.50pF			±0.05pF	GJM0224C1CR50WB01#	
				±0.1pF	GJM0224C1CR50BB01#	
	0.60pF			±0.05pF	GJM0224C1CR60WB01#	
				±0.1pF	GJM0224C1CR60BB01#	
	0.70pF			±0.05pF	GJM0224C1CR70WB01#	
				±0.1pF	GJM0224C1CR70BB01#	
	0.80pF			±0.05pF	GJM0224C1CR80WB01#	
				±0.1pF	GJM0224C1CR80BB01#	
	0.90pF			±0.05pF	GJM0224C1CR90WB01#	
				±0.1pF	GJM0224C1CR90BB01#	
	1.0pF			±0.05pF	GJM0224C1C1R0WB01#	
				±0.1pF	GJM0224C1C1R0BB01#	
				±0.25pF	GJM0224C1C1R0CB01#	
	1.1pF			±0.05pF	GJM0224C1C1R1WB01#	
				±0.1pF	GJM0224C1C1R1BB01#	
±0.25pF				GJM0224C1C1R1CB01#		
1.2pF	±0.05pF			GJM0224C1C1R2WB01#		
	±0.1pF			GJM0224C1C1R2BB01#		
	±0.25pF			GJM0224C1C1R2CB01#		
1.3pF	±0.05pF			GJM0224C1C1R3WB01#		
	±0.1pF			GJM0224C1C1R3BB01#		
	±0.25pF			GJM0224C1C1R3CB01#		
1.4pF	±0.05pF			GJM0224C1C1R4WB01#		
	±0.1pF			GJM0224C1C1R4BB01#		
	±0.25pF			GJM0224C1C1R4CB01#		
1.5pF	±0.05pF			GJM0224C1C1R5WB01#		
	±0.1pF			GJM0224C1C1R5BB01#		
	±0.25pF			GJM0224C1C1R5CB01#		
1.6pF	±0.05pF			GJM0224C1C1R6WB01#		
	±0.1pF			GJM0224C1C1R6BB01#		
	±0.25pF	GJM0224C1C1R6CB01#				
1.7pF	±0.05pF	GJM0224C1C1R7WB01#				
	±0.1pF	GJM0224C1C1R7BB01#				

Rated Voltage	TC Code	Cap.	Tol.	Part Number	
16Vdc	CK	1.7pF	±0.25pF	GJM0224C1C1R7CB01#	
			±0.05pF	GJM0224C1C1R8WB01#	
		1.8pF	±0.05pF	GJM0224C1C1R8WB01#	
			±0.1pF	GJM0224C1C1R8BB01#	
		1.9pF	±0.05pF	GJM0224C1C1R9WB01#	
			±0.1pF	GJM0224C1C1R9BB01#	
		2.0pF	±0.05pF	GJM0224C1C2R0WB01#	
			±0.1pF	GJM0224C1C2R0BB01#	
				±0.25pF	GJM0224C1C2R0CB01#

0.6×0.3mm

Rated Voltage	TC Code	Cap.	Tol.	Part Number
100Vdc	COG	0.30pF	±0.05pF	GJM0335C2AR30WB01#
			±0.1pF	GJM0335C2AR30BB01#
		0.40pF	±0.05pF	GJM0335C2AR40WB01#
			±0.1pF	GJM0335C2AR40BB01#
		0.50pF	±0.05pF	GJM0335C2AR50WB01#
			±0.1pF	GJM0335C2AR50BB01#
		0.60pF	±0.05pF	GJM0335C2AR60WB01#
			±0.1pF	GJM0335C2AR60BB01#
		0.70pF	±0.05pF	GJM0335C2AR70WB01#
			±0.1pF	GJM0335C2AR70BB01#
		0.80pF	±0.05pF	GJM0335C2AR80WB01#
			±0.1pF	GJM0335C2AR80BB01#
		0.90pF	±0.05pF	GJM0335C2AR90WB01#
			±0.1pF	GJM0335C2AR90BB01#
		1.0pF	±0.05pF	GJM0335C2A1R0WB01#
			±0.1pF	GJM0335C2A1R0BB01#
			±0.25pF	GJM0335C2A1R0CB01#
		1.1pF	±0.05pF	GJM0335C2A1R1WB01#
			±0.1pF	GJM0335C2A1R1BB01#
			±0.25pF	GJM0335C2A1R1CB01#
		1.2pF	±0.05pF	GJM0335C2A1R2WB01#
			±0.1pF	GJM0335C2A1R2BB01#
			±0.25pF	GJM0335C2A1R2CB01#
		1.3pF	±0.05pF	GJM0335C2A1R3WB01#
			±0.1pF	GJM0335C2A1R3BB01#
			±0.25pF	GJM0335C2A1R3CB01#
		1.4pF	±0.05pF	GJM0335C2A1R4WB01#
			±0.1pF	GJM0335C2A1R4BB01#
			±0.25pF	GJM0335C2A1R4CB01#
		1.5pF	±0.05pF	GJM0335C2A1R5WB01#
			±0.1pF	GJM0335C2A1R5BB01#
			±0.25pF	GJM0335C2A1R5CB01#
		1.6pF	±0.05pF	GJM0335C2A1R6WB01#
			±0.1pF	GJM0335C2A1R6BB01#
			±0.25pF	GJM0335C2A1R6CB01#
		1.7pF	±0.05pF	GJM0335C2A1R7WB01#
			±0.1pF	GJM0335C2A1R7BB01#
			±0.25pF	GJM0335C2A1R7CB01#
		1.8pF	±0.05pF	GJM0335C2A1R8WB01#

Part number # indicates the package specification code.

- GRM
- GR3
- GRJ
- GR4
- GJM
- GQM
- GQ2
- GA2
- GA3
- GB
- GA3
- GD
- GA3
- GF
- LLL
- LLA
- LLM
- LLR
- NFM
- GJ4
- ZRA
- ZRB
- KRM
- KR3
- GMA
- GMD
- △Caution / Notice

GJM Series Temperature Compensating Type High Q Part Number List

(→ 0.6×0.3mm)

Rated Voltage	TC Code	Cap.	Tol.	Part Number	Rated Voltage	TC Code	Cap.	Tol.	Part Number
100Vdc	COG	1.8pF	±0.1pF	GJM0335C2A1R8BB01#	100Vdc	COG	3.6pF	±0.1pF	GJM0335C2A3R6BB01#
			±0.25pF	GJM0335C2A1R8CB01#				±0.25pF	GJM0335C2A3R6CB01#
		1.9pF	±0.05pF	GJM0335C2A1R9WB01#			3.7pF	±0.05pF	GJM0335C2A3R7WB01#
			±0.1pF	GJM0335C2A1R9BB01#				±0.1pF	GJM0335C2A3R7BB01#
			±0.25pF	GJM0335C2A1R9CB01#				±0.25pF	GJM0335C2A3R7CB01#
		2.0pF	±0.05pF	GJM0335C2A2R0WB01#			3.8pF	±0.05pF	GJM0335C2A3R8WB01#
			±0.1pF	GJM0335C2A2R0BB01#				±0.1pF	GJM0335C2A3R8BB01#
			±0.25pF	GJM0335C2A2R0CB01#				±0.25pF	GJM0335C2A3R8CB01#
		2.1pF	±0.05pF	GJM0335C2A2R1WB01#			3.9pF	±0.05pF	GJM0335C2A3R9WB01#
			±0.1pF	GJM0335C2A2R1BB01#				±0.1pF	GJM0335C2A3R9BB01#
			±0.25pF	GJM0335C2A2R1CB01#				±0.25pF	GJM0335C2A3R9CB01#
		2.2pF	±0.05pF	GJM0335C2A2R2WB01#			4.0pF	±0.05pF	GJM0335C2A4R0WB01#
			±0.1pF	GJM0335C2A2R2BB01#				±0.1pF	GJM0335C2A4R0BB01#
			±0.25pF	GJM0335C2A2R2CB01#				±0.25pF	GJM0335C2A4R0CB01#
		2.3pF	±0.05pF	GJM0335C2A2R3WB01#			4.1pF	±0.05pF	GJM0335C2A4R1WB01#
			±0.1pF	GJM0335C2A2R3BB01#				±0.1pF	GJM0335C2A4R1BB01#
			±0.25pF	GJM0335C2A2R3CB01#				±0.25pF	GJM0335C2A4R1CB01#
		2.4pF	±0.05pF	GJM0335C2A2R4WB01#			4.2pF	±0.05pF	GJM0335C2A4R2WB01#
			±0.1pF	GJM0335C2A2R4BB01#				±0.1pF	GJM0335C2A4R2BB01#
			±0.25pF	GJM0335C2A2R4CB01#				±0.25pF	GJM0335C2A4R2CB01#
		2.5pF	±0.05pF	GJM0335C2A2R5WB01#			4.3pF	±0.05pF	GJM0335C2A4R3WB01#
			±0.1pF	GJM0335C2A2R5BB01#				±0.1pF	GJM0335C2A4R3BB01#
			±0.25pF	GJM0335C2A2R5CB01#				±0.25pF	GJM0335C2A4R3CB01#
		2.6pF	±0.05pF	GJM0335C2A2R6WB01#			4.4pF	±0.05pF	GJM0335C2A4R4WB01#
			±0.1pF	GJM0335C2A2R6BB01#				±0.1pF	GJM0335C2A4R4BB01#
			±0.25pF	GJM0335C2A2R6CB01#				±0.25pF	GJM0335C2A4R4CB01#
		2.7pF	±0.05pF	GJM0335C2A2R7WB01#			4.5pF	±0.05pF	GJM0335C2A4R5WB01#
			±0.1pF	GJM0335C2A2R7BB01#				±0.1pF	GJM0335C2A4R5BB01#
			±0.25pF	GJM0335C2A2R7CB01#				±0.25pF	GJM0335C2A4R5CB01#
		2.8pF	±0.05pF	GJM0335C2A2R8WB01#			4.6pF	±0.05pF	GJM0335C2A4R6WB01#
			±0.1pF	GJM0335C2A2R8BB01#				±0.1pF	GJM0335C2A4R6BB01#
			±0.25pF	GJM0335C2A2R8CB01#				±0.25pF	GJM0335C2A4R6CB01#
		2.9pF	±0.05pF	GJM0335C2A2R9WB01#			4.7pF	±0.05pF	GJM0335C2A4R7WB01#
			±0.1pF	GJM0335C2A2R9BB01#				±0.1pF	GJM0335C2A4R7BB01#
			±0.25pF	GJM0335C2A2R9CB01#				±0.25pF	GJM0335C2A4R7CB01#
		3.0pF	±0.05pF	GJM0335C2A3R0WB01#			4.8pF	±0.05pF	GJM0335C2A4R8WB01#
			±0.1pF	GJM0335C2A3R0BB01#				±0.1pF	GJM0335C2A4R8BB01#
			±0.25pF	GJM0335C2A3R0CB01#				±0.25pF	GJM0335C2A4R8CB01#
		3.1pF	±0.05pF	GJM0335C2A3R1WB01#			4.9pF	±0.05pF	GJM0335C2A4R9WB01#
			±0.1pF	GJM0335C2A3R1BB01#				±0.1pF	GJM0335C2A4R9BB01#
			±0.25pF	GJM0335C2A3R1CB01#				±0.25pF	GJM0335C2A4R9CB01#
		3.2pF	±0.05pF	GJM0335C2A3R2WB01#			5.0pF	±0.05pF	GJM0335C2A5R0WB01#
			±0.1pF	GJM0335C2A3R2BB01#				±0.1pF	GJM0335C2A5R0BB01#
			±0.25pF	GJM0335C2A3R2CB01#				±0.25pF	GJM0335C2A5R0CB01#
		3.3pF	±0.05pF	GJM0335C2A3R3WB01#			5.1pF	±0.05pF	GJM0335C2A5R1WB01#
			±0.1pF	GJM0335C2A3R3BB01#				±0.1pF	GJM0335C2A5R1BB01#
			±0.25pF	GJM0335C2A3R3CB01#				±0.25pF	GJM0335C2A5R1CB01#
		3.4pF	±0.05pF	GJM0335C2A3R4WB01#			5.2pF	±0.05pF	GJM0335C2A5R2WB01#
±0.1pF	GJM0335C2A3R4BB01#		±0.1pF	GJM0335C2A5R2BB01#					
±0.25pF	GJM0335C2A3R4CB01#		±0.25pF	GJM0335C2A5R2CB01#					
3.5pF	±0.05pF	GJM0335C2A3R5WB01#	5.3pF	±0.05pF	GJM0335C2A5R3WB01#				
	±0.1pF	GJM0335C2A3R5BB01#		±0.1pF	GJM0335C2A5R3BB01#				
	±0.25pF	GJM0335C2A3R5CB01#		±0.25pF	GJM0335C2A5R3CB01#				

Part number # indicates the package specification code.

GRM
 GR3
 GRJ
 GR4
 GJM
 GQM
 GA2
 GA3 GB
 GA3 GD
 GA3 GF
 LLL
 LLA
 LLM
 LLR
 NFM
 GJ4
 ZRA
 ZRB
 KRM
 KR3
 GMA
 GMD
 ⚠Caution /Notice

GJM Series Temperature Compensating Type High Q Part Number List

(→ 0.6×0.3mm)

Rated Voltage	TC Code	Cap.	Tol.	Part Number	Rated Voltage	TC Code	Cap.	Tol.	Part Number
100Vdc	COG	5.3pF	±0.25pF	GJM0335C2A5R3CB01#	100Vdc	COG	6.7pF	±0.05pF	GJM0335C2A6R7WB01#
			±0.5pF	GJM0335C2A5R3DB01#				±0.1pF	GJM0335C2A6R7BB01#
		5.4pF	±0.05pF	GJM0335C2A5R4WB01#			±0.25pF	GJM0335C2A6R7CB01#	
			±0.1pF	GJM0335C2A5R4BB01#			±0.5pF	GJM0335C2A6R7DB01#	
			±0.25pF	GJM0335C2A5R4CB01#			6.8pF	±0.05pF	GJM0335C2A6R8WB01#
			±0.5pF	GJM0335C2A5R4DB01#				±0.1pF	GJM0335C2A6R8BB01#
		5.5pF	±0.05pF	GJM0335C2A5R5WB01#				±0.25pF	GJM0335C2A6R8CB01#
			±0.1pF	GJM0335C2A5R5BB01#			±0.5pF	GJM0335C2A6R8DB01#	
			±0.25pF	GJM0335C2A5R5CB01#			6.9pF	±0.05pF	GJM0335C2A6R9WB01#
		±0.5pF	GJM0335C2A5R5DB01#	±0.1pF				GJM0335C2A6R9BB01#	
		5.6pF	±0.05pF	GJM0335C2A5R6WB01#				±0.25pF	GJM0335C2A6R9CB01#
			±0.1pF	GJM0335C2A5R6BB01#			±0.5pF	GJM0335C2A6R9DB01#	
			±0.25pF	GJM0335C2A5R6CB01#			7.0pF	±0.05pF	GJM0335C2A7R0WB01#
			±0.5pF	GJM0335C2A5R6DB01#				±0.1pF	GJM0335C2A7R0BB01#
		5.7pF	±0.05pF	GJM0335C2A5R7WB01#				±0.25pF	GJM0335C2A7R0CB01#
			±0.1pF	GJM0335C2A5R7BB01#			±0.5pF	GJM0335C2A7R0DB01#	
			±0.25pF	GJM0335C2A5R7CB01#			7.1pF	±0.05pF	GJM0335C2A7R1WB01#
		±0.5pF	GJM0335C2A5R7DB01#	±0.1pF				GJM0335C2A7R1BB01#	
		5.8pF	±0.05pF	GJM0335C2A5R8WB01#				±0.25pF	GJM0335C2A7R1CB01#
			±0.1pF	GJM0335C2A5R8BB01#			±0.5pF	GJM0335C2A7R1DB01#	
			±0.25pF	GJM0335C2A5R8CB01#			7.2pF	±0.05pF	GJM0335C2A7R2WB01#
			±0.5pF	GJM0335C2A5R8DB01#				±0.1pF	GJM0335C2A7R2BB01#
		5.9pF	±0.05pF	GJM0335C2A5R9WB01#				±0.25pF	GJM0335C2A7R2CB01#
			±0.1pF	GJM0335C2A5R9BB01#			±0.5pF	GJM0335C2A7R2DB01#	
			±0.25pF	GJM0335C2A5R9CB01#			7.3pF	±0.05pF	GJM0335C2A7R3WB01#
		±0.5pF	GJM0335C2A5R9DB01#	±0.1pF				GJM0335C2A7R3BB01#	
		6.0pF	±0.05pF	GJM0335C2A6R0WB01#				±0.25pF	GJM0335C2A7R3CB01#
			±0.1pF	GJM0335C2A6R0BB01#			±0.5pF	GJM0335C2A7R3DB01#	
			±0.25pF	GJM0335C2A6R0CB01#			7.4pF	±0.05pF	GJM0335C2A7R4WB01#
			±0.5pF	GJM0335C2A6R0DB01#				±0.1pF	GJM0335C2A7R4BB01#
		6.1pF	±0.05pF	GJM0335C2A6R1WB01#				±0.25pF	GJM0335C2A7R4CB01#
			±0.1pF	GJM0335C2A6R1BB01#			±0.5pF	GJM0335C2A7R4DB01#	
			±0.25pF	GJM0335C2A6R1CB01#			7.5pF	±0.05pF	GJM0335C2A7R5WB01#
			±0.5pF	GJM0335C2A6R1DB01#				±0.1pF	GJM0335C2A7R5BB01#
		6.2pF	±0.05pF	GJM0335C2A6R2WB01#				±0.25pF	GJM0335C2A7R5CB01#
			±0.1pF	GJM0335C2A6R2BB01#			±0.5pF	GJM0335C2A7R5DB01#	
			±0.25pF	GJM0335C2A6R2CB01#			7.6pF	±0.05pF	GJM0335C2A7R6WB01#
			±0.5pF	GJM0335C2A6R2DB01#				±0.1pF	GJM0335C2A7R6BB01#
		6.3pF	±0.05pF	GJM0335C2A6R3WB01#				±0.25pF	GJM0335C2A7R6CB01#
			±0.1pF	GJM0335C2A6R3BB01#			±0.5pF	GJM0335C2A7R6DB01#	
			±0.25pF	GJM0335C2A6R3CB01#			7.7pF	±0.05pF	GJM0335C2A7R7WB01#
			±0.5pF	GJM0335C2A6R3DB01#				±0.1pF	GJM0335C2A7R7BB01#
		6.4pF	±0.05pF	GJM0335C2A6R4WB01#				±0.25pF	GJM0335C2A7R7CB01#
			±0.1pF	GJM0335C2A6R4BB01#			±0.5pF	GJM0335C2A7R7DB01#	
			±0.25pF	GJM0335C2A6R4CB01#			7.8pF	±0.05pF	GJM0335C2A7R8WB01#
			±0.5pF	GJM0335C2A6R4DB01#				±0.1pF	GJM0335C2A7R8BB01#
		6.5pF	±0.05pF	GJM0335C2A6R5WB01#				±0.25pF	GJM0335C2A7R8CB01#
			±0.1pF	GJM0335C2A6R5BB01#			±0.5pF	GJM0335C2A7R8DB01#	
±0.25pF	GJM0335C2A6R5CB01#		7.9pF	±0.05pF	GJM0335C2A7R9WB01#				
±0.5pF	GJM0335C2A6R5DB01#			±0.1pF	GJM0335C2A7R9BB01#				
6.6pF	±0.05pF	GJM0335C2A6R6WB01#		±0.25pF	GJM0335C2A7R9CB01#				
	±0.1pF	GJM0335C2A6R6BB01#	±0.5pF	GJM0335C2A7R9DB01#					
	±0.25pF	GJM0335C2A6R6CB01#	8.0pF	±0.05pF	GJM0335C2A8R0WB01#				
	±0.5pF	GJM0335C2A6R6DB01#		±0.1pF	GJM0335C2A8R0BB01#				

Part number # indicates the package specification code.

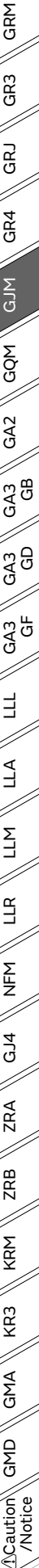

GJM Series Temperature Compensating Type High Q Part Number List

(→ 0.6×0.3mm)

Rated Voltage	TC Code	Cap.	Tol.	Part Number	Rated Voltage	TC Code	Cap.	Tol.	Part Number	
100Vdc	COG	8.0pF	±0.25pF	GJM0335C2A8R0CB01#	100Vdc	COG	9.4pF	±0.05pF	GJM0335C2A9R4WB01#	
			±0.5pF	GJM0335C2A8R0DB01#				±0.1pF	GJM0335C2A9R4BB01#	
		8.1pF	±0.05pF	GJM0335C2A8R1WB01#			±0.25pF	GJM0335C2A9R4CB01#		
			±0.1pF	GJM0335C2A8R1BB01#			±0.5pF	GJM0335C2A9R4DB01#		
			±0.25pF	GJM0335C2A8R1CB01#			9.5pF	±0.05pF	GJM0335C2A9R5WB01#	
			±0.5pF	GJM0335C2A8R1DB01#				±0.1pF	GJM0335C2A9R5BB01#	
		8.2pF	±0.05pF	GJM0335C2A8R2WB01#			±0.25pF	GJM0335C2A9R5CB01#		
			±0.1pF	GJM0335C2A8R2BB01#			±0.5pF	GJM0335C2A9R5DB01#		
			±0.25pF	GJM0335C2A8R2CB01#			9.6pF	±0.05pF	GJM0335C2A9R6WB01#	
			±0.5pF	GJM0335C2A8R2DB01#				±0.1pF	GJM0335C2A9R6BB01#	
		8.3pF	±0.05pF	GJM0335C2A8R3WB01#			±0.25pF	GJM0335C2A9R6CB01#		
			±0.1pF	GJM0335C2A8R3BB01#			±0.5pF	GJM0335C2A9R6DB01#		
			±0.25pF	GJM0335C2A8R3CB01#			9.7pF	±0.05pF	GJM0335C2A9R7WB01#	
			±0.5pF	GJM0335C2A8R3DB01#				±0.1pF	GJM0335C2A9R7BB01#	
		8.4pF	±0.05pF	GJM0335C2A8R4WB01#				±0.25pF	GJM0335C2A9R7CB01#	
			±0.1pF	GJM0335C2A8R4BB01#			±0.5pF	GJM0335C2A9R7DB01#		
			±0.25pF	GJM0335C2A8R4CB01#			9.8pF	±0.05pF	GJM0335C2A9R8WB01#	
			±0.5pF	GJM0335C2A8R4DB01#				±0.1pF	GJM0335C2A9R8BB01#	
		8.5pF	±0.05pF	GJM0335C2A8R5WB01#			±0.25pF	GJM0335C2A9R8CB01#		
			±0.1pF	GJM0335C2A8R5BB01#			±0.5pF	GJM0335C2A9R8DB01#		
			±0.25pF	GJM0335C2A8R5CB01#			9.9pF	±0.05pF	GJM0335C2A9R9WB01#	
			±0.5pF	GJM0335C2A8R5DB01#				±0.1pF	GJM0335C2A9R9BB01#	
		8.6pF	±0.05pF	GJM0335C2A8R6WB01#				±0.25pF	GJM0335C2A9R9CB01#	
			±0.1pF	GJM0335C2A8R6BB01#			±0.5pF	GJM0335C2A9R9DB01#		
			±0.25pF	GJM0335C2A8R6CB01#			10pF	±2%	GJM0335C2A100GB01#	
			±0.5pF	GJM0335C2A8R6DB01#				±5%	GJM0335C2A100JB01#	
		8.7pF	±0.05pF	GJM0335C2A8R7WB01#			11pF	±2%	GJM0335C2A110GB01#	
			±0.1pF	GJM0335C2A8R7BB01#				±5%	GJM0335C2A110JB01#	
			±0.25pF	GJM0335C2A8R7CB01#			12pF	±2%	GJM0335C2A120GB01#	
			±0.5pF	GJM0335C2A8R7DB01#				±5%	GJM0335C2A120JB01#	
		8.8pF	±0.05pF	GJM0335C2A8R8WB01#			13pF	±2%	GJM0335C2A130GB01#	
			±0.1pF	GJM0335C2A8R8BB01#				±5%	GJM0335C2A130JB01#	
			±0.25pF	GJM0335C2A8R8CB01#			15pF	±2%	GJM0335C2A150GB01#	
			±0.5pF	GJM0335C2A8R8DB01#				±5%	GJM0335C2A150JB01#	
		8.9pF	±0.05pF	GJM0335C2A8R9WB01#			CH	4.0pF	±0.05pF	GJM0332C2A4R0WB01#
			±0.1pF	GJM0335C2A8R9BB01#					±0.1pF	GJM0332C2A4R0BB01#
			±0.25pF	GJM0335C2A8R9CB01#					±0.25pF	GJM0332C2A4R0CB01#
			±0.5pF	GJM0335C2A8R9DB01#				4.1pF	±0.05pF	GJM0332C2A4R1WB01#
		9.0pF	±0.05pF	GJM0335C2A9R0WB01#					±0.1pF	GJM0332C2A4R1BB01#
			±0.1pF	GJM0335C2A9R0BB01#					±0.25pF	GJM0332C2A4R1CB01#
			±0.25pF	GJM0335C2A9R0CB01#				4.2pF	±0.05pF	GJM0332C2A4R2WB01#
			±0.5pF	GJM0335C2A9R0DB01#					±0.1pF	GJM0332C2A4R2BB01#
		9.1pF	±0.05pF	GJM0335C2A9R1WB01#				±0.25pF	GJM0332C2A4R2CB01#	
			±0.1pF	GJM0335C2A9R1BB01#				4.3pF	±0.05pF	GJM0332C2A4R3WB01#
			±0.25pF	GJM0335C2A9R1CB01#					±0.1pF	GJM0332C2A4R3BB01#
			±0.5pF	GJM0335C2A9R1DB01#					±0.25pF	GJM0332C2A4R3CB01#
		9.2pF	±0.05pF	GJM0335C2A9R2WB01#				4.4pF	±0.05pF	GJM0332C2A4R4WB01#
			±0.1pF	GJM0335C2A9R2BB01#					±0.1pF	GJM0332C2A4R4BB01#
			±0.25pF	GJM0335C2A9R2CB01#				±0.25pF	GJM0332C2A4R4CB01#	
			±0.5pF	GJM0335C2A9R2DB01#				4.5pF	±0.05pF	GJM0332C2A4R5WB01#
		9.3pF	±0.05pF	GJM0335C2A9R3WB01#					±0.1pF	GJM0332C2A4R5BB01#
			±0.1pF	GJM0335C2A9R3BB01#				±0.25pF	GJM0332C2A4R5CB01#	
			±0.25pF	GJM0335C2A9R3CB01#				4.6pF	±0.05pF	GJM0332C2A4R6WB01#
			±0.5pF	GJM0335C2A9R3DB01#					±0.1pF	GJM0332C2A4R6BB01#

Part number # indicates the package specification code.

GJM Series Temperature Compensating Type High Q Part Number List

(→ 0.6×0.3mm)

Rated Voltage	TC Code	Cap.	Tol.	Part Number	Rated Voltage	TC Code	Cap.	Tol.	Part Number	
100Vdc	CH	4.6pF	±0.25pF	GJM0332C2A4R6CB01#	100Vdc	CH	6.1pF	±0.1pF	GJM0332C2A6R1BB01#	
			±0.05pF	GJM0332C2A4R7WB01#				±0.25pF	GJM0332C2A6R1CB01#	
			±0.1pF	GJM0332C2A4R7BB01#				±0.5pF	GJM0332C2A6R1DB01#	
		±0.25pF	GJM0332C2A4R7CB01#	6.2pF			±0.05pF	GJM0332C2A6R2WB01#		
		±0.05pF	GJM0332C2A4R8WB01#				±0.1pF	GJM0332C2A6R2BB01#		
		±0.1pF	GJM0332C2A4R8BB01#				±0.25pF	GJM0332C2A6R2CB01#		
		4.8pF	±0.25pF	GJM0332C2A4R8CB01#			±0.5pF	GJM0332C2A6R2DB01#		
			4.9pF	±0.05pF			GJM0332C2A4R9WB01#	6.3pF	±0.05pF	GJM0332C2A6R3WB01#
				±0.1pF			GJM0332C2A4R9BB01#		±0.1pF	GJM0332C2A6R3BB01#
		±0.25pF		GJM0332C2A4R9CB01#			±0.25pF		GJM0332C2A6R3CB01#	
		5.0pF	±0.05pF	GJM0332C2A5R0WB01#			±0.5pF	GJM0332C2A6R3DB01#		
			±0.1pF	GJM0332C2A5R0BB01#			6.4pF	±0.05pF	GJM0332C2A6R4WB01#	
			±0.25pF	GJM0332C2A5R0CB01#				±0.1pF	GJM0332C2A6R4BB01#	
		5.1pF	±0.05pF	GJM0332C2A5R1WB01#				±0.25pF	GJM0332C2A6R4CB01#	
			±0.1pF	GJM0332C2A5R1BB01#			±0.5pF	GJM0332C2A6R4DB01#		
			±0.25pF	GJM0332C2A5R1CB01#			6.5pF	±0.05pF	GJM0332C2A6R5WB01#	
		±0.5pF	GJM0332C2A5R1DB01#	±0.1pF				GJM0332C2A6R5BB01#		
		5.2pF	±0.05pF	GJM0332C2A5R2WB01#				±0.25pF	GJM0332C2A6R5CB01#	
			±0.1pF	GJM0332C2A5R2BB01#			±0.5pF	GJM0332C2A6R5DB01#		
			±0.25pF	GJM0332C2A5R2CB01#			6.6pF	±0.05pF	GJM0332C2A6R6WB01#	
		±0.5pF	GJM0332C2A5R2DB01#	±0.1pF				GJM0332C2A6R6BB01#		
		5.3pF	±0.05pF	GJM0332C2A5R3WB01#				±0.25pF	GJM0332C2A6R6CB01#	
			±0.1pF	GJM0332C2A5R3BB01#			±0.5pF	GJM0332C2A6R6DB01#		
			±0.25pF	GJM0332C2A5R3CB01#			6.7pF	±0.05pF	GJM0332C2A6R7WB01#	
		±0.5pF	GJM0332C2A5R3DB01#	±0.1pF				GJM0332C2A6R7BB01#		
		5.4pF	±0.05pF	GJM0332C2A5R4WB01#				±0.25pF	GJM0332C2A6R7CB01#	
			±0.1pF	GJM0332C2A5R4BB01#			±0.5pF	GJM0332C2A6R7DB01#		
			±0.25pF	GJM0332C2A5R4CB01#			6.8pF	±0.05pF	GJM0332C2A6R8WB01#	
		±0.5pF	GJM0332C2A5R4DB01#	±0.1pF				GJM0332C2A6R8BB01#		
		5.5pF	±0.05pF	GJM0332C2A5R5WB01#				±0.25pF	GJM0332C2A6R8CB01#	
			±0.1pF	GJM0332C2A5R5BB01#			±0.5pF	GJM0332C2A6R8DB01#		
			±0.25pF	GJM0332C2A5R5CB01#			6.9pF	±0.05pF	GJM0332C2A6R9WB01#	
		±0.5pF	GJM0332C2A5R5DB01#	±0.1pF				GJM0332C2A6R9BB01#		
		5.6pF	±0.05pF	GJM0332C2A5R6WB01#				±0.25pF	GJM0332C2A6R9CB01#	
			±0.1pF	GJM0332C2A5R6BB01#			±0.5pF	GJM0332C2A6R9DB01#		
			±0.25pF	GJM0332C2A5R6CB01#			7.0pF	±0.05pF	GJM0332C2A7R0WB01#	
		±0.5pF	GJM0332C2A5R6DB01#	±0.1pF				GJM0332C2A7R0BB01#		
		5.7pF	±0.05pF	GJM0332C2A5R7WB01#				±0.25pF	GJM0332C2A7R0CB01#	
			±0.1pF	GJM0332C2A5R7BB01#			±0.5pF	GJM0332C2A7R0DB01#		
			±0.25pF	GJM0332C2A5R7CB01#			7.1pF	±0.05pF	GJM0332C2A7R1WB01#	
		±0.5pF	GJM0332C2A5R7DB01#	±0.1pF				GJM0332C2A7R1BB01#		
		5.8pF	±0.05pF	GJM0332C2A5R8WB01#				±0.25pF	GJM0332C2A7R1CB01#	
			±0.1pF	GJM0332C2A5R8BB01#			±0.5pF	GJM0332C2A7R1DB01#		
			±0.25pF	GJM0332C2A5R8CB01#			7.2pF	±0.05pF	GJM0332C2A7R2WB01#	
		±0.5pF	GJM0332C2A5R8DB01#	±0.1pF				GJM0332C2A7R2BB01#		
		5.9pF	±0.05pF	GJM0332C2A5R9WB01#				±0.25pF	GJM0332C2A7R2CB01#	
			±0.1pF	GJM0332C2A5R9BB01#			±0.5pF	GJM0332C2A7R2DB01#		
			±0.25pF	GJM0332C2A5R9CB01#			7.3pF	±0.05pF	GJM0332C2A7R3WB01#	
		±0.5pF	GJM0332C2A5R9DB01#	±0.1pF				GJM0332C2A7R3BB01#		
		6.0pF	±0.05pF	GJM0332C2A6R0WB01#				±0.25pF	GJM0332C2A7R3CB01#	
			±0.1pF	GJM0332C2A6R0BB01#			±0.5pF	GJM0332C2A7R3DB01#		
			±0.25pF	GJM0332C2A6R0CB01#			7.4pF	±0.05pF	GJM0332C2A7R4WB01#	
		±0.5pF	GJM0332C2A6R0DB01#	±0.1pF				GJM0332C2A7R4BB01#		
		±0.05pF	GJM0332C2A6R1WB01#	±0.25pF				GJM0332C2A7R4CB01#		

Part number # indicates the package specification code.

- GRM
- GR3
- GRJ
- GR4
- GJM
- GQM
- GQZ
- GA2
- GA3 GB
- GA3 GD
- GA3 GF
- LLL
- LLA
- LLM
- LLR
- NFM
- GJ4
- ZRA
- ZRB
- KRM
- KR3
- GMA
- GMD
- ⚠Caution /Notice

GJM Series Temperature Compensating Type High Q Part Number List

(→ 0.6×0.3mm)

Rated Voltage	TC Code	Cap.	Tol.	Part Number	Rated Voltage	TC Code	Cap.	Tol.	Part Number
100Vdc	CH	7.4pF	±0.5pF	GJM0332C2A7R4DB01#	100Vdc	CH	8.8pF	±0.1pF	GJM0332C2A8R8BB01#
			±0.05pF	GJM0332C2A7R5WB01#				±0.25pF	GJM0332C2A8R8CB01#
		7.5pF	±0.1pF	GJM0332C2A7R5BB01#			±0.5pF	GJM0332C2A8R8DB01#	
			±0.25pF	GJM0332C2A7R5CB01#			8.9pF	±0.05pF	GJM0332C2A8R9WB01#
			±0.5pF	GJM0332C2A7R5DB01#				±0.1pF	GJM0332C2A8R9BB01#
			7.6pF	±0.05pF			GJM0332C2A7R6WB01#	±0.25pF	GJM0332C2A8R9CB01#
		±0.1pF		GJM0332C2A7R6BB01#			±0.5pF	GJM0332C2A8R9DB01#	
		±0.25pF		GJM0332C2A7R6CB01#			9.0pF	±0.05pF	GJM0332C2A9R0WB01#
		±0.5pF		GJM0332C2A7R6DB01#				±0.1pF	GJM0332C2A9R0BB01#
		7.7pF	±0.05pF	GJM0332C2A7R7WB01#			±0.25pF	GJM0332C2A9R0CB01#	
			±0.1pF	GJM0332C2A7R7BB01#			±0.5pF	GJM0332C2A9R0DB01#	
			±0.25pF	GJM0332C2A7R7CB01#			9.1pF	±0.05pF	GJM0332C2A9R1WB01#
			±0.5pF	GJM0332C2A7R7DB01#				±0.1pF	GJM0332C2A9R1BB01#
		7.8pF	±0.05pF	GJM0332C2A7R8WB01#			±0.25pF	GJM0332C2A9R1CB01#	
			±0.1pF	GJM0332C2A7R8BB01#			±0.5pF	GJM0332C2A9R1DB01#	
			±0.25pF	GJM0332C2A7R8CB01#			9.2pF	±0.05pF	GJM0332C2A9R2WB01#
			±0.5pF	GJM0332C2A7R8DB01#				±0.1pF	GJM0332C2A9R2BB01#
		7.9pF	±0.05pF	GJM0332C2A7R9WB01#			±0.25pF	GJM0332C2A9R2CB01#	
			±0.1pF	GJM0332C2A7R9BB01#			±0.5pF	GJM0332C2A9R2DB01#	
			±0.25pF	GJM0332C2A7R9CB01#			9.3pF	±0.05pF	GJM0332C2A9R3WB01#
			±0.5pF	GJM0332C2A7R9DB01#				±0.1pF	GJM0332C2A9R3BB01#
		8.0pF	±0.05pF	GJM0332C2A8R0WB01#			±0.25pF	GJM0332C2A9R3CB01#	
			±0.1pF	GJM0332C2A8R0BB01#			±0.5pF	GJM0332C2A9R3DB01#	
			±0.25pF	GJM0332C2A8R0CB01#			9.4pF	±0.05pF	GJM0332C2A9R4WB01#
			±0.5pF	GJM0332C2A8R0DB01#				±0.1pF	GJM0332C2A9R4BB01#
		8.1pF	±0.05pF	GJM0332C2A8R1WB01#			±0.25pF	GJM0332C2A9R4CB01#	
			±0.1pF	GJM0332C2A8R1BB01#			±0.5pF	GJM0332C2A9R4DB01#	
			±0.25pF	GJM0332C2A8R1CB01#			9.5pF	±0.05pF	GJM0332C2A9R5WB01#
			±0.5pF	GJM0332C2A8R1DB01#				±0.1pF	GJM0332C2A9R5BB01#
		8.2pF	±0.05pF	GJM0332C2A8R2WB01#			±0.25pF	GJM0332C2A9R5CB01#	
			±0.1pF	GJM0332C2A8R2BB01#			±0.5pF	GJM0332C2A9R5DB01#	
			±0.25pF	GJM0332C2A8R2CB01#			9.6pF	±0.05pF	GJM0332C2A9R6WB01#
			±0.5pF	GJM0332C2A8R2DB01#				±0.1pF	GJM0332C2A9R6BB01#
		8.3pF	±0.05pF	GJM0332C2A8R3WB01#			±0.25pF	GJM0332C2A9R6CB01#	
			±0.1pF	GJM0332C2A8R3BB01#			±0.5pF	GJM0332C2A9R6DB01#	
			±0.25pF	GJM0332C2A8R3CB01#			9.7pF	±0.05pF	GJM0332C2A9R7WB01#
			±0.5pF	GJM0332C2A8R3DB01#				±0.1pF	GJM0332C2A9R7BB01#
		8.4pF	±0.05pF	GJM0332C2A8R4WB01#			±0.25pF	GJM0332C2A9R7CB01#	
			±0.1pF	GJM0332C2A8R4BB01#			±0.5pF	GJM0332C2A9R7DB01#	
			±0.25pF	GJM0332C2A8R4CB01#			9.8pF	±0.05pF	GJM0332C2A9R8WB01#
			±0.5pF	GJM0332C2A8R4DB01#				±0.1pF	GJM0332C2A9R8BB01#
		8.5pF	±0.05pF	GJM0332C2A8R5WB01#			±0.25pF	GJM0332C2A9R8CB01#	
			±0.1pF	GJM0332C2A8R5BB01#			±0.5pF	GJM0332C2A9R8DB01#	
			±0.25pF	GJM0332C2A8R5CB01#			9.9pF	±0.05pF	GJM0332C2A9R9WB01#
			±0.5pF	GJM0332C2A8R5DB01#				±0.1pF	GJM0332C2A9R9BB01#
		8.6pF	±0.05pF	GJM0332C2A8R6WB01#			±0.25pF	GJM0332C2A9R9CB01#	
			±0.1pF	GJM0332C2A8R6BB01#			±0.5pF	GJM0332C2A9R9DB01#	
			±0.25pF	GJM0332C2A8R6CB01#			10pF	±2%	GJM0332C2A100GB01#
			±0.5pF	GJM0332C2A8R6DB01#				±5%	GJM0332C2A100JB01#
		8.7pF	±0.05pF	GJM0332C2A8R7WB01#			11pF	±2%	GJM0332C2A110GB01#
			±0.1pF	GJM0332C2A8R7BB01#				±5%	GJM0332C2A110JB01#
			±0.25pF	GJM0332C2A8R7CB01#			12pF	±2%	GJM0332C2A120GB01#
			±0.5pF	GJM0332C2A8R7DB01#				±5%	GJM0332C2A120JB01#
		8.8pF	±0.05pF	GJM0332C2A8R8WB01#			13pF	±2%	GJM0332C2A130GB01#

Part number # indicates the package specification code.

- GRM
- GR3
- GRJ
- GR4
- GJM
- GQM
- GGA2
- GGA3 GB
- GGA3 GD
- GGA3 GF
- LLL
- LLA
- LLM
- LLR
- NFM
- GJ4
- ZRA
- ZRB
- KRM
- KR3
- GMA
- GMD
- △Caution /Notice

GJM Series Temperature Compensating Type High Q Part Number List

(→ 0.6×0.3mm)

Rated Voltage	TC Code	Cap.	Tol.	Part Number	Rated Voltage	TC Code	Cap.	Tol.	Part Number
100Vdc	CH	13pF	±5%	GJM0332C2A130JB01#	100Vdc	CJ	3.8pF	±0.05pF	GJM0333C2A3R8WB01#
		15pF	±2%	GJM0332C2A150GB01#				±0.1pF	GJM0333C2A3R8BB01#
			±5%	GJM0332C2A150JB01#				±0.25pF	GJM0333C2A3R8CB01#
	CJ	2.1pF	±0.05pF	GJM0333C2A2R1WB01#		3.9pF	±0.05pF	GJM0333C2A3R9WB01#	
			±0.1pF	GJM0333C2A2R1BB01#			±0.1pF	GJM0333C2A3R9BB01#	
			±0.25pF	GJM0333C2A2R1CB01#			±0.25pF	GJM0333C2A3R9CB01#	
	2.2pF	±0.05pF	GJM0333C2A2R2WB01#	CK		0.30pF	±0.05pF	GJM0334C2AR30WB01#	
		±0.1pF	GJM0333C2A2R2BB01#				±0.1pF	GJM0334C2AR30BB01#	
		±0.25pF	GJM0333C2A2R2CB01#				0.40pF	±0.05pF	GJM0334C2AR40WB01#
	2.3pF	±0.05pF	GJM0333C2A2R3WB01#			±0.1pF	GJM0334C2AR40BB01#		
		±0.1pF	GJM0333C2A2R3BB01#	0.50pF		±0.05pF	GJM0334C2AR50WB01#		
		±0.25pF	GJM0333C2A2R3CB01#	±0.1pF		GJM0334C2AR50BB01#			
	2.4pF	±0.05pF	GJM0333C2A2R4WB01#	0.60pF		±0.05pF	GJM0334C2AR60WB01#		
		±0.1pF	GJM0333C2A2R4BB01#	±0.1pF		GJM0334C2AR60BB01#			
		±0.25pF	GJM0333C2A2R4CB01#	0.70pF		±0.05pF	GJM0334C2AR70WB01#		
	2.5pF	±0.05pF	GJM0333C2A2R5WB01#			±0.1pF	GJM0334C2AR70BB01#		
		±0.1pF	GJM0333C2A2R5BB01#	0.80pF		±0.05pF	GJM0334C2AR80WB01#		
		±0.25pF	GJM0333C2A2R5CB01#	±0.1pF		GJM0334C2AR80BB01#			
	2.6pF	±0.05pF	GJM0333C2A2R6WB01#	0.90pF		±0.05pF	GJM0334C2AR90WB01#		
		±0.1pF	GJM0333C2A2R6BB01#	±0.1pF		GJM0334C2AR90BB01#			
		±0.25pF	GJM0333C2A2R6CB01#	1.0pF		±0.05pF	GJM0334C2A1R0WB01#		
	2.7pF	±0.05pF	GJM0333C2A2R7WB01#			±0.1pF	GJM0334C2A1R0BB01#		
		±0.1pF	GJM0333C2A2R7BB01#	1.1pF		±0.05pF	GJM0334C2A1R1WB01#		
		±0.25pF	GJM0333C2A2R7CB01#	±0.1pF		GJM0334C2A1R1BB01#			
	2.8pF	±0.05pF	GJM0333C2A2R8WB01#			±0.25pF	GJM0334C2A1R1CB01#		
		±0.1pF	GJM0333C2A2R8BB01#	1.2pF		±0.05pF	GJM0334C2A1R2WB01#		
		±0.25pF	GJM0333C2A2R8CB01#	±0.1pF		GJM0334C2A1R2BB01#			
	2.9pF	±0.05pF	GJM0333C2A2R9WB01#			±0.25pF	GJM0334C2A1R2CB01#		
		±0.1pF	GJM0333C2A2R9BB01#	1.3pF		±0.05pF	GJM0334C2A1R3WB01#		
		±0.25pF	GJM0333C2A2R9CB01#	±0.1pF		GJM0334C2A1R3BB01#			
	3.0pF	±0.05pF	GJM0333C2A3R0WB01#			±0.25pF	GJM0334C2A1R3CB01#		
		±0.1pF	GJM0333C2A3R0BB01#	1.4pF		±0.05pF	GJM0334C2A1R4WB01#		
		±0.25pF	GJM0333C2A3R0CB01#	±0.1pF		GJM0334C2A1R4BB01#			
	3.1pF	±0.05pF	GJM0333C2A3R1WB01#			±0.25pF	GJM0334C2A1R4CB01#		
		±0.1pF	GJM0333C2A3R1BB01#	1.5pF		±0.05pF	GJM0334C2A1R5WB01#		
		±0.25pF	GJM0333C2A3R1CB01#	±0.1pF		GJM0334C2A1R5BB01#			
	3.2pF	±0.05pF	GJM0333C2A3R2WB01#			±0.25pF	GJM0334C2A1R5CB01#		
		±0.1pF	GJM0333C2A3R2BB01#	1.6pF		±0.05pF	GJM0334C2A1R6WB01#		
		±0.25pF	GJM0333C2A3R2CB01#	±0.1pF		GJM0334C2A1R6BB01#			
	3.3pF	±0.05pF	GJM0333C2A3R3WB01#			±0.25pF	GJM0334C2A1R6CB01#		
		±0.1pF	GJM0333C2A3R3BB01#	1.7pF		±0.05pF	GJM0334C2A1R7WB01#		
		±0.25pF	GJM0333C2A3R3CB01#	±0.1pF		GJM0334C2A1R7BB01#			
	3.4pF	±0.05pF	GJM0333C2A3R4WB01#			±0.25pF	GJM0334C2A1R7CB01#		
		±0.1pF	GJM0333C2A3R4BB01#	1.8pF		±0.05pF	GJM0334C2A1R8WB01#		
		±0.25pF	GJM0333C2A3R4CB01#	±0.1pF		GJM0334C2A1R8BB01#			
	3.5pF	±0.05pF	GJM0333C2A3R5WB01#			±0.25pF	GJM0334C2A1R8CB01#		
		±0.1pF	GJM0333C2A3R5BB01#	1.9pF		±0.05pF	GJM0334C2A1R9WB01#		
		±0.25pF	GJM0333C2A3R5CB01#	±0.1pF		GJM0334C2A1R9BB01#			
	3.6pF	±0.05pF	GJM0333C2A3R6WB01#			±0.25pF	GJM0334C2A1R9CB01#		
		±0.1pF	GJM0333C2A3R6BB01#	2.0pF		±0.05pF	GJM0334C2A2R0WB01#		
		±0.25pF	GJM0333C2A3R6CB01#	±0.1pF		GJM0334C2A2R0BB01#			
	3.7pF	±0.05pF	GJM0333C2A3R7WB01#			±0.25pF	GJM0334C2A2R0CB01#		
		±0.1pF	GJM0333C2A3R7BB01#	X8G		0.30pF	±0.05pF	GJM0335G2AR30WB01#	
		±0.25pF	GJM0333C2A3R7CB01#						

Part number # indicates the package specification code.

- GRM
- GR3
- GRJ
- GR4
- GJM
- GQM
- GQ2
- GA2
- GA3
- GA3
- GA3
- GA3
- LL3
- LLA
- LLM
- LLR
- NFM
- GJ4
- ZRA
- ZRB
- KRM
- KR3
- GMA
- GMD
- ⚠Caution /Notice

GJM Series Temperature Compensating Type High Q Part Number List

(→ 0.6×0.3mm)

Rated Voltage	TC Code	Cap.	Tol.	Part Number	Rated Voltage	TC Code	Cap.	Tol.	Part Number				
100Vdc	X8G	0.30pF	±0.1pF	GJM0335G2AR30BB01#	100Vdc	X8G	2.3pF	±0.25pF	GJM0335G2A2R3CB01#				
			±0.05pF	GJM0335G2AR40WB01#				2.4pF	±0.05pF	GJM0335G2A2R4WB01#			
		±0.1pF	GJM0335G2AR40BB01#	±0.1pF			GJM0335G2A2R4BB01#		2.5pF	±0.25pF	GJM0335G2A2R4CB01#		
		0.50pF	±0.05pF	GJM0335G2AR50WB01#			±0.05pF	GJM0335G2A2R5WB01#		2.6pF	±0.1pF	GJM0335G2A2R5BB01#	
			±0.1pF	GJM0335G2AR50BB01#			±0.25pF	GJM0335G2A2R5CB01#	2.7pF		±0.05pF	GJM0335G2A2R6WB01#	
		0.60pF	±0.05pF	GJM0335G2AR60WB01#			±0.1pF	GJM0335G2AR70WB01#		±0.1pF	GJM0335G2A2R6BB01#	2.8pF	±0.25pF
			±0.1pF	GJM0335G2AR60BB01#			±0.05pF	GJM0335G2AR70BB01#	±0.25pF	GJM0335G2A2R7WB01#	2.9pF		±0.05pF
		0.70pF	±0.05pF	GJM0335G2AR70WB01#			±0.1pF	GJM0335G2AR80WB01#	±0.1pF	GJM0335G2A2R7CB01#		3.0pF	±0.05pF
			±0.1pF	GJM0335G2AR80BB01#			±0.05pF	GJM0335G2AR90WB01#	±0.1pF	GJM0335G2A2R8BB01#	3.1pF		±0.25pF
		0.80pF	±0.05pF	GJM0335G2AR80WB01#			±0.1pF	GJM0335G2AR90BB01#	±0.25pF	GJM0335G2A2R9WB01#		3.2pF	±0.05pF
			±0.1pF	GJM0335G2AR90BB01#			±0.05pF	GJM0335G2A1R0WB01#	±0.1pF	GJM0335G2A2R9BB01#	3.3pF		±0.25pF
		1.0pF	±0.05pF	GJM0335G2A1R0WB01#			±0.1pF	GJM0335G2A1R0BB01#	±0.25pF	GJM0335G2A3R0WB01#		3.4pF	±0.05pF
			±0.1pF	GJM0335G2A1R0BB01#			±0.05pF	GJM0335G2A1R1WB01#	±0.1pF	GJM0335G2A3R0BB01#	3.5pF		±0.1pF
			±0.25pF	GJM0335G2A1R0CB01#			±0.1pF	GJM0335G2A1R1BB01#	±0.25pF	GJM0335G2A3R0CB01#		3.6pF	±0.25pF
		1.1pF	±0.05pF	GJM0335G2A1R1WB01#			±0.1pF	GJM0335G2A1R1BB01#	±0.05pF	GJM0335G2A1R3WB01#	3.7pF		±0.05pF
			±0.1pF	GJM0335G2A1R1BB01#			±0.05pF	GJM0335G2A1R2WB01#	±0.1pF	GJM0335G2A3R1BB01#		3.8pF	±0.1pF
			±0.25pF	GJM0335G2A1R1CB01#			±0.1pF	GJM0335G2A1R2BB01#	±0.25pF	GJM0335G2A3R1CB01#	3.9pF		±0.25pF
		1.2pF	±0.05pF	GJM0335G2A1R2WB01#			±0.1pF	GJM0335G2A1R2BB01#	±0.05pF	GJM0335G2A1R4WB01#		4.0pF	±0.05pF
			±0.1pF	GJM0335G2A1R2BB01#			±0.05pF	GJM0335G2A1R3WB01#	±0.1pF	GJM0335G2A1R4BB01#	4.1pF		±0.1pF
			±0.25pF	GJM0335G2A1R2CB01#			±0.05pF	GJM0335G2A1R3BB01#	±0.1pF	GJM0335G2A1R4CB01#		4.2pF	±0.25pF
		1.3pF	±0.05pF	GJM0335G2A1R3WB01#			±0.1pF	GJM0335G2A1R3BB01#	±0.05pF	GJM0335G2A1R5WB01#	4.3pF		±0.05pF
			±0.1pF	GJM0335G2A1R3BB01#			±0.05pF	GJM0335G2A1R4WB01#	±0.1pF	GJM0335G2A1R5BB01#		4.4pF	±0.1pF
			±0.25pF	GJM0335G2A1R3CB01#			±0.05pF	GJM0335G2A1R4WB01#	±0.25pF	GJM0335G2A1R5CB01#	4.5pF		±0.25pF
		1.4pF	±0.05pF	GJM0335G2A1R4WB01#			±0.1pF	GJM0335G2A1R4BB01#	±0.05pF	GJM0335G2A1R6WB01#		4.6pF	±0.05pF
			±0.1pF	GJM0335G2A1R4BB01#			±0.05pF	GJM0335G2A1R5WB01#	±0.1pF	GJM0335G2A1R6BB01#	4.7pF		±0.1pF
			±0.25pF	GJM0335G2A1R4CB01#			±0.05pF	GJM0335G2A1R5WB01#	±0.1pF	GJM0335G2A1R6CB01#		4.8pF	±0.25pF
		1.5pF	±0.05pF	GJM0335G2A1R5WB01#			±0.1pF	GJM0335G2A1R5BB01#	±0.05pF	GJM0335G2A1R7WB01#	4.9pF		±0.05pF
			±0.1pF	GJM0335G2A1R5BB01#			±0.05pF	GJM0335G2A1R6WB01#	±0.1pF	GJM0335G2A1R7BB01#		5.0pF	±0.1pF
			±0.25pF	GJM0335G2A1R5CB01#			±0.05pF	GJM0335G2A1R6WB01#	±0.25pF	GJM0335G2A1R7CB01#	5.1pF		±0.25pF
		1.6pF	±0.05pF	GJM0335G2A1R6WB01#			±0.1pF	GJM0335G2A1R6BB01#	±0.05pF	GJM0335G2A1R8WB01#		5.2pF	±0.05pF
			±0.1pF	GJM0335G2A1R6BB01#			±0.05pF	GJM0335G2A1R7WB01#	±0.1pF	GJM0335G2A1R8BB01#	5.3pF		±0.1pF
			±0.25pF	GJM0335G2A1R6CB01#			±0.05pF	GJM0335G2A1R7WB01#	±0.25pF	GJM0335G2A1R8CB01#		5.4pF	±0.25pF
		1.7pF	±0.05pF	GJM0335G2A1R7WB01#			±0.1pF	GJM0335G2A1R7BB01#	±0.05pF	GJM0335G2A1R9WB01#	5.5pF		±0.05pF
			±0.1pF	GJM0335G2A1R7BB01#			±0.05pF	GJM0335G2A1R8WB01#	±0.1pF	GJM0335G2A1R9BB01#		5.6pF	±0.1pF
			±0.25pF	GJM0335G2A1R7CB01#			±0.05pF	GJM0335G2A1R8WB01#	±0.25pF	GJM0335G2A1R9CB01#	5.7pF		±0.25pF
		1.8pF	±0.05pF	GJM0335G2A1R8WB01#			±0.1pF	GJM0335G2A1R8BB01#	±0.05pF	GJM0335G2A2R0WB01#		5.8pF	±0.05pF
			±0.1pF	GJM0335G2A1R8BB01#			±0.05pF	GJM0335G2A1R9WB01#	±0.1pF	GJM0335G2A2R0BB01#	5.9pF		±0.1pF
			±0.25pF	GJM0335G2A1R8CB01#			±0.05pF	GJM0335G2A1R9WB01#	±0.25pF	GJM0335G2A2R0CB01#		6.0pF	±0.25pF
		1.9pF	±0.05pF	GJM0335G2A1R9WB01#			±0.1pF	GJM0335G2A1R9BB01#	±0.05pF	GJM0335G2A2R1WB01#	6.1pF		±0.05pF
			±0.1pF	GJM0335G2A1R9BB01#			±0.05pF	GJM0335G2A2R1WB01#	±0.1pF	GJM0335G2A2R1BB01#		6.2pF	±0.1pF
			±0.25pF	GJM0335G2A1R9CB01#			±0.05pF	GJM0335G2A2R1WB01#	±0.25pF	GJM0335G2A2R1CB01#	6.3pF		±0.25pF
		2.0pF	±0.05pF	GJM0335G2A2R0WB01#			±0.1pF	GJM0335G2A2R0BB01#	±0.05pF	GJM0335G2A2R2WB01#		6.4pF	±0.05pF
±0.1pF	GJM0335G2A2R0BB01#		±0.05pF	GJM0335G2A2R2WB01#	±0.1pF	GJM0335G2A2R2BB01#	6.5pF	±0.1pF	GJM0335G2A4R8WB01#				
±0.25pF	GJM0335G2A2R0CB01#		±0.05pF	GJM0335G2A2R2WB01#	±0.25pF	GJM0335G2A2R2CB01#		6.6pF	±0.25pF	GJM0335G2A4R8BB01#			
2.1pF	±0.05pF	GJM0335G2A2R1WB01#	±0.1pF	GJM0335G2A2R1BB01#	±0.05pF	GJM0335G2A2R3WB01#	6.7pF		±0.05pF	GJM0335G2A4R8CB01#			
	±0.1pF	GJM0335G2A2R1BB01#	±0.05pF	GJM0335G2A2R3WB01#	±0.1pF	GJM0335G2A2R3BB01#		6.8pF	±0.1pF	GJM0335G2A4R9WB01#			
	±0.25pF	GJM0335G2A2R1CB01#	±0.05pF	GJM0335G2A2R3WB01#	±0.25pF	GJM0335G2A2R3CB01#	6.9pF		±0.25pF	GJM0335G2A4R9BB01#			
2.2pF	±0.05pF	GJM0335G2A2R2WB01#	±0.1pF	GJM0335G2A2R2BB01#	±0.05pF	GJM0335G2A2R4WB01#		7.0pF	±0.05pF	GJM0335G2A4R9CB01#			
	±0.1pF	GJM0335G2A2R2BB01#	±0.05pF	GJM0335G2A2R4WB01#	±0.1pF	GJM0335G2A2R4BB01#	7.1pF		±0.1pF	GJM0335G2A5R0WB01#			
	±0.25pF	GJM0335G2A2R2CB01#	±0.05pF	GJM0335G2A2R4WB01#	±0.25pF	GJM0335G2A2R4CB01#		7.2pF	±0.25pF	GJM0335G2A5R0BB01#			
2.3pF	±0.05pF	GJM0335G2A2R3WB01#	±0.1pF	GJM0335G2A2R3BB01#	±0.05pF	GJM0335G2A2R5WB01#	7.3pF		±0.05pF	GJM0335G2A5R0CB01#			
	±0.1pF	GJM0335G2A2R3BB01#	±0.05pF	GJM0335G2A2R5WB01#	±0.1pF	GJM0335G2A2R5BB01#		7.4pF	±0.1pF	GJM0335G2A5R1WB01#			
					±0.25pF	GJM0335G2A2R5CB01#	7.5pF		±0.25pF	GJM0335G2A5R1BB01#			

Part number # indicates the package specification code.

GRM
 GR3
 GRJ
 GR4
 GJM
 GQM
 GA2
 GA3 GB
 GA3 GD
 GA3 GF
 LLL
 LLA
 LLM
 LLR
 NFM
 GJ4
 ZRA
 ZRB
 KRM
 KR3
 GMA
 GMD
 △Caution /Notice

GJM Series Temperature Compensating Type High Q Part Number List

(→ 0.6×0.3mm)

Rated Voltage	TC Code	Cap.	Tol.	Part Number	Rated Voltage	TC Code	Cap.	Tol.	Part Number			
100Vdc	X8G	4.1pF	±0.25pF	GJM0335G2A4R1CB01#	100Vdc	X8G	5.7pF	±0.25pF	GJM0335G2A5R7CB01#			
			±0.05pF	GJM0335G2A4R2WB01#				±0.5pF	GJM0335G2A5R7DB01#			
			±0.1pF	GJM0335G2A4R2BB01#				5.8pF	±0.05pF	GJM0335G2A5R8WB01#		
		±0.25pF	GJM0335G2A4R2CB01#	±0.1pF			GJM0335G2A5R8BB01#					
		4.3pF	±0.05pF	GJM0335G2A4R3WB01#			±0.25pF		GJM0335G2A5R8CB01#			
			±0.1pF	GJM0335G2A4R3BB01#			±0.5pF	GJM0335G2A5R8DB01#				
			±0.25pF	GJM0335G2A4R3CB01#			5.9pF	±0.05pF	GJM0335G2A5R9WB01#			
		4.4pF	±0.05pF	GJM0335G2A4R4WB01#				±0.1pF	GJM0335G2A5R9BB01#			
			±0.1pF	GJM0335G2A4R4BB01#				±0.25pF	GJM0335G2A5R9CB01#			
			±0.25pF	GJM0335G2A4R4CB01#			±0.5pF	GJM0335G2A5R9DB01#				
		4.5pF	±0.05pF	GJM0335G2A4R5WB01#			6.0pF	±0.05pF	GJM0335G2A6R0WB01#			
			±0.1pF	GJM0335G2A4R5BB01#				±0.1pF	GJM0335G2A6R0BB01#			
			±0.25pF	GJM0335G2A4R5CB01#				±0.25pF	GJM0335G2A6R0CB01#			
		4.6pF	±0.05pF	GJM0335G2A4R6WB01#			±0.5pF	GJM0335G2A6R0DB01#	6.1pF	±0.05pF	GJM0335G2A6R1WB01#	
			±0.1pF	GJM0335G2A4R6BB01#			±0.1pF	GJM0335G2A6R1BB01#		±0.1pF	GJM0335G2A6R1CB01#	
			±0.25pF	GJM0335G2A4R6CB01#			±0.25pF	GJM0335G2A6R1CB01#		±0.5pF	GJM0335G2A6R1DB01#	
		4.7pF	±0.05pF	GJM0335G2A4R7WB01#			4.8pF	±0.05pF	GJM0335G2A4R8WB01#	6.2pF	±0.05pF	GJM0335G2A6R2WB01#
			±0.1pF	GJM0335G2A4R7BB01#				±0.1pF	GJM0335G2A4R8BB01#		±0.1pF	GJM0335G2A6R2BB01#
			±0.25pF	GJM0335G2A4R7CB01#				±0.25pF	GJM0335G2A4R8CB01#		±0.25pF	GJM0335G2A6R2CB01#
		4.8pF	±0.05pF	GJM0335G2A4R8WB01#			±0.5pF	GJM0335G2A4R8DB01#	6.3pF	±0.05pF	GJM0335G2A6R3WB01#	
			±0.1pF	GJM0335G2A4R8BB01#			±0.1pF	GJM0335G2A4R9WB01#		±0.1pF	GJM0335G2A6R3BB01#	
			±0.25pF	GJM0335G2A4R9CB01#			±0.25pF	GJM0335G2A4R9CB01#		±0.25pF	GJM0335G2A6R3CB01#	
		4.9pF	±0.05pF	GJM0335G2A4R9WB01#			±0.5pF	GJM0335G2A4R9DB01#	6.4pF	±0.05pF	GJM0335G2A6R4WB01#	
			±0.1pF	GJM0335G2A4R9BB01#			±0.1pF	GJM0335G2A5R0WB01#		±0.1pF	GJM0335G2A6R4BB01#	
			±0.25pF	GJM0335G2A5R0CB01#			±0.25pF	GJM0335G2A5R0CB01#		±0.25pF	GJM0335G2A6R4CB01#	
		5.0pF	±0.05pF	GJM0335G2A5R1WB01#			5.1pF	±0.05pF	GJM0335G2A5R1WB01#	6.5pF	±0.05pF	GJM0335G2A6R5WB01#
			±0.1pF	GJM0335G2A5R1BB01#				±0.1pF	GJM0335G2A5R1BB01#		±0.1pF	GJM0335G2A6R5BB01#
			±0.25pF	GJM0335G2A5R1CB01#				±0.25pF	GJM0335G2A5R1CB01#		±0.25pF	GJM0335G2A6R5CB01#
		5.2pF	±0.05pF	GJM0335G2A5R2WB01#			±0.5pF	GJM0335G2A5R1DB01#	6.6pF	±0.05pF	GJM0335G2A6R6WB01#	
			±0.1pF	GJM0335G2A5R2BB01#			±0.05pF	GJM0335G2A5R2WB01#		±0.1pF	GJM0335G2A6R6BB01#	
			±0.25pF	GJM0335G2A5R2CB01#			±0.1pF	GJM0335G2A5R2BB01#		±0.25pF	GJM0335G2A6R6CB01#	
		5.3pF	±0.05pF	GJM0335G2A5R3WB01#			±0.5pF	GJM0335G2A5R2DB01#	6.7pF	±0.05pF	GJM0335G2A6R7WB01#	
			±0.1pF	GJM0335G2A5R3BB01#			±0.05pF	GJM0335G2A5R3WB01#		±0.1pF	GJM0335G2A6R7BB01#	
			±0.25pF	GJM0335G2A5R3CB01#			±0.1pF	GJM0335G2A5R3BB01#		±0.25pF	GJM0335G2A6R7CB01#	
		5.4pF	±0.05pF	GJM0335G2A5R4WB01#			±0.5pF	GJM0335G2A5R3DB01#	6.8pF	±0.05pF	GJM0335G2A6R8WB01#	
			±0.1pF	GJM0335G2A5R4BB01#			±0.05pF	GJM0335G2A5R4WB01#		±0.1pF	GJM0335G2A6R8BB01#	
			±0.25pF	GJM0335G2A5R4CB01#			±0.1pF	GJM0335G2A5R4BB01#		±0.25pF	GJM0335G2A6R8CB01#	
		5.5pF	±0.05pF	GJM0335G2A5R5WB01#			±0.5pF	GJM0335G2A5R4DB01#	6.9pF	±0.05pF	GJM0335G2A6R9WB01#	
			±0.1pF	GJM0335G2A5R5BB01#			±0.05pF	GJM0335G2A5R5WB01#		±0.1pF	GJM0335G2A6R9BB01#	
			±0.25pF	GJM0335G2A5R5CB01#			±0.1pF	GJM0335G2A5R5BB01#		±0.25pF	GJM0335G2A6R9CB01#	
		5.6pF	±0.05pF	GJM0335G2A5R6WB01#			±0.5pF	GJM0335G2A5R5DB01#	7.0pF	±0.05pF	GJM0335G2A7R0WB01#	
			±0.1pF	GJM0335G2A5R6BB01#			±0.05pF	GJM0335G2A5R6WB01#		±0.1pF	GJM0335G2A7R0BB01#	
			±0.25pF	GJM0335G2A5R6CB01#			±0.1pF	GJM0335G2A5R6BB01#		±0.25pF	GJM0335G2A7R0CB01#	
		5.7pF	±0.05pF	GJM0335G2A5R7WB01#			±0.5pF	GJM0335G2A5R6DB01#		±0.05pF	GJM0335G2A7R0WB01#	
			±0.1pF	GJM0335G2A5R7BB01#			±0.1pF	GJM0335G2A5R7WB01#		±0.1pF	GJM0335G2A7R0BB01#	
							±0.25pF	GJM0335G2A5R7CB01#		±0.25pF	GJM0335G2A7R0CB01#	
											±0.5pF	GJM0335G2A7R0DB01#

Part number # indicates the package specification code.

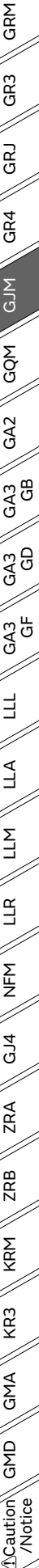

GJM Series Temperature Compensating Type High Q Part Number List

(→ 0.6×0.3mm)

Rated Voltage	TC Code	Cap.	Tol.	Part Number	Rated Voltage	TC Code	Cap.	Tol.	Part Number	
100Vdc	X8G	7.1pF	±0.05pF	GJM0335G2A7R1WB01#	100Vdc	X8G	8.4pF	±0.25pF	GJM0335G2A8R4CB01#	
			±0.1pF	GJM0335G2A7R1BB01#				±0.5pF	GJM0335G2A8R4DB01#	
			±0.25pF	GJM0335G2A7R1CB01#				8.5pF	±0.05pF	GJM0335G2A8R5WB01#
			±0.5pF	GJM0335G2A7R1DB01#					±0.1pF	GJM0335G2A8R5BB01#
		7.2pF	±0.05pF	GJM0335G2A7R2WB01#			±0.25pF		GJM0335G2A8R5CB01#	
			±0.1pF	GJM0335G2A7R2BB01#			±0.5pF		GJM0335G2A8R5DB01#	
			±0.25pF	GJM0335G2A7R2CB01#			8.6pF	±0.05pF	GJM0335G2A8R6WB01#	
			±0.5pF	GJM0335G2A7R2DB01#				±0.1pF	GJM0335G2A8R6BB01#	
		7.3pF	±0.05pF	GJM0335G2A7R3WB01#				±0.25pF	GJM0335G2A8R6CB01#	
			±0.1pF	GJM0335G2A7R3BB01#				±0.5pF	GJM0335G2A8R6DB01#	
			±0.25pF	GJM0335G2A7R3CB01#			8.7pF	±0.05pF	GJM0335G2A8R7WB01#	
			±0.5pF	GJM0335G2A7R3DB01#				±0.1pF	GJM0335G2A8R7BB01#	
		7.4pF	±0.05pF	GJM0335G2A7R4WB01#				±0.25pF	GJM0335G2A8R7CB01#	
			±0.1pF	GJM0335G2A7R4BB01#				±0.5pF	GJM0335G2A8R7DB01#	
			±0.25pF	GJM0335G2A7R4CB01#			8.8pF	±0.05pF	GJM0335G2A8R8WB01#	
			±0.5pF	GJM0335G2A7R4DB01#				±0.1pF	GJM0335G2A8R8BB01#	
		7.5pF	±0.05pF	GJM0335G2A7R5WB01#				±0.25pF	GJM0335G2A8R8CB01#	
			±0.1pF	GJM0335G2A7R5BB01#				±0.5pF	GJM0335G2A8R8DB01#	
			±0.25pF	GJM0335G2A7R5CB01#			8.9pF	±0.05pF	GJM0335G2A8R9WB01#	
			±0.5pF	GJM0335G2A7R5DB01#				±0.1pF	GJM0335G2A8R9BB01#	
		7.6pF	±0.05pF	GJM0335G2A7R6WB01#				±0.25pF	GJM0335G2A8R9CB01#	
			±0.1pF	GJM0335G2A7R6BB01#				±0.5pF	GJM0335G2A8R9DB01#	
			±0.25pF	GJM0335G2A7R6CB01#			9.0pF	±0.05pF	GJM0335G2A9R0WB01#	
			±0.5pF	GJM0335G2A7R6DB01#				±0.1pF	GJM0335G2A9R0BB01#	
		7.7pF	±0.05pF	GJM0335G2A7R7WB01#				±0.25pF	GJM0335G2A9R0CB01#	
			±0.1pF	GJM0335G2A7R7BB01#				±0.5pF	GJM0335G2A9R0DB01#	
			±0.25pF	GJM0335G2A7R7CB01#			9.1pF	±0.05pF	GJM0335G2A9R1WB01#	
			±0.5pF	GJM0335G2A7R7DB01#				±0.1pF	GJM0335G2A9R1BB01#	
		7.8pF	±0.05pF	GJM0335G2A7R8WB01#				±0.25pF	GJM0335G2A9R1CB01#	
			±0.1pF	GJM0335G2A7R8BB01#				±0.5pF	GJM0335G2A9R1DB01#	
			±0.25pF	GJM0335G2A7R8CB01#			9.2pF	±0.05pF	GJM0335G2A9R2WB01#	
			±0.5pF	GJM0335G2A7R8DB01#				±0.1pF	GJM0335G2A9R2BB01#	
		7.9pF	±0.05pF	GJM0335G2A7R9WB01#				±0.25pF	GJM0335G2A9R2CB01#	
			±0.1pF	GJM0335G2A7R9BB01#				±0.5pF	GJM0335G2A9R2DB01#	
			±0.25pF	GJM0335G2A7R9CB01#			9.3pF	±0.05pF	GJM0335G2A9R3WB01#	
			±0.5pF	GJM0335G2A7R9DB01#				±0.1pF	GJM0335G2A9R3BB01#	
		8.0pF	±0.05pF	GJM0335G2A8R0WB01#				±0.25pF	GJM0335G2A9R3CB01#	
			±0.1pF	GJM0335G2A8R0BB01#				±0.5pF	GJM0335G2A9R3DB01#	
			±0.25pF	GJM0335G2A8R0CB01#			9.4pF	±0.05pF	GJM0335G2A9R4WB01#	
			±0.5pF	GJM0335G2A8R0DB01#				±0.1pF	GJM0335G2A9R4BB01#	
		8.1pF	±0.05pF	GJM0335G2A8R1WB01#				±0.25pF	GJM0335G2A9R4CB01#	
			±0.1pF	GJM0335G2A8R1BB01#				±0.5pF	GJM0335G2A9R4DB01#	
			±0.25pF	GJM0335G2A8R1CB01#			9.5pF	±0.05pF	GJM0335G2A9R5WB01#	
			±0.5pF	GJM0335G2A8R1DB01#				±0.1pF	GJM0335G2A9R5BB01#	
		8.2pF	±0.05pF	GJM0335G2A8R2WB01#				±0.25pF	GJM0335G2A9R5CB01#	
			±0.1pF	GJM0335G2A8R2BB01#				±0.5pF	GJM0335G2A9R5DB01#	
			±0.25pF	GJM0335G2A8R2CB01#			9.6pF	±0.05pF	GJM0335G2A9R6WB01#	
			±0.5pF	GJM0335G2A8R2DB01#				±0.1pF	GJM0335G2A9R6BB01#	
		8.3pF	±0.05pF	GJM0335G2A8R3WB01#				±0.25pF	GJM0335G2A9R6CB01#	
			±0.1pF	GJM0335G2A8R3BB01#				±0.5pF	GJM0335G2A9R6DB01#	
			±0.25pF	GJM0335G2A8R3CB01#			9.7pF	±0.05pF	GJM0335G2A9R7WB01#	
			±0.5pF	GJM0335G2A8R3DB01#				±0.1pF	GJM0335G2A9R7BB01#	
		8.4pF	±0.05pF	GJM0335G2A8R4WB01#				±0.25pF	GJM0335G2A9R7CB01#	
			±0.1pF	GJM0335G2A8R4BB01#				±0.5pF	GJM0335G2A9R7DB01#	

- GRM
- GR3
- GRJ
- GR4
- GJM
- GQM
- GQ2
- GA2
- GA3
- GA3
- GA3
- GA3
- LL
- LLA
- LLM
- LLR
- NFM
- GJ4
- ZRA
- ZRB
- KRM
- KR3
- GMA
- GMD
- △Caution / Notice

Part number # indicates the package specification code.

GJM Series Temperature Compensating Type **High Q** Part Number List

(→ 0.6×0.3mm)

Rated Voltage	TC Code	Cap.	Tol.	Part Number		Rated Voltage	TC Code	Cap.	Tol.	Part Number								
100Vdc	X8G	9.8pF	±0.05pF	GJM0335G2A9R8WB01#	D1	50Vdc	COG	1.6pF	±0.25pF	GJM0335C1H1R6CB01#	D1							
			±0.1pF	GJM0335G2A9R8BB01#	D1				1.7pF	±0.05pF	GJM0335C1H1R7WB01#	D1						
			±0.25pF	GJM0335G2A9R8CB01#	D1					±0.1pF	GJM0335C1H1R7BB01#	D1						
			±0.5pF	GJM0335G2A9R8DB01#	D1					±0.25pF	GJM0335C1H1R7CB01#	D1						
		9.9pF	±0.05pF	GJM0335G2A9R9WB01#	D1			1.8pF		±0.05pF	GJM0335C1H1R8WB01#	D1						
			±0.1pF	GJM0335G2A9R9BB01#	D1				±0.1pF	GJM0335C1H1R8BB01#	D1							
			±0.25pF	GJM0335G2A9R9CB01#	D1				±0.25pF	GJM0335C1H1R8CB01#	D1							
			±0.5pF	GJM0335G2A9R9DB01#	D1				1.9pF	±0.05pF	GJM0335C1H1R9WB01#	D1						
		10pF	±2%	GJM0335G2A100GB01#	D1			±0.1pF		GJM0335C1H1R9BB01#	D1							
			±5%	GJM0335G2A100JB01#	D1			±0.25pF		GJM0335C1H1R9CB01#	D1							
		11pF	±2%	GJM0335G2A110GB01#	D1			2.0pF		±0.05pF	GJM0335C1H2R0WB01#	D1						
			±5%	GJM0335G2A110JB01#	D1				±0.1pF	GJM0335C1H2R0BB01#	D1							
		12pF	±2%	GJM0335G2A120GB01#	D1			±0.25pF	GJM0335C1H2R0CB01#	D1	2.1pF	±0.05pF	GJM0335C1H2R1WB01#	D1				
			±5%	GJM0335G2A120JB01#	D1			2.2pF	±0.05pF	GJM0335C1H2R2WB01#		D1						
		13pF	±2%	GJM0335G2A130GB01#	D1				±0.1pF	GJM0335C1H2R2BB01#		D1	±0.1pF	GJM0335C1H2R1BB01#	D1			
			±5%	GJM0335G2A130JB01#	D1			±0.25pF	GJM0335C1H2R1CB01#	D1		2.3pF	±0.05pF	GJM0335C1H2R2WB01#	D1			
		15pF	±2%	GJM0335G2A150GB01#	D1			±0.1pF	GJM0335C1H2R2BB01#	D1	±0.1pF		GJM0335C1H2R2WB01#	D1				
			±5%	GJM0335G2A150JB01#	D1			±0.25pF	GJM0335C1H2R2CB01#	D1	±0.25pF	GJM0335C1H2R2CB01#	D1					
		50Vdc	COG	0.20pF	±0.05pF			GJM0335C1HR20WB01#	D1			2.4pF	±0.05pF	GJM0335C1H2R4WB01#	D1			
					±0.1pF			GJM0335C1HR20BB01#	D1				±0.1pF	GJM0335C1H2R4BB01#	D1			
				0.30pF	±0.05pF			GJM0335C1HR30WB01#	D1			±0.25pF	GJM0335C1H2R4CB01#	D1	2.5pF	±0.05pF	GJM0335C1H2R5WB01#	D1
					±0.1pF			GJM0335C1HR30BB01#	D1			±0.1pF	GJM0335C1H2R5BB01#	D1		±0.1pF	GJM0335C1H2R5WB01#	D1
				0.40pF	±0.05pF			GJM0335C1HR40WB01#	D1			±0.25pF	GJM0335C1H2R5CB01#	D1	2.6pF	±0.05pF	GJM0335C1H2R6WB01#	D1
					±0.1pF			GJM0335C1HR40BB01#	D1			±0.1pF	GJM0335C1H2R6BB01#	D1		±0.1pF	GJM0335C1H2R6WB01#	D1
0.50pF	±0.05pF			GJM0335C1HR50WB01#	D1	±0.25pF	GJM0335C1H2R6CB01#	D1	2.7pF			±0.05pF	GJM0335C1H2R7WB01#	D1				
	±0.1pF			GJM0335C1HR50BB01#	D1	±0.1pF	GJM0335C1H2R7BB01#	D1				±0.1pF	GJM0335C1H2R7WB01#	D1				
0.60pF	±0.05pF			GJM0335C1HR60WB01#	D1	±0.25pF	GJM0335C1H2R7CB01#	D1	2.8pF			±0.05pF	GJM0335C1H2R8WB01#	D1				
	±0.1pF			GJM0335C1HR60BB01#	D1	±0.1pF	GJM0335C1H2R8BB01#	D1				±0.1pF	GJM0335C1H2R8WB01#	D1				
0.70pF	±0.05pF			GJM0335C1HR70WB01#	D1	±0.25pF	GJM0335C1H2R8CB01#	D1	2.9pF			±0.05pF	GJM0335C1H2R9WB01#	D1				
	±0.1pF			GJM0335C1HR70BB01#	D1	±0.1pF	GJM0335C1H2R9BB01#	D1				±0.1pF	GJM0335C1H2R9WB01#	D1				
0.80pF	±0.05pF			GJM0335C1HR80WB01#	D1	±0.25pF	GJM0335C1H2R9CB01#	D1	3.0pF			±0.05pF	GJM0335C1H3R0WB01#	D1				
	±0.1pF			GJM0335C1HR80BB01#	D1	±0.1pF	GJM0335C1H3R0BB01#	D1				±0.1pF	GJM0335C1H3R0WB01#	D1				
0.90pF	±0.05pF			GJM0335C1HR90WB01#	D1	±0.25pF	GJM0335C1H3R0CB01#	D1	3.1pF			±0.05pF	GJM0335C1H3R1WB01#	D1				
	±0.1pF			GJM0335C1HR90BB01#	D1	±0.1pF	GJM0335C1H3R1BB01#	D1				±0.1pF	GJM0335C1H3R1WB01#	D1				
1.0pF	±0.05pF			GJM0335C1H1R0WB01#	D1	±0.25pF	GJM0335C1H3R1CB01#	D1	3.2pF			±0.05pF	GJM0335C1H3R2WB01#	D1				
	±0.1pF			GJM0335C1H1R0BB01#	D1	±0.1pF	GJM0335C1H3R2BB01#	D1				±0.1pF	GJM0335C1H3R2WB01#	D1				
	±0.25pF			GJM0335C1H1R0CB01#	D1	±0.25pF	GJM0335C1H3R2CB01#	D1				±0.25pF	GJM0335C1H3R2CB01#	D1				
1.1pF	±0.05pF			GJM0335C1H1R1WB01#	D1	±0.1pF	GJM0335C1H1R1BB01#	D1	3.3pF			±0.05pF	GJM0335C1H3R3WB01#	D1				
	±0.1pF			GJM0335C1H1R1BB01#	D1	±0.25pF	GJM0335C1H1R1CB01#	D1				±0.1pF	GJM0335C1H3R3BB01#	D1				
	±0.25pF			GJM0335C1H1R1CB01#	D1	±0.1pF	GJM0335C1H1R5WB01#	D1				±0.1pF	GJM0335C1H3R3BB01#	D1				
1.2pF	±0.05pF			GJM0335C1H1R2WB01#	D1	±0.25pF	GJM0335C1H1R5CB01#	D1	3.4pF			±0.05pF	GJM0335C1H3R4WB01#	D1				
	±0.1pF			GJM0335C1H1R2BB01#	D1	±0.1pF	GJM0335C1H1R6WB01#	D1				±0.1pF	GJM0335C1H3R4WB01#	D1				
	±0.25pF			GJM0335C1H1R2CB01#	D1	±0.1pF	GJM0335C1H1R6BB01#	D1				±0.1pF	GJM0335C1H3R4BB01#	D1				

Part number # indicates the package specification code.

GJM Series Temperature Compensating Type **High Q** Part Number List

(→ 0.6×0.3mm)

Rated Voltage	TC Code	Cap.	Tol.	Part Number		Rated Voltage	TC Code	Cap.	Tol.	Part Number		
50Vdc	COG	3.4pF	±0.25pF	GJM0335C1H3R4CB01#	D1	50Vdc	COG	5.2pF	±0.1pF	GJM0335C1H5R2BB01#	D1	
			±0.05pF	GJM0335C1H3R5WB01#	D1				±0.25pF	GJM0335C1H5R2CB01#	D1	
			±0.1pF	GJM0335C1H3R5BB01#	D1				±0.5pF	GJM0335C1H5R2DB01#	D1	
		±0.25pF	GJM0335C1H3R5CB01#	D1	5.3pF			±0.05pF	GJM0335C1H5R3WB01#	D1		
		±0.05pF	GJM0335C1H3R6WB01#	D1				±0.1pF	GJM0335C1H5R3BB01#	D1		
		±0.1pF	GJM0335C1H3R6BB01#	D1				±0.25pF	GJM0335C1H5R3CB01#	D1		
		3.6pF	±0.25pF	GJM0335C1H3R6CB01#	D1			±0.5pF	GJM0335C1H5R3DB01#	D1		
			3.7pF	±0.05pF	GJM0335C1H3R7WB01#			D1	5.4pF	±0.05pF	GJM0335C1H5R4WB01#	D1
				±0.1pF	GJM0335C1H3R7BB01#			D1		±0.1pF	GJM0335C1H5R4BB01#	D1
		±0.25pF		GJM0335C1H3R7CB01#	D1			±0.25pF		GJM0335C1H5R4CB01#	D1	
		3.8pF	±0.05pF	GJM0335C1H3R8WB01#	D1			±0.5pF	GJM0335C1H5R4DB01#	D1		
			±0.1pF	GJM0335C1H3R8BB01#	D1			5.5pF	±0.05pF	GJM0335C1H5R5WB01#	D1	
			±0.25pF	GJM0335C1H3R8CB01#	D1				±0.1pF	GJM0335C1H5R5BB01#	D1	
		3.9pF	±0.05pF	GJM0335C1H3R9WB01#	D1				±0.25pF	GJM0335C1H5R5CB01#	D1	
			±0.1pF	GJM0335C1H3R9BB01#	D1			±0.5pF	GJM0335C1H5R5DB01#	D1		
			±0.25pF	GJM0335C1H3R9CB01#	D1			5.6pF	±0.05pF	GJM0335C1H5R6WB01#	D1	
		4.0pF	±0.05pF	GJM0335C1H4R0WB01#	D1				±0.1pF	GJM0335C1H5R6BB01#	D1	
			±0.1pF	GJM0335C1H4R0BB01#	D1				±0.25pF	GJM0335C1H5R6CB01#	D1	
			±0.25pF	GJM0335C1H4R0CB01#	D1			±0.5pF	GJM0335C1H5R6DB01#	D1		
		4.1pF	±0.05pF	GJM0335C1H4R1WB01#	D1			5.7pF	±0.05pF	GJM0335C1H5R7WB01#	D1	
			±0.1pF	GJM0335C1H4R1BB01#	D1				±0.1pF	GJM0335C1H5R7BB01#	D1	
			±0.25pF	GJM0335C1H4R1CB01#	D1				±0.25pF	GJM0335C1H5R7CB01#	D1	
		4.2pF	±0.05pF	GJM0335C1H4R2WB01#	D1			±0.5pF	GJM0335C1H5R7DB01#	D1		
			±0.1pF	GJM0335C1H4R2BB01#	D1			5.8pF	±0.05pF	GJM0335C1H5R8WB01#	D1	
			±0.25pF	GJM0335C1H4R2CB01#	D1				±0.1pF	GJM0335C1H5R8BB01#	D1	
		4.3pF	±0.05pF	GJM0335C1H4R3WB01#	D1				±0.25pF	GJM0335C1H5R8CB01#	D1	
			±0.1pF	GJM0335C1H4R3BB01#	D1			±0.5pF	GJM0335C1H5R8DB01#	D1		
			±0.25pF	GJM0335C1H4R3CB01#	D1			5.9pF	±0.05pF	GJM0335C1H5R9WB01#	D1	
		4.4pF	±0.05pF	GJM0335C1H4R4WB01#	D1				±0.1pF	GJM0335C1H5R9BB01#	D1	
			±0.1pF	GJM0335C1H4R4BB01#	D1				±0.25pF	GJM0335C1H5R9CB01#	D1	
			±0.25pF	GJM0335C1H4R4CB01#	D1			±0.5pF	GJM0335C1H5R9DB01#	D1		
		4.5pF	±0.05pF	GJM0335C1H4R5WB01#	D1			6.0pF	±0.05pF	GJM0335C1H6R0WB01#	D1	
			±0.1pF	GJM0335C1H4R5BB01#	D1				±0.1pF	GJM0335C1H6R0BB01#	D1	
			±0.25pF	GJM0335C1H4R5CB01#	D1				±0.25pF	GJM0335C1H6R0CB01#	D1	
		4.6pF	±0.05pF	GJM0335C1H4R6WB01#	D1			±0.5pF	GJM0335C1H6R0DB01#	D1		
			±0.1pF	GJM0335C1H4R6BB01#	D1			6.1pF	±0.05pF	GJM0335C1H6R1WB01#	D1	
			±0.25pF	GJM0335C1H4R6CB01#	D1				±0.1pF	GJM0335C1H6R1BB01#	D1	
		4.7pF	±0.05pF	GJM0335C1H4R7WB01#	D1				±0.25pF	GJM0335C1H6R1CB01#	D1	
			±0.1pF	GJM0335C1H4R7BB01#	D1			±0.5pF	GJM0335C1H6R1DB01#	D1		
			±0.25pF	GJM0335C1H4R7CB01#	D1			6.2pF	±0.05pF	GJM0335C1H6R2WB01#	D1	
		4.8pF	±0.05pF	GJM0335C1H4R8WB01#	D1				±0.1pF	GJM0335C1H6R2BB01#	D1	
			±0.1pF	GJM0335C1H4R8BB01#	D1				±0.25pF	GJM0335C1H6R2CB01#	D1	
			±0.25pF	GJM0335C1H4R8CB01#	D1			±0.5pF	GJM0335C1H6R2DB01#	D1		
		4.9pF	±0.05pF	GJM0335C1H4R9WB01#	D1			6.3pF	±0.05pF	GJM0335C1H6R3WB01#	D1	
			±0.1pF	GJM0335C1H4R9BB01#	D1				±0.1pF	GJM0335C1H6R3BB01#	D1	
			±0.25pF	GJM0335C1H4R9CB01#	D1				±0.25pF	GJM0335C1H6R3CB01#	D1	
		5.0pF	±0.05pF	GJM0335C1H5R0WB01#	D1			±0.5pF	GJM0335C1H6R3DB01#	D1		
			±0.1pF	GJM0335C1H5R0BB01#	D1			6.4pF	±0.05pF	GJM0335C1H6R4WB01#	D1	
			±0.25pF	GJM0335C1H5R0CB01#	D1				±0.1pF	GJM0335C1H6R4BB01#	D1	
		5.1pF	±0.05pF	GJM0335C1H5R1WB01#	D1				±0.25pF	GJM0335C1H6R4CB01#	D1	
			±0.1pF	GJM0335C1H5R1BB01#	D1			±0.5pF	GJM0335C1H6R4DB01#	D1		
			±0.25pF	GJM0335C1H5R1CB01#	D1			6.5pF	±0.05pF	GJM0335C1H6R5WB01#	D1	
±0.5pF	GJM0335C1H5R1DB01#	D1	±0.1pF	GJM0335C1H6R5BB01#	D1							
±0.25pF	GJM0335C1H5R2WB01#	D1	±0.25pF	GJM0335C1H6R5CB01#	D1							

Part number # indicates the package specification code.

GRM
 GR3
 GRJ
 GR4
 GJM
 GQM
 GA2
 GA3 GB
 GA3 GD
 GA3 GF
 LLL
 LLA
 LLM
 LLR
 NFM
 GJ4
 ZRA
 ZRB
 KRM
 KR3
 GMA
 GMD
 ⚠Caution /Notice

GJM Series Temperature Compensating Type **High Q** Part Number List

(→ 0.6×0.3mm)

Rated Voltage	TC Code	Cap.	Tol.	Part Number		Rated Voltage	TC Code	Cap.	Tol.	Part Number	
50Vdc	COG	6.5pF	±0.5pF	GJM0335C1H6R5DB01#	D1	50Vdc	COG	7.9pF	±0.1pF	GJM0335C1H7R9BB01#	
			±0.05pF	GJM0335C1H6R6WB01#	D1				±0.25pF	GJM0335C1H7R9CB01#	
		6.6pF	±0.1pF	GJM0335C1H6R6BB01#	D1			±0.5pF	GJM0335C1H7R9DB01#		
			±0.25pF	GJM0335C1H6R6CB01#	D1			8.0pF	±0.05pF	GJM0335C1H8R0WB01#	
			±0.5pF	GJM0335C1H6R6DB01#	D1				±0.1pF	GJM0335C1H8R0BB01#	
			6.7pF	±0.05pF	GJM0335C1H6R7WB01#			D1	±0.25pF	GJM0335C1H8R0CB01#	
		±0.1pF		GJM0335C1H6R7BB01#	D1			±0.5pF	GJM0335C1H8R0DB01#		
		±0.25pF		GJM0335C1H6R7CB01#	D1			8.1pF	±0.05pF	GJM0335C1H8R1WB01#	
		±0.5pF		GJM0335C1H6R7DB01#	D1				±0.1pF	GJM0335C1H8R1BB01#	
		6.8pF	±0.05pF	GJM0335C1H6R8WB01#	D1				±0.25pF	GJM0335C1H8R1CB01#	
			±0.1pF	GJM0335C1H6R8BB01#	D1			±0.5pF	GJM0335C1H8R1DB01#		
			±0.25pF	GJM0335C1H6R8CB01#	D1			8.2pF	±0.05pF	GJM0335C1H8R2WB01#	
		±0.5pF	GJM0335C1H6R8DB01#	D1	±0.1pF				GJM0335C1H8R2BB01#		
		6.9pF	±0.05pF	GJM0335C1H6R9WB01#					±0.25pF	GJM0335C1H8R2CB01#	
			±0.1pF	GJM0335C1H6R9BB01#					±0.5pF	GJM0335C1H8R2DB01#	
			±0.25pF	GJM0335C1H6R9CB01#				8.3pF	±0.05pF	GJM0335C1H8R3WB01#	
			±0.5pF	GJM0335C1H6R9DB01#					±0.1pF	GJM0335C1H8R3BB01#	
		7.0pF	±0.05pF	GJM0335C1H7R0WB01#					±0.25pF	GJM0335C1H8R3CB01#	
			±0.1pF	GJM0335C1H7R0BB01#				±0.5pF	GJM0335C1H8R3DB01#		
			±0.25pF	GJM0335C1H7R0CB01#				8.4pF	±0.05pF	GJM0335C1H8R4WB01#	
		±0.5pF	GJM0335C1H7R0DB01#		±0.1pF				GJM0335C1H8R4BB01#		
		7.1pF	±0.05pF	GJM0335C1H7R1WB01#					±0.25pF	GJM0335C1H8R4CB01#	
			±0.1pF	GJM0335C1H7R1BB01#					±0.5pF	GJM0335C1H8R4DB01#	
			±0.25pF	GJM0335C1H7R1CB01#				8.5pF	±0.05pF	GJM0335C1H8R5WB01#	
			±0.5pF	GJM0335C1H7R1DB01#					±0.1pF	GJM0335C1H8R5BB01#	
		7.2pF	±0.05pF	GJM0335C1H7R2WB01#					±0.25pF	GJM0335C1H8R5CB01#	
			±0.1pF	GJM0335C1H7R2BB01#				±0.5pF	GJM0335C1H8R5DB01#		
			±0.25pF	GJM0335C1H7R2CB01#				8.6pF	±0.05pF	GJM0335C1H8R6WB01#	
		±0.5pF	GJM0335C1H7R2DB01#		±0.1pF				GJM0335C1H8R6BB01#		
		7.3pF	±0.05pF	GJM0335C1H7R3WB01#					±0.25pF	GJM0335C1H8R6CB01#	
			±0.1pF	GJM0335C1H7R3BB01#					±0.5pF	GJM0335C1H8R6DB01#	
			±0.25pF	GJM0335C1H7R3CB01#				8.7pF	±0.05pF	GJM0335C1H8R7WB01#	
			±0.5pF	GJM0335C1H7R3DB01#					±0.1pF	GJM0335C1H8R7BB01#	
		7.4pF	±0.05pF	GJM0335C1H7R4WB01#					±0.25pF	GJM0335C1H8R7CB01#	
			±0.1pF	GJM0335C1H7R4BB01#				±0.5pF	GJM0335C1H8R7DB01#		
			±0.25pF	GJM0335C1H7R4CB01#				8.8pF	±0.05pF	GJM0335C1H8R8WB01#	
		±0.5pF	GJM0335C1H7R4DB01#		±0.1pF				GJM0335C1H8R8BB01#		
		7.5pF	±0.05pF	GJM0335C1H7R5WB01#					±0.25pF	GJM0335C1H8R8CB01#	
			±0.1pF	GJM0335C1H7R5BB01#					±0.5pF	GJM0335C1H8R8DB01#	
			±0.25pF	GJM0335C1H7R5CB01#				8.9pF	±0.05pF	GJM0335C1H8R9WB01#	
			±0.5pF	GJM0335C1H7R5DB01#					±0.1pF	GJM0335C1H8R9BB01#	
		7.6pF	±0.05pF	GJM0335C1H7R6WB01#					±0.25pF	GJM0335C1H8R9CB01#	
			±0.1pF	GJM0335C1H7R6BB01#				±0.5pF	GJM0335C1H8R9DB01#		
			±0.25pF	GJM0335C1H7R6CB01#				9.0pF	±0.05pF	GJM0335C1H9R0WB01#	
			±0.5pF	GJM0335C1H7R6DB01#					±0.1pF	GJM0335C1H9R0BB01#	
		7.7pF	±0.05pF	GJM0335C1H7R7WB01#					±0.25pF	GJM0335C1H9R0CB01#	
			±0.1pF	GJM0335C1H7R7BB01#					±0.5pF	GJM0335C1H9R0DB01#	
			±0.25pF	GJM0335C1H7R7CB01#				9.1pF	±0.05pF	GJM0335C1H9R1WB01#	
			±0.5pF	GJM0335C1H7R7DB01#					±0.1pF	GJM0335C1H9R1BB01#	
		7.8pF	±0.05pF	GJM0335C1H7R8WB01#					±0.25pF	GJM0335C1H9R1CB01#	
			±0.1pF	GJM0335C1H7R8BB01#				±0.5pF	GJM0335C1H9R1DB01#		
			±0.25pF	GJM0335C1H7R8CB01#				9.2pF	±0.05pF	GJM0335C1H9R2WB01#	
			±0.5pF	GJM0335C1H7R8DB01#					±0.1pF	GJM0335C1H9R2BB01#	
		±0.05pF	GJM0335C1H7R9WB01#		±0.25pF				GJM0335C1H9R2CB01#		

Part number # indicates the package specification code.

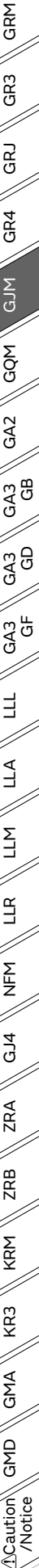

GJM Series Temperature Compensating Type **High Q** Part Number List

(→ 0.6×0.3mm)

Rated Voltage	TC Code	Cap.	Tol.	Part Number		Rated Voltage	TC Code	Cap.	Tol.	Part Number		
50Vdc	COG	9.2pF	±0.5pF	GJM0335C1H9R2DB01#		50Vdc	CH	4.5pF	±0.05pF	GJM0332C1H4R5WB01#	D1	
			±0.05pF	GJM0335C1H9R3WB01#					±0.1pF	GJM0332C1H4R5BB01#	D1	
			±0.1pF	GJM0335C1H9R3BB01#					±0.25pF	GJM0332C1H4R5CB01#	D1	
			±0.25pF	GJM0335C1H9R3CB01#					4.6pF	±0.05pF	GJM0332C1H4R6WB01#	D1
		±0.5pF	GJM0335C1H9R3DB01#		±0.1pF			GJM0332C1H4R6BB01#		D1		
		9.4pF	±0.05pF	GJM0335C1H9R4WB01#				±0.25pF		GJM0332C1H4R6CB01#	D1	
			±0.1pF	GJM0335C1H9R4BB01#				4.7pF		±0.05pF	GJM0332C1H4R7WB01#	D1
			±0.25pF	GJM0335C1H9R4CB01#					±0.1pF	GJM0332C1H4R7BB01#	D1	
			±0.5pF	GJM0335C1H9R4DB01#					±0.25pF	GJM0332C1H4R7CB01#	D1	
		9.5pF	±0.05pF	GJM0335C1H9R5WB01#					4.8pF	±0.05pF	GJM0332C1H4R8WB01#	D1
			±0.1pF	GJM0335C1H9R5BB01#				±0.1pF		GJM0332C1H4R8BB01#	D1	
			±0.25pF	GJM0335C1H9R5CB01#				±0.25pF		GJM0332C1H4R8CB01#	D1	
			±0.5pF	GJM0335C1H9R5DB01#				4.9pF		±0.05pF	GJM0332C1H4R9WB01#	D1
		9.6pF	±0.05pF	GJM0335C1H9R6WB01#					±0.1pF	GJM0332C1H4R9BB01#	D1	
			±0.1pF	GJM0335C1H9R6BB01#					±0.25pF	GJM0332C1H4R9CB01#	D1	
			±0.25pF	GJM0335C1H9R6CB01#					5.0pF	±0.05pF	GJM0332C1H5R0WB01#	D1
			±0.5pF	GJM0335C1H9R6DB01#				±0.1pF		GJM0332C1H5R0BB01#	D1	
		9.7pF	±0.05pF	GJM0335C1H9R7WB01#				±0.25pF		GJM0332C1H5R0CB01#	D1	
			±0.1pF	GJM0335C1H9R7BB01#				5.1pF		±0.05pF	GJM0332C1H5R1WB01#	D1
			±0.25pF	GJM0335C1H9R7CB01#					±0.1pF	GJM0332C1H5R1BB01#	D1	
			±0.5pF	GJM0335C1H9R7DB01#					±0.25pF	GJM0332C1H5R1CB01#	D1	
		9.8pF	±0.05pF	GJM0335C1H9R8WB01#					±0.5pF	GJM0332C1H5R1DB01#	D1	
			±0.1pF	GJM0335C1H9R8BB01#				5.2pF	±0.05pF	GJM0332C1H5R2WB01#	D1	
			±0.25pF	GJM0335C1H9R8CB01#					±0.1pF	GJM0332C1H5R2BB01#	D1	
			±0.5pF	GJM0335C1H9R8DB01#					±0.25pF	GJM0332C1H5R2CB01#	D1	
		9.9pF	±0.05pF	GJM0335C1H9R9WB01#					±0.5pF	GJM0332C1H5R2DB01#	D1	
			±0.1pF	GJM0335C1H9R9BB01#				5.3pF	±0.05pF	GJM0332C1H5R3WB01#	D1	
			±0.25pF	GJM0335C1H9R9CB01#					±0.1pF	GJM0332C1H5R3BB01#	D1	
			±0.5pF	GJM0335C1H9R9DB01#					±0.25pF	GJM0332C1H5R3CB01#	D1	
		10pF	±2%	GJM0335C1H100GB01#					±0.5pF	GJM0332C1H5R3DB01#	D1	
			±5%	GJM0335C1H100JB01#				5.4pF	±0.05pF	GJM0332C1H5R4WB01#	D1	
			11pF	±2%	GJM0335C1H110GB01#					±0.1pF	GJM0332C1H5R4BB01#	D1
				±5%	GJM0335C1H110JB01#					±0.25pF	GJM0332C1H5R4CB01#	D1
		12pF		±2%	GJM0335C1H120GB01#					±0.5pF	GJM0332C1H5R4DB01#	D1
				±5%	GJM0335C1H120JB01#				5.5pF	±0.05pF	GJM0332C1H5R5WB01#	D1
			13pF	±2%	GJM0335C1H130GB01#					±0.1pF	GJM0332C1H5R5BB01#	D1
				±5%	GJM0335C1H130JB01#					±0.25pF	GJM0332C1H5R5CB01#	D1
		15pF		±2%	GJM0335C1H150GB01#					±0.5pF	GJM0332C1H5R5DB01#	D1
				±5%	GJM0335C1H150JB01#				5.6pF	±0.05pF	GJM0332C1H5R6WB01#	D1
			4.0pF	±0.05pF	GJM0332C1H4R0WB01#			D1		±0.1pF	GJM0332C1H5R6BB01#	D1
				±0.1pF	GJM0332C1H4R0BB01#			D1		±0.25pF	GJM0332C1H5R6CB01#	D1
		±0.25pF		GJM0332C1H4R0CB01#	D1			±0.5pF		GJM0332C1H5R6DB01#	D1	
		4.1pF		±0.05pF	GJM0332C1H4R1WB01#			D1	5.7pF	±0.05pF	GJM0332C1H5R7WB01#	D1
			±0.1pF	GJM0332C1H4R1BB01#	D1			±0.1pF		GJM0332C1H5R7BB01#	D1	
			±0.25pF	GJM0332C1H4R1CB01#	D1			±0.25pF		GJM0332C1H5R7CB01#	D1	
			4.2pF	±0.05pF	GJM0332C1H4R2WB01#			D1		±0.5pF	GJM0332C1H5R7DB01#	D1
		±0.1pF		GJM0332C1H4R2BB01#	D1			5.8pF	±0.05pF	GJM0332C1H5R8WB01#	D1	
		±0.25pF		GJM0332C1H4R2CB01#	D1				±0.1pF	GJM0332C1H5R8BB01#	D1	
4.3pF	±0.05pF	GJM0332C1H4R3WB01#		D1	±0.25pF	GJM0332C1H5R8CB01#	D1					
	±0.1pF	GJM0332C1H4R3BB01#	D1	±0.5pF	GJM0332C1H5R8DB01#	D1						
	±0.25pF	GJM0332C1H4R3CB01#	D1	5.9pF	±0.05pF	GJM0332C1H5R9WB01#	D1					
	4.4pF	±0.05pF	GJM0332C1H4R4WB01#		D1	±0.1pF	GJM0332C1H5R9BB01#	D1				
±0.1pF		GJM0332C1H4R4BB01#	D1		±0.25pF	GJM0332C1H5R9CB01#	D1					
±0.25pF		GJM0332C1H4R4CB01#	D1		±0.5pF	GJM0332C1H5R9DB01#	D1					

Part number # indicates the package specification code.

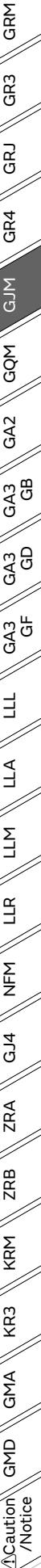

GJM Series Temperature Compensating Type **High Q** Part Number List

(→ 0.6×0.3mm)

Rated Voltage	TC Code	Cap.	Tol.	Part Number		Rated Voltage	TC Code	Cap.	Tol.	Part Number			
50Vdc	CH	6.0pF	±0.05pF	GJM0332C1H6R0WB01#	D1	50Vdc	CK	1.3pF	±0.1pF	GJM0334C1H1R3BB01#	D1		
			±0.1pF	GJM0332C1H6R0BB01#	D1			1.5pF	±0.1pF	GJM0334C1H1R5BB01#	D1		
			±0.25pF	GJM0332C1H6R0CB01#	D1			1.6pF	±0.1pF	GJM0334C1H1R6BB01#	D1		
			±0.5pF	GJM0332C1H6R0DB01#	D1			1.8pF	±0.1pF	GJM0334C1H1R8BB01#	D1		
		6.1pF	±0.05pF	GJM0332C1H6R1WB01#	D1	25Vdc	COG	0.20pF	±0.05pF	GJM0335C1ER20WB01#			
			±0.1pF	GJM0332C1H6R1BB01#	D1				±0.1pF	GJM0335C1ER20BB01#			
			±0.25pF	GJM0332C1H6R1CB01#	D1			0.30pF	±0.05pF	GJM0335C1ER30WB01#			
			±0.5pF	GJM0332C1H6R1DB01#	D1				±0.1pF	GJM0335C1ER30BB01#			
		6.2pF	±0.05pF	GJM0332C1H6R2WB01#	D1	0.40pF	±0.05pF	GJM0335C1ER40WB01#					
			±0.1pF	GJM0332C1H6R2BB01#	D1		±0.1pF	GJM0335C1ER40BB01#					
			±0.25pF	GJM0332C1H6R2CB01#	D1	0.50pF	±0.05pF	GJM0335C1ER50WB01#					
			±0.5pF	GJM0332C1H6R2DB01#	D1		±0.1pF	GJM0335C1ER50BB01#					
		6.3pF	±0.05pF	GJM0332C1H6R3WB01#	D1	0.60pF	±0.05pF	GJM0335C1ER60WB01#					
			±0.1pF	GJM0332C1H6R3BB01#	D1		±0.1pF	GJM0335C1ER60BB01#					
			±0.25pF	GJM0332C1H6R3CB01#	D1	0.70pF	±0.05pF	GJM0335C1ER70WB01#					
			±0.5pF	GJM0332C1H6R3DB01#	D1		±0.1pF	GJM0335C1ER70BB01#					
		6.4pF	±0.05pF	GJM0332C1H6R4WB01#	D1	0.80pF	±0.05pF	GJM0335C1ER80WB01#					
			±0.1pF	GJM0332C1H6R4BB01#	D1		±0.1pF	GJM0335C1ER80BB01#					
			±0.25pF	GJM0332C1H6R4CB01#	D1	0.90pF	±0.05pF	GJM0335C1ER90WB01#					
			±0.5pF	GJM0332C1H6R4DB01#	D1		±0.1pF	GJM0335C1ER90BB01#					
		6.5pF	±0.05pF	GJM0332C1H6R5WB01#	D1	1.0pF	±0.05pF	GJM0335C1E1R0WB01#					
			±0.1pF	GJM0332C1H6R5BB01#	D1		±0.1pF	GJM0335C1E1R0BB01#					
			±0.25pF	GJM0332C1H6R5CB01#	D1		±0.25pF	GJM0335C1E1R0CB01#					
			±0.5pF	GJM0332C1H6R5DB01#	D1	1.1pF	±0.05pF	GJM0335C1E1R1WB01#					
		6.6pF	±0.05pF	GJM0332C1H6R6WB01#	D1		±0.1pF	GJM0335C1E1R1BB01#					
			±0.1pF	GJM0332C1H6R6BB01#	D1		±0.25pF	GJM0335C1E1R1CB01#					
			±0.25pF	GJM0332C1H6R6CB01#	D1	1.2pF	±0.05pF	GJM0335C1E1R2WB01#					
			±0.5pF	GJM0332C1H6R6DB01#	D1		±0.1pF	GJM0335C1E1R2BB01#					
		6.7pF	±0.05pF	GJM0332C1H6R7WB01#	D1		±0.25pF	GJM0335C1E1R2CB01#					
			±0.1pF	GJM0332C1H6R7BB01#	D1	1.3pF	±0.05pF	GJM0335C1E1R3WB01#					
			±0.25pF	GJM0332C1H6R7CB01#	D1		±0.1pF	GJM0335C1E1R3BB01#					
			±0.5pF	GJM0332C1H6R7DB01#	D1		±0.25pF	GJM0335C1E1R3CB01#					
		6.8pF	±0.05pF	GJM0332C1H6R8WB01#	D1	1.4pF	±0.05pF	GJM0335C1E1R4WB01#					
			±0.1pF	GJM0332C1H6R8BB01#	D1		±0.1pF	GJM0335C1E1R4BB01#					
			±0.25pF	GJM0332C1H6R8CB01#	D1		±0.25pF	GJM0335C1E1R4CB01#					
			±0.5pF	GJM0332C1H6R8DB01#	D1	1.5pF	±0.05pF	GJM0335C1E1R5WB01#					
		CJ	2.2pF	±0.1pF	GJM0333C1H2R2BB01#	D1		±0.1pF	GJM0335C1E1R5BB01#				
			2.4pF	±0.1pF	GJM0333C1H2R4BB01#	D1		±0.25pF	GJM0335C1E1R5CB01#				
			2.7pF	±0.1pF	GJM0333C1H2R7BB01#	D1	1.6pF	±0.05pF	GJM0335C1E1R6WB01#				
			3.0pF	±0.1pF	GJM0333C1H3R0BB01#	D1		±0.1pF	GJM0335C1E1R6BB01#				
			3.3pF	±0.1pF	GJM0333C1H3R3BB01#	D1		±0.25pF	GJM0335C1E1R6CB01#				
			3.6pF	±0.1pF	GJM0333C1H3R6BB01#	D1	1.7pF	±0.05pF	GJM0335C1E1R7WB01#				
		3.9pF	±0.1pF	GJM0333C1H3R9BB01#	D1		±0.1pF	GJM0335C1E1R7BB01#					
		CK	0.20pF	±0.05pF	GJM0334C1HR20WB01#	D1		±0.25pF	GJM0335C1E1R7CB01#				
			0.30pF	±0.05pF	GJM0334C1HR30WB01#	D1	1.8pF	±0.05pF	GJM0335C1E1R8WB01#				
			0.40pF	±0.05pF	GJM0334C1HR40WB01#	D1		±0.1pF	GJM0335C1E1R8BB01#				
			0.50pF	±0.05pF	GJM0334C1HR50WB01#	D1		±0.25pF	GJM0335C1E1R8CB01#				
			0.60pF	±0.05pF	GJM0334C1HR60WB01#	D1	1.9pF	±0.05pF	GJM0335C1E1R9WB01#				
0.70pF	±0.05pF		GJM0334C1HR70WB01#	D1		±0.1pF	GJM0335C1E1R9BB01#						
0.80pF	±0.05pF		GJM0334C1HR80WB01#	D1		±0.25pF	GJM0335C1E1R9CB01#						
0.90pF	±0.05pF		GJM0334C1HR90WB01#	D1	2.0pF	±0.05pF	GJM0335C1E2R0WB01#						
1.0pF	±0.1pF		GJM0334C1H1R0BB01#	D1		±0.1pF	GJM0335C1E2R0BB01#						
1.1pF	±0.1pF		GJM0334C1H1R1BB01#	D1		±0.25pF	GJM0335C1E2R0CB01#						
1.2pF	±0.1pF		GJM0334C1H1R2BB01#	D1									

Part number # indicates the package specification code.

GRM
 GR3
 GRJ
 GR4
 GJM
 GQM
 GA2
 GA3 GB
 GA3 GD
 GA3 GF
 LLL
 LLA
 LLM
 LLR
 NFM
 GJ4
 ZRA
 ZRB
 KRM
 KR3
 GMA
 GMD
 △Caution / Notice

GJM Series Temperature Compensating Type High Q Part Number List

(→ 0.6×0.3mm)

Rated Voltage	TC Code	Cap.	Tol.	Part Number	Rated Voltage	TC Code	Cap.	Tol.	Part Number
25Vdc	COG	2.1pF	±0.05pF	GJM0335C1E2R1WB01#	25Vdc	COG	3.9pF	±0.05pF	GJM0335C1E3R9WB01#
			±0.1pF	GJM0335C1E2R1BB01#				±0.1pF	GJM0335C1E3R9BB01#
			±0.25pF	GJM0335C1E2R1CB01#				±0.25pF	GJM0335C1E3R9CB01#
		2.2pF	±0.05pF	GJM0335C1E2R2WB01#			4.0pF	±0.05pF	GJM0335C1E4R0WB01#
			±0.1pF	GJM0335C1E2R2BB01#				±0.1pF	GJM0335C1E4R0BB01#
			±0.25pF	GJM0335C1E2R2CB01#				±0.25pF	GJM0335C1E4R0CB01#
		2.3pF	±0.05pF	GJM0335C1E2R3WB01#			4.1pF	±0.05pF	GJM0335C1E4R1WB01#
			±0.1pF	GJM0335C1E2R3BB01#				±0.1pF	GJM0335C1E4R1BB01#
			±0.25pF	GJM0335C1E2R3CB01#				±0.25pF	GJM0335C1E4R1CB01#
		2.4pF	±0.05pF	GJM0335C1E2R4WB01#			4.2pF	±0.05pF	GJM0335C1E4R2WB01#
			±0.1pF	GJM0335C1E2R4BB01#				±0.1pF	GJM0335C1E4R2BB01#
			±0.25pF	GJM0335C1E2R4CB01#				±0.25pF	GJM0335C1E4R2CB01#
		2.5pF	±0.05pF	GJM0335C1E2R5WB01#			4.3pF	±0.05pF	GJM0335C1E4R3WB01#
			±0.1pF	GJM0335C1E2R5BB01#				±0.1pF	GJM0335C1E4R3BB01#
			±0.25pF	GJM0335C1E2R5CB01#				±0.25pF	GJM0335C1E4R3CB01#
		2.6pF	±0.05pF	GJM0335C1E2R6WB01#			4.4pF	±0.05pF	GJM0335C1E4R4WB01#
			±0.1pF	GJM0335C1E2R6BB01#				±0.1pF	GJM0335C1E4R4BB01#
			±0.25pF	GJM0335C1E2R6CB01#				±0.25pF	GJM0335C1E4R4CB01#
		2.7pF	±0.05pF	GJM0335C1E2R7WB01#			4.5pF	±0.05pF	GJM0335C1E4R5WB01#
			±0.1pF	GJM0335C1E2R7BB01#				±0.1pF	GJM0335C1E4R5BB01#
			±0.25pF	GJM0335C1E2R7CB01#				±0.25pF	GJM0335C1E4R5CB01#
		2.8pF	±0.05pF	GJM0335C1E2R8WB01#			4.6pF	±0.05pF	GJM0335C1E4R6WB01#
			±0.1pF	GJM0335C1E2R8BB01#				±0.1pF	GJM0335C1E4R6BB01#
			±0.25pF	GJM0335C1E2R8CB01#				±0.25pF	GJM0335C1E4R6CB01#
		2.9pF	±0.05pF	GJM0335C1E2R9WB01#			4.7pF	±0.05pF	GJM0335C1E4R7WB01#
			±0.1pF	GJM0335C1E2R9BB01#				±0.1pF	GJM0335C1E4R7BB01#
			±0.25pF	GJM0335C1E2R9CB01#				±0.25pF	GJM0335C1E4R7CB01#
		3.0pF	±0.05pF	GJM0335C1E3R0WB01#			4.8pF	±0.05pF	GJM0335C1E4R8WB01#
			±0.1pF	GJM0335C1E3R0BB01#				±0.1pF	GJM0335C1E4R8BB01#
			±0.25pF	GJM0335C1E3R0CB01#				±0.25pF	GJM0335C1E4R8CB01#
		3.1pF	±0.05pF	GJM0335C1E3R1WB01#			4.9pF	±0.05pF	GJM0335C1E4R9WB01#
			±0.1pF	GJM0335C1E3R1BB01#				±0.1pF	GJM0335C1E4R9BB01#
			±0.25pF	GJM0335C1E3R1CB01#				±0.25pF	GJM0335C1E4R9CB01#
		3.2pF	±0.05pF	GJM0335C1E3R2WB01#			5.0pF	±0.05pF	GJM0335C1E5R0WB01#
			±0.1pF	GJM0335C1E3R2BB01#				±0.1pF	GJM0335C1E5R0BB01#
			±0.25pF	GJM0335C1E3R2CB01#				±0.25pF	GJM0335C1E5R0CB01#
		3.3pF	±0.05pF	GJM0335C1E3R3WB01#			5.1pF	±0.05pF	GJM0335C1E5R1WB01#
			±0.1pF	GJM0335C1E3R3BB01#				±0.1pF	GJM0335C1E5R1BB01#
			±0.25pF	GJM0335C1E3R3CB01#				±0.25pF	GJM0335C1E5R1CB01#
		3.4pF	±0.05pF	GJM0335C1E3R4WB01#			5.2pF	±0.05pF	GJM0335C1E5R2WB01#
			±0.1pF	GJM0335C1E3R4BB01#				±0.1pF	GJM0335C1E5R2BB01#
			±0.25pF	GJM0335C1E3R4CB01#				±0.25pF	GJM0335C1E5R2CB01#
		3.5pF	±0.05pF	GJM0335C1E3R5WB01#			5.3pF	±0.05pF	GJM0335C1E5R3WB01#
			±0.1pF	GJM0335C1E3R5BB01#				±0.1pF	GJM0335C1E5R3BB01#
			±0.25pF	GJM0335C1E3R5CB01#				±0.25pF	GJM0335C1E5R3CB01#
		3.6pF	±0.05pF	GJM0335C1E3R6WB01#			5.4pF	±0.05pF	GJM0335C1E5R4WB01#
			±0.1pF	GJM0335C1E3R6BB01#				±0.1pF	GJM0335C1E5R4BB01#
			±0.25pF	GJM0335C1E3R6CB01#				±0.25pF	GJM0335C1E5R4CB01#
		3.7pF	±0.05pF	GJM0335C1E3R7WB01#			5.5pF	±0.05pF	GJM0335C1E5R5WB01#
			±0.1pF	GJM0335C1E3R7BB01#				±0.1pF	GJM0335C1E5R5BB01#
			±0.25pF	GJM0335C1E3R7CB01#				±0.25pF	GJM0335C1E5R5CB01#
		3.8pF	±0.05pF	GJM0335C1E3R8WB01#					
			±0.1pF	GJM0335C1E3R8BB01#					
			±0.25pF	GJM0335C1E3R8CB01#					

Part number # indicates the package specification code.

- GRM
- GR3
- GRJ
- GR4
- GJM
- GQM
- GQ2
- GA2
- GA3 GB
- GA3 GD
- GA3 GF
- LLL
- LLA
- LLM
- LLR
- NFM
- GJ4
- ZRA
- ZRB
- KRM
- KR3
- GMA
- GMD
- ⚠Caution /Notice

GJM Series Temperature Compensating Type High Q Part Number List

(→ 0.6×0.3mm)

Rated Voltage	TC Code	Cap.	Tol.	Part Number	Rated Voltage	TC Code	Cap.	Tol.	Part Number
25Vdc	COG	5.5pF	±0.25pF	GJM0335C1E5R5CB01#	25Vdc	COG	6.9pF	±0.05pF	GJM0335C1E6R9WB01#
			±0.5pF	GJM0335C1E5R5DB01#				±0.1pF	GJM0335C1E6R9BB01#
		5.6pF	±0.05pF	GJM0335C1E5R6WB01#			±0.25pF	GJM0335C1E6R9CB01#	
			±0.1pF	GJM0335C1E5R6BB01#			±0.5pF	GJM0335C1E6R9DB01#	
			±0.25pF	GJM0335C1E5R6CB01#			7.0pF	±0.05pF	GJM0335C1E7R0WB01#
			±0.5pF	GJM0335C1E5R6DB01#				±0.1pF	GJM0335C1E7R0BB01#
		5.7pF	±0.05pF	GJM0335C1E5R7WB01#			±0.25pF	GJM0335C1E7R0CB01#	
			±0.1pF	GJM0335C1E5R7BB01#			±0.5pF	GJM0335C1E7R0DB01#	
			±0.25pF	GJM0335C1E5R7CB01#			7.1pF	±0.05pF	GJM0335C1E7R1WB01#
			±0.5pF	GJM0335C1E5R7DB01#				±0.1pF	GJM0335C1E7R1BB01#
		5.8pF	±0.05pF	GJM0335C1E5R8WB01#			±0.25pF	GJM0335C1E7R1CB01#	
			±0.1pF	GJM0335C1E5R8BB01#			±0.5pF	GJM0335C1E7R1DB01#	
			±0.25pF	GJM0335C1E5R8CB01#			7.2pF	±0.05pF	GJM0335C1E7R2WB01#
			±0.5pF	GJM0335C1E5R8DB01#				±0.1pF	GJM0335C1E7R2BB01#
		5.9pF	±0.05pF	GJM0335C1E5R9WB01#			±0.25pF	GJM0335C1E7R2CB01#	
			±0.1pF	GJM0335C1E5R9BB01#			±0.5pF	GJM0335C1E7R2DB01#	
			±0.25pF	GJM0335C1E5R9CB01#			7.3pF	±0.05pF	GJM0335C1E7R3WB01#
			±0.5pF	GJM0335C1E5R9DB01#				±0.1pF	GJM0335C1E7R3BB01#
		6.0pF	±0.05pF	GJM0335C1E6R0WB01#			±0.25pF	GJM0335C1E7R3CB01#	
			±0.1pF	GJM0335C1E6R0BB01#			±0.5pF	GJM0335C1E7R3DB01#	
			±0.25pF	GJM0335C1E6R0CB01#			7.4pF	±0.05pF	GJM0335C1E7R4WB01#
			±0.5pF	GJM0335C1E6R0DB01#				±0.1pF	GJM0335C1E7R4BB01#
		6.1pF	±0.05pF	GJM0335C1E6R1WB01#			±0.25pF	GJM0335C1E7R4CB01#	
			±0.1pF	GJM0335C1E6R1BB01#			±0.5pF	GJM0335C1E7R4DB01#	
			±0.25pF	GJM0335C1E6R1CB01#			7.5pF	±0.05pF	GJM0335C1E7R5WB01#
			±0.5pF	GJM0335C1E6R1DB01#				±0.1pF	GJM0335C1E7R5BB01#
		6.2pF	±0.05pF	GJM0335C1E6R2WB01#			±0.25pF	GJM0335C1E7R5CB01#	
			±0.1pF	GJM0335C1E6R2BB01#			±0.5pF	GJM0335C1E7R5DB01#	
			±0.25pF	GJM0335C1E6R2CB01#			7.6pF	±0.05pF	GJM0335C1E7R6WB01#
			±0.5pF	GJM0335C1E6R2DB01#				±0.1pF	GJM0335C1E7R6BB01#
		6.3pF	±0.05pF	GJM0335C1E6R3WB01#			±0.25pF	GJM0335C1E7R6CB01#	
			±0.1pF	GJM0335C1E6R3BB01#			±0.5pF	GJM0335C1E7R6DB01#	
			±0.25pF	GJM0335C1E6R3CB01#			7.7pF	±0.05pF	GJM0335C1E7R7WB01#
			±0.5pF	GJM0335C1E6R3DB01#				±0.1pF	GJM0335C1E7R7BB01#
		6.4pF	±0.05pF	GJM0335C1E6R4WB01#			±0.25pF	GJM0335C1E7R7CB01#	
			±0.1pF	GJM0335C1E6R4BB01#			±0.5pF	GJM0335C1E7R7DB01#	
			±0.25pF	GJM0335C1E6R4CB01#			7.8pF	±0.05pF	GJM0335C1E7R8WB01#
			±0.5pF	GJM0335C1E6R4DB01#				±0.1pF	GJM0335C1E7R8BB01#
		6.5pF	±0.05pF	GJM0335C1E6R5WB01#			±0.25pF	GJM0335C1E7R8CB01#	
			±0.1pF	GJM0335C1E6R5BB01#			±0.5pF	GJM0335C1E7R8DB01#	
			±0.25pF	GJM0335C1E6R5CB01#			7.9pF	±0.05pF	GJM0335C1E7R9WB01#
			±0.5pF	GJM0335C1E6R5DB01#				±0.1pF	GJM0335C1E7R9BB01#
		6.6pF	±0.05pF	GJM0335C1E6R6WB01#			±0.25pF	GJM0335C1E7R9CB01#	
			±0.1pF	GJM0335C1E6R6BB01#			±0.5pF	GJM0335C1E7R9DB01#	
			±0.25pF	GJM0335C1E6R6CB01#			8.0pF	±0.05pF	GJM0335C1E8R0WB01#
			±0.5pF	GJM0335C1E6R6DB01#				±0.1pF	GJM0335C1E8R0BB01#
		6.7pF	±0.05pF	GJM0335C1E6R7WB01#			±0.25pF	GJM0335C1E8R0CB01#	
			±0.1pF	GJM0335C1E6R7BB01#			±0.5pF	GJM0335C1E8R0DB01#	
±0.25pF	GJM0335C1E6R7CB01#		8.1pF	±0.05pF	GJM0335C1E8R1WB01#				
±0.5pF	GJM0335C1E6R7DB01#			±0.1pF	GJM0335C1E8R1BB01#				
6.8pF	±0.05pF	GJM0335C1E6R8WB01#	±0.25pF	GJM0335C1E8R1CB01#					
	±0.1pF	GJM0335C1E6R8BB01#	±0.5pF	GJM0335C1E8R1DB01#					
	±0.25pF	GJM0335C1E6R8CB01#	8.2pF	±0.05pF	GJM0335C1E8R2WB01#				
	±0.5pF	GJM0335C1E6R8DB01#		±0.1pF	GJM0335C1E8R2BB01#				

Part number # indicates the package specification code.

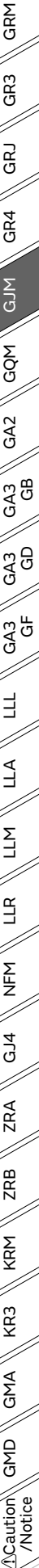

GJM Series Temperature Compensating Type High Q Part Number List

(→ 0.6×0.3mm)

Rated Voltage	TC Code	Cap.	Tol.	Part Number	Rated Voltage	TC Code	Cap.	Tol.	Part Number
25Vdc	COG	8.2pF	±0.25pF	GJM0335C1E8R2CB01#	25Vdc	COG	9.6pF	±0.05pF	GJM0335C1E9R6WB01#
			±0.5pF	GJM0335C1E8R2DB01#				±0.1pF	GJM0335C1E9R6BB01#
		8.3pF	±0.05pF	GJM0335C1E8R3WB01#				±0.25pF	GJM0335C1E9R6CB01#
			±0.1pF	GJM0335C1E8R3BB01#				±0.5pF	GJM0335C1E9R6DB01#
			±0.25pF	GJM0335C1E8R3CB01#			9.7pF	±0.05pF	GJM0335C1E9R7WB01#
			±0.5pF	GJM0335C1E8R3DB01#				±0.1pF	GJM0335C1E9R7BB01#
		8.4pF	±0.05pF	GJM0335C1E8R4WB01#				±0.25pF	GJM0335C1E9R7CB01#
			±0.1pF	GJM0335C1E8R4BB01#			±0.5pF	GJM0335C1E9R7DB01#	
			±0.25pF	GJM0335C1E8R4CB01#			9.8pF	±0.05pF	GJM0335C1E9R8WB01#
		±0.5pF	GJM0335C1E8R4DB01#	±0.1pF				GJM0335C1E9R8BB01#	
		8.5pF	±0.05pF	GJM0335C1E8R5WB01#				±0.25pF	GJM0335C1E9R8CB01#
			±0.1pF	GJM0335C1E8R5BB01#			±0.5pF	GJM0335C1E9R8DB01#	
			±0.25pF	GJM0335C1E8R5CB01#			9.9pF	±0.05pF	GJM0335C1E9R9WB01#
			±0.5pF	GJM0335C1E8R5DB01#				±0.1pF	GJM0335C1E9R9BB01#
		8.6pF	±0.05pF	GJM0335C1E8R6WB01#				±0.25pF	GJM0335C1E9R9CB01#
			±0.1pF	GJM0335C1E8R6BB01#				±0.5pF	GJM0335C1E9R9DB01#
			±0.25pF	GJM0335C1E8R6CB01#			10pF	±1%	GJM0335C1E100FB01#
			±0.5pF	GJM0335C1E8R6DB01#				±2%	GJM0335C1E100GB01#
		8.7pF	±0.05pF	GJM0335C1E8R7WB01#				±5%	GJM0335C1E100JB01#
			±0.1pF	GJM0335C1E8R7BB01#			11pF	±2%	GJM0335C1E110GB01#
			±0.25pF	GJM0335C1E8R7CB01#				±5%	GJM0335C1E110JB01#
			±0.5pF	GJM0335C1E8R7DB01#				12pF	±1%
		8.8pF	±0.05pF	GJM0335C1E8R8WB01#			±2%		GJM0335C1E120GB01#
			±0.1pF	GJM0335C1E8R8BB01#			±5%		GJM0335C1E120JB01#
			±0.25pF	GJM0335C1E8R8CB01#			13pF	±2%	GJM0335C1E130GB01#
			±0.5pF	GJM0335C1E8R8DB01#				±5%	GJM0335C1E130JB01#
		8.9pF	±0.05pF	GJM0335C1E8R9WB01#				15pF	±1%
			±0.1pF	GJM0335C1E8R9BB01#			±2%		GJM0335C1E150GB01#
			±0.25pF	GJM0335C1E8R9CB01#			±5%		GJM0335C1E150JB01#
			±0.5pF	GJM0335C1E8R9DB01#			16pF	±2%	GJM0335C1E160GB01#
		9.0pF	±0.05pF	GJM0335C1E9R0WB01#				±5%	GJM0335C1E160JB01#
			±0.1pF	GJM0335C1E9R0BB01#				18pF	±1%
			±0.25pF	GJM0335C1E9R0CB01#			±2%		GJM0335C1E180GB01#
			±0.5pF	GJM0335C1E9R0DB01#			±5%		GJM0335C1E180JB01#
		9.1pF	±0.05pF	GJM0335C1E9R1WB01#			20pF	±1%	GJM0335C1E200FB01#
			±0.1pF	GJM0335C1E9R1BB01#				±2%	GJM0335C1E200GB01#
			±0.25pF	GJM0335C1E9R1CB01#				±5%	GJM0335C1E200JB01#
			±0.5pF	GJM0335C1E9R1DB01#			22pF	±2%	GJM0335C1E220GB01#
		9.2pF	±0.05pF	GJM0335C1E9R2WB01#				±5%	GJM0335C1E220JB01#
			±0.1pF	GJM0335C1E9R2BB01#				24pF	±2%
			±0.25pF	GJM0335C1E9R2CB01#			±5%		GJM0335C1E240JB01#
			±0.5pF	GJM0335C1E9R2DB01#			27pF		±2%
		9.3pF	±0.05pF	GJM0335C1E9R3WB01#				±5%	GJM0335C1E270JB01#
			±0.1pF	GJM0335C1E9R3BB01#			30pF	±2%	GJM0335C1E300GB01#
			±0.25pF	GJM0335C1E9R3CB01#				±5%	GJM0335C1E300JB01#
			±0.5pF	GJM0335C1E9R3DB01#				33pF	±2%
		9.4pF	±0.05pF	GJM0335C1E9R4WB01#			±5%		GJM0335C1E330JB01#
			±0.1pF	GJM0335C1E9R4BB01#			4.0pF		±0.05pF
±0.25pF	GJM0335C1E9R4CB01#		±0.1pF	GJM0332C1E4R0BB01#					
±0.5pF	GJM0335C1E9R4DB01#		±0.25pF	GJM0332C1E4R0CB01#					
9.5pF	±0.05pF	GJM0335C1E9R5WB01#	4.1pF	±0.05pF	GJM0332C1E4R1WB01#				
	±0.1pF	GJM0335C1E9R5BB01#		±0.1pF	GJM0332C1E4R1BB01#				
	±0.25pF	GJM0335C1E9R5CB01#		±0.25pF	GJM0332C1E4R1CB01#				
	±0.5pF	GJM0335C1E9R5DB01#	4.2pF	±0.05pF	GJM0332C1E4R2WB01#				

Part number # indicates the package specification code.

- GRM
- GR3
- GRJ
- GR4
- GJM
- GQM
- GGA2
- GGA3 GB
- GGA3 GD
- GGA3 GF
- LLL
- LLA
- LLM
- LLR
- NFM
- GJ4
- ZRA
- ZRB
- KRM
- KR3
- GMA
- GMD
- ⚠Caution /Notice

GJM Series Temperature Compensating Type High Q Part Number List

(→ 0.6×0.3mm)

Rated Voltage	TC Code	Cap.	Tol.	Part Number	Rated Voltage	TC Code	Cap.	Tol.	Part Number				
25Vdc	CH	4.2pF	±0.1pF	GJM0332C1E4R2BB01#	25Vdc	CH	5.8pF	±0.05pF	GJM0332C1E5R8WB01#				
			±0.25pF	GJM0332C1E4R2CB01#				±0.1pF	GJM0332C1E5R8BB01#				
		4.3pF	±0.05pF	GJM0332C1E4R3WB01#			±0.25pF	GJM0332C1E5R8CB01#					
			±0.1pF	GJM0332C1E4R3BB01#			±0.5pF	GJM0332C1E5R8DB01#					
			±0.25pF	GJM0332C1E4R3CB01#			5.9pF	±0.05pF	GJM0332C1E5R9WB01#				
		4.4pF	±0.05pF	GJM0332C1E4R4WB01#				±0.1pF	GJM0332C1E5R9BB01#				
			±0.1pF	GJM0332C1E4R4BB01#				±0.25pF	GJM0332C1E5R9CB01#				
			±0.25pF	GJM0332C1E4R4CB01#			±0.5pF	GJM0332C1E5R9DB01#					
		4.5pF	±0.05pF	GJM0332C1E4R5WB01#			6.0pF	±0.05pF	GJM0332C1E6R0WB01#				
			±0.1pF	GJM0332C1E4R5BB01#				±0.1pF	GJM0332C1E6R0BB01#				
			±0.25pF	GJM0332C1E4R5CB01#				±0.25pF	GJM0332C1E6R0CB01#				
		4.6pF	±0.05pF	GJM0332C1E4R6WB01#			6.1pF	±0.05pF	GJM0332C1E6R1WB01#				
			±0.1pF	GJM0332C1E4R6BB01#				±0.1pF	GJM0332C1E6R1BB01#				
			±0.25pF	GJM0332C1E4R6CB01#				±0.25pF	GJM0332C1E6R1CB01#				
		4.7pF	±0.05pF	GJM0332C1E4R7WB01#			6.2pF	±0.05pF	GJM0332C1E6R2WB01#				
			±0.1pF	GJM0332C1E4R7BB01#				±0.1pF	GJM0332C1E6R2BB01#				
			±0.25pF	GJM0332C1E4R7CB01#				±0.25pF	GJM0332C1E6R2CB01#				
		4.8pF	±0.05pF	GJM0332C1E4R8WB01#			6.3pF	±0.05pF	GJM0332C1E6R3WB01#				
			±0.1pF	GJM0332C1E4R8BB01#				±0.1pF	GJM0332C1E6R3BB01#				
			±0.25pF	GJM0332C1E4R8CB01#				±0.25pF	GJM0332C1E6R3CB01#				
		4.9pF	±0.05pF	GJM0332C1E4R9WB01#			6.4pF	±0.05pF	GJM0332C1E6R4WB01#				
			±0.1pF	GJM0332C1E4R9BB01#				±0.1pF	GJM0332C1E6R4BB01#				
			±0.25pF	GJM0332C1E4R9CB01#				±0.25pF	GJM0332C1E6R4CB01#				
		5.0pF	±0.05pF	GJM0332C1E5R0WB01#			6.5pF	±0.05pF	GJM0332C1E6R5WB01#				
			±0.1pF	GJM0332C1E5R0BB01#				±0.1pF	GJM0332C1E6R5BB01#				
			±0.25pF	GJM0332C1E5R0CB01#				±0.25pF	GJM0332C1E6R5CB01#				
		5.1pF	±0.05pF	GJM0332C1E5R1WB01#			6.6pF	±0.05pF	GJM0332C1E6R6WB01#				
			±0.1pF	GJM0332C1E5R1BB01#				±0.1pF	GJM0332C1E6R6BB01#				
			±0.25pF	GJM0332C1E5R1CB01#				±0.25pF	GJM0332C1E6R6CB01#				
		5.2pF	±0.05pF	GJM0332C1E5R2WB01#			6.7pF	±0.05pF	GJM0332C1E6R7WB01#				
			±0.1pF	GJM0332C1E5R2BB01#				±0.1pF	GJM0332C1E6R7BB01#				
			±0.25pF	GJM0332C1E5R2CB01#				±0.25pF	GJM0332C1E6R7CB01#				
		5.3pF	±0.05pF	GJM0332C1E5R3WB01#			6.8pF	±0.05pF	GJM0332C1E6R8WB01#				
			±0.1pF	GJM0332C1E5R3BB01#				±0.1pF	GJM0332C1E6R8BB01#				
			±0.25pF	GJM0332C1E5R3CB01#				±0.25pF	GJM0332C1E6R8CB01#				
		5.4pF	±0.05pF	GJM0332C1E5R4WB01#			6.9pF	±0.05pF	GJM0332C1E6R9WB01#				
			±0.1pF	GJM0332C1E5R4BB01#				±0.1pF	GJM0332C1E6R9BB01#				
			±0.25pF	GJM0332C1E5R4CB01#				±0.25pF	GJM0332C1E6R9CB01#				
		5.5pF	±0.05pF	GJM0332C1E5R5WB01#			7.0pF	±0.05pF	GJM0332C1E7R0WB01#				
			±0.1pF	GJM0332C1E5R5BB01#				±0.1pF	GJM0332C1E7R0BB01#				
			±0.25pF	GJM0332C1E5R5CB01#				±0.25pF	GJM0332C1E7R0CB01#				
		5.6pF	±0.05pF	GJM0332C1E5R6WB01#			7.1pF	±0.05pF	GJM0332C1E7R1WB01#				
			±0.1pF	GJM0332C1E5R6BB01#				±0.1pF	GJM0332C1E7R1BB01#				
			±0.25pF	GJM0332C1E5R6CB01#				±0.25pF	GJM0332C1E7R1CB01#				
		5.7pF	±0.05pF	GJM0332C1E5R7WB01#									
			±0.1pF	GJM0332C1E5R7BB01#									
			±0.25pF	GJM0332C1E5R7CB01#									
				±0.5pF			GJM0332C1E5R7DB01#						

- GRM
- GR3
- GRJ
- GR4
- GJM
- GQM
- GGA2
- GGA3 GB
- GGA3 GD
- GGA3 GF
- LLL
- LLA
- LLM
- LLR
- NFM
- GJ4
- ZRA
- ZRB
- KRM
- KR3
- GMA
- GMD
- ⚠Caution /Notice

Part number # indicates the package specification code.

GJM Series Temperature Compensating Type High Q Part Number List

(→ 0.6×0.3mm)

Rated Voltage	TC Code	Cap.	Tol.	Part Number	Rated Voltage	TC Code	Cap.	Tol.	Part Number
25Vdc	CH	7.1pF	±0.25pF	GJM0332C1E7R1CB01#	25Vdc	CH	8.5pF	±0.05pF	GJM0332C1E8R5WB01#
			±0.5pF	GJM0332C1E7R1DB01#				±0.1pF	GJM0332C1E8R5BB01#
		7.2pF	±0.05pF	GJM0332C1E7R2WB01#			±0.25pF	GJM0332C1E8R5CB01#	
			±0.1pF	GJM0332C1E7R2BB01#			±0.5pF	GJM0332C1E8R5DB01#	
			±0.25pF	GJM0332C1E7R2CB01#			8.6pF	±0.05pF	GJM0332C1E8R6WB01#
			±0.5pF	GJM0332C1E7R2DB01#				±0.1pF	GJM0332C1E8R6BB01#
		7.3pF	±0.05pF	GJM0332C1E7R3WB01#			±0.25pF	GJM0332C1E8R6CB01#	
			±0.1pF	GJM0332C1E7R3BB01#			±0.5pF	GJM0332C1E8R6DB01#	
			±0.25pF	GJM0332C1E7R3CB01#			8.7pF	±0.05pF	GJM0332C1E8R7WB01#
			±0.5pF	GJM0332C1E7R3DB01#				±0.1pF	GJM0332C1E8R7BB01#
		7.4pF	±0.05pF	GJM0332C1E7R4WB01#			±0.25pF	GJM0332C1E8R7CB01#	
			±0.1pF	GJM0332C1E7R4BB01#			±0.5pF	GJM0332C1E8R7DB01#	
			±0.25pF	GJM0332C1E7R4CB01#			8.8pF	±0.05pF	GJM0332C1E8R8WB01#
			±0.5pF	GJM0332C1E7R4DB01#				±0.1pF	GJM0332C1E8R8BB01#
		7.5pF	±0.05pF	GJM0332C1E7R5WB01#			±0.25pF	GJM0332C1E8R8CB01#	
			±0.1pF	GJM0332C1E7R5BB01#			±0.5pF	GJM0332C1E8R8DB01#	
			±0.25pF	GJM0332C1E7R5CB01#			8.9pF	±0.05pF	GJM0332C1E8R9WB01#
			±0.5pF	GJM0332C1E7R5DB01#				±0.1pF	GJM0332C1E8R9BB01#
		7.6pF	±0.05pF	GJM0332C1E7R6WB01#			±0.25pF	GJM0332C1E8R9CB01#	
			±0.1pF	GJM0332C1E7R6BB01#			±0.5pF	GJM0332C1E8R9DB01#	
			±0.25pF	GJM0332C1E7R6CB01#			9.0pF	±0.05pF	GJM0332C1E9R0WB01#
			±0.5pF	GJM0332C1E7R6DB01#				±0.1pF	GJM0332C1E9R0BB01#
		7.7pF	±0.05pF	GJM0332C1E7R7WB01#			±0.25pF	GJM0332C1E9R0CB01#	
			±0.1pF	GJM0332C1E7R7BB01#			±0.5pF	GJM0332C1E9R0DB01#	
			±0.25pF	GJM0332C1E7R7CB01#			9.1pF	±0.05pF	GJM0332C1E9R1WB01#
			±0.5pF	GJM0332C1E7R7DB01#				±0.1pF	GJM0332C1E9R1BB01#
		7.8pF	±0.05pF	GJM0332C1E7R8WB01#			±0.25pF	GJM0332C1E9R1CB01#	
			±0.1pF	GJM0332C1E7R8BB01#			±0.5pF	GJM0332C1E9R1DB01#	
			±0.25pF	GJM0332C1E7R8CB01#			9.2pF	±0.05pF	GJM0332C1E9R2WB01#
			±0.5pF	GJM0332C1E7R8DB01#				±0.1pF	GJM0332C1E9R2BB01#
		7.9pF	±0.05pF	GJM0332C1E7R9WB01#			±0.25pF	GJM0332C1E9R2CB01#	
			±0.1pF	GJM0332C1E7R9BB01#			±0.5pF	GJM0332C1E9R2DB01#	
			±0.25pF	GJM0332C1E7R9CB01#			9.3pF	±0.05pF	GJM0332C1E9R3WB01#
			±0.5pF	GJM0332C1E7R9DB01#				±0.1pF	GJM0332C1E9R3BB01#
		8.0pF	±0.05pF	GJM0332C1E8R0WB01#			±0.25pF	GJM0332C1E9R3CB01#	
			±0.1pF	GJM0332C1E8R0BB01#			±0.5pF	GJM0332C1E9R3DB01#	
			±0.25pF	GJM0332C1E8R0CB01#			9.4pF	±0.05pF	GJM0332C1E9R4WB01#
			±0.5pF	GJM0332C1E8R0DB01#				±0.1pF	GJM0332C1E9R4BB01#
		8.1pF	±0.05pF	GJM0332C1E8R1WB01#			±0.25pF	GJM0332C1E9R4CB01#	
			±0.1pF	GJM0332C1E8R1BB01#			±0.5pF	GJM0332C1E9R4DB01#	
			±0.25pF	GJM0332C1E8R1CB01#			9.5pF	±0.05pF	GJM0332C1E9R5WB01#
			±0.5pF	GJM0332C1E8R1DB01#				±0.1pF	GJM0332C1E9R5BB01#
		8.2pF	±0.05pF	GJM0332C1E8R2WB01#			±0.25pF	GJM0332C1E9R5CB01#	
			±0.1pF	GJM0332C1E8R2BB01#			±0.5pF	GJM0332C1E9R5DB01#	
			±0.25pF	GJM0332C1E8R2CB01#			9.6pF	±0.05pF	GJM0332C1E9R6WB01#
			±0.5pF	GJM0332C1E8R2DB01#				±0.1pF	GJM0332C1E9R6BB01#
		8.3pF	±0.05pF	GJM0332C1E8R3WB01#			±0.25pF	GJM0332C1E9R6CB01#	
			±0.1pF	GJM0332C1E8R3BB01#			±0.5pF	GJM0332C1E9R6DB01#	
			±0.25pF	GJM0332C1E8R3CB01#			9.7pF	±0.05pF	GJM0332C1E9R7WB01#
			±0.5pF	GJM0332C1E8R3DB01#				±0.1pF	GJM0332C1E9R7BB01#
		8.4pF	±0.05pF	GJM0332C1E8R4WB01#			±0.25pF	GJM0332C1E9R7CB01#	
			±0.1pF	GJM0332C1E8R4BB01#			±0.5pF	GJM0332C1E9R7DB01#	
			±0.25pF	GJM0332C1E8R4CB01#			9.8pF	±0.05pF	GJM0332C1E9R8WB01#
			±0.5pF	GJM0332C1E8R4DB01#				±0.1pF	GJM0332C1E9R8BB01#

- GRM
- GR3
- GRJ
- GR4
- GJM
- GQM
- GQ2
- GA2
- GA3
- GA3
- GA3
- GA3
- LL
- LLA
- LLM
- LLR
- NFM
- GJ4
- ZRA
- ZRB
- KRM
- KR3
- GMA
- GMD
- ⚠Caution / Notice

Part number # indicates the package specification code.

GJM Series Temperature Compensating Type High Q Part Number List

(→ 0.6×0.3mm)

Rated Voltage	TC Code	Cap.	Tol.	Part Number		Rated Voltage	TC Code	Cap.	Tol.	Part Number					
25Vdc	CH	9.8pF	±0.25pF	GJM0332C1E9R8CB01#		25Vdc	CJ	2.8pF	±0.1pF	GJM0333C1E2R8BB01#					
			±0.5pF	GJM0332C1E9R8DB01#					±0.25pF	GJM0333C1E2R8CB01#					
		9.9pF	±0.05pF	GJM0332C1E9R9WB01#				2.9pF	±0.05pF	GJM0333C1E2R9WB01#					
			±0.1pF	GJM0332C1E9R9BB01#					±0.1pF	GJM0333C1E2R9BB01#					
			±0.25pF	GJM0332C1E9R9CB01#					±0.25pF	GJM0333C1E2R9CB01#					
			±0.5pF	GJM0332C1E9R9DB01#					3.0pF	±0.05pF	GJM0333C1E3R0WB01#				
		±2%	GJM0332C1E100GB01#		±0.1pF			GJM0333C1E3R0BB01#							
		±5%	GJM0332C1E100JB01#		±0.25pF			GJM0333C1E3R0CB01#							
		11pF	±2%	GJM0332C1E110GB01#				3.1pF	±0.05pF	GJM0333C1E3R1WB01#					
			±5%	GJM0332C1E110JB01#					±0.1pF	GJM0333C1E3R1BB01#					
		12pF	±2%	GJM0332C1E120GB01#				3.2pF	±0.05pF	GJM0333C1E3R2WB01#					
			±5%	GJM0332C1E120JB01#					±0.1pF	GJM0333C1E3R2BB01#					
		13pF	±2%	GJM0332C1E130GB01#				3.3pF	±0.05pF	GJM0333C1E3R3WB01#					
			±5%	GJM0332C1E130JB01#					±0.1pF	GJM0333C1E3R3BB01#					
		15pF	±2%	GJM0332C1E150GB01#				3.4pF	±0.05pF	GJM0333C1E3R4WB01#					
			±5%	GJM0332C1E150JB01#					±0.1pF	GJM0333C1E3R4BB01#					
		16pF	±2%	GJM0332C1E160GB01#				3.5pF	±0.05pF	GJM0333C1E3R5WB01#					
			±5%	GJM0332C1E160JB01#					±0.1pF	GJM0333C1E3R5BB01#					
		18pF	±2%	GJM0332C1E180GB01#				3.6pF	±0.05pF	GJM0333C1E3R6WB01#					
			±5%	GJM0332C1E180JB01#					±0.1pF	GJM0333C1E3R6BB01#					
		20pF	±2%	GJM0332C1E200GB01#				3.7pF	±0.05pF	GJM0333C1E3R7WB01#					
			±5%	GJM0332C1E200JB01#					±0.1pF	GJM0333C1E3R7BB01#					
		22pF	±2%	GJM0332C1E220GB01#				3.8pF	±0.05pF	GJM0333C1E3R8WB01#					
			±5%	GJM0332C1E220JB01#					±0.1pF	GJM0333C1E3R8BB01#					
		24pF	±2%	GJM0332C1E240GB01#				3.9pF	±0.05pF	GJM0333C1E3R9WB01#					
			±5%	GJM0332C1E240JB01#					±0.1pF	GJM0333C1E3R9BB01#					
		27pF	±2%	GJM0332C1E270GB01#				0.20pF	±0.05pF	GJM0334C1ER20WB01#					
			±5%	GJM0332C1E270JB01#					±0.1pF	GJM0334C1ER20BB01#					
		30pF	±2%	GJM0332C1E300GB01#				0.30pF	±0.05pF	GJM0334C1ER30WB01#					
			±5%	GJM0332C1E300JB01#					±0.1pF	GJM0334C1ER30BB01#					
		33pF	±2%	GJM0332C1E330GB01#				0.40pF	±0.05pF	GJM0334C1ER40WB01#					
			±5%	GJM0332C1E330JB01#					±0.1pF	GJM0334C1ER40BB01#					
		25Vdc	CJ	2.1pF	±0.05pF			GJM0333C1E2R1WB01#		25Vdc	CK	0.20pF	±0.05pF	GJM0334C1ER20WB01#	
					±0.1pF			GJM0333C1E2R1BB01#					±0.1pF	GJM0334C1ER20BB01#	
					±0.25pF			GJM0333C1E2R1CB01#					0.30pF	±0.05pF	GJM0334C1ER30WB01#
				±0.05pF	GJM0333C1E2R2WB01#				±0.1pF			GJM0334C1ER30BB01#			
				2.2pF	±0.1pF			GJM0333C1E2R2BB01#				0.40pF	±0.05pF	GJM0334C1ER40WB01#	
					±0.25pF			GJM0333C1E2R2CB01#					±0.1pF	GJM0334C1ER40BB01#	
					±0.05pF			GJM0333C1E2R3WB01#					0.50pF	±0.05pF	GJM0334C1ER50WB01#
				±0.1pF	GJM0333C1E2R3BB01#				±0.1pF			GJM0334C1ER50BB01#			
				2.3pF	±0.25pF			GJM0333C1E2R3CB01#				0.60pF	±0.05pF	GJM0334C1ER60WB01#	
					±0.05pF			GJM0333C1E2R4WB01#					±0.1pF	GJM0334C1ER60BB01#	
					±0.1pF			GJM0333C1E2R4BB01#					0.70pF	±0.05pF	GJM0334C1ER70WB01#
				±0.25pF	GJM0333C1E2R4CB01#				±0.1pF			GJM0334C1ER70BB01#			
				2.4pF	±0.05pF			GJM0333C1E2R5WB01#				0.80pF	±0.05pF	GJM0334C1ER80WB01#	
					±0.1pF			GJM0333C1E2R5BB01#					±0.1pF	GJM0334C1ER80BB01#	
					±0.25pF			GJM0333C1E2R5CB01#					0.90pF	±0.05pF	GJM0334C1ER90WB01#
				±0.05pF	GJM0333C1E2R6WB01#				±0.1pF			GJM0334C1ER90BB01#			
2.5pF	±0.1pF			GJM0333C1E2R6BB01#		1.0pF	±0.05pF	GJM0334C1E1R0WB01#							
	±0.25pF			GJM0333C1E2R6CB01#			±0.1pF	GJM0334C1E1R0BB01#							
	±0.05pF			GJM0333C1E2R7WB01#			±0.25pF	GJM0334C1E1R0CB01#							
2.6pF	±0.1pF			GJM0333C1E2R7BB01#											
	±0.25pF			GJM0333C1E2R7CB01#											
	±0.05pF			GJM0333C1E2R8WB01#											

Part number # indicates the package specification code.

GRM
 GR3
 GRJ
 GR4
 GJM
 GQM
 GA2
 GA3 GB
 GA3 GD
 GA3 GF
 LLL
 LLA
 LLM
 LLR
 NFM
 GJ4
 ZRA
 ZRB
 KRM
 KR3
 GMA
 GMD
 ⚠Caution /Notice

GJM Series Temperature Compensating Type **High Q** Part Number List

(→ 0.6×0.3mm)

Rated Voltage	TC Code	Cap.	Tol.	Part Number			
25Vdc	CK	1.1pF	±0.05pF	GJM0334C1E1R1WB01#			
			±0.1pF	GJM0334C1E1R1BB01#			
			±0.25pF	GJM0334C1E1R1CB01#			
		1.2pF	±0.05pF	GJM0334C1E1R2WB01#			
			±0.1pF	GJM0334C1E1R2BB01#			
			±0.25pF	GJM0334C1E1R2CB01#			
			1.3pF	±0.05pF	GJM0334C1E1R3WB01#		
		±0.1pF		GJM0334C1E1R3BB01#			
		±0.25pF		GJM0334C1E1R3CB01#			
		1.4pF	±0.05pF	GJM0334C1E1R4WB01#			
			±0.1pF	GJM0334C1E1R4BB01#			
			±0.25pF	GJM0334C1E1R4CB01#			
		1.5pF	±0.05pF	GJM0334C1E1R5WB01#			
			±0.1pF	GJM0334C1E1R5BB01#			
			±0.25pF	GJM0334C1E1R5CB01#			
		1.6pF	±0.05pF	GJM0334C1E1R6WB01#			
			±0.1pF	GJM0334C1E1R6BB01#			
			±0.25pF	GJM0334C1E1R6CB01#			
		1.7pF	±0.05pF	GJM0334C1E1R7WB01#			
			±0.1pF	GJM0334C1E1R7BB01#			
			±0.25pF	GJM0334C1E1R7CB01#			
		1.8pF	±0.05pF	GJM0334C1E1R8WB01#			
			±0.1pF	GJM0334C1E1R8BB01#			
			±0.25pF	GJM0334C1E1R8CB01#			
		1.9pF	±0.05pF	GJM0334C1E1R9WB01#			
			±0.1pF	GJM0334C1E1R9BB01#			
			±0.25pF	GJM0334C1E1R9CB01#			
		2.0pF	±0.05pF	GJM0334C1E2R0WB01#			
			±0.1pF	GJM0334C1E2R0BB01#			
			±0.25pF	GJM0334C1E2R0CB01#			
		6.3Vdc	COG	22pF	±2%	GJM0335C0J220GB01#	
					±5%	GJM0335C0J220JB01#	
					24pF	±2%	GJM0335C0J240GB01#
				±5%		GJM0335C0J240JB01#	
				27pF	±2%	GJM0335C0J270GB01#	
					±5%	GJM0335C0J270JB01#	
				30pF	±2%	GJM0335C0J300GB01#	
					±5%	GJM0335C0J300JB01#	
				33pF	±2%	GJM0335C0J330GB01#	
					±5%	GJM0335C0J330JB01#	
				CH	22pF	±2%	GJM0332C0J220GB01#
						±5%	GJM0332C0J220JB01#
					24pF	±2%	GJM0332C0J240GB01#
						±5%	GJM0332C0J240JB01#
					27pF	±2%	GJM0332C0J270GB01#
						±5%	GJM0332C0J270JB01#
					30pF	±2%	GJM0332C0J300GB01#
						±5%	GJM0332C0J300JB01#
33pF	±2%				GJM0332C0J330GB01#		
	±5%				GJM0332C0J330JB01#		

1.0×0.5mm

Rated Voltage	TC Code	Cap.	Tol.	Part Number
50Vdc	COG	0.10pF	±0.05pF	GJM1555C1HR10WB01#
			±0.1pF	GJM1555C1HR10BB01#
			±20%	GJM1555C1HR10MB01#
		0.11pF	±0.05pF	GJM1555C1HR11WB01#
			±0.1pF	GJM1555C1HR11BB01#
		0.12pF	±0.05pF	GJM1555C1HR12WB01#
			±0.1pF	GJM1555C1HR12BB01#
		0.13pF	±0.05pF	GJM1555C1HR13WB01#
			±0.1pF	GJM1555C1HR13BB01#
		0.15pF	±0.03pF	GJM1555C1HR15RB12#
			±0.05pF	GJM1555C1HR15WB01#
			±0.1pF	GJM1555C1HR15BB01#
		0.16pF	±0.05pF	GJM1555C1HR16WB01#
			±0.1pF	GJM1555C1HR16BB01#
		0.18pF	±0.05pF	GJM1555C1HR18WB01#
			±0.1pF	GJM1555C1HR18BB01#
		0.20pF	±0.05pF	GJM1555C1HR20WB01#
			±0.1pF	GJM1555C1HR20BB01#
		0.22pF	±0.05pF	GJM1555C1HR22WB01#
			±0.1pF	GJM1555C1HR22BB01#
		0.24pF	±0.05pF	GJM1555C1HR24WB01#
			±0.1pF	GJM1555C1HR24BB01#
		0.25pF	±0.03pF	GJM1555C1HR25RB12#
			±0.1pF	GJM1555C1HR25BB01#
		0.27pF	±0.05pF	GJM1555C1HR27WB01#
			±0.1pF	GJM1555C1HR27BB01#
			±0.25pF	GJM1555C1HR27CB01#
		0.30pF	±0.05pF	GJM1555C1HR30WB01#
			±0.1pF	GJM1555C1HR30BB01#
			±0.25pF	GJM1555C1HR30CB01#
		0.33pF	±0.05pF	GJM1555C1HR33WB01#
			±0.1pF	GJM1555C1HR33BB01#
			±0.25pF	GJM1555C1HR33CB01#
		0.36pF	±0.05pF	GJM1555C1HR36WB01#
			±0.1pF	GJM1555C1HR36BB01#
			±0.25pF	GJM1555C1HR36CB01#
		0.39pF	±0.05pF	GJM1555C1HR39WB01#
			±0.1pF	GJM1555C1HR39BB01#
			±0.25pF	GJM1555C1HR39CB01#
		0.40pF	±0.05pF	GJM1555C1HR40WB01#
			±0.1pF	GJM1555C1HR40BB01#
			±0.25pF	GJM1555C1HR40CB01#
		0.43pF	±0.05pF	GJM1555C1HR43WB01#
			±0.1pF	GJM1555C1HR43BB01#
			±0.25pF	GJM1555C1HR43CB01#
		0.45pF	±0.03pF	GJM1555C1HR45RB12#
			±0.05pF	GJM1555C1HR45WB01#
		0.47pF	±0.05pF	GJM1555C1HR47WB01#
			±0.1pF	GJM1555C1HR47BB01#
			±0.25pF	GJM1555C1HR47CB01#
		0.50pF	±0.03pF	GJM1555C1HR50RB12#
			±0.05pF	GJM1555C1HR50WB01#

Part number # indicates the package specification code.

GJM Series Temperature Compensating Type High Q Part Number List

(→ 1.0×0.5mm)

Rated Voltage	TC Code	Cap.	Tol.	Part Number	Rated Voltage	TC Code	Cap.	Tol.	Part Number	
50Vdc	COG	0.50pF	±0.1pF	GJM1555C1HR50BB01#	50Vdc	COG	1.1pF	±0.05pF	GJM1555C1H1R1WB01#	
			±0.25pF	GJM1555C1HR50CB01#				±0.1pF	GJM1555C1H1R1BB01#	
			±0.5pF	GJM1555C1HR50DB01#				±0.25pF	GJM1555C1H1R1CB01#	
		0.51pF	±0.05pF	GJM1555C1HR51WB01#				±0.5pF	GJM1555C1H1R1DB01#	
			±0.1pF	GJM1555C1HR51BB01#				±5%	GJM1555C1H1R1JB01#	
			±0.25pF	GJM1555C1HR51CB01#				1.2pF	±0.05pF	GJM1555C1H1R2WB01#
		±0.5pF	GJM1555C1HR51DB01#	±0.1pF					GJM1555C1H1R2BB01#	
		0.56pF	±0.05pF	GJM1555C1HR56WB01#					±0.25pF	GJM1555C1H1R2CB01#
			±0.1pF	GJM1555C1HR56BB01#				±0.5pF	GJM1555C1H1R2DB01#	
			±0.25pF	GJM1555C1HR56CB01#				±5%	GJM1555C1H1R2JB01#	
		0.56pF	±0.5pF	GJM1555C1HR56DB01#				1.3pF	±0.05pF	GJM1555C1H1R3WB01#
			0.60pF	±0.05pF					GJM1555C1HR60WB01#	±0.1pF
				±0.1pF			GJM1555C1HR60BB01#		±0.25pF	GJM1555C1H1R3CB01#
		±0.25pF		GJM1555C1HR60CB01#			±0.5pF	GJM1555C1H1R3DB01#		
		0.60pF	±0.5pF	GJM1555C1HR60DB01#			±5%	GJM1555C1H1R3JB01#		
			0.62pF	±0.05pF			GJM1555C1HR62WB01#	1.4pF	±0.05pF	GJM1555C1H1R4WB01#
				±0.1pF			GJM1555C1HR62BB01#		±0.1pF	GJM1555C1H1R4BB01#
		±0.25pF		GJM1555C1HR62CB01#			±0.25pF		GJM1555C1H1R4CB01#	
		0.62pF	±0.5pF	GJM1555C1HR62DB01#			±0.5pF	GJM1555C1H1R4DB01#		
			0.68pF	±0.05pF			GJM1555C1HR68WB01#	±5%	GJM1555C1H1R4JB01#	
				±0.1pF			GJM1555C1HR68BB01#	1.5pF	±0.05pF	GJM1555C1H1R5WB01#
		±0.25pF		GJM1555C1HR68CB01#			±0.1pF		GJM1555C1H1R5BB01#	
		±0.5pF	GJM1555C1HR68DB01#	±0.25pF			GJM1555C1H1R5CB01#			
		0.70pF	±0.05pF	GJM1555C1HR70WB01#			±0.5pF	GJM1555C1H1R5DB01#		
			±0.1pF	GJM1555C1HR70BB01#			±5%	GJM1555C1H1R5JB01#		
			±0.25pF	GJM1555C1HR70CB01#			1.6pF	±0.05pF	GJM1555C1H1R6WB01#	
		±0.5pF	GJM1555C1HR70DB01#	±0.1pF				GJM1555C1H1R6BB01#		
		0.75pF	±0.05pF	GJM1555C1HR75WB01#				±0.25pF	GJM1555C1H1R6CB01#	
			±0.1pF	GJM1555C1HR75BB01#			±0.5pF	GJM1555C1H1R6DB01#		
			±0.25pF	GJM1555C1HR75CB01#			±5%	GJM1555C1H1R6JB01#		
		0.75pF	±0.5pF	GJM1555C1HR75DB01#			1.7pF	±0.05pF	GJM1555C1H1R7WB01#	
			0.80pF	±0.05pF				GJM1555C1HR80WB01#	±0.1pF	GJM1555C1H1R7BB01#
				±0.1pF				GJM1555C1HR80BB01#	±0.25pF	GJM1555C1H1R7CB01#
		±0.25pF		GJM1555C1HR80CB01#			±0.5pF	GJM1555C1H1R7DB01#		
		0.80pF	±0.5pF	GJM1555C1HR80DB01#			±5%	GJM1555C1H1R7JB01#		
			0.82pF	±0.05pF			GJM1555C1HR82WB01#	1.8pF	±0.05pF	GJM1555C1H1R8WB01#
				±0.1pF			GJM1555C1HR82BB01#		±0.1pF	GJM1555C1H1R8BB01#
		±0.25pF		GJM1555C1HR82CB01#			±0.25pF		GJM1555C1H1R8CB01#	
		0.82pF	±0.5pF	GJM1555C1HR82DB01#			±0.5pF	GJM1555C1H1R8DB01#		
			0.85pF	±0.05pF			GJM1555C1HR85WB01#	±5%	GJM1555C1H1R8JB01#	
				0.90pF			±0.05pF	GJM1555C1HR90WB01#	1.9pF	±0.05pF
		±0.1pF					GJM1555C1HR90BB01#	±0.1pF		GJM1555C1H1R9BB01#
		±0.25pF	GJM1555C1HR90CB01#				±0.25pF	GJM1555C1H1R9CB01#		
		0.90pF	±0.5pF	GJM1555C1HR90DB01#			±0.5pF	GJM1555C1H1R9DB01#		
			0.91pF	±0.05pF			GJM1555C1HR91WB01#	±5%	GJM1555C1H1R9JB01#	
				±0.1pF			GJM1555C1HR91BB01#	2.0pF	±0.05pF	GJM1555C1H2R0WB01#
		±0.25pF		GJM1555C1HR91CB01#			±0.1pF		GJM1555C1H2R0BB01#	
		±0.5pF	GJM1555C1HR91DB01#	±0.25pF			GJM1555C1H2R0CB01#			
		0.95pF	±0.05pF	GJM1555C1HR95WB01#			±0.5pF	GJM1555C1H2R0DB01#		
			1.0pF	±0.05pF			GJM1555C1H1R0WB01#	±2%	GJM1555C1H2R0GB01#	
				±0.1pF			GJM1555C1H1R0BB01#	2.1pF	±0.05pF	GJM1555C1H2R1WB01#
		±0.25pF		GJM1555C1H1R0CB01#			±0.1pF		GJM1555C1H2R1BB01#	
		±0.5pF	GJM1555C1H1R0DB01#	±0.25pF			GJM1555C1H2R1CB01#			
		±5%	GJM1555C1H1R0JB01#	±0.5pF			GJM1555C1H2R1DB01#			

Part number # indicates the package specification code.

- GRM
- GR3
- GRJ
- GR4
- GJM
- GQM
- GAG
- GA2
- GA3
- GA3
- GA3
- GA3
- LLL
- LLA
- LLM
- LLR
- NFM
- GJ4
- ZRA
- ZRB
- KRM
- KR3
- GMA
- GMD
- ⚠Caution /Notice

GJM Series Temperature Compensating Type High Q Part Number List

(→ 1.0×0.5mm)

Rated Voltage	TC Code	Cap.	Tol.	Part Number	Rated Voltage	TC Code	Cap.	Tol.	Part Number	
50Vdc	COG	2.1pF	±2%	GJM1555C1H2R1GB01#	50Vdc	COG	3.2pF	±0.5pF	GJM1555C1H3R2DB01#	
			±0.05pF	GJM1555C1H2R2WB01#				±2%	GJM1555C1H3R2GB01#	
			±0.1pF	GJM1555C1H2R2BB01#				3.3pF	±0.05pF	GJM1555C1H3R3WB01#
			±0.25pF	GJM1555C1H2R2CB01#					±0.1pF	GJM1555C1H3R3BB01#
			±0.5pF	GJM1555C1H2R2DB01#					±0.25pF	GJM1555C1H3R3CB01#
		±2%	GJM1555C1H2R2GB01#	±0.5pF			GJM1555C1H3R3DB01#			
				±2%			GJM1555C1H3R3GB01#			
		2.3pF	±0.05pF	GJM1555C1H2R3WB01#			3.4pF	±0.05pF	GJM1555C1H3R4WB01#	
			±0.1pF	GJM1555C1H2R3BB01#				±0.1pF	GJM1555C1H3R4BB01#	
			±0.25pF	GJM1555C1H2R3CB01#				±0.25pF	GJM1555C1H3R4CB01#	
			±0.5pF	GJM1555C1H2R3DB01#				±0.5pF	GJM1555C1H3R4DB01#	
			±2%	GJM1555C1H2R3GB01#				±2%	GJM1555C1H3R4GB01#	
		2.4pF	±0.05pF	GJM1555C1H2R4WB01#			3.5pF	±0.05pF	GJM1555C1H3R5WB01#	
			±0.1pF	GJM1555C1H2R4BB01#				±0.1pF	GJM1555C1H3R5BB01#	
			±0.25pF	GJM1555C1H2R4CB01#				±0.25pF	GJM1555C1H3R5CB01#	
			±0.5pF	GJM1555C1H2R4DB01#				±0.5pF	GJM1555C1H3R5DB01#	
			±2%	GJM1555C1H2R4GB01#				±2%	GJM1555C1H3R5GB01#	
		2.5pF	±0.05pF	GJM1555C1H2R5WB01#			3.6pF	±0.05pF	GJM1555C1H3R6WB01#	
			±0.1pF	GJM1555C1H2R5BB01#				±0.1pF	GJM1555C1H3R6BB01#	
			±0.25pF	GJM1555C1H2R5CB01#				±0.25pF	GJM1555C1H3R6CB01#	
			±0.5pF	GJM1555C1H2R5DB01#				±0.5pF	GJM1555C1H3R6DB01#	
			±2%	GJM1555C1H2R5GB01#				±2%	GJM1555C1H3R6GB01#	
		2.6pF	±0.05pF	GJM1555C1H2R6WB01#			3.7pF	±0.05pF	GJM1555C1H3R7WB01#	
			±0.1pF	GJM1555C1H2R6BB01#				±0.1pF	GJM1555C1H3R7BB01#	
			±0.25pF	GJM1555C1H2R6CB01#				±0.25pF	GJM1555C1H3R7CB01#	
			±0.5pF	GJM1555C1H2R6DB01#				±0.5pF	GJM1555C1H3R7DB01#	
			±2%	GJM1555C1H2R6GB01#				±2%	GJM1555C1H3R7GB01#	
		2.7pF	±0.05pF	GJM1555C1H2R7WB01#			3.8pF	±0.05pF	GJM1555C1H3R8WB01#	
			±0.1pF	GJM1555C1H2R7BB01#				±0.1pF	GJM1555C1H3R8BB01#	
			±0.25pF	GJM1555C1H2R7CB01#				±0.25pF	GJM1555C1H3R8CB01#	
			±0.5pF	GJM1555C1H2R7DB01#				±0.5pF	GJM1555C1H3R8DB01#	
			±2%	GJM1555C1H2R7GB01#				±2%	GJM1555C1H3R8GB01#	
		2.8pF	±0.05pF	GJM1555C1H2R8WB01#			3.9pF	±0.05pF	GJM1555C1H3R9WB01#	
			±0.1pF	GJM1555C1H2R8BB01#				±0.1pF	GJM1555C1H3R9BB01#	
			±0.25pF	GJM1555C1H2R8CB01#				±0.25pF	GJM1555C1H3R9CB01#	
			±0.5pF	GJM1555C1H2R8DB01#				±0.5pF	GJM1555C1H3R9DB01#	
			±2%	GJM1555C1H2R8GB01#				±2%	GJM1555C1H3R9GB01#	
		2.9pF	±0.05pF	GJM1555C1H2R9WB01#			4.0pF	±0.05pF	GJM1555C1H4R0WB01#	
			±0.1pF	GJM1555C1H2R9BB01#				±0.1pF	GJM1555C1H4R0BB01#	
			±0.25pF	GJM1555C1H2R9CB01#				±0.25pF	GJM1555C1H4R0CB01#	
			±0.5pF	GJM1555C1H2R9DB01#				±0.5pF	GJM1555C1H4R0DB01#	
			±2%	GJM1555C1H2R9GB01#				±2%	GJM1555C1H4R0GB01#	
		3.0pF	±0.05pF	GJM1555C1H3R0WB01#			4.1pF	±0.05pF	GJM1555C1H4R1WB01#	
			±0.1pF	GJM1555C1H3R0BB01#				±0.1pF	GJM1555C1H4R1BB01#	
			±0.25pF	GJM1555C1H3R0CB01#				±0.25pF	GJM1555C1H4R1CB01#	
			±0.5pF	GJM1555C1H3R0DB01#				±0.5pF	GJM1555C1H4R1DB01#	
			±2%	GJM1555C1H3R0GB01#				±2%	GJM1555C1H4R1GB01#	
		3.1pF	±0.05pF	GJM1555C1H3R1WB01#			4.2pF	±0.05pF	GJM1555C1H4R2WB01#	
			±0.1pF	GJM1555C1H3R1BB01#				±0.1pF	GJM1555C1H4R2BB01#	
			±0.25pF	GJM1555C1H3R1CB01#				±0.25pF	GJM1555C1H4R2CB01#	
			±0.5pF	GJM1555C1H3R1DB01#				±0.5pF	GJM1555C1H4R2DB01#	
			±2%	GJM1555C1H3R1GB01#				±2%	GJM1555C1H4R2GB01#	
3.2pF	±0.05pF	GJM1555C1H3R2WB01#	4.3pF	±0.05pF	GJM1555C1H4R3WB01#					
	±0.1pF	GJM1555C1H3R2BB01#		±0.1pF	GJM1555C1H4R3BB01#					
	±0.25pF	GJM1555C1H3R2CB01#								

- GRM
- GR3
- GRJ
- GR4
- GJM
- GQM
- GA2
- GA3 GB
- GA3 GD
- GA3 GF
- LLL
- LLA
- LLM
- LLR
- NFM
- GJ4
- ZRA
- ZRB
- KRM
- KR3
- GMA
- GMD
- ⚠Caution /Notice

Part number # indicates the package specification code.

GJM Series Temperature Compensating Type High Q Part Number List

(→ 1.0×0.5mm)

Rated Voltage	TC Code	Cap.	Tol.	Part Number	Rated Voltage	TC Code	Cap.	Tol.	Part Number
50Vdc	COG	4.3pF	±0.25pF	GJM1555C1H4R3CB01#	50Vdc	COG	5.4pF	±0.1pF	GJM1555C1H5R4BB01#
			±0.5pF	GJM1555C1H4R3DB01#				±0.25pF	GJM1555C1H5R4CB01#
			±2%	GJM1555C1H4R3GB01#				±0.5pF	GJM1555C1H5R4DB01#
		4.4pF	±0.05pF	GJM1555C1H4R4WB01#			5.5pF	±0.1pF	GJM1555C1H5R4FB01#
			±0.1pF	GJM1555C1H4R4BB01#				±0.05pF	GJM1555C1H5R5WB01#
			±0.25pF	GJM1555C1H4R4CB01#				±0.1pF	GJM1555C1H5R5BB01#
			±0.5pF	GJM1555C1H4R4DB01#				±0.25pF	GJM1555C1H5R5CB01#
			±2%	GJM1555C1H4R4GB01#				±0.5pF	GJM1555C1H5R5DB01#
		4.5pF	±0.05pF	GJM1555C1H4R5WB01#			5.6pF	±1%	GJM1555C1H5R5FB01#
			±0.1pF	GJM1555C1H4R5BB01#				±0.05pF	GJM1555C1H5R6WB01#
			±0.25pF	GJM1555C1H4R5CB01#				±0.1pF	GJM1555C1H5R6BB01#
			±0.5pF	GJM1555C1H4R5DB01#				±0.25pF	GJM1555C1H5R6CB01#
			±2%	GJM1555C1H4R5GB01#				±0.5pF	GJM1555C1H5R6DB01#
		4.6pF	±0.05pF	GJM1555C1H4R6WB01#			5.7pF	±1%	GJM1555C1H5R6FB01#
			±0.1pF	GJM1555C1H4R6BB01#				±0.05pF	GJM1555C1H5R7WB01#
			±0.25pF	GJM1555C1H4R6CB01#				±0.1pF	GJM1555C1H5R7BB01#
			±0.5pF	GJM1555C1H4R6DB01#				±0.25pF	GJM1555C1H5R7CB01#
			±2%	GJM1555C1H4R6GB01#				±0.5pF	GJM1555C1H5R7DB01#
		4.7pF	±0.05pF	GJM1555C1H4R7WB01#			5.8pF	±1%	GJM1555C1H5R7FB01#
			±0.1pF	GJM1555C1H4R7BB01#				±0.05pF	GJM1555C1H5R8WB01#
			±0.25pF	GJM1555C1H4R7CB01#				±0.1pF	GJM1555C1H5R8BB01#
			±0.5pF	GJM1555C1H4R7DB01#				±0.25pF	GJM1555C1H5R8CB01#
			±2%	GJM1555C1H4R7GB01#				±0.5pF	GJM1555C1H5R8DB01#
		4.8pF	±0.05pF	GJM1555C1H4R8WB01#			5.9pF	±1%	GJM1555C1H5R8FB01#
			±0.1pF	GJM1555C1H4R8BB01#				±0.05pF	GJM1555C1H5R9WB01#
			±0.25pF	GJM1555C1H4R8CB01#				±0.1pF	GJM1555C1H5R9BB01#
			±0.5pF	GJM1555C1H4R8DB01#				±0.25pF	GJM1555C1H5R9CB01#
			±2%	GJM1555C1H4R8GB01#				±0.5pF	GJM1555C1H5R9DB01#
		4.9pF	±0.05pF	GJM1555C1H4R9WB01#			6.0pF	±1%	GJM1555C1H5R9FB01#
			±0.1pF	GJM1555C1H4R9BB01#				±0.05pF	GJM1555C1H6R0WB01#
			±0.25pF	GJM1555C1H4R9CB01#				±0.1pF	GJM1555C1H6R0BB01#
			±0.5pF	GJM1555C1H4R9DB01#				±0.25pF	GJM1555C1H6R0CB01#
			±2%	GJM1555C1H4R9GB01#				±0.5pF	GJM1555C1H6R0DB01#
		5.0pF	±0.05pF	GJM1555C1H5R0WB01#			6.1pF	±1%	GJM1555C1H6R0FB01#
			±0.1pF	GJM1555C1H5R0BB01#				±0.05pF	GJM1555C1H6R1WB01#
			±0.25pF	GJM1555C1H5R0CB01#				±0.1pF	GJM1555C1H6R1BB01#
			±0.5pF	GJM1555C1H5R0DB01#				±0.25pF	GJM1555C1H6R1CB01#
			±1%	GJM1555C1H5R0FB01#				±0.5pF	GJM1555C1H6R1DB01#
		5.1pF	±0.05pF	GJM1555C1H5R1WB01#			6.2pF	±1%	GJM1555C1H6R1FB01#
			±0.1pF	GJM1555C1H5R1BB01#				±0.05pF	GJM1555C1H6R2WB01#
			±0.25pF	GJM1555C1H5R1CB01#				±0.1pF	GJM1555C1H6R2BB01#
			±0.5pF	GJM1555C1H5R1DB01#				±0.25pF	GJM1555C1H6R2CB01#
			±1%	GJM1555C1H5R1FB01#				±0.5pF	GJM1555C1H6R2DB01#
		5.2pF	±0.05pF	GJM1555C1H5R2WB01#			6.3pF	±1%	GJM1555C1H6R2FB01#
			±0.1pF	GJM1555C1H5R2BB01#				±0.05pF	GJM1555C1H6R3WB01#
			±0.25pF	GJM1555C1H5R2CB01#				±0.1pF	GJM1555C1H6R3BB01#
			±0.5pF	GJM1555C1H5R2DB01#				±0.25pF	GJM1555C1H6R3CB01#
			±1%	GJM1555C1H5R2FB01#				±0.5pF	GJM1555C1H6R3DB01#
		5.3pF	±0.05pF	GJM1555C1H5R3WB01#			6.4pF	±1%	GJM1555C1H6R3FB01#
			±0.1pF	GJM1555C1H5R3BB01#				±0.05pF	GJM1555C1H6R4WB01#
			±0.25pF	GJM1555C1H5R3CB01#				±0.1pF	GJM1555C1H6R4BB01#
			±0.5pF	GJM1555C1H5R3DB01#				±0.25pF	GJM1555C1H6R4CB01#
			±1%	GJM1555C1H5R3FB01#				±0.5pF	GJM1555C1H6R4DB01#
		5.4pF	±0.05pF	GJM1555C1H5R4WB01#			±1%	GJM1555C1H6R4FB01#	

- GRM
- GR3
- GRJ
- GR4
- GJM
- GQM
- GQ2
- GA2
- GA3
- GA3
- GA3
- GA3
- LL
- LLA
- LLM
- LLR
- NFM
- GJ4
- ZRA
- ZRB
- KRM
- KR3
- GMA
- GMD
- △Caution / Notice

Part number # indicates the package specification code.

GJM Series Temperature Compensating Type High Q Part Number List

(→ 1.0×0.5mm)

Rated Voltage	TC Code	Cap.	Tol.	Part Number	Rated Voltage	TC Code	Cap.	Tol.	Part Number	
50Vdc	COG	6.5pF	±0.05pF	GJM1555C1H6R5WB01#	50Vdc	COG	7.5pF	±1%	GJM1555C1H7R5FB01#	
			±0.1pF	GJM1555C1H6R5BB01#				7.6pF	±0.05pF	GJM1555C1H7R6WB01#
			±0.25pF	GJM1555C1H6R5CB01#					±0.1pF	GJM1555C1H7R6BB01#
			±0.5pF	GJM1555C1H6R5DB01#					±0.25pF	GJM1555C1H7R6CB01#
			±1%	GJM1555C1H6R5FB01#					±0.5pF	GJM1555C1H7R6DB01#
				±1%			GJM1555C1H7R6FB01#			
		6.6pF	±0.05pF	GJM1555C1H6R6WB01#			7.7pF	±0.05pF	GJM1555C1H7R7WB01#	
			±0.1pF	GJM1555C1H6R6BB01#				±0.1pF	GJM1555C1H7R7BB01#	
			±0.25pF	GJM1555C1H6R6CB01#				±0.25pF	GJM1555C1H7R7CB01#	
			±0.5pF	GJM1555C1H6R6DB01#				±0.5pF	GJM1555C1H7R7DB01#	
			±1%	GJM1555C1H6R6FB01#				±1%	GJM1555C1H7R7FB01#	
		6.7pF	±0.05pF	GJM1555C1H6R7WB01#			7.8pF	±0.05pF	GJM1555C1H7R8WB01#	
			±0.1pF	GJM1555C1H6R7BB01#				±0.1pF	GJM1555C1H7R8BB01#	
			±0.25pF	GJM1555C1H6R7CB01#				±0.25pF	GJM1555C1H7R8CB01#	
			±0.5pF	GJM1555C1H6R7DB01#				±0.5pF	GJM1555C1H7R8DB01#	
			±1%	GJM1555C1H6R7FB01#				±1%	GJM1555C1H7R8FB01#	
		6.8pF	±0.05pF	GJM1555C1H6R8WB01#			7.9pF	±0.05pF	GJM1555C1H7R9WB01#	
			±0.1pF	GJM1555C1H6R8BB01#				±0.1pF	GJM1555C1H7R9BB01#	
			±0.25pF	GJM1555C1H6R8CB01#				±0.25pF	GJM1555C1H7R9CB01#	
			±0.5pF	GJM1555C1H6R8DB01#				±0.5pF	GJM1555C1H7R9DB01#	
			±1%	GJM1555C1H6R8FB01#				±1%	GJM1555C1H7R9FB01#	
		6.9pF	±0.05pF	GJM1555C1H6R9WB01#			8.0pF	±0.05pF	GJM1555C1H8R0WB01#	
			±0.1pF	GJM1555C1H6R9BB01#				±0.1pF	GJM1555C1H8R0BB01#	
			±0.25pF	GJM1555C1H6R9CB01#				±0.25pF	GJM1555C1H8R0CB01#	
			±0.5pF	GJM1555C1H6R9DB01#				±0.5pF	GJM1555C1H8R0DB01#	
			±1%	GJM1555C1H6R9FB01#				±1%	GJM1555C1H8R0FB01#	
		7.0pF	±0.05pF	GJM1555C1H7R0WB01#			8.1pF	±0.05pF	GJM1555C1H8R1WB01#	
			±0.1pF	GJM1555C1H7R0BB01#				±0.1pF	GJM1555C1H8R1BB01#	
			±0.25pF	GJM1555C1H7R0CB01#				±0.25pF	GJM1555C1H8R1CB01#	
			±0.5pF	GJM1555C1H7R0DB01#				±0.5pF	GJM1555C1H8R1DB01#	
			±1%	GJM1555C1H7R0FB01#				±1%	GJM1555C1H8R1FB01#	
		7.1pF	±0.05pF	GJM1555C1H7R1WB01#			8.2pF	±0.05pF	GJM1555C1H8R2WB01#	
			±0.1pF	GJM1555C1H7R1BB01#				±0.1pF	GJM1555C1H8R2BB01#	
			±0.25pF	GJM1555C1H7R1CB01#				±0.25pF	GJM1555C1H8R2CB01#	
			±0.5pF	GJM1555C1H7R1DB01#				±0.5pF	GJM1555C1H8R2DB01#	
			±1%	GJM1555C1H7R1FB01#				±1%	GJM1555C1H8R2FB01#	
		7.2pF	±0.05pF	GJM1555C1H7R2WB01#			8.3pF	±0.05pF	GJM1555C1H8R3WB01#	
			±0.1pF	GJM1555C1H7R2BB01#				±0.1pF	GJM1555C1H8R3BB01#	
			±0.25pF	GJM1555C1H7R2CB01#				±0.25pF	GJM1555C1H8R3CB01#	
			±0.5pF	GJM1555C1H7R2DB01#				±0.5pF	GJM1555C1H8R3DB01#	
			±1%	GJM1555C1H7R2FB01#				±1%	GJM1555C1H8R3FB01#	
		7.3pF	±0.05pF	GJM1555C1H7R3WB01#			8.4pF	±0.05pF	GJM1555C1H8R4WB01#	
			±0.1pF	GJM1555C1H7R3BB01#				±0.1pF	GJM1555C1H8R4BB01#	
			±0.25pF	GJM1555C1H7R3CB01#				±0.25pF	GJM1555C1H8R4CB01#	
			±0.5pF	GJM1555C1H7R3DB01#				±0.5pF	GJM1555C1H8R4DB01#	
			±1%	GJM1555C1H7R3FB01#				±1%	GJM1555C1H8R4FB01#	
		7.4pF	±0.05pF	GJM1555C1H7R4WB01#			8.5pF	±0.05pF	GJM1555C1H8R5WB01#	
			±0.1pF	GJM1555C1H7R4BB01#				±0.1pF	GJM1555C1H8R5BB01#	
			±0.25pF	GJM1555C1H7R4CB01#				±0.25pF	GJM1555C1H8R5CB01#	
			±0.5pF	GJM1555C1H7R4DB01#				±0.5pF	GJM1555C1H8R5DB01#	
			±1%	GJM1555C1H7R4FB01#				±1%	GJM1555C1H8R5FB01#	
		7.5pF	±0.05pF	GJM1555C1H7R5WB01#			8.6pF	±0.05pF	GJM1555C1H8R6WB01#	
			±0.1pF	GJM1555C1H7R5BB01#				±0.1pF	GJM1555C1H8R6BB01#	
			±0.25pF	GJM1555C1H7R5CB01#				±0.25pF	GJM1555C1H8R6CB01#	
			±0.5pF	GJM1555C1H7R5DB01#						

- GRM
- GR3
- GRJ
- GR4
- GJM
- GQM
- GA2
- GA3 GB
- GA3 GD
- GA3 GF
- LLL
- LLA
- LLM
- LLR
- NFM
- GJ4
- ZRA
- ZRB
- KRM
- KR3
- GMA
- GMD
- △Caution /Notice

Part number # indicates the package specification code.

GJM Series Temperature Compensating Type High Q Part Number List

(→ 1.0×0.5mm)

Rated Voltage	TC Code	Cap.	Tol.	Part Number	Rated Voltage	TC Code	Cap.	Tol.	Part Number
50Vdc	COG	8.6pF	±0.5pF	GJM1555C1H8R6DB01#	50Vdc	COG	9.7pF	±0.25pF	GJM1555C1H9R7CB01#
			±1%	GJM1555C1H8R6FB01#				±0.5pF	GJM1555C1H9R7DB01#
		8.7pF	±0.05pF	GJM1555C1H8R7WB01#			±1%	GJM1555C1H9R7FB01#	
			±0.1pF	GJM1555C1H8R7BB01#			9.8pF	±0.05pF	GJM1555C1H9R8WB01#
			±0.25pF	GJM1555C1H8R7CB01#				±0.1pF	GJM1555C1H9R8BB01#
			±0.5pF	GJM1555C1H8R7DB01#				±0.25pF	GJM1555C1H9R8CB01#
			±1%	GJM1555C1H8R7FB01#				±0.5pF	GJM1555C1H9R8DB01#
		±1%	GJM1555C1H8R7FB01#	±1%				GJM1555C1H9R8FB01#	
		8.8pF	±0.05pF	GJM1555C1H8R8WB01#			9.9pF	±0.05pF	GJM1555C1H9R9WB01#
			±0.1pF	GJM1555C1H8R8BB01#				±0.1pF	GJM1555C1H9R9BB01#
			±0.25pF	GJM1555C1H8R8CB01#				±0.25pF	GJM1555C1H9R9CB01#
			±0.5pF	GJM1555C1H8R8DB01#				±0.5pF	GJM1555C1H9R9DB01#
			±1%	GJM1555C1H8R8FB01#				±1%	GJM1555C1H9R9FB01#
		8.9pF	±0.05pF	GJM1555C1H8R9WB01#			10pF	±1%	GJM1555C1H100FB01#
			±0.1pF	GJM1555C1H8R9BB01#				±2%	GJM1555C1H100GB01#
			±0.25pF	GJM1555C1H8R9CB01#				±2.5%	GJM1555C1H100RB01#
			±0.5pF	GJM1555C1H8R9DB01#				±5%	GJM1555C1H100JB01#
			±1%	GJM1555C1H8R9FB01#				11pF	±1%
		9.0pF	±0.05pF	GJM1555C1H9R0WB01#			±2%		GJM1555C1H110GB01#
			±0.1pF	GJM1555C1H9R0BB01#			±5%		GJM1555C1H110JB01#
			±0.25pF	GJM1555C1H9R0CB01#			12pF	±1%	GJM1555C1H120FB01#
		±0.5pF	GJM1555C1H9R0DB01#	±2%				GJM1555C1H120GB01#	
		±1%	GJM1555C1H9R0FB01#	±5%				GJM1555C1H120JB01#	
		9.1pF	±0.05pF	GJM1555C1H9R1WB01#			13pF	±1%	GJM1555C1H130FB01#
			±0.1pF	GJM1555C1H9R1BB01#				±2%	GJM1555C1H130GB01#
			±0.25pF	GJM1555C1H9R1CB01#				±5%	GJM1555C1H130JB01#
			±0.5pF	GJM1555C1H9R1DB01#			14pF	±1%	GJM1555C1H140FB01#
			±1%	GJM1555C1H9R1FB01#				±2%	GJM1555C1H140GB01#
		±1%	GJM1555C1H9R1FB01#	±5%				GJM1555C1H140JB01#	
		9.2pF	±0.05pF	GJM1555C1H9R2WB01#			15pF	±1%	GJM1555C1H150FB01#
			±0.1pF	GJM1555C1H9R2BB01#				±2%	GJM1555C1H150GB01#
			±0.25pF	GJM1555C1H9R2CB01#				±5%	GJM1555C1H150JB01#
			±0.5pF	GJM1555C1H9R2DB01#			16pF	±1%	GJM1555C1H160FB01#
			±1%	GJM1555C1H9R2FB01#				±2%	GJM1555C1H160GB01#
		±1%	GJM1555C1H9R2FB01#	±5%				GJM1555C1H160JB01#	
		9.3pF	±0.05pF	GJM1555C1H9R3WB01#			17pF	±1%	GJM1555C1H170FB01#
			±0.1pF	GJM1555C1H9R3BB01#				±2%	GJM1555C1H170GB01#
			±0.25pF	GJM1555C1H9R3CB01#				±5%	GJM1555C1H170JB01#
			±0.5pF	GJM1555C1H9R3DB01#			18pF	±1%	GJM1555C1H180FB01#
			±1%	GJM1555C1H9R3FB01#				±2%	GJM1555C1H180GB01#
		±1%	GJM1555C1H9R3FB01#	±5%				GJM1555C1H180JB01#	
		9.4pF	±0.05pF	GJM1555C1H9R4WB01#			19pF	±1%	GJM1555C1H190FB01#
			±0.1pF	GJM1555C1H9R4BB01#				±2%	GJM1555C1H190GB01#
			±0.25pF	GJM1555C1H9R4CB01#				±5%	GJM1555C1H190JB01#
			±0.5pF	GJM1555C1H9R4DB01#			20pF	±1%	GJM1555C1H200FB01#
			±1%	GJM1555C1H9R4FB01#				±2%	GJM1555C1H200GB01#
		±1%	GJM1555C1H9R4FB01#	±5%				GJM1555C1H200JB01#	
		9.5pF	±0.05pF	GJM1555C1H9R5WB01#			22pF	±1%	GJM1555C1H220FB01#
			±0.1pF	GJM1555C1H9R5BB01#				±2%	GJM1555C1H220GB01#
			±0.25pF	GJM1555C1H9R5CB01#				±5%	GJM1555C1H220JB01#
			±0.5pF	GJM1555C1H9R5DB01#			24pF	±1%	GJM1555C1H240FB01#
			±1%	GJM1555C1H9R5FB01#				±2%	GJM1555C1H240GB01#
±1%	GJM1555C1H9R5FB01#	±5%	GJM1555C1H240JB01#						
9.6pF	±0.05pF	GJM1555C1H9R6WB01#	27pF	±1%	GJM1555C1H270FB01#				
	±0.1pF	GJM1555C1H9R6BB01#							
	±0.25pF	GJM1555C1H9R6CB01#							
	±0.5pF	GJM1555C1H9R6DB01#							
	±1%	GJM1555C1H9R6FB01#							
9.7pF	±0.05pF	GJM1555C1H9R7WB01#							
	±0.1pF	GJM1555C1H9R7BB01#							

Part number # indicates the package specification code.

GRM
 GR3
 GRJ
 GR4
 GJM
 GQM
 GA2
 GA3 GB
 GA3 GD
 GA3 GF
 LLL
 LLA
 LLM
 LLR
 NFM
 GJ4
 ZRA
 ZRB
 KRM
 KR3
 GMA
 GMD
 ⚠Caution /Notice

GJM Series Temperature Compensating Type **High Q** Part Number List

(→ 1.0×0.5mm)

Rated Voltage	TC Code	Cap.	Tol.	Part Number	Rated Voltage	TC Code	Cap.	Tol.	Part Number	
50Vdc	COG	27pF	±2%	GJM1555C1H270GB01#	50Vdc	CG	0.36pF	±0.1pF	GJM1551C1HR36BB01#	
			±5%	GJM1555C1H270JB01#				±0.25pF	GJM1551C1HR36CB01#	
		30pF	±1%	GJM1555C1H300FB01#			0.39pF	±0.05pF	GJM1551C1HR39WB01#	
			±2%	GJM1555C1H300GB01#			±0.1pF	GJM1551C1HR39BB01#		
			±5%	GJM1555C1H300JB01#			±0.25pF	GJM1551C1HR39CB01#		
			33pF	±1%			GJM1555C1H330FB01#	0.40pF	±0.05pF	GJM1551C1HR40WB01#
		±2%		GJM1555C1H330GB01#			±0.1pF	GJM1551C1HR40BB01#		
		±5%		GJM1555C1H330JB01#			±0.25pF	GJM1551C1HR40CB01#		
		36pF	±1%	GJM1555C1H360FB01#			0.43pF	±0.05pF	GJM1551C1HR43WB01#	
			±2%	GJM1555C1H360GB01#			±0.1pF	GJM1551C1HR43BB01#		
			±5%	GJM1555C1H360JB01#			±0.25pF	GJM1551C1HR43CB01#		
		39pF	±1%	GJM1555C1H390FB01#			0.45pF	±0.03pF	GJM1551C1HR45RB12#	
			±2%	GJM1555C1H390GB01#			±0.05pF	GJM1551C1HR45WB01#		
			±5%	GJM1555C1H390JB01#			0.47pF	±0.05pF	GJM1551C1HR47WB01#	
		43pF	±1%	GJM1555C1H430FB01#				±0.1pF	GJM1551C1HR47BB01#	
			±2%	GJM1555C1H430GB01#				±0.25pF	GJM1551C1HR47CB01#	
			±5%	GJM1555C1H430JB01#			0.50pF	±0.03pF	GJM1551C1HR50RB12#	
		47pF	±1%	GJM1555C1H470FB01#				±0.05pF	GJM1551C1HR50WB01#	
			±2%	GJM1555C1H470GB01#				±0.1pF	GJM1551C1HR50BB01#	
			±5%	GJM1555C1H470JB01#			±0.25pF	GJM1551C1HR50CB01#		
		CG	0.10pF	±0.05pF			GJM1551C1HR10WB01#	±0.5pF	GJM1551C1HR50DB01#	
				±0.1pF			GJM1551C1HR10BB01#	0.51pF	±0.05pF	GJM1551C1HR51WB01#
				±20%			GJM1551C1HR10MB01#		±0.1pF	GJM1551C1HR51BB01#
			0.11pF	±0.05pF			GJM1551C1HR11WB01#		±0.25pF	GJM1551C1HR51CB01#
				±0.1pF			GJM1551C1HR11BB01#	±0.5pF	GJM1551C1HR51DB01#	
			0.12pF	±0.05pF			GJM1551C1HR12WB01#	0.56pF	±0.05pF	GJM1551C1HR56WB01#
				±0.1pF			GJM1551C1HR12BB01#		±0.1pF	GJM1551C1HR56BB01#
			0.13pF	±0.05pF			GJM1551C1HR13WB01#	±0.25pF	GJM1551C1HR56CB01#	
				±0.1pF			GJM1551C1HR13BB01#	±0.5pF	GJM1551C1HR56DB01#	
			0.15pF	±0.03pF			GJM1551C1HR15RB12#	0.60pF	±0.05pF	GJM1551C1HR60WB01#
				±0.05pF			GJM1551C1HR15WB01#		±0.1pF	GJM1551C1HR60BB01#
				±0.1pF			GJM1551C1HR15BB01#		±0.25pF	GJM1551C1HR60CB01#
			0.16pF	±0.05pF			GJM1551C1HR16WB01#	±0.5pF	GJM1551C1HR60DB01#	
				±0.1pF			GJM1551C1HR16BB01#	0.62pF	±0.05pF	GJM1551C1HR62WB01#
			0.18pF	±0.05pF			GJM1551C1HR18WB01#		±0.1pF	GJM1551C1HR62BB01#
				±0.1pF			GJM1551C1HR18BB01#	±0.25pF	GJM1551C1HR62CB01#	
	0.20pF		±0.05pF	GJM1551C1HR20WB01#			±0.5pF	GJM1551C1HR62DB01#		
			±0.1pF	GJM1551C1HR20BB01#			0.68pF	±0.05pF	GJM1551C1HR68WB01#	
	0.22pF		±0.05pF	GJM1551C1HR22WB01#				±0.1pF	GJM1551C1HR68BB01#	
			±0.1pF	GJM1551C1HR22BB01#				±0.25pF	GJM1551C1HR68CB01#	
	0.24pF		±0.05pF	GJM1551C1HR24WB01#			±0.5pF	GJM1551C1HR68DB01#		
			±0.1pF	GJM1551C1HR24BB01#			0.70pF	±0.05pF	GJM1551C1HR70WB01#	
	0.25pF		±0.03pF	GJM1551C1HR25RB12#				±0.1pF	GJM1551C1HR70BB01#	
			±0.1pF	GJM1551C1HR25BB01#				±0.25pF	GJM1551C1HR70CB01#	
	0.27pF		±0.05pF	GJM1551C1HR27WB01#			±0.5pF	GJM1551C1HR70DB01#		
			±0.1pF	GJM1551C1HR27BB01#			0.75pF	±0.05pF	GJM1551C1HR75WB01#	
			±0.25pF	GJM1551C1HR27CB01#				±0.1pF	GJM1551C1HR75BB01#	
	0.30pF		±0.05pF	GJM1551C1HR30WB01#				±0.25pF	GJM1551C1HR75CB01#	
±0.1pF			GJM1551C1HR30BB01#	±0.5pF	GJM1551C1HR75DB01#					
±0.25pF			GJM1551C1HR30CB01#	0.80pF	±0.05pF	GJM1551C1HR80WB01#				
0.33pF	±0.05pF		GJM1551C1HR33WB01#		±0.1pF	GJM1551C1HR80BB01#				
	±0.1pF		GJM1551C1HR33BB01#		±0.25pF	GJM1551C1HR80CB01#				
	±0.25pF		GJM1551C1HR33CB01#	±0.5pF	GJM1551C1HR80DB01#					
0.36pF	±0.05pF		GJM1551C1HR36WB01#	0.82pF	±0.05pF	GJM1551C1HR82WB01#				

Part number # indicates the package specification code.

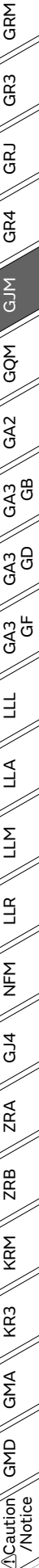

GJM Series Temperature Compensating Type **High Q** Part Number List

(→ 1.0×0.5mm)

Rated Voltage	TC Code	Cap.	Tol.	Part Number	Rated Voltage	TC Code	Cap.	Tol.	Part Number
50Vdc	CG	0.82pF	±0.1pF	GJM1551C1HR82BB01#	50Vdc	CG	1.8pF	±0.1pF	GJM1551C1H1R8BB01#
			±0.25pF	GJM1551C1HR82CB01#				±0.25pF	GJM1551C1H1R8CB01#
			±0.5pF	GJM1551C1HR82DB01#				±0.5pF	GJM1551C1H1R8DB01#
		0.85pF	±0.05pF	GJM1551C1HR85WB01#			±5%	GJM1551C1H1R8JB01#	
		0.90pF	±0.05pF	GJM1551C1HR90WB01#			1.9pF	±0.05pF	GJM1551C1H1R9WB01#
			±0.1pF	GJM1551C1HR90BB01#				±0.1pF	GJM1551C1H1R9BB01#
			±0.25pF	GJM1551C1HR90CB01#				±0.25pF	GJM1551C1H1R9CB01#
			±0.5pF	GJM1551C1HR90DB01#				±0.5pF	GJM1551C1H1R9DB01#
		0.91pF	±0.05pF	GJM1551C1HR91WB01#			±5%	GJM1551C1H1R9JB01#	
			±0.1pF	GJM1551C1HR91BB01#			2.0pF	±0.05pF	GJM1551C1H2R0WB01#
			±0.25pF	GJM1551C1HR91CB01#				±0.1pF	GJM1551C1H2R0BB01#
			±0.5pF	GJM1551C1HR91DB01#				±0.25pF	GJM1551C1H2R0CB01#
		±0.05pF	GJM1551C1HR95WB01#	±0.5pF				GJM1551C1H2R0DB01#	
		1.0pF	±0.05pF	GJM1551C1H1R0WB01#			±2%	GJM1551C1H2R0GB01#	
			±0.1pF	GJM1551C1H1R0BB01#			2.1pF	±0.05pF	GJM1551C1H2R1WB01#
			±0.25pF	GJM1551C1H1R0CB01#				±0.1pF	GJM1551C1H2R1BB01#
			±0.5pF	GJM1551C1H1R0DB01#				±0.25pF	GJM1551C1H2R1CB01#
			±5%	GJM1551C1H1R0JB01#				±0.5pF	GJM1551C1H2R1DB01#
		±0.05pF	GJM1551C1H1R1WB01#	±2%				GJM1551C1H2R1GB01#	
		1.1pF	±0.1pF	GJM1551C1H1R1BB01#			2.2pF	±0.05pF	GJM1551C1H2R2WB01#
			±0.25pF	GJM1551C1H1R1CB01#				±0.1pF	GJM1551C1H2R2BB01#
			±0.5pF	GJM1551C1H1R1DB01#				±0.25pF	GJM1551C1H2R2CB01#
			±5%	GJM1551C1H1R1JB01#				±0.5pF	GJM1551C1H2R2DB01#
			±0.05pF	GJM1551C1H1R2WB01#				±2%	GJM1551C1H2R2GB01#
		1.2pF	±0.1pF	GJM1551C1H1R2BB01#			2.3pF	±0.05pF	GJM1551C1H2R3WB01#
			±0.25pF	GJM1551C1H1R2CB01#				±0.1pF	GJM1551C1H2R3BB01#
			±0.5pF	GJM1551C1H1R2DB01#				±0.25pF	GJM1551C1H2R3CB01#
			±5%	GJM1551C1H1R2JB01#				±0.5pF	GJM1551C1H2R3DB01#
			±0.05pF	GJM1551C1H1R3WB01#				±2%	GJM1551C1H2R3GB01#
		1.3pF	±0.1pF	GJM1551C1H1R3BB01#			2.4pF	±0.05pF	GJM1551C1H2R4WB01#
			±0.25pF	GJM1551C1H1R3CB01#				±0.1pF	GJM1551C1H2R4BB01#
			±0.5pF	GJM1551C1H1R3DB01#				±0.25pF	GJM1551C1H2R4CB01#
			±5%	GJM1551C1H1R3JB01#				±0.5pF	GJM1551C1H2R4DB01#
			±0.05pF	GJM1551C1H1R4WB01#				±2%	GJM1551C1H2R4GB01#
		1.4pF	±0.1pF	GJM1551C1H1R4BB01#			2.5pF	±0.05pF	GJM1551C1H2R5WB01#
			±0.25pF	GJM1551C1H1R4CB01#				±0.1pF	GJM1551C1H2R5BB01#
			±0.5pF	GJM1551C1H1R4DB01#				±0.25pF	GJM1551C1H2R5CB01#
			±5%	GJM1551C1H1R4JB01#				±0.5pF	GJM1551C1H2R5DB01#
			±0.05pF	GJM1551C1H1R5WB01#				±2%	GJM1551C1H2R5GB01#
		1.5pF	±0.1pF	GJM1551C1H1R5BB01#			2.6pF	±0.05pF	GJM1551C1H2R6WB01#
			±0.25pF	GJM1551C1H1R5CB01#				±0.1pF	GJM1551C1H2R6BB01#
			±0.5pF	GJM1551C1H1R5DB01#				±0.25pF	GJM1551C1H2R6CB01#
			±5%	GJM1551C1H1R5JB01#				±0.5pF	GJM1551C1H2R6DB01#
			±0.05pF	GJM1551C1H1R6WB01#				±2%	GJM1551C1H2R6GB01#
		1.6pF	±0.1pF	GJM1551C1H1R6BB01#			2.7pF	±0.05pF	GJM1551C1H2R7WB01#
			±0.25pF	GJM1551C1H1R6CB01#				±0.1pF	GJM1551C1H2R7BB01#
			±0.5pF	GJM1551C1H1R6DB01#				±0.25pF	GJM1551C1H2R7CB01#
			±5%	GJM1551C1H1R6JB01#				±0.5pF	GJM1551C1H2R7DB01#
			±0.05pF	GJM1551C1H1R7WB01#				±2%	GJM1551C1H2R7GB01#
		1.7pF	±0.1pF	GJM1551C1H1R7BB01#			2.8pF	±0.05pF	GJM1551C1H2R8WB01#
			±0.25pF	GJM1551C1H1R7CB01#				±0.1pF	GJM1551C1H2R8BB01#
			±0.5pF	GJM1551C1H1R7DB01#				±0.25pF	GJM1551C1H2R8CB01#
			±5%	GJM1551C1H1R7JB01#				±0.5pF	GJM1551C1H2R8DB01#
			±0.05pF	GJM1551C1H1R8WB01#				±2%	GJM1551C1H2R8GB01#

Part number # indicates the package specification code.

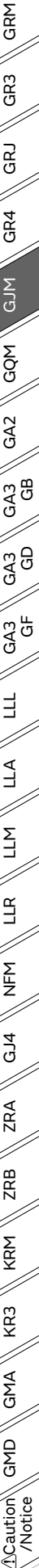

GJM Series Temperature Compensating Type High Q Part Number List

(→ 1.0×0.5mm)

Rated Voltage	TC Code	Cap.	Tol.	Part Number	Rated Voltage	TC Code	Cap.	Tol.	Part Number	
50Vdc	CG	2.9pF	±0.05pF	GJM1551C1H2R9WB01#	50Vdc	CG	3.9pF	±2%	GJM1551C1H3R9GB01#	
			±0.1pF	GJM1551C1H2R9BB01#				4.0pF	±0.05pF	GJM1551C1H4R0WB01#
			±0.25pF	GJM1551C1H2R9CB01#					±0.1pF	GJM1551C1H4R0BB01#
			±0.5pF	GJM1551C1H2R9DB01#					±0.25pF	GJM1551C1H4R0CB01#
			±2%	GJM1551C1H2R9GB01#					±0.5pF	GJM1551C1H4R0DB01#
				±2%			GJM1551C1H4R0GB01#			
		3.0pF	±0.05pF	GJM1551C1H3R0WB01#			4.1pF	±0.05pF	GJM1551C1H4R1WB01#	
			±0.1pF	GJM1551C1H3R0BB01#				±0.1pF	GJM1551C1H4R1BB01#	
			±0.25pF	GJM1551C1H3R0CB01#				±0.25pF	GJM1551C1H4R1CB01#	
			±0.5pF	GJM1551C1H3R0DB01#				±0.5pF	GJM1551C1H4R1DB01#	
			±2%	GJM1551C1H3R0GB01#				±2%	GJM1551C1H4R1GB01#	
		3.1pF	±0.05pF	GJM1551C1H3R1WB01#			4.2pF	±0.05pF	GJM1551C1H4R2WB01#	
			±0.1pF	GJM1551C1H3R1BB01#				±0.1pF	GJM1551C1H4R2BB01#	
			±0.25pF	GJM1551C1H3R1CB01#				±0.25pF	GJM1551C1H4R2CB01#	
			±0.5pF	GJM1551C1H3R1DB01#				±0.5pF	GJM1551C1H4R2DB01#	
			±2%	GJM1551C1H3R1GB01#				±2%	GJM1551C1H4R2GB01#	
		3.2pF	±0.05pF	GJM1551C1H3R2WB01#			4.3pF	±0.05pF	GJM1551C1H4R3WB01#	
			±0.1pF	GJM1551C1H3R2BB01#				±0.1pF	GJM1551C1H4R3BB01#	
			±0.25pF	GJM1551C1H3R2CB01#				±0.25pF	GJM1551C1H4R3CB01#	
			±0.5pF	GJM1551C1H3R2DB01#				±0.5pF	GJM1551C1H4R3DB01#	
			±2%	GJM1551C1H3R2GB01#				±2%	GJM1551C1H4R3GB01#	
		3.3pF	±0.05pF	GJM1551C1H3R3WB01#			4.4pF	±0.05pF	GJM1551C1H4R4WB01#	
			±0.1pF	GJM1551C1H3R3BB01#				±0.1pF	GJM1551C1H4R4BB01#	
			±0.25pF	GJM1551C1H3R3CB01#				±0.25pF	GJM1551C1H4R4CB01#	
			±0.5pF	GJM1551C1H3R3DB01#				±0.5pF	GJM1551C1H4R4DB01#	
			±2%	GJM1551C1H3R3GB01#				±2%	GJM1551C1H4R4GB01#	
		3.4pF	±0.05pF	GJM1551C1H3R4WB01#			4.5pF	±0.05pF	GJM1551C1H4R5WB01#	
			±0.1pF	GJM1551C1H3R4BB01#				±0.1pF	GJM1551C1H4R5BB01#	
			±0.25pF	GJM1551C1H3R4CB01#				±0.25pF	GJM1551C1H4R5CB01#	
			±0.5pF	GJM1551C1H3R4DB01#				±0.5pF	GJM1551C1H4R5DB01#	
			±2%	GJM1551C1H3R4GB01#				±2%	GJM1551C1H4R5GB01#	
		3.5pF	±0.05pF	GJM1551C1H3R5WB01#			4.6pF	±0.05pF	GJM1551C1H4R6WB01#	
			±0.1pF	GJM1551C1H3R5BB01#				±0.1pF	GJM1551C1H4R6BB01#	
			±0.25pF	GJM1551C1H3R5CB01#				±0.25pF	GJM1551C1H4R6CB01#	
			±0.5pF	GJM1551C1H3R5DB01#				±0.5pF	GJM1551C1H4R6DB01#	
			±2%	GJM1551C1H3R5GB01#				±2%	GJM1551C1H4R6GB01#	
		3.6pF	±0.05pF	GJM1551C1H3R6WB01#			4.7pF	±0.05pF	GJM1551C1H4R7WB01#	
			±0.1pF	GJM1551C1H3R6BB01#				±0.1pF	GJM1551C1H4R7BB01#	
			±0.25pF	GJM1551C1H3R6CB01#				±0.25pF	GJM1551C1H4R7CB01#	
			±0.5pF	GJM1551C1H3R6DB01#				±0.5pF	GJM1551C1H4R7DB01#	
			±2%	GJM1551C1H3R6GB01#				±2%	GJM1551C1H4R7GB01#	
		3.7pF	±0.05pF	GJM1551C1H3R7WB01#			4.8pF	±0.05pF	GJM1551C1H4R8WB01#	
			±0.1pF	GJM1551C1H3R7BB01#				±0.1pF	GJM1551C1H4R8BB01#	
			±0.25pF	GJM1551C1H3R7CB01#				±0.25pF	GJM1551C1H4R8CB01#	
			±0.5pF	GJM1551C1H3R7DB01#				±0.5pF	GJM1551C1H4R8DB01#	
			±2%	GJM1551C1H3R7GB01#				±2%	GJM1551C1H4R8GB01#	
		3.8pF	±0.05pF	GJM1551C1H3R8WB01#			4.9pF	±0.05pF	GJM1551C1H4R9WB01#	
			±0.1pF	GJM1551C1H3R8BB01#				±0.1pF	GJM1551C1H4R9BB01#	
			±0.25pF	GJM1551C1H3R8CB01#				±0.25pF	GJM1551C1H4R9CB01#	
			±0.5pF	GJM1551C1H3R8DB01#				±0.5pF	GJM1551C1H4R9DB01#	
±2%	GJM1551C1H3R8GB01#		±2%	GJM1551C1H4R9GB01#						
3.9pF	±0.05pF	GJM1551C1H3R9WB01#	5.0pF	±0.05pF	GJM1551C1H5R0WB01#					
	±0.1pF	GJM1551C1H3R9BB01#		±0.1pF	GJM1551C1H5R0BB01#					
	±0.25pF	GJM1551C1H3R9CB01#		±0.25pF	GJM1551C1H5R0CB01#					
	±0.5pF	GJM1551C1H3R9DB01#								

Part number # indicates the package specification code.

GRM
 GR3
 GRJ
 GR4
 GJM
 GQM
 GA2
 GA3 GB
 GA3 GD
 GA3 GF
 LLL
 LLA
 LLM
 LLR
 NFM
 GJ4
 ZRA
 ZRB
 KRM
 KR3
 GMA
 GMD
 ⚠Caution /Notice

GJM Series Temperature Compensating Type High Q Part Number List

(→ 1.0×0.5mm)

Rated Voltage	TC Code	Cap.	Tol.	Part Number	Rated Voltage	TC Code	Cap.	Tol.	Part Number
50Vdc	CG	5.0pF	±0.5pF	GJM1551C1H5R0DB01#	50Vdc	CG	6.1pF	±0.25pF	GJM1551C1H6R1CB01#
			±1%	GJM1551C1H5R0FB01#				±0.5pF	GJM1551C1H6R1DB01#
		5.1pF	±0.05pF	GJM1551C1H5R1WB01#				±1%	GJM1551C1H6R1FB01#
			±0.1pF	GJM1551C1H5R1BB01#			6.2pF	±0.05pF	GJM1551C1H6R2WB01#
			±0.25pF	GJM1551C1H5R1CB01#				±0.1pF	GJM1551C1H6R2BB01#
			±0.5pF	GJM1551C1H5R1DB01#				±0.25pF	GJM1551C1H6R2CB01#
			±1%	GJM1551C1H5R1FB01#				±0.5pF	GJM1551C1H6R2DB01#
		±1%	GJM1551C1H5R1FB01#	±1%				GJM1551C1H6R2FB01#	
		5.2pF	±0.05pF	GJM1551C1H5R2WB01#			6.3pF	±0.05pF	GJM1551C1H6R3WB01#
			±0.1pF	GJM1551C1H5R2BB01#				±0.1pF	GJM1551C1H6R3BB01#
			±0.25pF	GJM1551C1H5R2CB01#				±0.25pF	GJM1551C1H6R3CB01#
			±0.5pF	GJM1551C1H5R2DB01#				±0.5pF	GJM1551C1H6R3DB01#
			±1%	GJM1551C1H5R2FB01#				±1%	GJM1551C1H6R3FB01#
		5.3pF	±0.05pF	GJM1551C1H5R3WB01#			6.4pF	±0.05pF	GJM1551C1H6R4WB01#
			±0.1pF	GJM1551C1H5R3BB01#				±0.1pF	GJM1551C1H6R4BB01#
			±0.25pF	GJM1551C1H5R3CB01#				±0.25pF	GJM1551C1H6R4CB01#
			±0.5pF	GJM1551C1H5R3DB01#				±0.5pF	GJM1551C1H6R4DB01#
			±1%	GJM1551C1H5R3FB01#				±1%	GJM1551C1H6R4FB01#
		5.4pF	±0.05pF	GJM1551C1H5R4WB01#			6.5pF	±0.05pF	GJM1551C1H6R5WB01#
			±0.1pF	GJM1551C1H5R4BB01#				±0.1pF	GJM1551C1H6R5BB01#
			±0.25pF	GJM1551C1H5R4CB01#				±0.25pF	GJM1551C1H6R5CB01#
			±0.5pF	GJM1551C1H5R4DB01#				±0.5pF	GJM1551C1H6R5DB01#
			±1%	GJM1551C1H5R4FB01#				±1%	GJM1551C1H6R5FB01#
		5.5pF	±0.05pF	GJM1551C1H5R5WB01#			6.6pF	±0.05pF	GJM1551C1H6R6WB01#
			±0.1pF	GJM1551C1H5R5BB01#				±0.1pF	GJM1551C1H6R6BB01#
			±0.25pF	GJM1551C1H5R5CB01#				±0.25pF	GJM1551C1H6R6CB01#
			±0.5pF	GJM1551C1H5R5DB01#				±0.5pF	GJM1551C1H6R6DB01#
			±1%	GJM1551C1H5R5FB01#				±1%	GJM1551C1H6R6FB01#
		5.6pF	±0.05pF	GJM1551C1H5R6WB01#			6.7pF	±0.05pF	GJM1551C1H6R7WB01#
			±0.1pF	GJM1551C1H5R6BB01#				±0.1pF	GJM1551C1H6R7BB01#
			±0.25pF	GJM1551C1H5R6CB01#				±0.25pF	GJM1551C1H6R7CB01#
			±0.5pF	GJM1551C1H5R6DB01#				±0.5pF	GJM1551C1H6R7DB01#
			±1%	GJM1551C1H5R6FB01#				±1%	GJM1551C1H6R7FB01#
		5.7pF	±0.05pF	GJM1551C1H5R7WB01#			6.8pF	±0.05pF	GJM1551C1H6R8WB01#
			±0.1pF	GJM1551C1H5R7BB01#				±0.1pF	GJM1551C1H6R8BB01#
			±0.25pF	GJM1551C1H5R7CB01#				±0.25pF	GJM1551C1H6R8CB01#
			±0.5pF	GJM1551C1H5R7DB01#				±0.5pF	GJM1551C1H6R8DB01#
			±1%	GJM1551C1H5R7FB01#				±1%	GJM1551C1H6R8FB01#
		5.8pF	±0.05pF	GJM1551C1H5R8WB01#			6.9pF	±0.05pF	GJM1551C1H6R9WB01#
			±0.1pF	GJM1551C1H5R8BB01#				±0.1pF	GJM1551C1H6R9BB01#
			±0.25pF	GJM1551C1H5R8CB01#				±0.25pF	GJM1551C1H6R9CB01#
			±0.5pF	GJM1551C1H5R8DB01#				±0.5pF	GJM1551C1H6R9DB01#
			±1%	GJM1551C1H5R8FB01#				±1%	GJM1551C1H6R9FB01#
		5.9pF	±0.05pF	GJM1551C1H5R9WB01#			7.0pF	±0.05pF	GJM1551C1H7R0WB01#
			±0.1pF	GJM1551C1H5R9BB01#				±0.1pF	GJM1551C1H7R0BB01#
			±0.25pF	GJM1551C1H5R9CB01#				±0.25pF	GJM1551C1H7R0CB01#
			±0.5pF	GJM1551C1H5R9DB01#				±0.5pF	GJM1551C1H7R0DB01#
			±1%	GJM1551C1H5R9FB01#				±1%	GJM1551C1H7R0FB01#
		6.0pF	±0.05pF	GJM1551C1H6R0WB01#			7.1pF	±0.05pF	GJM1551C1H7R1WB01#
			±0.1pF	GJM1551C1H6R0BB01#				±0.1pF	GJM1551C1H7R1BB01#
			±0.25pF	GJM1551C1H6R0CB01#				±0.25pF	GJM1551C1H7R1CB01#
			±0.5pF	GJM1551C1H6R0DB01#				±0.5pF	GJM1551C1H7R1DB01#
			±1%	GJM1551C1H6R0FB01#				±1%	GJM1551C1H7R1FB01#
		6.1pF	±0.05pF	GJM1551C1H6R1WB01#			7.2pF	±0.05pF	GJM1551C1H7R2WB01#
			±0.1pF	GJM1551C1H6R1BB01#					

- GRM
- GR3
- GRJ
- GR4
- GJM
- GQM
- GQ2
- GA2
- GA3
- GA3
- GA3
- GA3
- GA3
- LL
- LLA
- LLM
- LLR
- NFM
- GJ4
- ZRA
- ZRB
- KRM
- KR3
- GMA
- GMD
- ⚠Caution / Notice

Part number # indicates the package specification code.

GJM Series Temperature Compensating Type High Q Part Number List

(→ 1.0×0.5mm)

Rated Voltage	TC Code	Cap.	Tol.	Part Number	Rated Voltage	TC Code	Cap.	Tol.	Part Number	
50Vdc	CG	7.2pF	±0.1pF	GJM1551C1H7R2BB01#	50Vdc	CG	8.3pF	±0.05pF	GJM1551C1H8R3WB01#	
			±0.25pF	GJM1551C1H7R2CB01#				±0.1pF	GJM1551C1H8R3BB01#	
			±0.5pF	GJM1551C1H7R2DB01#				±0.25pF	GJM1551C1H8R3CB01#	
			±1%	GJM1551C1H7R2FB01#				±0.5pF	GJM1551C1H8R3DB01#	
		7.3pF	±0.05pF	GJM1551C1H7R3WB01#			8.4pF	±0.05pF	GJM1551C1H8R4WB01#	
			±0.1pF	GJM1551C1H7R3BB01#				±0.1pF	GJM1551C1H8R4BB01#	
			±0.25pF	GJM1551C1H7R3CB01#				±0.25pF	GJM1551C1H8R4CB01#	
			±0.5pF	GJM1551C1H7R3DB01#				±0.5pF	GJM1551C1H8R4DB01#	
		7.4pF	±1%	GJM1551C1H7R3FB01#			8.5pF	±1%	GJM1551C1H8R4FB01#	
			±0.05pF	GJM1551C1H7R4WB01#				±0.05pF	GJM1551C1H8R5WB01#	
			±0.1pF	GJM1551C1H7R4BB01#				±0.1pF	GJM1551C1H8R5BB01#	
			±0.25pF	GJM1551C1H7R4CB01#				±0.25pF	GJM1551C1H8R5CB01#	
		7.5pF	±0.5pF	GJM1551C1H7R4DB01#			8.6pF	±0.5pF	GJM1551C1H8R5DB01#	
			±1%	GJM1551C1H7R4FB01#				±1%	GJM1551C1H8R5FB01#	
			±0.05pF	GJM1551C1H7R5WB01#				8.7pF	±0.05pF	GJM1551C1H8R6WB01#
			±0.1pF	GJM1551C1H7R5BB01#					±0.1pF	GJM1551C1H8R6BB01#
		±0.25pF	GJM1551C1H7R5CB01#	±0.25pF			GJM1551C1H8R6CB01#			
		±0.5pF	GJM1551C1H7R5DB01#	±0.5pF			GJM1551C1H8R6DB01#			
		7.6pF	±1%	GJM1551C1H7R5FB01#			8.8pF	±1%	GJM1551C1H8R6FB01#	
			±0.05pF	GJM1551C1H7R6WB01#				±0.05pF	GJM1551C1H8R7WB01#	
			±0.1pF	GJM1551C1H7R6BB01#				±0.1pF	GJM1551C1H8R7BB01#	
			±0.25pF	GJM1551C1H7R6CB01#				±0.25pF	GJM1551C1H8R7CB01#	
		7.7pF	±0.5pF	GJM1551C1H7R6DB01#			8.9pF	±0.5pF	GJM1551C1H8R7DB01#	
			±1%	GJM1551C1H7R6FB01#				±1%	GJM1551C1H8R7FB01#	
			±0.05pF	GJM1551C1H7R7WB01#				9.0pF	±0.05pF	GJM1551C1H8R8WB01#
			±0.1pF	GJM1551C1H7R7BB01#					±0.1pF	GJM1551C1H8R8BB01#
		±0.25pF	GJM1551C1H7R7CB01#	±0.25pF			GJM1551C1H8R8CB01#			
		±0.5pF	GJM1551C1H7R7DB01#	±0.5pF			GJM1551C1H8R8DB01#			
		7.8pF	±1%	GJM1551C1H7R7FB01#			9.1pF	±1%	GJM1551C1H8R8FB01#	
			±0.05pF	GJM1551C1H7R8WB01#				±0.05pF	GJM1551C1H8R9WB01#	
			±0.1pF	GJM1551C1H7R8BB01#				±0.1pF	GJM1551C1H8R9BB01#	
			±0.25pF	GJM1551C1H7R8CB01#				±0.25pF	GJM1551C1H8R9CB01#	
		7.9pF	±0.5pF	GJM1551C1H7R8DB01#			9.2pF	±0.5pF	GJM1551C1H8R9DB01#	
			±1%	GJM1551C1H7R8FB01#				±1%	GJM1551C1H8R9FB01#	
			±0.05pF	GJM1551C1H7R9WB01#				9.3pF	±0.05pF	GJM1551C1H8R9WB01#
			±0.1pF	GJM1551C1H7R9BB01#					±0.1pF	GJM1551C1H9R0WB01#
		±0.25pF	GJM1551C1H7R9CB01#	±0.25pF			GJM1551C1H9R0CB01#			
		±0.5pF	GJM1551C1H7R9DB01#	±0.5pF			GJM1551C1H9R0DB01#			
		8.0pF	±1%	GJM1551C1H7R9FB01#			9.9pF	±1%	GJM1551C1H9R0FB01#	
			±0.05pF	GJM1551C1H8R0WB01#				±0.05pF	GJM1551C1H9R1WB01#	
			±0.1pF	GJM1551C1H8R0BB01#				±0.1pF	GJM1551C1H9R1BB01#	
			±0.25pF	GJM1551C1H8R0CB01#				±0.25pF	GJM1551C1H9R1CB01#	
		8.1pF	±0.5pF	GJM1551C1H8R0DB01#			9.9pF	±0.5pF	GJM1551C1H9R1DB01#	
			±1%	GJM1551C1H8R0FB01#				±1%	GJM1551C1H9R1FB01#	
			±0.05pF	GJM1551C1H8R1WB01#				9.9pF	±0.05pF	GJM1551C1H9R2WB01#
			±0.1pF	GJM1551C1H8R1BB01#					±0.1pF	GJM1551C1H9R2BB01#
		±0.25pF	GJM1551C1H8R1CB01#	±0.25pF			GJM1551C1H9R2CB01#			
		±0.5pF	GJM1551C1H8R1DB01#	±0.5pF			GJM1551C1H9R2DB01#			
		8.2pF	±1%	GJM1551C1H8R1FB01#			9.9pF	±1%	GJM1551C1H9R2FB01#	
			±0.05pF	GJM1551C1H8R2WB01#				±0.05pF	GJM1551C1H9R3WB01#	
			±0.1pF	GJM1551C1H8R2BB01#				±0.1pF	GJM1551C1H9R3BB01#	
			±0.25pF	GJM1551C1H8R2CB01#				±0.25pF	GJM1551C1H9R3CB01#	
		8.2pF	±0.5pF	GJM1551C1H8R2DB01#			9.9pF	±0.5pF	GJM1551C1H9R3DB01#	
			±1%	GJM1551C1H8R2FB01#				±0.5pF	GJM1551C1H9R3DB01#	

- GRM
- GR3
- GRJ
- GR4
- GJM
- GQM
- GQ2
- GA2
- GA3
- GA3
- GA3
- GA3
- LL
- LLA
- LLM
- LLR
- NFM
- GJ4
- ZRA
- ZRB
- KRM
- KR3
- GMA
- GMD
- △Caution / Notice

Part number # indicates the package specification code.

GJM Series Temperature Compensating Type High Q Part Number List

(→ 1.0×0.5mm)

Rated Voltage	TC Code	Cap.	Tol.	Part Number	Rated Voltage	TC Code	Cap.	Tol.	Part Number	
50Vdc	CG	9.3pF	±1%	GJM1551C1H9R3FB01#	50Vdc	CG	17pF	±2%	GJM1551C1H170GB01#	
			±0.05pF	GJM1551C1H9R4WB01#				±5%	GJM1551C1H170JB01#	
			±0.1pF	GJM1551C1H9R4BB01#				18pF	±1%	GJM1551C1H180FB01#
			±0.25pF	GJM1551C1H9R4CB01#					±2%	GJM1551C1H180GB01#
			±0.5pF	GJM1551C1H9R4DB01#					±5%	GJM1551C1H180JB01#
		±1%	GJM1551C1H9R4FB01#	19pF			±1%		GJM1551C1H190FB01#	
		±0.05pF	GJM1551C1H9R5WB01#				±2%		GJM1551C1H190GB01#	
		±0.1pF	GJM1551C1H9R5BB01#				±5%	GJM1551C1H190JB01#		
		9.5pF	±0.25pF	GJM1551C1H9R5CB01#			20pF	±1%	GJM1551C1H200FB01#	
			±0.5pF	GJM1551C1H9R5DB01#				±2%	GJM1551C1H200GB01#	
			±1%	GJM1551C1H9R5FB01#				±5%	GJM1551C1H200JB01#	
			9.6pF	±0.05pF				GJM1551C1H9R6WB01#	22pF	±1%
		±0.1pF		GJM1551C1H9R6BB01#			±2%	GJM1551C1H220GB01#		
		±0.25pF		GJM1551C1H9R6CB01#			±5%	GJM1551C1H220JB01#		
		±0.5pF		GJM1551C1H9R6DB01#			24pF	±1%		GJM1551C1H240FB01#
		±1%		GJM1551C1H9R6FB01#				±2%		GJM1551C1H240GB01#
		±5%	GJM1551C1H240JB01#							
		9.7pF	±0.05pF	GJM1551C1H9R7WB01#			27pF	±1%	GJM1551C1H270FB01#	
			±0.1pF	GJM1551C1H9R7BB01#				±2%	GJM1551C1H270GB01#	
			±0.25pF	GJM1551C1H9R7CB01#				±5%	GJM1551C1H270JB01#	
			±0.5pF	GJM1551C1H9R7DB01#				30pF	±1%	GJM1551C1H300FB01#
			±1%	GJM1551C1H9R7FB01#					±2%	GJM1551C1H300GB01#
		±5%	GJM1551C1H300JB01#							
		9.8pF	±0.05pF	GJM1551C1H9R8WB01#			33pF	±1%	GJM1551C1H330FB01#	
			±0.1pF	GJM1551C1H9R8BB01#				±2%	GJM1551C1H330GB01#	
			±0.25pF	GJM1551C1H9R8CB01#				±5%	GJM1551C1H330JB01#	
			±0.5pF	GJM1551C1H9R8DB01#				36pF	±1%	GJM1551C1H360FB01#
			±1%	GJM1551C1H9R8FB01#					±2%	GJM1551C1H360GB01#
		±5%	GJM1551C1H360JB01#							
		9.9pF	±0.05pF	GJM1551C1H9R9WB01#			39pF	±1%	GJM1551C1H390FB01#	
			±0.1pF	GJM1551C1H9R9BB01#				±2%	GJM1551C1H390GB01#	
			±0.25pF	GJM1551C1H9R9CB01#				±5%	GJM1551C1H390JB01#	
			±0.5pF	GJM1551C1H9R9DB01#				43pF	±1%	GJM1551C1H430FB01#
			±1%	GJM1551C1H9R9FB01#					±2%	GJM1551C1H430GB01#
		±5%	GJM1551C1H430JB01#							
		10pF	±1%	GJM1551C1H100FB01#			47pF	±1%	GJM1551C1H470FB01#	
			±2%	GJM1551C1H100GB01#				±2%	GJM1551C1H470GB01#	
			±2.5%	GJM1551C1H100RB01#				±5%	GJM1551C1H470JB01#	
			±5%	GJM1551C1H100JB01#				0.10pF	±0.05pF	GJM1552C1HR10WB01#
		11pF	±1%	GJM1551C1H110FB01#			±0.1pF		GJM1552C1HR10BB01#	
			±2%	GJM1551C1H110GB01#			±20%		GJM1552C1HR10MB01#	
			±5%	GJM1551C1H110JB01#			0.11pF	±0.05pF	GJM1552C1HR11WB01#	
		12pF	±1%	GJM1551C1H120FB01#				±0.1pF	GJM1552C1HR11BB01#	
			±2%	GJM1551C1H120GB01#				±0.05pF	GJM1552C1HR12WB01#	
			±5%	GJM1551C1H120JB01#			±0.1pF	GJM1552C1HR12BB01#		
		13pF	±1%	GJM1551C1H130FB01#			0.12pF	±0.05pF	GJM1552C1HR13WB01#	
			±2%	GJM1551C1H130GB01#				±0.1pF	GJM1552C1HR13BB01#	
			±5%	GJM1551C1H130JB01#				0.13pF	±0.03pF	GJM1552C1HR15RB12#
		14pF	±1%	GJM1551C1H140FB01#			±0.05pF		GJM1552C1HR15WB01#	
			±2%	GJM1551C1H140GB01#			±0.1pF		GJM1552C1HR15BB01#	
			±5%	GJM1551C1H140JB01#			0.15pF	±0.05pF	GJM1552C1HR16WB01#	
		15pF	±1%	GJM1551C1H150FB01#				±0.1pF	GJM1552C1HR16BB01#	
			±2%	GJM1551C1H150GB01#				0.16pF	±0.05pF	GJM1552C1HR18WB01#
			±5%	GJM1551C1H150JB01#			±0.1pF		GJM1552C1HR18BB01#	
		16pF	±1%	GJM1551C1H160FB01#			0.18pF		±0.05pF	GJM1552C1HR18WB01#
			±2%	GJM1551C1H160GB01#				±0.1pF	GJM1552C1HR18BB01#	
			±5%	GJM1551C1H160JB01#				±0.1pF	GJM1552C1HR18BB01#	
		17pF	±1%	GJM1551C1H170FB01#						

Part number # indicates the package specification code.

GRM
 GR3
 GRJ
 GR4
 GJM
 GQM
 GA2
 GA3 GB
 GA3 GD
 GA3 GF
 LLL
 LLA
 LLM
 LLR
 NFM
 GJ4
 ZRA
 ZRB
 KRM
 KR3
 GMA
 GMD
 ⚠Caution /Notice

GJM Series Temperature Compensating Type **High Q** Part Number List

(→ 1.0×0.5mm)

Rated Voltage	TC Code	Cap.	Tol.	Part Number	Rated Voltage	TC Code	Cap.	Tol.	Part Number		
50Vdc	CH	0.20pF	±0.05pF	GJM1552C1HR20WB01#	50Vdc	CH	0.62pF	±0.5pF	GJM1552C1HR62DB01#		
			±0.1pF	GJM1552C1HR20BB01#				0.68pF	±0.05pF	GJM1552C1HR68WB01#	
		0.22pF	±0.05pF	GJM1552C1HR22WB01#			±0.1pF		GJM1552C1HR68BB01#		
			±0.1pF	GJM1552C1HR22BB01#				±0.25pF	GJM1552C1HR68CB01#		
		0.24pF	±0.05pF	GJM1552C1HR24WB01#			±0.5pF		GJM1552C1HR68DB01#		
			±0.1pF	GJM1552C1HR24BB01#				0.70pF	±0.05pF	GJM1552C1HR70WB01#	
		0.25pF	±0.03pF	GJM1552C1HR25RB12#			±0.1pF		GJM1552C1HR70BB01#		
			±0.1pF	GJM1552C1HR25BB01#					±0.25pF	GJM1552C1HR70CB01#	
		0.27pF	±0.05pF	GJM1552C1HR27WB01#			±0.5pF			GJM1552C1HR70DB01#	
			±0.1pF	GJM1552C1HR27BB01#				0.75pF	±0.05pF	GJM1552C1HR75WB01#	
			±0.25pF	GJM1552C1HR27CB01#					±0.1pF	±0.1pF	GJM1552C1HR75BB01#
		0.30pF	±0.05pF	GJM1552C1HR30WB01#			±0.25pF			±0.25pF	GJM1552C1HR75CB01#
			±0.1pF	GJM1552C1HR30BB01#				±0.5pF		±0.5pF	GJM1552C1HR75DB01#
			±0.25pF	GJM1552C1HR30CB01#					0.80pF	±0.05pF	GJM1552C1HR80WB01#
		0.33pF	±0.05pF	GJM1552C1HR33WB01#			±0.1pF			±0.1pF	GJM1552C1HR80BB01#
			±0.1pF	GJM1552C1HR33BB01#				±0.25pF		±0.25pF	GJM1552C1HR80CB01#
			±0.25pF	GJM1552C1HR33CB01#						±0.5pF	±0.5pF
		0.36pF	±0.05pF	GJM1552C1HR36WB01#			±0.05pF		±0.05pF		GJM1552C1HR82WB01#
			±0.1pF	GJM1552C1HR36BB01#				±0.1pF	±0.1pF		GJM1552C1HR82BB01#
			±0.25pF	GJM1552C1HR36CB01#					±0.25pF	±0.25pF	GJM1552C1HR82CB01#
		0.39pF	±0.05pF	GJM1552C1HR39WB01#			±0.5pF			±0.5pF	GJM1552C1HR82DB01#
			±0.1pF	GJM1552C1HR39BB01#				0.85pF		±0.05pF	GJM1552C1HR85WB01#
			±0.25pF	GJM1552C1HR39CB01#					±0.05pF	±0.05pF	GJM1552C1HR90WB01#
		0.40pF	±0.05pF	GJM1552C1HR40WB01#			±0.1pF			±0.1pF	GJM1552C1HR90BB01#
			±0.1pF	GJM1552C1HR40BB01#				±0.25pF		±0.25pF	GJM1552C1HR90CB01#
			±0.25pF	GJM1552C1HR40CB01#					±0.5pF	±0.5pF	GJM1552C1HR90DB01#
		0.43pF	±0.05pF	GJM1552C1HR43WB01#			±0.05pF			±0.05pF	GJM1552C1HR91WB01#
			±0.1pF	GJM1552C1HR43BB01#				±0.1pF		±0.1pF	GJM1552C1HR91BB01#
			±0.25pF	GJM1552C1HR43CB01#					±0.25pF	±0.25pF	GJM1552C1HR91CB01#
		0.45pF	±0.03pF	GJM1552C1HR45RB12#			±0.5pF			±0.5pF	GJM1552C1HR91DB01#
			±0.05pF	GJM1552C1HR45WB01#				0.95pF		±0.05pF	GJM1552C1HR95WB01#
		0.47pF	±0.05pF	GJM1552C1HR47WB01#			±0.05pF		±0.05pF	GJM1552C1H1R0WB01#	
			±0.1pF	GJM1552C1HR47BB01#					±0.1pF	±0.1pF	GJM1552C1H1R0BB01#
			±0.25pF	GJM1552C1HR47CB01#				±0.25pF		±0.25pF	GJM1552C1H1R0CB01#
		0.50pF	±0.03pF	GJM1552C1HR50RB12#			±0.5pF			±0.5pF	GJM1552C1H1R0DB01#
			±0.05pF	GJM1552C1HR50WB01#					±5%	GJM1552C1H1R0JB01#	
			±0.1pF	GJM1552C1HR50BB01#				1.1pF		±0.05pF	GJM1552C1H1R1WB01#
			±0.25pF	GJM1552C1HR50CB01#						±0.1pF	±0.1pF
		±0.5pF	GJM1552C1HR50DB01#	±0.25pF			±0.25pF				GJM1552C1H1R1CB01#
		0.51pF	±0.05pF				GJM1552C1HR51WB01#		±0.5pF		±0.5pF
			±0.1pF				GJM1552C1HR51BB01#	±5%			GJM1552C1H1R1JB01#
			±0.25pF				GJM1552C1HR51CB01#			1.2pF	±0.05pF
			±0.5pF	GJM1552C1HR51DB01#			±0.1pF				±0.1pF
		0.56pF	±0.05pF	GJM1552C1HR56WB01#					±0.25pF		±0.25pF
			±0.1pF	GJM1552C1HR56BB01#				±0.5pF			±0.5pF
			±0.25pF	GJM1552C1HR56CB01#						±5%	GJM1552C1H1R2JB01#
			±0.5pF	GJM1552C1HR56DB01#			1.3pF				±0.05pF
		0.60pF	±0.05pF	GJM1552C1HR60WB01#					±0.1pF		±0.1pF
±0.1pF	GJM1552C1HR60BB01#		±0.25pF	±0.25pF	GJM1552C1H1R3CB01#						
±0.25pF	GJM1552C1HR60CB01#			±0.5pF	±0.5pF	GJM1552C1H1R3DB01#					
±0.5pF	GJM1552C1HR60DB01#				±5%	GJM1552C1H1R3JB01#					
0.62pF	±0.05pF	GJM1552C1HR62WB01#				±0.05pF	±0.05pF	GJM1552C1H1R4WB01#			
	±0.1pF	GJM1552C1HR62BB01#	±0.1pF				±0.1pF	GJM1552C1H1R4BB01#			
	±0.25pF	GJM1552C1HR62CB01#		±0.25pF			±0.25pF	GJM1552C1H1R4CB01#			

- GRM
- GR3
- GRJ
- GR4
- GJM
- GQM
- GOM
- GA2
- GA3 GB
- GA3 GD
- GA3 GF
- LLL
- LLA
- LLM
- LLR
- NFM
- GJ4
- ZRA
- ZRB
- KRM
- KR3
- GMA
- GMD
- ⚠Caution /Notice

Part number # indicates the package specification code.

GJM Series Temperature Compensating Type High Q Part Number List

(→ 1.0×0.5mm)

Rated Voltage	TC Code	Cap.	Tol.	Part Number	Rated Voltage	TC Code	Cap.	Tol.	Part Number
50Vdc	CH	1.4pF	±0.5pF	GJM1552C1H1R4DB01#	50Vdc	CH	2.5pF	±0.25pF	GJM1552C1H2R5CB01#
			±5%	GJM1552C1H1R4JB01#				±0.5pF	GJM1552C1H2R5DB01#
		1.5pF	±0.05pF	GJM1552C1H1R5WB01#			±2%	GJM1552C1H2R5GB01#	
			±0.1pF	GJM1552C1H1R5BB01#			2.6pF	±0.05pF	GJM1552C1H2R6WB01#
			±0.25pF	GJM1552C1H1R5CB01#				±0.1pF	GJM1552C1H2R6BB01#
			±0.5pF	GJM1552C1H1R5DB01#				±0.25pF	GJM1552C1H2R6CB01#
			±5%	GJM1552C1H1R5JB01#				±0.5pF	GJM1552C1H2R6DB01#
				±2%				GJM1552C1H2R6GB01#	
		1.6pF	±0.05pF	GJM1552C1H1R6WB01#			2.7pF	±0.05pF	GJM1552C1H2R7WB01#
			±0.1pF	GJM1552C1H1R6BB01#				±0.1pF	GJM1552C1H2R7BB01#
			±0.25pF	GJM1552C1H1R6CB01#				±0.25pF	GJM1552C1H2R7CB01#
			±0.5pF	GJM1552C1H1R6DB01#				±0.5pF	GJM1552C1H2R7DB01#
			±5%	GJM1552C1H1R6JB01#				±2%	GJM1552C1H2R7GB01#
		1.7pF	±0.05pF	GJM1552C1H1R7WB01#			2.8pF	±0.05pF	GJM1552C1H2R8WB01#
			±0.1pF	GJM1552C1H1R7BB01#				±0.1pF	GJM1552C1H2R8BB01#
			±0.25pF	GJM1552C1H1R7CB01#				±0.25pF	GJM1552C1H2R8CB01#
			±0.5pF	GJM1552C1H1R7DB01#				±0.5pF	GJM1552C1H2R8DB01#
			±5%	GJM1552C1H1R7JB01#				±2%	GJM1552C1H2R8GB01#
		1.8pF	±0.05pF	GJM1552C1H1R8WB01#			2.9pF	±0.05pF	GJM1552C1H2R9WB01#
			±0.1pF	GJM1552C1H1R8BB01#				±0.1pF	GJM1552C1H2R9BB01#
			±0.25pF	GJM1552C1H1R8CB01#				±0.25pF	GJM1552C1H2R9CB01#
			±0.5pF	GJM1552C1H1R8DB01#				±0.5pF	GJM1552C1H2R9DB01#
			±5%	GJM1552C1H1R8JB01#				±2%	GJM1552C1H2R9GB01#
		1.9pF	±0.05pF	GJM1552C1H1R9WB01#			3.0pF	±0.05pF	GJM1552C1H3R0WB01#
			±0.1pF	GJM1552C1H1R9BB01#				±0.1pF	GJM1552C1H3R0BB01#
			±0.25pF	GJM1552C1H1R9CB01#				±0.25pF	GJM1552C1H3R0CB01#
			±0.5pF	GJM1552C1H1R9DB01#				±0.5pF	GJM1552C1H3R0DB01#
			±5%	GJM1552C1H1R9JB01#				±2%	GJM1552C1H3R0GB01#
		2.0pF	±0.05pF	GJM1552C1H2R0WB01#			3.1pF	±0.05pF	GJM1552C1H3R1WB01#
			±0.1pF	GJM1552C1H2R0BB01#				±0.1pF	GJM1552C1H3R1BB01#
			±0.25pF	GJM1552C1H2R0CB01#				±0.25pF	GJM1552C1H3R1CB01#
			±0.5pF	GJM1552C1H2R0DB01#				±0.5pF	GJM1552C1H3R1DB01#
			±2%	GJM1552C1H2R0GB01#				±2%	GJM1552C1H3R1GB01#
		2.1pF	±0.05pF	GJM1552C1H2R1WB01#			3.2pF	±0.05pF	GJM1552C1H3R2WB01#
			±0.1pF	GJM1552C1H2R1BB01#				±0.1pF	GJM1552C1H3R2BB01#
			±0.25pF	GJM1552C1H2R1CB01#				±0.25pF	GJM1552C1H3R2CB01#
			±0.5pF	GJM1552C1H2R1DB01#				±0.5pF	GJM1552C1H3R2DB01#
			±2%	GJM1552C1H2R1GB01#				±2%	GJM1552C1H3R2GB01#
		2.2pF	±0.05pF	GJM1552C1H2R2WB01#			3.3pF	±0.05pF	GJM1552C1H3R3WB01#
			±0.1pF	GJM1552C1H2R2BB01#				±0.1pF	GJM1552C1H3R3BB01#
			±0.25pF	GJM1552C1H2R2CB01#				±0.25pF	GJM1552C1H3R3CB01#
			±0.5pF	GJM1552C1H2R2DB01#				±0.5pF	GJM1552C1H3R3DB01#
			±2%	GJM1552C1H2R2GB01#				±2%	GJM1552C1H3R3GB01#
		2.3pF	±0.05pF	GJM1552C1H2R3WB01#			3.4pF	±0.05pF	GJM1552C1H3R4WB01#
			±0.1pF	GJM1552C1H2R3BB01#				±0.1pF	GJM1552C1H3R4BB01#
			±0.25pF	GJM1552C1H2R3CB01#				±0.25pF	GJM1552C1H3R4CB01#
			±0.5pF	GJM1552C1H2R3DB01#				±0.5pF	GJM1552C1H3R4DB01#
			±2%	GJM1552C1H2R3GB01#				±2%	GJM1552C1H3R4GB01#
		2.4pF	±0.05pF	GJM1552C1H2R4WB01#			3.5pF	±0.05pF	GJM1552C1H3R5WB01#
			±0.1pF	GJM1552C1H2R4BB01#				±0.1pF	GJM1552C1H3R5BB01#
±0.25pF	GJM1552C1H2R4CB01#		±0.25pF	GJM1552C1H3R5CB01#					
±0.5pF	GJM1552C1H2R4DB01#		±0.5pF	GJM1552C1H3R5DB01#					
±2%	GJM1552C1H2R4GB01#		±2%	GJM1552C1H3R5GB01#					
2.5pF	±0.05pF	GJM1552C1H2R5WB01#	3.6pF	±0.05pF	GJM1552C1H3R6WB01#				
	±0.1pF	GJM1552C1H2R5BB01#							

Part number # indicates the package specification code.

- GRM
- GR3
- GRJ
- GR4
- GJM
- GQM
- GQ2
- GA2
- GA3
- GA3
- GA3
- GA3
- LL
- LLA
- LLM
- LLR
- NFM
- GJ4
- ZRA
- ZRB
- KRM
- KR3
- GMA
- GMD
- ⚠Caution / Notice

GJM Series Temperature Compensating Type High Q Part Number List

(→ 1.0×0.5mm)

Rated Voltage	TC Code	Cap.	Tol.	Part Number	Rated Voltage	TC Code	Cap.	Tol.	Part Number	
50Vdc	CH	3.6pF	±0.1pF	GJM1552C1H3R6BB01#	50Vdc	CH	4.7pF	±0.05pF	GJM1552C1H4R7WB01#	
			±0.25pF	GJM1552C1H3R6CB01#				±0.1pF	GJM1552C1H4R7BB01#	
			±0.5pF	GJM1552C1H3R6DB01#				±0.25pF	GJM1552C1H4R7CB01#	
			±2%	GJM1552C1H3R6GB01#				±0.5pF	GJM1552C1H4R7DB01#	
		3.7pF	±0.05pF	GJM1552C1H3R7WB01#			4.8pF	±0.05pF	GJM1552C1H4R8WB01#	
			±0.1pF	GJM1552C1H3R7BB01#				±0.1pF	GJM1552C1H4R8BB01#	
			±0.25pF	GJM1552C1H3R7CB01#				±0.25pF	GJM1552C1H4R8CB01#	
			±0.5pF	GJM1552C1H3R7DB01#				±0.5pF	GJM1552C1H4R8DB01#	
		3.8pF	±2%	GJM1552C1H3R7GB01#			4.9pF	±0.05pF	GJM1552C1H4R9WB01#	
			±0.05pF	GJM1552C1H3R8WB01#				±0.1pF	GJM1552C1H4R9BB01#	
			±0.1pF	GJM1552C1H3R8BB01#				±0.25pF	GJM1552C1H4R9CB01#	
			±0.25pF	GJM1552C1H3R8CB01#				±0.5pF	GJM1552C1H4R9DB01#	
		3.9pF	±0.5pF	GJM1552C1H3R8DB01#			5.0pF	±2%	GJM1552C1H4R9GB01#	
			±0.05pF	GJM1552C1H3R9WB01#				±0.05pF	GJM1552C1H5R0WB01#	
			±0.1pF	GJM1552C1H3R9BB01#				±0.1pF	GJM1552C1H5R0BB01#	
			±0.25pF	GJM1552C1H3R9CB01#				±0.25pF	GJM1552C1H5R0CB01#	
		4.0pF	±0.5pF	GJM1552C1H3R9DB01#			5.1pF	±0.5pF	GJM1552C1H5R0DB01#	
			±2%	GJM1552C1H3R9GB01#				±1%	GJM1552C1H5R0FB01#	
			±0.05pF	GJM1552C1H4R0WB01#				5.2pF	±0.05pF	GJM1552C1H5R1WB01#
			±0.1pF	GJM1552C1H4R0BB01#					±0.1pF	GJM1552C1H5R1BB01#
		±0.25pF	GJM1552C1H4R0CB01#	±0.25pF			GJM1552C1H5R1CB01#			
		±0.5pF	GJM1552C1H4R0DB01#	±0.5pF			GJM1552C1H5R1DB01#			
		4.1pF	±2%	GJM1552C1H4R0GB01#			5.3pF	±1%	GJM1552C1H5R1FB01#	
			±0.05pF	GJM1552C1H4R1WB01#				5.4pF	±0.05pF	GJM1552C1H5R2WB01#
			±0.1pF	GJM1552C1H4R1BB01#					±0.1pF	GJM1552C1H5R2BB01#
			±0.25pF	GJM1552C1H4R1CB01#					±0.25pF	GJM1552C1H5R2CB01#
		±0.5pF	GJM1552C1H4R1DB01#	±0.5pF			GJM1552C1H5R2DB01#			
		4.2pF	±2%	GJM1552C1H4R1GB01#			5.5pF	±1%	GJM1552C1H5R2FB01#	
			±0.05pF	GJM1552C1H4R2WB01#				5.6pF	±0.05pF	GJM1552C1H5R3WB01#
			±0.1pF	GJM1552C1H4R2BB01#					±0.1pF	GJM1552C1H5R3BB01#
			±0.25pF	GJM1552C1H4R2CB01#					±0.25pF	GJM1552C1H5R3CB01#
		±0.5pF	GJM1552C1H4R2DB01#	±0.5pF			GJM1552C1H5R3DB01#			
		4.3pF	±2%	GJM1552C1H4R2GB01#			5.7pF	±1%	GJM1552C1H5R3FB01#	
			±0.05pF	GJM1552C1H4R3WB01#				5.8pF	±0.05pF	GJM1552C1H5R4WB01#
			±0.1pF	GJM1552C1H4R3BB01#					±0.1pF	GJM1552C1H5R4BB01#
			±0.25pF	GJM1552C1H4R3CB01#					±0.25pF	GJM1552C1H5R4CB01#
		±0.5pF	GJM1552C1H4R3DB01#	±0.5pF			GJM1552C1H5R4DB01#			
		4.4pF	±2%	GJM1552C1H4R3GB01#			5.9pF	±1%	GJM1552C1H5R4FB01#	
			±0.05pF	GJM1552C1H4R4WB01#				6.0pF	±0.05pF	GJM1552C1H5R5WB01#
			±0.1pF	GJM1552C1H4R4BB01#					±0.1pF	GJM1552C1H5R5BB01#
			±0.25pF	GJM1552C1H4R4CB01#					±0.25pF	GJM1552C1H5R5CB01#
		±0.5pF	GJM1552C1H4R4DB01#	±0.5pF			GJM1552C1H5R5DB01#			
		4.5pF	±2%	GJM1552C1H4R4GB01#			6.1pF	±1%	GJM1552C1H5R5FB01#	
			±0.05pF	GJM1552C1H4R5WB01#				6.2pF	±0.05pF	GJM1552C1H5R6WB01#
			±0.1pF	GJM1552C1H4R5BB01#					±0.1pF	GJM1552C1H5R6BB01#
			±0.25pF	GJM1552C1H4R5CB01#					±0.25pF	GJM1552C1H5R6CB01#
		±0.5pF	GJM1552C1H4R5DB01#	±0.5pF			GJM1552C1H5R6DB01#			
		4.6pF	±2%	GJM1552C1H4R5GB01#			6.3pF	±1%	GJM1552C1H5R6FB01#	
±0.05pF	GJM1552C1H4R6WB01#		6.4pF	±0.05pF	GJM1552C1H5R7WB01#					
±0.1pF	GJM1552C1H4R6BB01#			±0.1pF	GJM1552C1H5R7BB01#					
±0.25pF	GJM1552C1H4R6CB01#			±0.25pF	GJM1552C1H5R7CB01#					
±0.5pF	GJM1552C1H4R6DB01#	±0.5pF		GJM1552C1H5R7DB01#						
4.7pF	±2%	GJM1552C1H4R6GB01#	6.5pF	±1%	GJM1552C1H5R7FB01#					

- GRM
- GR3
- GRJ
- GR4
- GJM
- GQM
- GA2
- GA3 GB
- GA3 GD
- GA3 GF
- LLL
- LLA
- LLM
- LLR
- NFM
- GJ4
- ZRA
- ZRB
- KRM
- KR3
- GMA
- GMD
- ⚠Caution /Notice

Part number # indicates the package specification code.

GJM Series Temperature Compensating Type High Q Part Number List

(→ 1.0×0.5mm)

Rated Voltage	TC Code	Cap.	Tol.	Part Number	Rated Voltage	TC Code	Cap.	Tol.	Part Number	
50Vdc	CH	5.7pF	±1%	GJM1552C1H5R7FB01#	50Vdc	CH	6.8pF	±0.5pF	GJM1552C1H6R8DB01#	
			±1%	GJM1552C1H5R8WB01#				±1%	GJM1552C1H6R8FB01#	
		5.8pF	±0.05pF	GJM1552C1H5R8WB01#			6.9pF	±0.05pF	GJM1552C1H6R9WB01#	
			±0.1pF	GJM1552C1H5R8BB01#				±0.1pF	GJM1552C1H6R9BB01#	
			±0.25pF	GJM1552C1H5R8CB01#				±0.25pF	GJM1552C1H6R9CB01#	
			±0.5pF	GJM1552C1H5R8DB01#				±0.5pF	GJM1552C1H6R9DB01#	
		5.9pF	±1%	GJM1552C1H5R8FB01#			7.0pF	±1%	GJM1552C1H6R9FB01#	
			±0.05pF	GJM1552C1H5R9WB01#				±0.05pF	GJM1552C1H7R0WB01#	
			±0.1pF	GJM1552C1H5R9BB01#				±0.1pF	GJM1552C1H7R0BB01#	
			±0.25pF	GJM1552C1H5R9CB01#				±0.25pF	GJM1552C1H7R0CB01#	
		6.0pF	±0.5pF	GJM1552C1H5R9DB01#			7.1pF	±0.5pF	GJM1552C1H7R0DB01#	
			±1%	GJM1552C1H5R9FB01#				±1%	GJM1552C1H7R0FB01#	
			±0.05pF	GJM1552C1H6R0WB01#				7.2pF	±0.05pF	GJM1552C1H7R1WB01#
			±0.1pF	GJM1552C1H6R0BB01#					±0.1pF	GJM1552C1H7R1BB01#
		±0.25pF	GJM1552C1H6R0CB01#	±0.25pF			GJM1552C1H7R1CB01#			
		±0.5pF	GJM1552C1H6R0DB01#	±0.5pF			GJM1552C1H7R1DB01#			
		6.1pF	±1%	GJM1552C1H6R0FB01#			7.3pF	±1%	GJM1552C1H7R1FB01#	
			±0.05pF	GJM1552C1H6R1WB01#				7.4pF	±0.05pF	GJM1552C1H7R2WB01#
			±0.1pF	GJM1552C1H6R1BB01#					±0.1pF	GJM1552C1H7R2BB01#
			±0.25pF	GJM1552C1H6R1CB01#					±0.25pF	GJM1552C1H7R2CB01#
		±0.5pF	GJM1552C1H6R1DB01#	±0.5pF			GJM1552C1H7R2DB01#			
		6.2pF	±1%	GJM1552C1H6R1FB01#			7.5pF	±1%	GJM1552C1H7R2FB01#	
			±0.05pF	GJM1552C1H6R2WB01#				7.6pF	±0.05pF	GJM1552C1H7R3WB01#
			±0.1pF	GJM1552C1H6R2BB01#					±0.1pF	GJM1552C1H7R3BB01#
			±0.25pF	GJM1552C1H6R2CB01#					±0.25pF	GJM1552C1H7R3CB01#
		±0.5pF	GJM1552C1H6R2DB01#	±0.5pF			GJM1552C1H7R3DB01#			
		6.3pF	±1%	GJM1552C1H6R2FB01#			7.7pF	±1%	GJM1552C1H7R3FB01#	
			±0.05pF	GJM1552C1H6R3WB01#				7.8pF	±0.05pF	GJM1552C1H7R4WB01#
			±0.1pF	GJM1552C1H6R3BB01#					±0.1pF	GJM1552C1H7R4BB01#
			±0.25pF	GJM1552C1H6R3CB01#					±0.25pF	GJM1552C1H7R4CB01#
		±0.5pF	GJM1552C1H6R3DB01#	±0.5pF			GJM1552C1H7R4DB01#			
		6.4pF	±1%	GJM1552C1H6R3FB01#			7.9pF	±1%	GJM1552C1H7R4FB01#	
			±0.05pF	GJM1552C1H6R4WB01#				7.9pF	±0.05pF	GJM1552C1H7R9WB01#
			±0.1pF	GJM1552C1H6R4BB01#					±0.1pF	GJM1552C1H7R9BB01#
			±0.25pF	GJM1552C1H6R4CB01#					±0.25pF	GJM1552C1H7R9CB01#
		±0.5pF	GJM1552C1H6R4DB01#	±0.5pF			GJM1552C1H7R9DB01#			
		6.5pF	±1%	GJM1552C1H6R4FB01#			7.9pF	±1%	GJM1552C1H7R9FB01#	
			±0.05pF	GJM1552C1H6R5WB01#				7.9pF	±0.05pF	GJM1552C1H7R9WB01#
			±0.1pF	GJM1552C1H6R5BB01#					±0.1pF	GJM1552C1H7R9BB01#
			±0.25pF	GJM1552C1H6R5CB01#					±0.25pF	GJM1552C1H7R9CB01#
		±0.5pF	GJM1552C1H6R5DB01#	±0.5pF			GJM1552C1H7R9DB01#			
		6.6pF	±1%	GJM1552C1H6R5FB01#			7.9pF	±1%	GJM1552C1H7R9FB01#	
			±0.05pF	GJM1552C1H6R6WB01#				7.9pF	±0.05pF	GJM1552C1H7R9WB01#
			±0.1pF	GJM1552C1H6R6BB01#					±0.1pF	GJM1552C1H7R9BB01#
			±0.25pF	GJM1552C1H6R6CB01#					±0.25pF	GJM1552C1H7R9CB01#
		±0.5pF	GJM1552C1H6R6DB01#	±0.5pF			GJM1552C1H7R9DB01#			
		6.7pF	±1%	GJM1552C1H6R6FB01#			7.9pF	±1%	GJM1552C1H7R9FB01#	
			±0.05pF	GJM1552C1H6R7WB01#				7.9pF	±0.05pF	GJM1552C1H7R9WB01#
±0.1pF	GJM1552C1H6R7BB01#		±0.1pF	GJM1552C1H7R9BB01#						
±0.25pF	GJM1552C1H6R7CB01#		±0.25pF	GJM1552C1H7R9CB01#						
±0.5pF	GJM1552C1H6R7DB01#	±0.5pF	GJM1552C1H7R9DB01#							
6.8pF	±1%	GJM1552C1H6R7FB01#	7.9pF	±1%	GJM1552C1H7R9FB01#					
	±0.05pF	GJM1552C1H6R8WB01#		7.9pF	±0.05pF	GJM1552C1H7R9WB01#				
	±0.1pF	GJM1552C1H6R8BB01#			±0.1pF	GJM1552C1H7R9BB01#				
	±0.25pF	GJM1552C1H6R8CB01#			±0.25pF	GJM1552C1H7R9CB01#				
±0.5pF	GJM1552C1H6R8DB01#	±0.5pF	GJM1552C1H7R9DB01#							

Part number # indicates the package specification code.

- GRM
- GR3
- GRJ
- GR4
- GJM
- GQM
- GQ2
- GA2
- GA3
- GA3
- GA3
- GA3
- LL
- LLA
- LLM
- LLR
- NFM
- GJ4
- ZRA
- ZRB
- KRM
- KR3
- GMA
- GMD
- △Caution / Notice

GJM Series Temperature Compensating Type High Q Part Number List

(→ 1.0×0.5mm)

Rated Voltage	TC Code	Cap.	Tol.	Part Number	Rated Voltage	TC Code	Cap.	Tol.	Part Number
50Vdc	CH	7.9pF	±0.25pF	GJM1552C1H7R9CB01#	50Vdc	CH	9.0pF	±0.1pF	GJM1552C1H9R0BB01#
			±0.5pF	GJM1552C1H7R9DB01#				±0.25pF	GJM1552C1H9R0CB01#
			±1%	GJM1552C1H7R9FB01#				±0.5pF	GJM1552C1H9R0DB01#
		8.0pF	±0.05pF	GJM1552C1H8R0WB01#			±1%	GJM1552C1H9R0FB01#	
			±0.1pF	GJM1552C1H8R0BB01#			9.1pF	±0.05pF	GJM1552C1H9R1WB01#
			±0.25pF	GJM1552C1H8R0CB01#				±0.1pF	GJM1552C1H9R1BB01#
			±0.5pF	GJM1552C1H8R0DB01#				±0.25pF	GJM1552C1H9R1CB01#
		±1%	GJM1552C1H8R0FB01#	±0.5pF				GJM1552C1H9R1DB01#	
		8.1pF	±0.05pF	GJM1552C1H8R1WB01#			±1%	GJM1552C1H9R1FB01#	
			±0.1pF	GJM1552C1H8R1BB01#			9.2pF	±0.05pF	GJM1552C1H9R2WB01#
			±0.25pF	GJM1552C1H8R1CB01#				±0.1pF	GJM1552C1H9R2BB01#
			±0.5pF	GJM1552C1H8R1DB01#				±0.25pF	GJM1552C1H9R2CB01#
			±1%	GJM1552C1H8R1FB01#				±0.5pF	GJM1552C1H9R2DB01#
		±1%	GJM1552C1H8R1FB01#	±1%				GJM1552C1H9R2FB01#	
		8.2pF	±0.05pF	GJM1552C1H8R2WB01#			9.3pF	±0.05pF	GJM1552C1H9R3WB01#
			±0.1pF	GJM1552C1H8R2BB01#				±0.1pF	GJM1552C1H9R3BB01#
			±0.25pF	GJM1552C1H8R2CB01#				±0.25pF	GJM1552C1H9R3CB01#
			±0.5pF	GJM1552C1H8R2DB01#				±0.5pF	GJM1552C1H9R3DB01#
		8.3pF	±0.05pF	GJM1552C1H8R3WB01#			±1%	GJM1552C1H9R3FB01#	
			±0.1pF	GJM1552C1H8R3BB01#			9.4pF	±0.05pF	GJM1552C1H9R4WB01#
			±0.25pF	GJM1552C1H8R3CB01#				±0.1pF	GJM1552C1H9R4BB01#
			±0.5pF	GJM1552C1H8R3DB01#				±0.25pF	GJM1552C1H9R4CB01#
			±1%	GJM1552C1H8R3FB01#				±0.5pF	GJM1552C1H9R4DB01#
		±1%	GJM1552C1H8R3FB01#	±1%				GJM1552C1H9R4FB01#	
		8.4pF	±0.05pF	GJM1552C1H8R4WB01#			9.5pF	±0.05pF	GJM1552C1H9R5WB01#
			±0.1pF	GJM1552C1H8R4BB01#				±0.1pF	GJM1552C1H9R5BB01#
			±0.25pF	GJM1552C1H8R4CB01#				±0.25pF	GJM1552C1H9R5CB01#
			±0.5pF	GJM1552C1H8R4DB01#				±0.5pF	GJM1552C1H9R5DB01#
			±1%	GJM1552C1H8R4FB01#				±1%	GJM1552C1H9R5FB01#
		8.5pF	±0.05pF	GJM1552C1H8R5WB01#			9.6pF	±0.05pF	GJM1552C1H9R6WB01#
			±0.1pF	GJM1552C1H8R5BB01#				±0.1pF	GJM1552C1H9R6BB01#
			±0.25pF	GJM1552C1H8R5CB01#				±0.25pF	GJM1552C1H9R6CB01#
			±0.5pF	GJM1552C1H8R5DB01#				±0.5pF	GJM1552C1H9R6DB01#
			±1%	GJM1552C1H8R5FB01#				±1%	GJM1552C1H9R6FB01#
		8.6pF	±0.05pF	GJM1552C1H8R6WB01#			9.7pF	±0.05pF	GJM1552C1H9R7WB01#
			±0.1pF	GJM1552C1H8R6BB01#				±0.1pF	GJM1552C1H9R7BB01#
			±0.25pF	GJM1552C1H8R6CB01#				±0.25pF	GJM1552C1H9R7CB01#
			±0.5pF	GJM1552C1H8R6DB01#				±0.5pF	GJM1552C1H9R7DB01#
			±1%	GJM1552C1H8R6FB01#				±1%	GJM1552C1H9R7FB01#
		8.7pF	±0.05pF	GJM1552C1H8R7WB01#			9.8pF	±0.05pF	GJM1552C1H9R8WB01#
			±0.1pF	GJM1552C1H8R7BB01#				±0.1pF	GJM1552C1H9R8BB01#
			±0.25pF	GJM1552C1H8R7CB01#				±0.25pF	GJM1552C1H9R8CB01#
			±0.5pF	GJM1552C1H8R7DB01#				±0.5pF	GJM1552C1H9R8DB01#
			±1%	GJM1552C1H8R7FB01#				±1%	GJM1552C1H9R8FB01#
		8.8pF	±0.05pF	GJM1552C1H8R8WB01#			9.9pF	±0.05pF	GJM1552C1H9R9WB01#
			±0.1pF	GJM1552C1H8R8BB01#				±0.1pF	GJM1552C1H9R9BB01#
			±0.25pF	GJM1552C1H8R8CB01#				±0.25pF	GJM1552C1H9R9CB01#
			±0.5pF	GJM1552C1H8R8DB01#				±0.5pF	GJM1552C1H9R9DB01#
			±1%	GJM1552C1H8R8FB01#				±1%	GJM1552C1H9R9FB01#
		8.9pF	±0.05pF	GJM1552C1H8R9WB01#			10pF	±1%	GJM1552C1H100FB01#
			±0.1pF	GJM1552C1H8R9BB01#				±2%	GJM1552C1H100GB01#
			±0.25pF	GJM1552C1H8R9CB01#				±2.5%	GJM1552C1H100RB01#
			±0.5pF	GJM1552C1H8R9DB01#				±5%	GJM1552C1H100JB01#
			±1%	GJM1552C1H8R9FB01#				±1%	GJM1552C1H110FB01#
9.0pF	±0.05pF	GJM1552C1H9R0WB01#							

- GRM
- GR3
- GRJ
- GR4
- GJM
- GQM
- GQ2
- GA2
- GA3
- GA3
- GA3
- GA3
- LL
- LLA
- LLM
- LLR
- NFM
- GJ4
- ZRA
- ZRB
- KRM
- KR3
- GMA
- GMD
- △Caution / Notice

Part number # indicates the package specification code.

GJM Series Temperature Compensating Type High Q Part Number List

(→ 1.0×0.5mm)

Rated Voltage	TC Code	Cap.	Tol.	Part Number	Rated Voltage	TC Code	Cap.	Tol.	Part Number	
50Vdc	CH	11pF	±2%	GJM1552C1H110GB01#	50Vdc	CH	47pF	±2%	GJM1552C1H470GB01#	
			±5%	GJM1552C1H110JB01#				±5%	GJM1552C1H470JB01#	
		12pF	±1%	GJM1552C1H120FB01#		CJ	2.1pF	±0.05pF	GJM1553C1H2R1WB01#	
			±2%	GJM1552C1H120GB01#				±0.1pF	GJM1553C1H2R1BB01#	
			±5%	GJM1552C1H120JB01#				±0.25pF	GJM1553C1H2R1CB01#	
		13pF	±1%	GJM1552C1H130FB01#				±0.5pF	GJM1553C1H2R1DB01#	
			±2%	GJM1552C1H130GB01#				±2%	GJM1553C1H2R1GB01#	
			±5%	GJM1552C1H130JB01#				2.2pF	±0.05pF	GJM1553C1H2R2WB01#
		±1%	GJM1552C1H140FB01#	±0.1pF					GJM1553C1H2R2BB01#	
		±2%	GJM1552C1H140GB01#	±0.25pF					GJM1553C1H2R2CB01#	
		14pF	±2%	GJM1552C1H140GB01#				±0.5pF	GJM1553C1H2R2DB01#	
			±5%	GJM1552C1H140JB01#				±2%	GJM1553C1H2R2GB01#	
			15pF	±1%				GJM1552C1H150FB01#	2.3pF	±0.05pF
		±2%		GJM1552C1H150GB01#				±0.1pF		GJM1553C1H2R3BB01#
		±5%		GJM1552C1H150JB01#			±0.25pF	GJM1553C1H2R3CB01#		
		16pF	±1%	GJM1552C1H160FB01#			±0.5pF	GJM1553C1H2R3DB01#		
			±2%	GJM1552C1H160GB01#			±2%	GJM1553C1H2R3GB01#		
			±5%	GJM1552C1H160JB01#			2.4pF	±0.05pF		GJM1553C1H2R4WB01#
		±1%	GJM1552C1H170FB01#	±0.1pF				GJM1553C1H2R4BB01#		
		±2%	GJM1552C1H170GB01#	±0.25pF				GJM1553C1H2R4CB01#		
		17pF	±2%	GJM1552C1H170GB01#			±0.5pF	GJM1553C1H2R4DB01#		
			±5%	GJM1552C1H170JB01#			±2%	GJM1553C1H2R4GB01#		
			18pF	±1%			GJM1552C1H180FB01#	2.5pF		±0.05pF
		±2%		GJM1552C1H180GB01#			±0.1pF			GJM1553C1H2R5BB01#
		±5%		GJM1552C1H180JB01#			±0.25pF		GJM1553C1H2R5CB01#	
		19pF	±1%	GJM1552C1H190FB01#			±0.5pF		GJM1553C1H2R5DB01#	
			±2%	GJM1552C1H190GB01#			±2%		GJM1553C1H2R5GB01#	
			±5%	GJM1552C1H190JB01#			2.6pF		±0.05pF	GJM1553C1H2R6WB01#
		±1%	GJM1552C1H200FB01#	±0.1pF					GJM1553C1H2R6BB01#	
		±2%	GJM1552C1H200GB01#	±0.25pF					GJM1553C1H2R6CB01#	
		20pF	±2%	GJM1552C1H200GB01#			±0.5pF		GJM1553C1H2R6DB01#	
			±5%	GJM1552C1H200JB01#			±2%		GJM1553C1H2R6GB01#	
			22pF	±1%			GJM1552C1H220FB01#		2.7pF	±0.05pF
		±2%		GJM1552C1H220GB01#			±0.1pF			GJM1553C1H2R7BB01#
		±5%		GJM1552C1H220JB01#			±0.25pF	GJM1553C1H2R7CB01#		
		24pF	±1%	GJM1552C1H240FB01#			±0.5pF	GJM1553C1H2R7DB01#		
			±2%	GJM1552C1H240GB01#			±2%	GJM1553C1H2R7GB01#		
			±5%	GJM1552C1H240JB01#			2.8pF	±0.05pF		GJM1553C1H2R8WB01#
		±1%	GJM1552C1H270FB01#	±0.1pF				GJM1553C1H2R8BB01#		
		±2%	GJM1552C1H270GB01#	±0.25pF				GJM1553C1H2R8CB01#		
		27pF	±2%	GJM1552C1H270GB01#			±0.5pF	GJM1553C1H2R8DB01#		
			±5%	GJM1552C1H270JB01#			±2%	GJM1553C1H2R8GB01#		
			30pF	±1%			GJM1552C1H300FB01#	2.9pF		±0.05pF
		±2%		GJM1552C1H300GB01#			±0.1pF			GJM1553C1H2R9BB01#
		±5%		GJM1552C1H300JB01#			±0.25pF		GJM1553C1H2R9CB01#	
		33pF	±1%	GJM1552C1H330FB01#			±0.5pF		GJM1553C1H2R9DB01#	
			±2%	GJM1552C1H330GB01#			±2%		GJM1553C1H2R9GB01#	
			±5%	GJM1552C1H330JB01#			3.0pF		±0.05pF	GJM1553C1H3R0WB01#
±1%	GJM1552C1H360FB01#	±0.1pF	GJM1553C1H3R0BB01#							
±2%	GJM1552C1H360GB01#	±0.25pF	GJM1553C1H3R0CB01#							
36pF	±2%	GJM1552C1H360GB01#	±0.5pF	GJM1553C1H3R0DB01#						
	±5%	GJM1552C1H360JB01#	±2%	GJM1553C1H3R0GB01#						
	39pF	±1%	GJM1552C1H390FB01#	3.1pF	±0.05pF	GJM1553C1H3R1WB01#				
±2%		GJM1552C1H390GB01#	±0.1pF		GJM1553C1H3R1BB01#					
±5%		GJM1552C1H390JB01#	±0.25pF		GJM1553C1H3R1CB01#					
43pF	±1%	GJM1552C1H430FB01#	±0.5pF		GJM1553C1H3R1DB01#					
	±2%	GJM1552C1H430GB01#	±2%		GJM1553C1H3R1GB01#					
	±5%	GJM1552C1H430JB01#	±0.05pF		GJM1553C1H3R1WB01#					
47pF	±1%	GJM1552C1H470FB01#	±0.1pF		GJM1553C1H3R1BB01#					

Part number # indicates the package specification code.

- GRM
- GR3
- GRJ
- GR4
- GJM
- GQM
- GQZ
- GA2
- GA3 GB
- GA3 GD
- GA3 GF
- LLL
- LLA
- LLM
- LLR
- NFM
- GJ4
- ZRA
- ZRB
- KRM
- KR3
- GMA
- GMD
- ⚠Caution /Notice

GJM Series Temperature Compensating Type High Q Part Number List

(→ 1.0×0.5mm)

Rated Voltage	TC Code	Cap.	Tol.	Part Number	Rated Voltage	TC Code	Cap.	Tol.	Part Number	
50Vdc	CJ	3.1pF	±0.25pF	GJM1553C1H3R1CB01#	50Vdc	CK	0.15pF	±0.1pF	GJM1554C1HR15BB01#	
			±0.5pF	GJM1553C1H3R1DB01#				0.16pF	±0.05pF	GJM1554C1HR16WB01#
			±2%	GJM1553C1H3R1GB01#			0.18pF		±0.1pF	GJM1554C1HR16BB01#
		3.2pF	±0.05pF	GJM1553C1H3R2WB01#				0.20pF	±0.05pF	GJM1554C1HR18WB01#
			±0.1pF	GJM1553C1H3R2BB01#			0.22pF		±0.1pF	GJM1554C1HR18BB01#
			±0.25pF	GJM1553C1H3R2CB01#				0.24pF	±0.05pF	GJM1554C1HR20WB01#
			±0.5pF	GJM1553C1H3R2DB01#			0.25pF		±0.1pF	GJM1554C1HR20BB01#
			±2%	GJM1553C1H3R2GB01#				0.27pF	±0.05pF	GJM1554C1HR22WB01#
			3.3pF	±0.05pF			GJM1553C1H3R3WB01#		0.30pF	±0.1pF
		±0.1pF		GJM1553C1H3R3BB01#			0.33pF	±0.05pF		GJM1554C1HR24WB01#
		±0.25pF		GJM1553C1H3R3CB01#				0.36pF	±0.1pF	GJM1554C1HR24BB01#
		±0.5pF		GJM1553C1H3R3DB01#			0.39pF		±0.03pF	GJM1554C1HR25RB12#
		±2%		GJM1553C1H3R3GB01#				0.40pF	±0.1pF	GJM1554C1HR25BB01#
		3.4pF		±0.05pF			GJM1553C1H3R4WB01#		0.43pF	±0.05pF
			±0.1pF	GJM1553C1H3R4BB01#			0.45pF	±0.1pF		GJM1554C1HR27BB01#
			±0.25pF	GJM1553C1H3R4CB01#				0.47pF	±0.25pF	GJM1554C1HR27CB01#
			±0.5pF	GJM1553C1H3R4DB01#			0.50pF		±0.05pF	GJM1554C1HR30WB01#
			±2%	GJM1553C1H3R4GB01#				0.51pF	±0.1pF	GJM1554C1HR30BB01#
			3.5pF	±0.05pF			GJM1553C1H3R5WB01#		0.56pF	±0.25pF
		±0.1pF		GJM1553C1H3R5BB01#			0.60pF	±0.05pF		GJM1554C1HR33WB01#
		±0.25pF		GJM1553C1H3R5CB01#				0.60pF	±0.1pF	GJM1554C1HR33BB01#
		±0.5pF		GJM1553C1H3R5DB01#			0.60pF		±0.25pF	GJM1554C1HR33CB01#
		±2%		GJM1553C1H3R5GB01#				0.36pF	±0.05pF	GJM1554C1HR36WB01#
		3.6pF		±0.05pF			GJM1553C1H3R6WB01#		0.39pF	±0.1pF
			±0.1pF	GJM1553C1H3R6BB01#			0.40pF	±0.25pF		GJM1554C1HR36CB01#
			±0.25pF	GJM1553C1H3R6CB01#				0.43pF	±0.05pF	GJM1554C1HR39WB01#
			±0.5pF	GJM1553C1H3R6DB01#			0.45pF		±0.1pF	GJM1554C1HR39BB01#
			±2%	GJM1553C1H3R6GB01#				0.47pF	±0.25pF	GJM1554C1HR39CB01#
			3.7pF	±0.05pF			GJM1553C1H3R7WB01#		0.40pF	±0.05pF
		±0.1pF		GJM1553C1H3R7BB01#			0.43pF	±0.1pF		GJM1554C1HR40BB01#
		±0.25pF		GJM1553C1H3R7CB01#				0.45pF	±0.25pF	GJM1554C1HR40CB01#
		±0.5pF		GJM1553C1H3R7DB01#			0.43pF		±0.05pF	GJM1554C1HR43WB01#
		±2%		GJM1553C1H3R7GB01#				0.45pF	±0.1pF	GJM1554C1HR43BB01#
		3.8pF		±0.05pF			GJM1553C1H3R8WB01#		0.47pF	±0.25pF
			±0.1pF	GJM1553C1H3R8BB01#			0.45pF	±0.03pF		GJM1554C1HR45RB12#
			±0.25pF	GJM1553C1H3R8CB01#				0.47pF	±0.05pF	GJM1554C1HR45WB01#
			±0.5pF	GJM1553C1H3R8DB01#			0.50pF		±0.05pF	GJM1554C1HR47WB01#
			±2%	GJM1553C1H3R8GB01#				0.51pF	±0.1pF	GJM1554C1HR47BB01#
			3.9pF	±0.05pF			GJM1553C1H3R9WB01#		0.50pF	±0.25pF
		±0.1pF		GJM1553C1H3R9BB01#			0.50pF	±0.03pF		GJM1554C1HR50RB12#
		±0.25pF		GJM1553C1H3R9CB01#				0.51pF	±0.05pF	GJM1554C1HR50WB01#
		±0.5pF		GJM1553C1H3R9DB01#			0.51pF		±0.1pF	GJM1554C1HR50BB01#
		±2%		GJM1553C1H3R9GB01#				0.51pF	±0.25pF	GJM1554C1HR50DB01#
		CK		0.10pF			±0.05pF		GJM1554C1HR10WB01#	0.51pF
			±0.1pF				GJM1554C1HR10BB01#	0.56pF	±0.1pF	
			±20%				GJM1554C1HR10MB01#		0.56pF	±0.25pF
			0.11pF	±0.05pF			GJM1554C1HR11WB01#	0.56pF		±0.5pF
				±0.1pF			GJM1554C1HR11BB01#		0.56pF	±0.05pF
			0.12pF	±0.05pF			GJM1554C1HR12WB01#	0.56pF		±0.1pF
		±0.1pF		GJM1554C1HR12BB01#			0.56pF		±0.25pF	GJM1554C1HR56CB01#
	0.13pF	±0.05pF	GJM1554C1HR13WB01#	0.56pF	±0.5pF	GJM1554C1HR56DB01#				
		±0.1pF	GJM1554C1HR13BB01#		0.60pF	±0.05pF	GJM1554C1HR60WB01#			
	0.15pF	±0.03pF	GJM1554C1HR15RB12#	0.60pF		±0.1pF	GJM1554C1HR60BB01#			
		±0.05pF	GJM1554C1HR15WB01#							

- GRM
- GR3
- GRJ
- GR4
- GJM
- GQM
- GQ2
- GA2
- GA3
- GA3
- GA3
- GA3
- LL
- LLA
- LLM
- LLR
- NFM
- GJ4
- ZRA
- ZRB
- KRM
- KR3
- GMA
- GMD
- △Caution / Notice

Part number # indicates the package specification code.

GJM Series Temperature Compensating Type High Q Part Number List

(→ 1.0×0.5mm)

Rated Voltage	TC Code	Cap.	Tol.	Part Number
50Vdc	CK	0.60pF	±0.25pF	GJM1554C1HR60CB01#
			±0.5pF	GJM1554C1HR60DB01#
		0.62pF	±0.05pF	GJM1554C1HR62WB01#
			±0.1pF	GJM1554C1HR62BB01#
			±0.25pF	GJM1554C1HR62CB01#
			±0.5pF	GJM1554C1HR62DB01#
		0.68pF	±0.05pF	GJM1554C1HR68WB01#
			±0.1pF	GJM1554C1HR68BB01#
			±0.25pF	GJM1554C1HR68CB01#
			±0.5pF	GJM1554C1HR68DB01#
		0.70pF	±0.05pF	GJM1554C1HR70WB01#
			±0.1pF	GJM1554C1HR70BB01#
			±0.25pF	GJM1554C1HR70CB01#
			±0.5pF	GJM1554C1HR70DB01#
		0.75pF	±0.05pF	GJM1554C1HR75WB01#
			±0.1pF	GJM1554C1HR75BB01#
			±0.25pF	GJM1554C1HR75CB01#
			±0.5pF	GJM1554C1HR75DB01#
		0.80pF	±0.05pF	GJM1554C1HR80WB01#
			±0.1pF	GJM1554C1HR80BB01#
			±0.25pF	GJM1554C1HR80CB01#
			±0.5pF	GJM1554C1HR80DB01#
		0.82pF	±0.05pF	GJM1554C1HR82WB01#
			±0.1pF	GJM1554C1HR82BB01#
			±0.25pF	GJM1554C1HR82CB01#
			±0.5pF	GJM1554C1HR82DB01#
		0.85pF	±0.05pF	GJM1554C1HR85WB01#
		0.90pF	±0.05pF	GJM1554C1HR90WB01#
			±0.1pF	GJM1554C1HR90BB01#
			±0.25pF	GJM1554C1HR90CB01#
			±0.5pF	GJM1554C1HR90DB01#
		0.91pF	±0.05pF	GJM1554C1HR91WB01#
			±0.1pF	GJM1554C1HR91BB01#
			±0.25pF	GJM1554C1HR91CB01#
			±0.5pF	GJM1554C1HR91DB01#
		0.95pF	±0.05pF	GJM1554C1HR95WB01#
		1.0pF	±0.05pF	GJM1554C1H1R0WB01#
			±0.1pF	GJM1554C1H1R0BB01#
			±0.25pF	GJM1554C1H1R0CB01#
			±0.5pF	GJM1554C1H1R0DB01#
			±5%	GJM1554C1H1R0JB01#
		1.1pF	±0.05pF	GJM1554C1H1R1WB01#
			±0.1pF	GJM1554C1H1R1BB01#
			±0.25pF	GJM1554C1H1R1CB01#
			±0.5pF	GJM1554C1H1R1DB01#
			±5%	GJM1554C1H1R1JB01#
		1.2pF	±0.05pF	GJM1554C1H1R2WB01#
			±0.1pF	GJM1554C1H1R2BB01#
			±0.25pF	GJM1554C1H1R2CB01#
			±0.5pF	GJM1554C1H1R2DB01#
			±5%	GJM1554C1H1R2JB01#
		1.3pF	±0.05pF	GJM1554C1H1R3WB01#
			±0.1pF	GJM1554C1H1R3BB01#
			±0.25pF	GJM1554C1H1R3CB01#

Rated Voltage	TC Code	Cap.	Tol.	Part Number
50Vdc	CK	1.3pF	±0.5pF	GJM1554C1H1R3DB01#
			±5%	GJM1554C1H1R3JB01#
		1.4pF	±0.05pF	GJM1554C1H1R4WB01#
			±0.1pF	GJM1554C1H1R4BB01#
			±0.25pF	GJM1554C1H1R4CB01#
			±0.5pF	GJM1554C1H1R4DB01#
			±5%	GJM1554C1H1R4JB01#
		1.5pF	±0.05pF	GJM1554C1H1R5WB01#
			±0.1pF	GJM1554C1H1R5BB01#
			±0.25pF	GJM1554C1H1R5CB01#
			±0.5pF	GJM1554C1H1R5DB01#
			±5%	GJM1554C1H1R5JB01#
		1.6pF	±0.05pF	GJM1554C1H1R6WB01#
			±0.1pF	GJM1554C1H1R6BB01#
			±0.25pF	GJM1554C1H1R6CB01#
			±0.5pF	GJM1554C1H1R6DB01#
			±5%	GJM1554C1H1R6JB01#
		1.7pF	±0.05pF	GJM1554C1H1R7WB01#
			±0.1pF	GJM1554C1H1R7BB01#
			±0.25pF	GJM1554C1H1R7CB01#
			±0.5pF	GJM1554C1H1R7DB01#
			±5%	GJM1554C1H1R7JB01#
		1.8pF	±0.05pF	GJM1554C1H1R8WB01#
			±0.1pF	GJM1554C1H1R8BB01#
			±0.25pF	GJM1554C1H1R8CB01#
			±0.5pF	GJM1554C1H1R8DB01#
			±5%	GJM1554C1H1R8JB01#
		1.9pF	±0.05pF	GJM1554C1H1R9WB01#
			±0.1pF	GJM1554C1H1R9BB01#
			±0.25pF	GJM1554C1H1R9CB01#
			±0.5pF	GJM1554C1H1R9DB01#
			±5%	GJM1554C1H1R9JB01#
		2.0pF	±0.05pF	GJM1554C1H2R0WB01#
			±0.1pF	GJM1554C1H2R0BB01#
			±0.25pF	GJM1554C1H2R0CB01#
			±0.5pF	GJM1554C1H2R0DB01#
			±2%	GJM1554C1H2R0GB01#

- GRM
- GR3
- GRJ
- GR4
- GJM
- GQM
- GA2
- GA3 GB
- GA3 GD
- GA3 GF
- LLL
- LLA
- LLM
- LLR
- NFM
- GJ4
- ZRA
- ZRB
- KRM
- KR3
- GMA
- GMD
- ⚠Caution /Notice

Part number # indicates the package specification code.

High Q and High Power Chip Multilayer Ceramic Capacitors for General Purpose (>100Vdc)

GQM Series  **High Q** 

High Frequency Capacitor Ideal for PA Design of Base Stations

Features

① **Mainly ideal for base stations of mobile communication devices and temperature compensation of related modules.**

This product is ideal for temperature compensation of high frequency circuits, such as resonant circuits, tuning circuits, and impedance matching circuits where the operating characteristics of the device are greatly affected by the capacitance fluctuation.

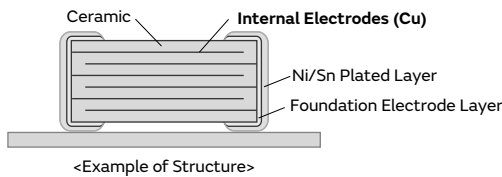

② **High Q and low ESR in VHF, UHF and microwave frequency bands.**

High Q and low ESR were achieved at a high frequency by adopting ceramic material as the dielectric material which enables an extremely low loss at high frequency, and base metal electrodes as the internal electrodes.

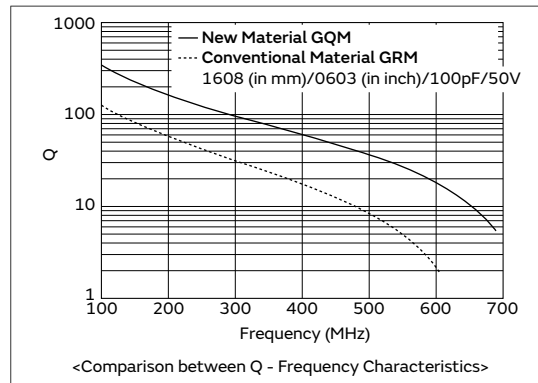
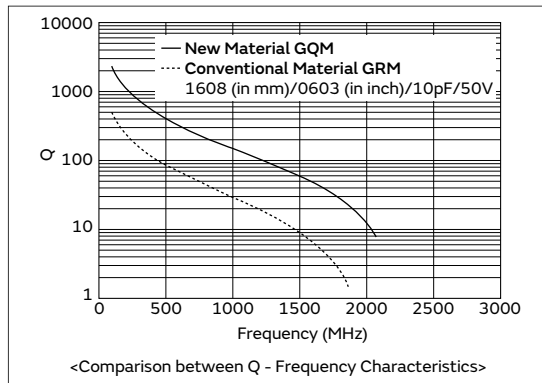

③ **Can be used for tight tolerance.**

In addition to standard tolerance, the allowable range of this product is also suitable for the following narrow tolerance.

Capacitance Range	Standard Capacitance Tolerance (Capacitance Tolerance Symbol)	Narrow Capacitance Tolerance (Capacitance Tolerance Symbol)
to 0.9pF	±0.1pF (B)	±0.05pF (W)
1.0 to 5.0pF	±0.25pF (C)	±0.05pF (W), ±0.1pF (B)
5.1 to 9.9pF	±0.5pF (D)	±0.05pF (W), ±0.1pF (B), ±0.25pF (C)
10pF-	±5% (J)	±2% (G)

Specifications

Size (mm)	1.0×0.5mm to 2.8×2.8mm
Rated Voltage	200Vdc to 500Vdc
Capacitance	0.10pF to 150pF
Main Applications	Measuring instruments, other ultra compact/thin devices

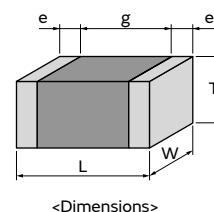

This catalog contains only a portion of the product lineup.
 Please refer to the capacitor search tool on the Murata Web site for details.

GQM Series Temperature Compensating Type High Q Part Number List

1.0×0.5mm

Rated Voltage	TC Code	Cap.	Tol.	Part Number
200Vdc	COG	0.10pF	±0.05pF	GQM1555C2DR10WB01#
			±0.1pF	GQM1555C2DR10BB01#
		0.20pF	±0.05pF	GQM1555C2DR20WB01#
			±0.1pF	GQM1555C2DR20BB01#
		0.30pF	±0.05pF	GQM1555C2DR30WB01#
			±0.1pF	GQM1555C2DR30BB01#
			±0.25pF	GQM1555C2DR30CB01#
		0.40pF	±0.05pF	GQM1555C2DR40WB01#
			±0.1pF	GQM1555C2DR40BB01#
			±0.25pF	GQM1555C2DR40CB01#
		0.50pF	±0.05pF	GQM1555C2DR50WB01#
			±0.1pF	GQM1555C2DR50BB01#
			±0.25pF	GQM1555C2DR50CB01#
		0.60pF	±0.05pF	GQM1555C2DR60WB01#
			±0.1pF	GQM1555C2DR60BB01#
			±0.25pF	GQM1555C2DR60CB01#
		0.70pF	±0.05pF	GQM1555C2DR70WB01#
			±0.1pF	GQM1555C2DR70BB01#
			±0.25pF	GQM1555C2DR70CB01#
		0.75pF	±0.05pF	GQM1555C2DR75WB01#
			±0.1pF	GQM1555C2DR75BB01#
			±0.25pF	GQM1555C2DR75CB01#
		0.80pF	±0.05pF	GQM1555C2DR80WB01#
			±0.1pF	GQM1555C2DR80BB01#
			±0.25pF	GQM1555C2DR80CB01#
		0.90pF	±0.05pF	GQM1555C2DR90WB01#
			±0.1pF	GQM1555C2DR90BB01#
			±0.25pF	GQM1555C2DR90CB01#
		1.0pF	±0.05pF	GQM1555C2D1R0WB01#
			±0.1pF	GQM1555C2D1R0BB01#
			±0.25pF	GQM1555C2D1R0CB01#
		1.1pF	±0.05pF	GQM1555C2D1R1WB01#
			±0.1pF	GQM1555C2D1R1BB01#
			±0.25pF	GQM1555C2D1R1CB01#
		1.2pF	±0.05pF	GQM1555C2D1R2WB01#
			±0.1pF	GQM1555C2D1R2BB01#
			±0.25pF	GQM1555C2D1R2CB01#
		1.3pF	±0.05pF	GQM1555C2D1R3WB01#
			±0.1pF	GQM1555C2D1R3BB01#
			±0.25pF	GQM1555C2D1R3CB01#
		1.4pF	±0.05pF	GQM1555C2D1R4WB01#
			±0.1pF	GQM1555C2D1R4BB01#
			±0.25pF	GQM1555C2D1R4CB01#
		1.5pF	±0.05pF	GQM1555C2D1R5WB01#
			±0.1pF	GQM1555C2D1R5BB01#
			±0.25pF	GQM1555C2D1R5CB01#
		1.6pF	±0.05pF	GQM1555C2D1R6WB01#
			±0.1pF	GQM1555C2D1R6BB01#
			±0.25pF	GQM1555C2D1R6CB01#
		1.7pF	±0.05pF	GQM1555C2D1R7WB01#
			±0.1pF	GQM1555C2D1R7BB01#
			±0.25pF	GQM1555C2D1R7CB01#

Rated Voltage	TC Code	Cap.	Tol.	Part Number
200Vdc	COG	1.8pF	±0.05pF	GQM1555C2D1R8WB01#
			±0.1pF	GQM1555C2D1R8BB01#
			±0.25pF	GQM1555C2D1R8CB01#
		1.9pF	±0.05pF	GQM1555C2D1R9WB01#
			±0.1pF	GQM1555C2D1R9BB01#
			±0.25pF	GQM1555C2D1R9CB01#
		2.0pF	±0.05pF	GQM1555C2D2R0WB01#
			±0.1pF	GQM1555C2D2R0BB01#
			±0.25pF	GQM1555C2D2R0CB01#
		2.1pF	±0.05pF	GQM1555C2D2R1WB01#
			±0.1pF	GQM1555C2D2R1BB01#
			±0.25pF	GQM1555C2D2R1CB01#
		2.2pF	±0.05pF	GQM1555C2D2R2WB01#
			±0.1pF	GQM1555C2D2R2BB01#
			±0.25pF	GQM1555C2D2R2CB01#
		2.3pF	±0.05pF	GQM1555C2D2R3WB01#
			±0.1pF	GQM1555C2D2R3BB01#
			±0.25pF	GQM1555C2D2R3CB01#
		2.4pF	±0.05pF	GQM1555C2D2R4WB01#
			±0.1pF	GQM1555C2D2R4BB01#
			±0.25pF	GQM1555C2D2R4CB01#
		2.5pF	±0.05pF	GQM1555C2D2R5WB01#
			±0.1pF	GQM1555C2D2R5BB01#
			±0.25pF	GQM1555C2D2R5CB01#
		2.6pF	±0.05pF	GQM1555C2D2R6WB01#
			±0.1pF	GQM1555C2D2R6BB01#
			±0.25pF	GQM1555C2D2R6CB01#
		2.7pF	±0.05pF	GQM1555C2D2R7WB01#
			±0.1pF	GQM1555C2D2R7BB01#
			±0.25pF	GQM1555C2D2R7CB01#
		2.8pF	±0.05pF	GQM1555C2D2R8WB01#
			±0.1pF	GQM1555C2D2R8BB01#
			±0.25pF	GQM1555C2D2R8CB01#
		2.9pF	±0.05pF	GQM1555C2D2R9WB01#
			±0.1pF	GQM1555C2D2R9BB01#
			±0.25pF	GQM1555C2D2R9CB01#
		3.0pF	±0.05pF	GQM1555C2D3R0WB01#
			±0.1pF	GQM1555C2D3R0BB01#
			±0.25pF	GQM1555C2D3R0CB01#
		3.1pF	±0.05pF	GQM1555C2D3R1WB01#
			±0.1pF	GQM1555C2D3R1BB01#
			±0.25pF	GQM1555C2D3R1CB01#
		3.2pF	±0.05pF	GQM1555C2D3R2WB01#
			±0.1pF	GQM1555C2D3R2BB01#
			±0.25pF	GQM1555C2D3R2CB01#
		3.3pF	±0.05pF	GQM1555C2D3R3WB01#
			±0.1pF	GQM1555C2D3R3BB01#
			±0.25pF	GQM1555C2D3R3CB01#
		3.4pF	±0.05pF	GQM1555C2D3R4WB01#
			±0.1pF	GQM1555C2D3R4BB01#
			±0.25pF	GQM1555C2D3R4CB01#
		3.5pF	±0.05pF	GQM1555C2D3R5WB01#
			±0.1pF	GQM1555C2D3R5BB01#
			±0.25pF	GQM1555C2D3R5CB01#

Part number # indicates the package specification code.

- GRM
- GR3
- GRJ
- GR4
- GJM
- GQM**
- GA2
- GA3 GB
- GA3 GD
- GA3 GF
- LLL
- LLA
- LLM
- LLR
- NFM
- GJ4
- ZRA
- ZRB
- KRM
- KR3
- GMA
- GMD
- ⚠Caution /Notice

GQM Series Temperature Compensating Type High Q Part Number List

(→ 1.0×0.5mm)

Rated Voltage	TC Code	Cap.	Tol.	Part Number	Rated Voltage	TC Code	Cap.	Tol.	Part Number
200Vdc	COG	3.6pF	±0.05pF	GQM1555C2D3R6WB01#	200Vdc	COG	5.4pF	±0.05pF	GQM1555C2D5R4WB01#
			±0.1pF	GQM1555C2D3R6BB01#				±0.1pF	GQM1555C2D5R4BB01#
			±0.25pF	GQM1555C2D3R6CB01#				±0.25pF	GQM1555C2D5R4CB01#
		3.7pF	±0.05pF	GQM1555C2D3R7WB01#			5.5pF	±0.05pF	GQM1555C2D5R5WB01#
			±0.1pF	GQM1555C2D3R7BB01#				±0.1pF	GQM1555C2D5R5BB01#
			±0.25pF	GQM1555C2D3R7CB01#				±0.25pF	GQM1555C2D5R5CB01#
		3.8pF	±0.05pF	GQM1555C2D3R8WB01#			5.6pF	±0.05pF	GQM1555C2D5R6WB01#
			±0.1pF	GQM1555C2D3R8BB01#				±0.1pF	GQM1555C2D5R6BB01#
			±0.25pF	GQM1555C2D3R8CB01#				±0.25pF	GQM1555C2D5R6CB01#
		3.9pF	±0.05pF	GQM1555C2D3R9WB01#			5.7pF	±0.05pF	GQM1555C2D5R7WB01#
			±0.1pF	GQM1555C2D3R9BB01#				±0.1pF	GQM1555C2D5R7BB01#
			±0.25pF	GQM1555C2D3R9CB01#				±0.25pF	GQM1555C2D5R7CB01#
		4.0pF	±0.05pF	GQM1555C2D4R0WB01#			5.8pF	±0.05pF	GQM1555C2D5R8WB01#
			±0.1pF	GQM1555C2D4R0BB01#				±0.1pF	GQM1555C2D5R8BB01#
			±0.25pF	GQM1555C2D4R0CB01#				±0.25pF	GQM1555C2D5R8CB01#
		4.1pF	±0.05pF	GQM1555C2D4R1WB01#			5.9pF	±0.05pF	GQM1555C2D5R9WB01#
			±0.1pF	GQM1555C2D4R1BB01#				±0.1pF	GQM1555C2D5R9BB01#
			±0.25pF	GQM1555C2D4R1CB01#				±0.25pF	GQM1555C2D5R9CB01#
		4.2pF	±0.05pF	GQM1555C2D4R2WB01#			6.0pF	±0.05pF	GQM1555C2D6R0WB01#
			±0.1pF	GQM1555C2D4R2BB01#				±0.1pF	GQM1555C2D6R0BB01#
			±0.25pF	GQM1555C2D4R2CB01#				±0.25pF	GQM1555C2D6R0CB01#
		4.3pF	±0.05pF	GQM1555C2D4R3WB01#			6.1pF	±0.05pF	GQM1555C2D6R1WB01#
			±0.1pF	GQM1555C2D4R3BB01#				±0.1pF	GQM1555C2D6R1BB01#
			±0.25pF	GQM1555C2D4R3CB01#				±0.25pF	GQM1555C2D6R1CB01#
		4.4pF	±0.05pF	GQM1555C2D4R4WB01#			6.2pF	±0.05pF	GQM1555C2D6R2WB01#
			±0.1pF	GQM1555C2D4R4BB01#				±0.1pF	GQM1555C2D6R2BB01#
			±0.25pF	GQM1555C2D4R4CB01#				±0.25pF	GQM1555C2D6R2CB01#
		4.5pF	±0.05pF	GQM1555C2D4R5WB01#			6.3pF	±0.05pF	GQM1555C2D6R3WB01#
			±0.1pF	GQM1555C2D4R5BB01#				±0.1pF	GQM1555C2D6R3BB01#
			±0.25pF	GQM1555C2D4R5CB01#				±0.25pF	GQM1555C2D6R3CB01#
		4.6pF	±0.05pF	GQM1555C2D4R6WB01#			6.4pF	±0.05pF	GQM1555C2D6R4WB01#
			±0.1pF	GQM1555C2D4R6BB01#				±0.1pF	GQM1555C2D6R4BB01#
			±0.25pF	GQM1555C2D4R6CB01#				±0.25pF	GQM1555C2D6R4CB01#
		4.7pF	±0.05pF	GQM1555C2D4R7WB01#			6.5pF	±0.05pF	GQM1555C2D6R5WB01#
			±0.1pF	GQM1555C2D4R7BB01#				±0.1pF	GQM1555C2D6R5BB01#
			±0.25pF	GQM1555C2D4R7CB01#				±0.25pF	GQM1555C2D6R5CB01#
		4.8pF	±0.05pF	GQM1555C2D4R8WB01#			6.6pF	±0.05pF	GQM1555C2D6R6WB01#
			±0.1pF	GQM1555C2D4R8BB01#				±0.1pF	GQM1555C2D6R6BB01#
			±0.25pF	GQM1555C2D4R8CB01#				±0.25pF	GQM1555C2D6R6CB01#
		4.9pF	±0.05pF	GQM1555C2D4R9WB01#			6.7pF	±0.05pF	GQM1555C2D6R7WB01#
			±0.1pF	GQM1555C2D4R9BB01#				±0.1pF	GQM1555C2D6R7BB01#
			±0.25pF	GQM1555C2D4R9CB01#				±0.25pF	GQM1555C2D6R7CB01#
		5.0pF	±0.05pF	GQM1555C2D5R0WB01#			6.8pF	±0.05pF	GQM1555C2D6R8WB01#
			±0.1pF	GQM1555C2D5R0BB01#				±0.1pF	GQM1555C2D6R8BB01#
			±0.25pF	GQM1555C2D5R0CB01#				±0.25pF	GQM1555C2D6R8CB01#
		5.1pF	±0.05pF	GQM1555C2D5R1WB01#			6.9pF	±0.05pF	GQM1555C2D6R9WB01#
			±0.1pF	GQM1555C2D5R1BB01#				±0.1pF	GQM1555C2D6R9BB01#
			±0.25pF	GQM1555C2D5R1CB01#				±0.25pF	GQM1555C2D6R9CB01#
		5.2pF	±0.05pF	GQM1555C2D5R2WB01#			7.0pF	±0.05pF	GQM1555C2D7R0WB01#
			±0.1pF	GQM1555C2D5R2BB01#				±0.1pF	GQM1555C2D7R0BB01#
			±0.25pF	GQM1555C2D5R2CB01#				±0.25pF	GQM1555C2D7R0CB01#
		5.3pF	±0.05pF	GQM1555C2D5R3WB01#			7.1pF	±0.05pF	GQM1555C2D7R1WB01#
			±0.1pF	GQM1555C2D5R3BB01#				±0.1pF	GQM1555C2D7R1BB01#
			±0.25pF	GQM1555C2D5R3CB01#				±0.25pF	GQM1555C2D7R1CB01#

- GRM
- GR3
- GRJ
- GR4
- GJM
- GQM**
- GA2
- GA3 GB
- GA3 GD
- GA3 GF
- LLL
- LLA
- LLM
- LLR
- NFM
- GJ4
- ZRA
- ZRB
- KRM
- KR3
- GMA
- GMD
- ⚠Caution /Notice

Part number # indicates the package specification code.

GQM Series Temperature Compensating Type High Q Part Number List

(→ 1.0×0.5mm)

Rated Voltage	TC Code	Cap.	Tol.	Part Number	Rated Voltage	TC Code	Cap.	Tol.	Part Number
200Vdc	COG	7.2pF	±0.05pF	GQM1555C2D7R2WB01#	200Vdc	COG	9.0pF	±0.05pF	GQM1555C2D9R0WB01#
			±0.1pF	GQM1555C2D7R2BB01#				±0.1pF	GQM1555C2D9R0BB01#
			±0.25pF	GQM1555C2D7R2CB01#				±0.25pF	GQM1555C2D9R0CB01#
		7.3pF	±0.05pF	GQM1555C2D7R3WB01#			9.1pF	±0.05pF	GQM1555C2D9R1WB01#
			±0.1pF	GQM1555C2D7R3BB01#				±0.1pF	GQM1555C2D9R1BB01#
			±0.25pF	GQM1555C2D7R3CB01#				±0.25pF	GQM1555C2D9R1CB01#
		7.4pF	±0.05pF	GQM1555C2D7R4WB01#			9.2pF	±0.05pF	GQM1555C2D9R2WB01#
			±0.1pF	GQM1555C2D7R4BB01#				±0.1pF	GQM1555C2D9R2BB01#
			±0.25pF	GQM1555C2D7R4CB01#				±0.25pF	GQM1555C2D9R2CB01#
		7.5pF	±0.05pF	GQM1555C2D7R5WB01#			9.3pF	±0.05pF	GQM1555C2D9R3WB01#
			±0.1pF	GQM1555C2D7R5BB01#				±0.1pF	GQM1555C2D9R3BB01#
			±0.25pF	GQM1555C2D7R5CB01#				±0.25pF	GQM1555C2D9R3CB01#
		7.6pF	±0.05pF	GQM1555C2D7R6WB01#			9.4pF	±0.05pF	GQM1555C2D9R4WB01#
			±0.1pF	GQM1555C2D7R6BB01#				±0.1pF	GQM1555C2D9R4BB01#
			±0.25pF	GQM1555C2D7R6CB01#				±0.25pF	GQM1555C2D9R4CB01#
		7.7pF	±0.05pF	GQM1555C2D7R7WB01#			9.5pF	±0.05pF	GQM1555C2D9R5WB01#
			±0.1pF	GQM1555C2D7R7BB01#				±0.1pF	GQM1555C2D9R5BB01#
			±0.25pF	GQM1555C2D7R7CB01#				±0.25pF	GQM1555C2D9R5CB01#
		7.8pF	±0.05pF	GQM1555C2D7R8WB01#			9.6pF	±0.05pF	GQM1555C2D9R6WB01#
			±0.1pF	GQM1555C2D7R8BB01#				±0.1pF	GQM1555C2D9R6BB01#
			±0.25pF	GQM1555C2D7R8CB01#				±0.25pF	GQM1555C2D9R6CB01#
		7.9pF	±0.05pF	GQM1555C2D7R9WB01#			9.7pF	±0.05pF	GQM1555C2D9R7WB01#
			±0.1pF	GQM1555C2D7R9BB01#				±0.1pF	GQM1555C2D9R7BB01#
			±0.25pF	GQM1555C2D7R9CB01#				±0.25pF	GQM1555C2D9R7CB01#
		8.0pF	±0.05pF	GQM1555C2D8R0WB01#			9.8pF	±0.05pF	GQM1555C2D9R8WB01#
			±0.1pF	GQM1555C2D8R0BB01#				±0.1pF	GQM1555C2D9R8BB01#
			±0.25pF	GQM1555C2D8R0CB01#				±0.25pF	GQM1555C2D9R8CB01#
		8.1pF	±0.05pF	GQM1555C2D8R1WB01#			9.9pF	±0.05pF	GQM1555C2D9R9WB01#
			±0.1pF	GQM1555C2D8R1BB01#				±0.1pF	GQM1555C2D9R9BB01#
			±0.25pF	GQM1555C2D8R1CB01#				±0.25pF	GQM1555C2D9R9CB01#
		8.2pF	±0.05pF	GQM1555C2D8R2WB01#			10pF	±1%	GQM1555C2D100FB01#
			±0.1pF	GQM1555C2D8R2BB01#				±2%	GQM1555C2D100GB01#
			±0.25pF	GQM1555C2D8R2CB01#				±5%	GQM1555C2D100JB01#
		8.3pF	±0.05pF	GQM1555C2D8R3WB01#			11pF	±1%	GQM1555C2D110FB01#
			±0.1pF	GQM1555C2D8R3BB01#				±2%	GQM1555C2D110GB01#
			±0.25pF	GQM1555C2D8R3CB01#				±5%	GQM1555C2D110JB01#
		8.4pF	±0.05pF	GQM1555C2D8R4WB01#			12pF	±1%	GQM1555C2D120FB01#
			±0.1pF	GQM1555C2D8R4BB01#				±2%	GQM1555C2D120GB01#
			±0.25pF	GQM1555C2D8R4CB01#				±5%	GQM1555C2D120JB01#
		8.5pF	±0.05pF	GQM1555C2D8R5WB01#			13pF	±1%	GQM1555C2D130FB01#
			±0.1pF	GQM1555C2D8R5BB01#				±2%	GQM1555C2D130GB01#
			±0.25pF	GQM1555C2D8R5CB01#				±5%	GQM1555C2D130JB01#
		8.6pF	±0.05pF	GQM1555C2D8R6WB01#			15pF	±1%	GQM1555C2D150FB01#
			±0.1pF	GQM1555C2D8R6BB01#				±2%	GQM1555C2D150GB01#
			±0.25pF	GQM1555C2D8R6CB01#				±5%	GQM1555C2D150JB01#
		8.7pF	±0.05pF	GQM1555C2D8R7WB01#			16pF	±1%	GQM1555C2D160FB01#
			±0.1pF	GQM1555C2D8R7BB01#				±2%	GQM1555C2D160GB01#
			±0.25pF	GQM1555C2D8R7CB01#				±5%	GQM1555C2D160JB01#
		8.8pF	±0.05pF	GQM1555C2D8R8WB01#			18pF	±1%	GQM1555C2D180FB01#
			±0.1pF	GQM1555C2D8R8BB01#				±2%	GQM1555C2D180GB01#
			±0.25pF	GQM1555C2D8R8CB01#				±5%	GQM1555C2D180JB01#
		8.9pF	±0.05pF	GQM1555C2D8R9WB01#			20pF	±1%	GQM1555C2D200FB01#
			±0.1pF	GQM1555C2D8R9BB01#				±2%	GQM1555C2D200GB01#
			±0.25pF	GQM1555C2D8R9CB01#				±5%	GQM1555C2D200JB01#

Part number # indicates the package specification code.

GRM
 GR3
 GRJ
 GR4
 GJM
GQM
 GA2
 GA3 GB
 GA3 GD
 GA3 GF
 LLL
 LLA
 LLM
 LLR
 NFM
 GJ4
 ZRA
 ZRB
 KRM
 KR3
 GMA
 GMD
 ⚠Caution /Notice

GQM Series Temperature Compensating Type High Q Part Number List

(→ 1.0×0.5mm)

Rated Voltage	TC Code	Cap.	Tol.	Part Number	Rated Voltage	TC Code	Cap.	Tol.	Part Number	
200Vdc	COG	22pF	±1%	GQM1555C2D220FB01#	200Vdc	X8G	1.3pF	±0.25pF	GQM1555G2D1R3CB01#	
			±2%	GQM1555C2D220GB01#				1.4pF	±0.05pF	GQM1555G2D1R4WB01#
			±5%	GQM1555C2D220JB01#					±0.1pF	GQM1555G2D1R4BB01#
				±0.25pF			GQM1555G2D1R4CB01#			
		24pF	±1%	GQM1555C2D240FB01#			1.5pF	±0.05pF	GQM1555G2D1R5WB01#	
			±2%	GQM1555C2D240GB01#				±0.1pF	GQM1555G2D1R5BB01#	
			±5%	GQM1555C2D240JB01#				±0.25pF	GQM1555G2D1R5CB01#	
		27pF	±1%	GQM1555C2D270FB01#			1.6pF	±0.05pF	GQM1555G2D1R6WB01#	
			±2%	GQM1555C2D270GB01#				±0.1pF	GQM1555G2D1R6BB01#	
			±5%	GQM1555C2D270JB01#				±0.25pF	GQM1555G2D1R6CB01#	
		30pF	±1%	GQM1555C2D300FB01#			1.7pF	±0.05pF	GQM1555G2D1R7WB01#	
			±2%	GQM1555C2D300GB01#				±0.1pF	GQM1555G2D1R7BB01#	
			±5%	GQM1555C2D300JB01#				±0.25pF	GQM1555G2D1R7CB01#	
		33pF	±1%	GQM1555C2D330FB01#			1.8pF	±0.05pF	GQM1555G2D1R8WB01#	
			±2%	GQM1555C2D330GB01#				±0.1pF	GQM1555G2D1R8BB01#	
			±5%	GQM1555C2D330JB01#				±0.25pF	GQM1555G2D1R8CB01#	
		X8G	0.10pF	±0.05pF			GQM1555G2DR10WB01#	1.9pF	±0.05pF	GQM1555G2D1R9WB01#
				±0.1pF			GQM1555G2DR10BB01#		±0.1pF	GQM1555G2D1R9BB01#
									±0.25pF	GQM1555G2D1R9CB01#
			0.20pF	±0.05pF			GQM1555G2DR20WB01#	2.0pF	±0.05pF	GQM1555G2D2R0WB01#
				±0.1pF			GQM1555G2DR20BB01#		±0.1pF	GQM1555G2D2R0BB01#
				±0.25pF			GQM1555G2DR20CB01#		±0.25pF	GQM1555G2D2R0CB01#
			0.30pF	±0.05pF			GQM1555G2DR30WB01#	2.1pF	±0.05pF	GQM1555G2D2R1WB01#
				±0.1pF			GQM1555G2DR30BB01#		±0.1pF	GQM1555G2D2R1BB01#
				±0.25pF			GQM1555G2DR30CB01#		±0.25pF	GQM1555G2D2R1CB01#
			0.40pF	±0.05pF			GQM1555G2DR40WB01#	2.2pF	±0.05pF	GQM1555G2D2R2WB01#
				±0.1pF			GQM1555G2DR40BB01#		±0.1pF	GQM1555G2D2R2BB01#
				±0.25pF			GQM1555G2DR40CB01#		±0.25pF	GQM1555G2D2R2CB01#
			0.50pF	±0.05pF			GQM1555G2DR50WB01#	2.3pF	±0.05pF	GQM1555G2D2R3WB01#
				±0.1pF			GQM1555G2DR50BB01#		±0.1pF	GQM1555G2D2R3BB01#
				±0.25pF			GQM1555G2DR50CB01#		±0.25pF	GQM1555G2D2R3CB01#
			0.60pF	±0.05pF			GQM1555G2DR60WB01#	2.4pF	±0.05pF	GQM1555G2D2R4WB01#
				±0.1pF			GQM1555G2DR60BB01#		±0.1pF	GQM1555G2D2R4BB01#
				±0.25pF			GQM1555G2DR60CB01#		±0.25pF	GQM1555G2D2R4CB01#
			0.70pF	±0.05pF			GQM1555G2DR70WB01#	2.5pF	±0.05pF	GQM1555G2D2R5WB01#
				±0.1pF			GQM1555G2DR70BB01#		±0.1pF	GQM1555G2D2R5BB01#
	±0.25pF			GQM1555G2DR70CB01#			±0.25pF		GQM1555G2D2R5CB01#	
	0.75pF		±0.05pF	GQM1555G2DR75WB01#			2.6pF	±0.05pF	GQM1555G2D2R6WB01#	
			±0.1pF	GQM1555G2DR75BB01#				±0.1pF	GQM1555G2D2R6BB01#	
			±0.25pF	GQM1555G2DR75CB01#				±0.25pF	GQM1555G2D2R6CB01#	
	0.80pF		±0.05pF	GQM1555G2DR80WB01#			2.7pF	±0.05pF	GQM1555G2D2R7WB01#	
			±0.1pF	GQM1555G2DR80BB01#				±0.1pF	GQM1555G2D2R7BB01#	
			±0.25pF	GQM1555G2DR80CB01#				±0.25pF	GQM1555G2D2R7CB01#	
	0.90pF		±0.05pF	GQM1555G2DR90WB01#			2.8pF	±0.05pF	GQM1555G2D2R8WB01#	
			±0.1pF	GQM1555G2DR90BB01#				±0.1pF	GQM1555G2D2R8BB01#	
±0.25pF			GQM1555G2DR90CB01#	±0.25pF	GQM1555G2D2R8CB01#					
1.0pF	±0.05pF		GQM1555G2D1R0WB01#	2.9pF	±0.05pF	GQM1555G2D2R9WB01#				
	±0.1pF		GQM1555G2D1R0BB01#		±0.1pF	GQM1555G2D2R9BB01#				
	±0.25pF		GQM1555G2D1R0CB01#		±0.25pF	GQM1555G2D2R9CB01#				
1.1pF	±0.05pF		GQM1555G2D1R1WB01#	3.0pF	±0.05pF	GQM1555G2D3R0WB01#				
	±0.1pF		GQM1555G2D1R1BB01#		±0.1pF	GQM1555G2D3R0BB01#				
	±0.25pF		GQM1555G2D1R1CB01#		±0.25pF	GQM1555G2D3R0CB01#				
1.2pF	±0.05pF		GQM1555G2D1R2WB01#	3.1pF	±0.05pF	GQM1555G2D3R1WB01#				
	±0.1pF		GQM1555G2D1R2BB01#		±0.1pF	GQM1555G2D3R1BB01#				
	±0.25pF		GQM1555G2D1R2CB01#		±0.1pF	GQM1555G2D3R1CB01#				
1.3pF	±0.05pF		GQM1555G2D1R3WB01#							
	±0.1pF		GQM1555G2D1R3BB01#							

Part number # indicates the package specification code.

GQM Series Temperature Compensating Type High Q Part Number List

(→ 1.0×0.5mm)

Rated Voltage	TC Code	Cap.	Tol.	Part Number	Rated Voltage	TC Code	Cap.	Tol.	Part Number		
200Vdc	X8G	3.1pF	±0.25pF	GQM1555G2D3R1CB01#	200Vdc	X8G	4.9pF	±0.25pF	GQM1555G2D4R9CB01#		
			3.2pF	±0.05pF				GQM1555G2D3R2WB01#	5.0pF	±0.05pF	GQM1555G2D5R0WB01#
				±0.1pF				GQM1555G2D3R2BB01#		±0.1pF	GQM1555G2D5R0BB01#
		±0.25pF		GQM1555G2D3R2CB01#			±0.25pF	GQM1555G2D5R0CB01#			
		3.3pF	±0.05pF	GQM1555G2D3R3WB01#			5.1pF	±0.05pF	GQM1555G2D5R1WB01#		
			±0.1pF	GQM1555G2D3R3BB01#				±0.1pF	GQM1555G2D5R1BB01#		
			±0.25pF	GQM1555G2D3R3CB01#				±0.25pF	GQM1555G2D5R1CB01#		
		3.4pF	±0.05pF	GQM1555G2D3R4WB01#			5.2pF	±0.05pF	GQM1555G2D5R2WB01#		
			±0.1pF	GQM1555G2D3R4BB01#				±0.1pF	GQM1555G2D5R2BB01#		
			±0.25pF	GQM1555G2D3R4CB01#				±0.25pF	GQM1555G2D5R2CB01#		
		3.5pF	±0.05pF	GQM1555G2D3R5WB01#			5.3pF	±0.05pF	GQM1555G2D5R3WB01#		
			±0.1pF	GQM1555G2D3R5BB01#				±0.1pF	GQM1555G2D5R3BB01#		
			±0.25pF	GQM1555G2D3R5CB01#				±0.25pF	GQM1555G2D5R3CB01#		
		3.6pF	±0.05pF	GQM1555G2D3R6WB01#			5.4pF	±0.05pF	GQM1555G2D5R4WB01#		
			±0.1pF	GQM1555G2D3R6BB01#				±0.1pF	GQM1555G2D5R4BB01#		
			±0.25pF	GQM1555G2D3R6CB01#				±0.25pF	GQM1555G2D5R4CB01#		
		3.7pF	±0.05pF	GQM1555G2D3R7WB01#			5.5pF	±0.05pF	GQM1555G2D5R5WB01#		
			±0.1pF	GQM1555G2D3R7BB01#				±0.1pF	GQM1555G2D5R5BB01#		
			±0.25pF	GQM1555G2D3R7CB01#				±0.25pF	GQM1555G2D5R5CB01#		
		3.8pF	±0.05pF	GQM1555G2D3R8WB01#			5.6pF	±0.05pF	GQM1555G2D5R6WB01#		
			±0.1pF	GQM1555G2D3R8BB01#				±0.1pF	GQM1555G2D5R6BB01#		
			±0.25pF	GQM1555G2D3R8CB01#				±0.25pF	GQM1555G2D5R6CB01#		
		3.9pF	±0.05pF	GQM1555G2D3R9WB01#			5.7pF	±0.05pF	GQM1555G2D5R7WB01#		
			±0.1pF	GQM1555G2D3R9BB01#				±0.1pF	GQM1555G2D5R7BB01#		
			±0.25pF	GQM1555G2D3R9CB01#				±0.25pF	GQM1555G2D5R7CB01#		
		4.0pF	±0.05pF	GQM1555G2D4R0WB01#			5.8pF	±0.05pF	GQM1555G2D5R8WB01#		
			±0.1pF	GQM1555G2D4R0BB01#				±0.1pF	GQM1555G2D5R8BB01#		
			±0.25pF	GQM1555G2D4R0CB01#				±0.25pF	GQM1555G2D5R8CB01#		
		4.1pF	±0.05pF	GQM1555G2D4R1WB01#			5.9pF	±0.05pF	GQM1555G2D5R9WB01#		
			±0.1pF	GQM1555G2D4R1BB01#				±0.1pF	GQM1555G2D5R9BB01#		
			±0.25pF	GQM1555G2D4R1CB01#				±0.25pF	GQM1555G2D5R9CB01#		
		4.2pF	±0.05pF	GQM1555G2D4R2WB01#			6.0pF	±0.05pF	GQM1555G2D6R0WB01#		
			±0.1pF	GQM1555G2D4R2BB01#				±0.1pF	GQM1555G2D6R0BB01#		
			±0.25pF	GQM1555G2D4R2CB01#				±0.25pF	GQM1555G2D6R0CB01#		
		4.3pF	±0.05pF	GQM1555G2D4R3WB01#			6.1pF	±0.05pF	GQM1555G2D6R1WB01#		
			±0.1pF	GQM1555G2D4R3BB01#				±0.1pF	GQM1555G2D6R1BB01#		
			±0.25pF	GQM1555G2D4R3CB01#				±0.25pF	GQM1555G2D6R1CB01#		
		4.4pF	±0.05pF	GQM1555G2D4R4WB01#			6.2pF	±0.05pF	GQM1555G2D6R2WB01#		
			±0.1pF	GQM1555G2D4R4BB01#				±0.1pF	GQM1555G2D6R2BB01#		
			±0.25pF	GQM1555G2D4R4CB01#				±0.25pF	GQM1555G2D6R2CB01#		
		4.5pF	±0.05pF	GQM1555G2D4R5WB01#			6.3pF	±0.05pF	GQM1555G2D6R3WB01#		
			±0.1pF	GQM1555G2D4R5BB01#				±0.1pF	GQM1555G2D6R3BB01#		
			±0.25pF	GQM1555G2D4R5CB01#				±0.25pF	GQM1555G2D6R3CB01#		
		4.6pF	±0.05pF	GQM1555G2D4R6WB01#			6.4pF	±0.05pF	GQM1555G2D6R4WB01#		
			±0.1pF	GQM1555G2D4R6BB01#				±0.1pF	GQM1555G2D6R4BB01#		
			±0.25pF	GQM1555G2D4R6CB01#				±0.25pF	GQM1555G2D6R4CB01#		
		4.7pF	±0.05pF	GQM1555G2D4R7WB01#			6.5pF	±0.05pF	GQM1555G2D6R5WB01#		
			±0.1pF	GQM1555G2D4R7BB01#				±0.1pF	GQM1555G2D6R5BB01#		
			±0.25pF	GQM1555G2D4R7CB01#				±0.25pF	GQM1555G2D6R5CB01#		
		4.8pF	±0.05pF	GQM1555G2D4R8WB01#			6.6pF	±0.05pF	GQM1555G2D6R6WB01#		
			±0.1pF	GQM1555G2D4R8BB01#				±0.1pF	GQM1555G2D6R6BB01#		
			±0.25pF	GQM1555G2D4R8CB01#				±0.25pF	GQM1555G2D6R6CB01#		
		4.9pF	±0.05pF	GQM1555G2D4R9WB01#			6.7pF	±0.05pF	GQM1555G2D6R7WB01#		
			±0.1pF	GQM1555G2D4R9BB01#				±0.1pF	GQM1555G2D6R7BB01#		

Part number # indicates the package specification code.

GRM
 GR3
 GRJ
 GR4
 GJM
GQM
 GA2
 GA3 GB
 GA3 GD
 GA3 GF
 LLL
 LLA
 LLM
 LLR
 NFM
 GJ4
 ZRA
 ZRB
 KRM
 KR3
 GMA
 GMD
 ⚠Caution /Notice

GQM Series Temperature Compensating Type High Q Part Number List

(→ 1.0×0.5mm)

Rated Voltage	TC Code	Cap.	Tol.	Part Number	Rated Voltage	TC Code	Cap.	Tol.	Part Number		
200Vdc	X8G	6.7pF	±0.25pF	GQM1555G2D6R7CB01#	200Vdc	X8G	8.5pF	±0.25pF	GQM1555G2D8R5CB01#		
			6.8pF	±0.05pF				GQM1555G2D6R8WB01#	8.6pF	±0.05pF	GQM1555G2D8R6WB01#
				±0.1pF				GQM1555G2D6R8BB01#		±0.1pF	GQM1555G2D8R6BB01#
		±0.25pF		GQM1555G2D6R8CB01#			±0.25pF	GQM1555G2D8R6CB01#			
		6.9pF	±0.05pF	GQM1555G2D6R9WB01#			8.7pF	±0.05pF	GQM1555G2D8R7WB01#		
			±0.1pF	GQM1555G2D6R9BB01#				±0.1pF	GQM1555G2D8R7BB01#		
			±0.25pF	GQM1555G2D6R9CB01#				±0.25pF	GQM1555G2D8R7CB01#		
		7.0pF	±0.05pF	GQM1555G2D7R0WB01#			8.8pF	±0.05pF	GQM1555G2D8R8WB01#		
			±0.1pF	GQM1555G2D7R0BB01#				±0.1pF	GQM1555G2D8R8BB01#		
			±0.25pF	GQM1555G2D7R0CB01#				±0.25pF	GQM1555G2D8R8CB01#		
		7.1pF	±0.05pF	GQM1555G2D7R1WB01#			8.9pF	±0.05pF	GQM1555G2D8R9WB01#		
			±0.1pF	GQM1555G2D7R1BB01#				±0.1pF	GQM1555G2D8R9BB01#		
			±0.25pF	GQM1555G2D7R1CB01#				±0.25pF	GQM1555G2D8R9CB01#		
		7.2pF	±0.05pF	GQM1555G2D7R2WB01#			9.0pF	±0.05pF	GQM1555G2D9R0WB01#		
			±0.1pF	GQM1555G2D7R2BB01#				±0.1pF	GQM1555G2D9R0BB01#		
			±0.25pF	GQM1555G2D7R2CB01#				±0.25pF	GQM1555G2D9R0CB01#		
		7.3pF	±0.05pF	GQM1555G2D7R3WB01#			9.1pF	±0.05pF	GQM1555G2D9R1WB01#		
			±0.1pF	GQM1555G2D7R3BB01#				±0.1pF	GQM1555G2D9R1BB01#		
			±0.25pF	GQM1555G2D7R3CB01#				±0.25pF	GQM1555G2D9R1CB01#		
		7.4pF	±0.05pF	GQM1555G2D7R4WB01#			9.2pF	±0.05pF	GQM1555G2D9R2WB01#		
			±0.1pF	GQM1555G2D7R4BB01#				±0.1pF	GQM1555G2D9R2BB01#		
			±0.25pF	GQM1555G2D7R4CB01#				±0.25pF	GQM1555G2D9R2CB01#		
		7.5pF	±0.05pF	GQM1555G2D7R5WB01#			9.3pF	±0.05pF	GQM1555G2D9R3WB01#		
			±0.1pF	GQM1555G2D7R5BB01#				±0.1pF	GQM1555G2D9R3BB01#		
			±0.25pF	GQM1555G2D7R5CB01#				±0.25pF	GQM1555G2D9R3CB01#		
		7.6pF	±0.05pF	GQM1555G2D7R6WB01#			9.4pF	±0.05pF	GQM1555G2D9R4WB01#		
			±0.1pF	GQM1555G2D7R6BB01#				±0.1pF	GQM1555G2D9R4BB01#		
			±0.25pF	GQM1555G2D7R6CB01#				±0.25pF	GQM1555G2D9R4CB01#		
		7.7pF	±0.05pF	GQM1555G2D7R7WB01#			9.5pF	±0.05pF	GQM1555G2D9R5WB01#		
			±0.1pF	GQM1555G2D7R7BB01#				±0.1pF	GQM1555G2D9R5BB01#		
			±0.25pF	GQM1555G2D7R7CB01#				±0.25pF	GQM1555G2D9R5CB01#		
		7.8pF	±0.05pF	GQM1555G2D7R8WB01#			9.6pF	±0.05pF	GQM1555G2D9R6WB01#		
			±0.1pF	GQM1555G2D7R8BB01#				±0.1pF	GQM1555G2D9R6BB01#		
			±0.25pF	GQM1555G2D7R8CB01#				±0.25pF	GQM1555G2D9R6CB01#		
		7.9pF	±0.05pF	GQM1555G2D7R9WB01#			9.7pF	±0.05pF	GQM1555G2D9R7WB01#		
			±0.1pF	GQM1555G2D7R9BB01#				±0.1pF	GQM1555G2D9R7BB01#		
			±0.25pF	GQM1555G2D7R9CB01#				±0.25pF	GQM1555G2D9R7CB01#		
		8.0pF	±0.05pF	GQM1555G2D8R0WB01#			9.8pF	±0.05pF	GQM1555G2D9R8WB01#		
			±0.1pF	GQM1555G2D8R0BB01#				±0.1pF	GQM1555G2D9R8BB01#		
			±0.25pF	GQM1555G2D8R0CB01#				±0.25pF	GQM1555G2D9R8CB01#		
		8.1pF	±0.05pF	GQM1555G2D8R1WB01#			9.9pF	±0.05pF	GQM1555G2D9R9WB01#		
			±0.1pF	GQM1555G2D8R1BB01#				±0.1pF	GQM1555G2D9R9BB01#		
			±0.25pF	GQM1555G2D8R1CB01#				±0.25pF	GQM1555G2D9R9CB01#		
		8.2pF	±0.05pF	GQM1555G2D8R2WB01#			10pF	±1%	GQM1555G2D100FB01#		
			±0.1pF	GQM1555G2D8R2BB01#				±2%	GQM1555G2D100GB01#		
			±0.25pF	GQM1555G2D8R2CB01#				±5%	GQM1555G2D100JB01#		
		8.3pF	±0.05pF	GQM1555G2D8R3WB01#			11pF	±1%	GQM1555G2D110FB01#		
			±0.1pF	GQM1555G2D8R3BB01#				±2%	GQM1555G2D110GB01#		
±0.25pF	GQM1555G2D8R3CB01#		±5%	GQM1555G2D110JB01#							
8.4pF	±0.05pF	GQM1555G2D8R4WB01#	12pF	±1%	GQM1555G2D120FB01#						
	±0.1pF	GQM1555G2D8R4BB01#		±2%	GQM1555G2D120GB01#						
	±0.25pF	GQM1555G2D8R4CB01#		±5%	GQM1555G2D120JB01#						
8.5pF	±0.05pF	GQM1555G2D8R5WB01#	13pF	±1%	GQM1555G2D130FB01#						
	±0.1pF	GQM1555G2D8R5BB01#		±2%	GQM1555G2D130GB01#						

Part number # indicates the package specification code.

GRM
 GR3
 GRJ
 GR4
 GJM
GQM
 GA2
 GA3 GB
 GA3 GD
 GA3 GF
 LLL
 LLA
 LLM
 LLR
 NFM
 GJ4
 ZRA
 ZRB
 KRM
 KR3
 GMA
 GMD
 ⚠Caution /Notice

GQM Series Temperature Compensating Type High Q Part Number List

(→ 1.0×0.5mm)

Rated Voltage	TC Code	Cap.	Tol.	Part Number	
200Vdc	X8G	13pF	±5%	GQM1555G2D130JB01#	
			±1%	GQM1555G2D150FB01#	
				±2%	GQM1555G2D150GB01#
				±5%	GQM1555G2D150JB01#
		16pF	±1%	GQM1555G2D160FB01#	
			±2%	GQM1555G2D160GB01#	
			±5%	GQM1555G2D160JB01#	
		18pF	±1%	GQM1555G2D180FB01#	
			±2%	GQM1555G2D180GB01#	
			±5%	GQM1555G2D180JB01#	
		20pF	±1%	GQM1555G2D200FB01#	
			±2%	GQM1555G2D200GB01#	
			±5%	GQM1555G2D200JB01#	
		22pF	±1%	GQM1555G2D220FB01#	
			±2%	GQM1555G2D220GB01#	
			±5%	GQM1555G2D220JB01#	
		24pF	±1%	GQM1555G2D240FB01#	
			±2%	GQM1555G2D240GB01#	
			±5%	GQM1555G2D240JB01#	
		27pF	±1%	GQM1555G2D270FB01#	
			±2%	GQM1555G2D270GB01#	
			±5%	GQM1555G2D270JB01#	
		30pF	±1%	GQM1555G2D300FB01#	
			±2%	GQM1555G2D300GB01#	
			±5%	GQM1555G2D300JB01#	
		33pF	±1%	GQM1555G2D330FB01#	
			±2%	GQM1555G2D330GB01#	
			±5%	GQM1555G2D330JB01#	

1.6×0.8mm

Rated Voltage	TC Code	Cap.	Tol.	Part Number
250Vdc	COG	0.10pF	±0.05pF	GQM1875C2ER10WB12#
			±0.1pF	GQM1875C2ER10BB12#
		0.20pF	±0.05pF	GQM1875C2ER20WB12#
			±0.1pF	GQM1875C2ER20BB12#
		0.30pF	±0.05pF	GQM1875C2ER30WB12#
			±0.1pF	GQM1875C2ER30BB12#
			±0.25pF	GQM1875C2ER30CB12#
		0.40pF	±0.05pF	GQM1875C2ER40WB12#
			±0.1pF	GQM1875C2ER40BB12#
			±0.25pF	GQM1875C2ER40CB12#
		0.50pF	±0.05pF	GQM1875C2ER50WB12#
			±0.1pF	GQM1875C2ER50BB12#
			±0.25pF	GQM1875C2ER50CB12#
			±0.5pF	GQM1875C2ER50DB12#
		0.60pF	±0.05pF	GQM1875C2ER60WB12#
			±0.1pF	GQM1875C2ER60BB12#
			±0.25pF	GQM1875C2ER60CB12#
			±0.5pF	GQM1875C2ER60DB12#
		0.70pF	±0.05pF	GQM1875C2ER70WB12#
			±0.1pF	GQM1875C2ER70BB12#
			±0.25pF	GQM1875C2ER70CB12#
			±0.5pF	GQM1875C2ER70DB12#

Rated Voltage	TC Code	Cap.	Tol.	Part Number
250Vdc	COG	0.70pF	±0.5pF	GQM1875C2ER70DB12#
			±0.05pF	GQM1875C2ER75WB12#
		0.75pF	±0.1pF	GQM1875C2ER75BB12#
			±0.25pF	GQM1875C2ER75CB12#
			±0.5pF	GQM1875C2ER75DB12#
			±0.05pF	GQM1875C2ER80WB12#
		0.80pF	±0.1pF	GQM1875C2ER80BB12#
			±0.25pF	GQM1875C2ER80CB12#
			±0.5pF	GQM1875C2ER80DB12#
		0.90pF	±0.05pF	GQM1875C2ER90WB12#
			±0.1pF	GQM1875C2ER90BB12#
			±0.25pF	GQM1875C2ER90CB12#
			±0.5pF	GQM1875C2ER90DB12#
		1.0pF	±0.05pF	GQM1875C2E1R0WB12#
			±0.1pF	GQM1875C2E1R0BB12#
			±0.25pF	GQM1875C2E1R0CB12#
			±0.5pF	GQM1875C2E1R0DB12#
		1.1pF	±0.05pF	GQM1875C2E1R1WB12#
			±0.1pF	GQM1875C2E1R1BB12#
			±0.25pF	GQM1875C2E1R1CB12#
		1.2pF	±0.05pF	GQM1875C2E1R1DB12#
			±0.1pF	GQM1875C2E1R2WB12#
			±0.25pF	GQM1875C2E1R2BB12#
		1.3pF	±0.05pF	GQM1875C2E1R2CB12#
			±0.1pF	GQM1875C2E1R2DB12#
			±0.25pF	GQM1875C2E1R3WB12#
			±0.5pF	GQM1875C2E1R3BB12#
		1.4pF	±0.05pF	GQM1875C2E1R3CB12#
			±0.1pF	GQM1875C2E1R3DB12#
			±0.25pF	GQM1875C2E1R4WB12#
			±0.5pF	GQM1875C2E1R4BB12#
		1.5pF	±0.05pF	GQM1875C2E1R4CB12#
			±0.1pF	GQM1875C2E1R4DB12#
			±0.25pF	GQM1875C2E1R5WB12#
			±0.5pF	GQM1875C2E1R5BB12#
		1.6pF	±0.05pF	GQM1875C2E1R5CB12#
			±0.1pF	GQM1875C2E1R5DB12#
			±0.25pF	GQM1875C2E1R6WB12#
			±0.5pF	GQM1875C2E1R6BB12#
		1.7pF	±0.05pF	GQM1875C2E1R6CB12#
			±0.1pF	GQM1875C2E1R6DB12#
			±0.25pF	GQM1875C2E1R7WB12#
		1.8pF	±0.05pF	GQM1875C2E1R7BB12#
			±0.1pF	GQM1875C2E1R7CB12#
			±0.25pF	GQM1875C2E1R7DB12#
			±0.5pF	GQM1875C2E1R8WB12#
		1.9pF	±0.05pF	GQM1875C2E1R8BB12#
			±0.1pF	GQM1875C2E1R8CB12#
			±0.25pF	GQM1875C2E1R8DB12#
		2.0pF	±0.05pF	GQM1875C2E1R9WB12#
			±0.1pF	GQM1875C2E1R9BB12#
			±0.25pF	GQM1875C2E1R9CB12#
		2.0pF	±0.05pF	GQM1875C2E1R9DB12#
			±0.1pF	GQM1875C2E1R9BB12#
			±0.25pF	GQM1875C2E1R9CB12#

Part number # indicates the package specification code.

GQM Series Temperature Compensating Type High Q Part Number List

(→ 1.6×0.8mm)

Rated Voltage	TC Code	Cap.	Tol.	Part Number	Rated Voltage	TC Code	Cap.	Tol.	Part Number	
250Vdc	COG	2.0pF	±0.1pF	GQM1875C2E2R0BB12#	250Vdc	COG	3.3pF	±0.5pF	GQM1875C2E3R3DB12#	
			±0.25pF	GQM1875C2E2R0CB12#				3.4pF	±0.05pF	GQM1875C2E3R4WB12#
			±0.5pF	GQM1875C2E2R0DB12#					±0.1pF	GQM1875C2E3R4BB12#
		±0.05pF	GQM1875C2E2R1WB12#	±0.25pF			GQM1875C2E3R4CB12#			
		2.1pF	±0.1pF	GQM1875C2E2R1BB12#			3.5pF	±0.5pF	GQM1875C2E3R4DB12#	
			±0.25pF	GQM1875C2E2R1CB12#				±0.05pF	GQM1875C2E3R5WB12#	
			±0.5pF	GQM1875C2E2R1DB12#				±0.1pF	GQM1875C2E3R5BB12#	
		2.2pF	±0.05pF	GQM1875C2E2R2WB12#			3.6pF	±0.25pF	GQM1875C2E3R5CB12#	
			±0.1pF	GQM1875C2E2R2BB12#				±0.5pF	GQM1875C2E3R5DB12#	
			±0.25pF	GQM1875C2E2R2CB12#				3.7pF	±0.05pF	GQM1875C2E3R6WB12#
			±0.5pF	GQM1875C2E2R2DB12#					±0.1pF	GQM1875C2E3R6BB12#
		±0.05pF	GQM1875C2E2R3WB12#	±0.25pF			GQM1875C2E3R6CB12#			
		2.3pF	±0.1pF	GQM1875C2E2R3BB12#			3.8pF	±0.5pF	GQM1875C2E3R6DB12#	
			±0.25pF	GQM1875C2E2R3CB12#				±0.05pF	GQM1875C2E3R7WB12#	
			±0.5pF	GQM1875C2E2R3DB12#				±0.1pF	GQM1875C2E3R7BB12#	
		2.4pF	±0.05pF	GQM1875C2E2R4WB12#			3.9pF	±0.25pF	GQM1875C2E3R7CB12#	
			±0.1pF	GQM1875C2E2R4BB12#				±0.5pF	GQM1875C2E3R7DB12#	
			±0.25pF	GQM1875C2E2R4CB12#				4.0pF	±0.05pF	GQM1875C2E3R8WB12#
			±0.5pF	GQM1875C2E2R4DB12#					±0.1pF	GQM1875C2E3R8BB12#
		±0.05pF	GQM1875C2E2R5WB12#	±0.25pF			GQM1875C2E3R8CB12#			
		2.5pF	±0.1pF	GQM1875C2E2R5BB12#			4.1pF	±0.5pF	GQM1875C2E3R8DB12#	
			±0.25pF	GQM1875C2E2R5CB12#				±0.05pF	GQM1875C2E3R9WB12#	
			±0.5pF	GQM1875C2E2R5DB12#				±0.1pF	GQM1875C2E3R9BB12#	
		2.6pF	±0.05pF	GQM1875C2E2R6WB12#			4.2pF	±0.25pF	GQM1875C2E3R9CB12#	
			±0.1pF	GQM1875C2E2R6BB12#				±0.5pF	GQM1875C2E3R9DB12#	
			±0.25pF	GQM1875C2E2R6CB12#				4.3pF	±0.05pF	GQM1875C2E4R0WB12#
			±0.5pF	GQM1875C2E2R6DB12#					±0.1pF	GQM1875C2E4R0BB12#
		±0.05pF	GQM1875C2E2R7WB12#	±0.25pF			GQM1875C2E4R0CB12#			
		2.7pF	±0.1pF	GQM1875C2E2R7BB12#			4.4pF	±0.5pF	GQM1875C2E4R0DB12#	
			±0.25pF	GQM1875C2E2R7CB12#				±0.05pF	GQM1875C2E4R1WB12#	
			±0.5pF	GQM1875C2E2R7DB12#				±0.1pF	GQM1875C2E4R1BB12#	
		2.8pF	±0.05pF	GQM1875C2E2R8WB12#			4.5pF	±0.25pF	GQM1875C2E4R1CB12#	
			±0.1pF	GQM1875C2E2R8BB12#				±0.5pF	GQM1875C2E4R1DB12#	
			±0.25pF	GQM1875C2E2R8CB12#				4.6pF	±0.05pF	GQM1875C2E4R2WB12#
			±0.5pF	GQM1875C2E2R8DB12#					±0.1pF	GQM1875C2E4R2BB12#
		±0.05pF	GQM1875C2E2R9WB12#	±0.25pF			GQM1875C2E4R2CB12#			
		2.9pF	±0.1pF	GQM1875C2E2R9BB12#			4.7pF	±0.5pF	GQM1875C2E4R2DB12#	
			±0.25pF	GQM1875C2E2R9CB12#				±0.05pF	GQM1875C2E4R3WB12#	
			±0.5pF	GQM1875C2E2R9DB12#				±0.1pF	GQM1875C2E4R3BB12#	
		3.0pF	±0.05pF	GQM1875C2E3R0WB12#			4.8pF	±0.25pF	GQM1875C2E4R3CB12#	
			±0.1pF	GQM1875C2E3R0BB12#				±0.5pF	GQM1875C2E4R3DB12#	
			±0.25pF	GQM1875C2E3R0CB12#				4.9pF	±0.05pF	GQM1875C2E4R4WB12#
			±0.5pF	GQM1875C2E3R0DB12#					±0.1pF	GQM1875C2E4R4BB12#
		±0.05pF	GQM1875C2E3R1WB12#	±0.25pF			GQM1875C2E4R4CB12#			
		3.1pF	±0.1pF	GQM1875C2E3R1BB12#			5.0pF	±0.5pF	GQM1875C2E4R4DB12#	
			±0.25pF	GQM1875C2E3R1CB12#				±0.05pF	GQM1875C2E4R5WB12#	
			±0.5pF	GQM1875C2E3R1DB12#				±0.1pF	GQM1875C2E4R5BB12#	
		3.2pF	±0.05pF	GQM1875C2E3R2WB12#			5.1pF	±0.25pF	GQM1875C2E4R5CB12#	
±0.1pF	GQM1875C2E3R2BB12#		±0.5pF	GQM1875C2E4R5DB12#						
±0.25pF	GQM1875C2E3R2CB12#		5.2pF	±0.05pF	GQM1875C2E4R6WB12#					
±0.5pF	GQM1875C2E3R2DB12#			±0.1pF	GQM1875C2E4R6BB12#					
±0.05pF	GQM1875C2E3R3WB12#	±0.25pF		GQM1875C2E4R6CB12#						
3.3pF	±0.1pF	GQM1875C2E3R3BB12#	5.3pF	±0.5pF	GQM1875C2E4R6DB12#					
	±0.25pF	GQM1875C2E3R3CB12#		±0.05pF	GQM1875C2E4R7WB12#					
				±0.1pF						

Part number # indicates the package specification code.

- GRM
- GR3
- GRJ
- GR4
- GJM
- GQM**
- GA2
- GA3 GB
- GA3 GD
- GA3 GF
- LLL
- LLA
- LLM
- LLR
- NFM
- GJ4
- ZRA
- ZRB
- KRM
- KR3
- GMA
- GMD
- ⚠Caution /Notice

GQM Series Temperature Compensating Type High Q Part Number List

(→ 1.6×0.8mm)

Rated Voltage	TC Code	Cap.	Tol.	Part Number	Rated Voltage	TC Code	Cap.	Tol.	Part Number	
250Vdc	COG	4.7pF	±0.1pF	GQM1875C2E4R7BB12#	250Vdc	COG	6.0pF	±0.5pF	GQM1875C2E6R0DB12#	
			±0.25pF	GQM1875C2E4R7CB12#				6.1pF	±0.05pF	GQM1875C2E6R1WB12#
			±0.5pF	GQM1875C2E4R7DB12#					±0.1pF	GQM1875C2E6R1BB12#
		±0.05pF	GQM1875C2E4R8WB12#	±0.25pF			GQM1875C2E6R1CB12#			
		4.8pF	±0.1pF	GQM1875C2E4R8BB12#			6.2pF	±0.5pF	GQM1875C2E6R1DB12#	
			±0.25pF	GQM1875C2E4R8CB12#				6.2pF	±0.05pF	GQM1875C2E6R2WB12#
			±0.5pF	GQM1875C2E4R8DB12#					±0.1pF	GQM1875C2E6R2BB12#
		4.9pF	±0.05pF	GQM1875C2E4R9WB12#			6.3pF		±0.25pF	GQM1875C2E6R2CB12#
			±0.1pF	GQM1875C2E4R9BB12#				±0.5pF	GQM1875C2E6R2DB12#	
			±0.25pF	GQM1875C2E4R9CB12#				6.3pF	±0.05pF	GQM1875C2E6R3WB12#
		±0.5pF	GQM1875C2E4R9DB12#	±0.1pF			GQM1875C2E6R3BB12#			
		5.0pF	±0.05pF	GQM1875C2E5R0WB12#			6.4pF		±0.25pF	GQM1875C2E6R3CB12#
			±0.1pF	GQM1875C2E5R0BB12#				±0.5pF	GQM1875C2E6R3DB12#	
			±0.25pF	GQM1875C2E5R0CB12#				6.4pF	±0.05pF	GQM1875C2E6R4WB12#
		±0.5pF	GQM1875C2E5R0DB12#	±0.1pF			GQM1875C2E6R4BB12#			
		5.1pF	±0.05pF	GQM1875C2E5R1WB12#			6.5pF		±0.25pF	GQM1875C2E6R4CB12#
			±0.1pF	GQM1875C2E5R1BB12#				±0.5pF	GQM1875C2E6R4DB12#	
			±0.25pF	GQM1875C2E5R1CB12#				6.5pF	±0.05pF	GQM1875C2E6R5WB12#
		±0.5pF	GQM1875C2E5R1DB12#	±0.1pF			GQM1875C2E6R5BB12#			
		5.2pF	±0.05pF	GQM1875C2E5R2WB12#			6.6pF		±0.25pF	GQM1875C2E6R5CB12#
			±0.1pF	GQM1875C2E5R2BB12#				±0.5pF	GQM1875C2E6R5DB12#	
			±0.25pF	GQM1875C2E5R2CB12#				6.6pF	±0.05pF	GQM1875C2E6R6WB12#
		±0.5pF	GQM1875C2E5R2DB12#	±0.1pF			GQM1875C2E6R6BB12#			
		5.3pF	±0.05pF	GQM1875C2E5R3WB12#			6.7pF		±0.25pF	GQM1875C2E6R6CB12#
			±0.1pF	GQM1875C2E5R3BB12#				±0.5pF	GQM1875C2E6R6DB12#	
			±0.25pF	GQM1875C2E5R3CB12#				6.7pF	±0.05pF	GQM1875C2E6R7WB12#
		±0.5pF	GQM1875C2E5R3DB12#	±0.1pF			GQM1875C2E6R7BB12#			
		5.4pF	±0.05pF	GQM1875C2E5R4WB12#			6.8pF		±0.25pF	GQM1875C2E6R7CB12#
			±0.1pF	GQM1875C2E5R4BB12#				±0.5pF	GQM1875C2E6R7DB12#	
			±0.25pF	GQM1875C2E5R4CB12#				6.8pF	±0.05pF	GQM1875C2E6R8WB12#
		±0.5pF	GQM1875C2E5R4DB12#	±0.1pF			GQM1875C2E6R8BB12#			
		5.5pF	±0.05pF	GQM1875C2E5R5WB12#			6.9pF		±0.25pF	GQM1875C2E6R8CB12#
			±0.1pF	GQM1875C2E5R5BB12#				±0.5pF	GQM1875C2E6R8DB12#	
			±0.25pF	GQM1875C2E5R5CB12#				6.9pF	±0.05pF	GQM1875C2E6R9WB12#
		±0.5pF	GQM1875C2E5R5DB12#	±0.1pF			GQM1875C2E6R9BB12#			
		5.6pF	±0.05pF	GQM1875C2E5R6WB12#			7.0pF		±0.25pF	GQM1875C2E6R9CB12#
			±0.1pF	GQM1875C2E5R6BB12#				±0.5pF	GQM1875C2E6R9DB12#	
			±0.25pF	GQM1875C2E5R6CB12#				7.0pF	±0.05pF	GQM1875C2E7R0WB12#
		±0.5pF	GQM1875C2E5R6DB12#	±0.1pF			GQM1875C2E7R0BB12#			
		5.7pF	±0.05pF	GQM1875C2E5R7WB12#			7.1pF		±0.25pF	GQM1875C2E7R0CB12#
			±0.1pF	GQM1875C2E5R7BB12#				±0.5pF	GQM1875C2E7R0DB12#	
			±0.25pF	GQM1875C2E5R7CB12#				7.1pF	±0.05pF	GQM1875C2E7R1WB12#
		±0.5pF	GQM1875C2E5R7DB12#	±0.1pF			GQM1875C2E7R1BB12#			
		5.8pF	±0.05pF	GQM1875C2E5R8WB12#			7.2pF		±0.25pF	GQM1875C2E7R1CB12#
			±0.1pF	GQM1875C2E5R8BB12#				±0.5pF	GQM1875C2E7R1DB12#	
			±0.25pF	GQM1875C2E5R8CB12#				7.2pF	±0.05pF	GQM1875C2E7R2WB12#
		±0.5pF	GQM1875C2E5R8DB12#	±0.1pF			GQM1875C2E7R2BB12#			
		5.9pF	±0.05pF	GQM1875C2E5R9WB12#			7.3pF		±0.25pF	GQM1875C2E7R2CB12#
			±0.1pF	GQM1875C2E5R9BB12#				±0.5pF	GQM1875C2E7R2DB12#	
			±0.25pF	GQM1875C2E5R9CB12#				7.3pF	±0.05pF	GQM1875C2E7R3WB12#
		±0.5pF	GQM1875C2E5R9DB12#	±0.1pF			GQM1875C2E7R3BB12#			
		6.0pF	±0.05pF	GQM1875C2E6R0WB12#			7.4pF		±0.25pF	GQM1875C2E7R3CB12#
			±0.1pF	GQM1875C2E6R0BB12#				±0.5pF	GQM1875C2E7R3DB12#	
			±0.25pF	GQM1875C2E6R0CB12#				GQM1875C2E7R4WB12#		

- GRM
- GR3
- GRJ
- GR4
- GJM
- GQM**
- GA2
- GA3 GB
- GA3 GD
- GA3 GF
- LLL
- LLA
- LLM
- LLR
- NFM
- GJ4
- ZRA
- ZRB
- KRM
- KR3
- GMA
- GMD
- ⚠Caution /Notice

Part number # indicates the package specification code.

GQM Series Temperature Compensating Type High Q Part Number List

(→ 1.6×0.8mm)

Rated Voltage	TC Code	Cap.	Tol.	Part Number	Rated Voltage	TC Code	Cap.	Tol.	Part Number	
250Vdc	COG	7.4pF	±0.1pF	GQM1875C2E7R4BB12#	250Vdc	COG	8.7pF	±0.5pF	GQM1875C2E8R7DB12#	
			±0.25pF	GQM1875C2E7R4CB12#				8.8pF	±0.05pF	GQM1875C2E8R8WB12#
			±0.5pF	GQM1875C2E7R4DB12#					±0.1pF	GQM1875C2E8R8BB12#
		7.5pF	±0.05pF	GQM1875C2E7R5WB12#			±0.25pF		GQM1875C2E8R8CB12#	
			±0.1pF	GQM1875C2E7R5BB12#			±0.5pF	GQM1875C2E8R8DB12#		
			±0.25pF	GQM1875C2E7R5CB12#			8.9pF	±0.05pF	GQM1875C2E8R9WB12#	
		±0.5pF	GQM1875C2E7R5DB12#	±0.1pF				GQM1875C2E8R9BB12#		
		7.6pF	±0.05pF	GQM1875C2E7R6WB12#				±0.25pF	GQM1875C2E8R9CB12#	
			±0.1pF	GQM1875C2E7R6BB12#			±0.5pF	GQM1875C2E8R9DB12#		
			±0.25pF	GQM1875C2E7R6CB12#			9.0pF	±0.05pF	GQM1875C2E9R0WB12#	
		±0.5pF	GQM1875C2E7R6DB12#	±0.1pF				GQM1875C2E9R0BB12#		
		7.7pF	±0.05pF	GQM1875C2E7R7WB12#				±0.25pF	GQM1875C2E9R0CB12#	
			±0.1pF	GQM1875C2E7R7BB12#			±0.5pF	GQM1875C2E9R0DB12#		
			±0.25pF	GQM1875C2E7R7CB12#			9.1pF	±0.05pF	GQM1875C2E9R1WB12#	
		±0.5pF	GQM1875C2E7R7DB12#	±0.1pF				GQM1875C2E9R1BB12#		
		7.8pF	±0.05pF	GQM1875C2E7R8WB12#				±0.25pF	GQM1875C2E9R1CB12#	
			±0.1pF	GQM1875C2E7R8BB12#			±0.5pF	GQM1875C2E9R1DB12#		
			±0.25pF	GQM1875C2E7R8CB12#			9.2pF	±0.1pF	GQM1875C2E9R2BB12#	
		±0.5pF	GQM1875C2E7R8DB12#	±0.25pF				GQM1875C2E9R2CB12#		
		7.9pF	±0.05pF	GQM1875C2E7R9WB12#				±0.5pF	GQM1875C2E9R2DB12#	
			±0.1pF	GQM1875C2E7R9BB12#			9.3pF	±0.1pF	GQM1875C2E9R3BB12#	
			±0.25pF	GQM1875C2E7R9CB12#				±0.25pF	GQM1875C2E9R3CB12#	
		±0.5pF	GQM1875C2E7R9DB12#	±0.5pF				GQM1875C2E9R3DB12#		
		8.0pF	±0.05pF	GQM1875C2E8R0WB12#			9.4pF	±0.1pF	GQM1875C2E9R4BB12#	
			±0.1pF	GQM1875C2E8R0BB12#				±0.25pF	GQM1875C2E9R4CB12#	
			±0.25pF	GQM1875C2E8R0CB12#				±0.5pF	GQM1875C2E9R4DB12#	
		8.1pF	±0.05pF	GQM1875C2E8R1WB12#			9.5pF	±0.1pF	GQM1875C2E9R5BB12#	
			±0.1pF	GQM1875C2E8R1BB12#				±0.25pF	GQM1875C2E9R5CB12#	
			±0.25pF	GQM1875C2E8R1CB12#				±0.5pF	GQM1875C2E9R5DB12#	
		8.2pF	±0.05pF	GQM1875C2E8R2WB12#			9.6pF	±0.1pF	GQM1875C2E9R6BB12#	
			±0.1pF	GQM1875C2E8R2BB12#				±0.25pF	GQM1875C2E9R6CB12#	
			±0.25pF	GQM1875C2E8R2CB12#				±0.5pF	GQM1875C2E9R6DB12#	
		8.3pF	±0.05pF	GQM1875C2E8R3WB12#			9.7pF	±0.1pF	GQM1875C2E9R7BB12#	
			±0.1pF	GQM1875C2E8R3BB12#				±0.25pF	GQM1875C2E9R7CB12#	
			±0.25pF	GQM1875C2E8R3CB12#				±0.5pF	GQM1875C2E9R7DB12#	
		8.4pF	±0.05pF	GQM1875C2E8R3DB12#			9.8pF	±0.1pF	GQM1875C2E9R8BB12#	
			±0.1pF	GQM1875C2E8R3BB12#				±0.25pF	GQM1875C2E9R8CB12#	
			±0.25pF	GQM1875C2E8R3CB12#				±0.5pF	GQM1875C2E9R8DB12#	
		8.5pF	±0.05pF	GQM1875C2E8R4WB12#			9.9pF	±0.1pF	GQM1875C2E9R9BB12#	
			±0.1pF	GQM1875C2E8R4BB12#				±0.25pF	GQM1875C2E9R9CB12#	
			±0.25pF	GQM1875C2E8R4CB12#				±0.5pF	GQM1875C2E9R9DB12#	
		8.6pF	±0.05pF	GQM1875C2E8R4DB12#			10pF	±1%	GQM1875C2E100FB12#	
			±0.1pF	GQM1875C2E8R4BB12#				±2%	GQM1875C2E100GB12#	
			±0.25pF	GQM1875C2E8R4CB12#				±2.5%	GQM1875C2E100RB12#	
		8.7pF	±0.05pF	GQM1875C2E8R5WB12#			11pF	±5%	GQM1875C2E100JB12#	
			±0.1pF	GQM1875C2E8R5BB12#				12pF	±1%	GQM1875C2E110FB12#
			±0.25pF	GQM1875C2E8R5CB12#					±2%	GQM1875C2E110GB12#
		±0.5pF	GQM1875C2E8R5DB12#	±5%			GQM1875C2E110JB12#			
		8.8pF	±0.05pF	GQM1875C2E8R6WB12#			13pF	±1%	GQM1875C2E120FB12#	
			±0.1pF	GQM1875C2E8R6BB12#				±2%	GQM1875C2E120GB12#	
			±0.25pF	GQM1875C2E8R6CB12#				±5%	GQM1875C2E120JB12#	
		8.9pF	±0.05pF	GQM1875C2E8R6DB12#			13pF	±1%	GQM1875C2E130FB12#	
			±0.1pF	GQM1875C2E8R7WB12#				±2%	GQM1875C2E130GB12#	
			±0.25pF	GQM1875C2E8R7CB12#				±5%	GQM1875C2E130JB12#	

Part number # indicates the package specification code.

- GRM
- GR3
- GRJ
- GR4
- GJM
- GQM**
- GA2
- GA3 GB
- GA3 GD
- GA3 GF
- LLL
- LLA
- LLM
- LLR
- NFM
- GJ4
- ZRA
- ZRB
- KRM
- KR3
- GMA
- GMD
- ⚠Caution /Notice

GQM Series Temperature Compensating Type High Q Part Number List

(→ 1.6×0.8mm)

Rated Voltage	TC Code	Cap.	Tol.	Part Number		Rated Voltage	TC Code	Cap.	Tol.	Part Number				
250Vdc	COG	15pF	±1%	GQM1875C2E150FB12#		250Vdc	COG	82pF	±1%	GQM1875C2E820FB12#				
			±2%	GQM1875C2E150GB12#					±2%	GQM1875C2E820GB12#				
			±5%	GQM1875C2E150JB12#					±5%	GQM1875C2E820JB12#				
		16pF	±1%	GQM1875C2E160FB12#					91pF	±1%	GQM1875C2E910FB12#			
			±2%	GQM1875C2E160GB12#						±2%	GQM1875C2E910GB12#			
			±5%	GQM1875C2E160JB12#						±5%	GQM1875C2E910JB12#			
		18pF	±1%	GQM1875C2E180FB12#						100pF	±1%	GQM1875C2E101FB12#		
			±2%	GQM1875C2E180GB12#							±2%	GQM1875C2E101GB12#		
			±5%	GQM1875C2E180JB12#							±5%	GQM1875C2E101JB12#		
		20pF	±1%	GQM1875C2E200FB12#				CH			11pF	±1%	GQM1872C2E110FB12#	
			±2%	GQM1875C2E200GB12#								±2%	GQM1872C2E110GB12#	
			±5%	GQM1875C2E200JB12#								±5%	GQM1872C2E110JB12#	
		22pF	±1%	GQM1875C2E220FB12#					12pF		±1%	GQM1872C2E120FB12#		
			±2%	GQM1875C2E220GB12#							±2%	GQM1872C2E120GB12#		
			±5%	GQM1875C2E220JB12#							±5%	GQM1872C2E120JB12#		
		24pF	±1%	GQM1875C2E240FB12#						13pF	±1%	GQM1872C2E130FB12#		
			±2%	GQM1875C2E240GB12#							±2%	GQM1872C2E130GB12#		
			±5%	GQM1875C2E240JB12#							±5%	GQM1872C2E130JB12#		
		27pF	±1%	GQM1875C2E270FB12#				15pF			±1%	GQM1872C2E150FB12#		
			±2%	GQM1875C2E270GB12#							±2%	GQM1872C2E150GB12#		
			±5%	GQM1875C2E270JB12#							±5%	GQM1872C2E150JB12#		
		30pF	±1%	GQM1875C2E300FB12#					16pF		±1%	GQM1872C2E160FB12#		
			±2%	GQM1875C2E300GB12#							±2%	GQM1872C2E160GB12#		
			±5%	GQM1875C2E300JB12#							±5%	GQM1872C2E160JB12#		
		33pF	±1%	GQM1875C2E330FB12#						18pF	±1%	GQM1872C2E180FB12#		
			±2%	GQM1875C2E330GB12#							±2%	GQM1872C2E180GB12#		
			±5%	GQM1875C2E330JB12#							±5%	GQM1872C2E180JB12#		
		36pF	±1%	GQM1875C2E360FB12#				20pF			±1%	GQM1872C2E200FB12#		
			±2%	GQM1875C2E360GB12#							±2%	GQM1872C2E200GB12#		
			±5%	GQM1875C2E360JB12#							±5%	GQM1872C2E200JB12#		
		39pF	±1%	GQM1875C2E390FB12#					22pF		±1%	GQM1872C2E220FB12#		
			±2%	GQM1875C2E390GB12#							±2%	GQM1872C2E220GB12#		
			±5%	GQM1875C2E390JB12#							±5%	GQM1872C2E220JB12#		
		43pF	±1%	GQM1875C2E430FB12#						24pF	±1%	GQM1872C2E240FB12#		
			±2%	GQM1875C2E430GB12#							±2%	GQM1872C2E240GB12#		
			±5%	GQM1875C2E430JB12#							±5%	GQM1872C2E240JB12#		
		47pF	±1%	GQM1875C2E470FB12#				27pF			±1%	GQM1872C2E270FB12#		
			±2%	GQM1875C2E470GB12#							±2%	GQM1872C2E270GB12#		
			±5%	GQM1875C2E470JB12#							±5%	GQM1872C2E270JB12#		
		51pF	±1%	GQM1875C2E510FB12#					30pF		±1%	GQM1872C2E300FB12#		
			±2%	GQM1875C2E510GB12#							±2%	GQM1872C2E300GB12#		
			±5%	GQM1875C2E510JB12#							±5%	GQM1872C2E300JB12#		
		56pF	±1%	GQM1875C2E560FB12#						33pF	±1%	GQM1872C2E330FB12#		
			±2%	GQM1875C2E560GB12#							±2%	GQM1872C2E330GB12#		
			±5%	GQM1875C2E560JB12#							±5%	GQM1872C2E330JB12#		
		62pF	±1%	GQM1875C2E620FB12#				36pF			±1%	GQM1872C2E360FB12#		
			±2%	GQM1875C2E620GB12#							±2%	GQM1872C2E360GB12#		
			±5%	GQM1875C2E620JB12#							±5%	GQM1872C2E360JB12#		
		68pF	±1%	GQM1875C2E680FB12#					39pF		±1%	GQM1872C2E390FB12#		
			±2%	GQM1875C2E680GB12#							±2%	GQM1872C2E390GB12#		
			±5%	GQM1875C2E680JB12#							±5%	GQM1872C2E390JB12#		
		75pF	±1%	GQM1875C2E750FB12#						43pF	±1%	GQM1872C2E430FB12#		
			±2%	GQM1875C2E750GB12#							±2%	GQM1872C2E430GB12#		
			±5%	GQM1875C2E750JB12#							±5%	GQM1872C2E430JB12#		

Part number # indicates the package specification code.

GQM Series Temperature Compensating Type High Q Part Number List

(→ 1.6×0.8mm)

Rated Voltage	TC Code	Cap.	Tol.	Part Number	Rated Voltage	TC Code	Cap.	Tol.	Part Number				
250Vdc	CH	47pF	±1%	GQM1872C2E470FB12#	250Vdc	X8G	1.4pF	±0.1pF	GQM1875G2E1R4BB12#				
			±2%	GQM1872C2E470GB12#				±0.25pF	GQM1875G2E1R4CB12#				
			±5%	GQM1872C2E470JB12#				±0.5pF	GQM1875G2E1R4DB12#				
	X8G	0.10pF	±0.05pF	GQM1875G2ER10WB12#			1.5pF	±0.05pF	GQM1875G2E1R5WB12#	±0.1pF	GQM1875G2E1R5BB12#		
			±0.1pF	GQM1875G2ER10BB12#				±0.25pF	GQM1875G2E1R5CB12#	±0.5pF	GQM1875G2E1R5DB12#		
		0.20pF	±0.05pF	GQM1875G2ER20WB12#			1.6pF	±0.05pF	GQM1875G2E1R6WB12#	±0.1pF	GQM1875G2E1R6BB12#		
			±0.1pF	GQM1875G2ER20BB12#				±0.25pF	GQM1875G2E1R6CB12#	±0.5pF	GQM1875G2E1R6DB12#		
			±0.25pF	GQM1875G2ER30CB12#				1.7pF	±0.05pF	GQM1875G2E1R7WB12#	±0.1pF	GQM1875G2E1R7BB12#	
		±0.05pF	GQM1875G2ER40WB12#	±0.25pF			GQM1875G2E1R7CB12#		±0.5pF	GQM1875G2E1R7DB12#			
		±0.1pF	GQM1875G2ER40BB12#	1.8pF			±0.05pF		GQM1875G2E1R8WB12#	±0.1pF	GQM1875G2E1R8BB12#		
		±0.25pF	GQM1875G2ER40CB12#				±0.25pF	GQM1875G2E1R8CB12#	±0.5pF	GQM1875G2E1R8DB12#			
		±0.05pF	GQM1875G2ER50WB12#				1.9pF	±0.05pF	GQM1875G2E1R9WB12#	±0.1pF	GQM1875G2E1R9BB12#		
		±0.1pF	GQM1875G2ER50BB12#	±0.25pF				GQM1875G2E1R9CB12#	±0.5pF	GQM1875G2E1R9DB12#			
		±0.25pF	GQM1875G2ER50CB12#	2.0pF				±0.05pF	GQM1875G2E1R0WB12#	±0.1pF	GQM1875G2E2R0BB12#		
		±0.5pF	GQM1875G2ER50DB12#				±0.25pF	GQM1875G2E2R0CB12#	±0.5pF	GQM1875G2E2R0DB12#			
		±0.05pF	GQM1875G2ER60WB12#				2.1pF	±0.05pF	GQM1875G2E2R1WB12#	±0.1pF	GQM1875G2E2R1BB12#		
		±0.1pF	GQM1875G2ER60BB12#	±0.25pF				GQM1875G2E2R1CB12#	±0.5pF	GQM1875G2E2R1DB12#			
		±0.25pF	GQM1875G2ER60CB12#	2.2pF				±0.05pF	GQM1875G2E2R2WB12#	±0.1pF	GQM1875G2E2R2BB12#		
		±0.5pF	GQM1875G2ER60DB12#				±0.25pF	GQM1875G2E2R2CB12#	±0.5pF	GQM1875G2E2R2DB12#			
		±0.05pF	GQM1875G2ER70WB12#				2.3pF	±0.05pF	GQM1875G2E2R3WB12#	±0.1pF	GQM1875G2E2R3BB12#		
		±0.1pF	GQM1875G2ER70BB12#	±0.25pF				GQM1875G2E2R3CB12#	±0.5pF	GQM1875G2E2R3DB12#			
		±0.25pF	GQM1875G2ER70CB12#	2.4pF				±0.05pF	GQM1875G2E2R4WB12#	±0.1pF	GQM1875G2E2R4BB12#		
		±0.5pF	GQM1875G2ER70DB12#				±0.25pF	GQM1875G2E2R4CB12#	±0.5pF	GQM1875G2E2R4DB12#			
		±0.05pF	GQM1875G2ER75WB12#				2.5pF	±0.05pF	GQM1875G2E2R5WB12#	±0.1pF	GQM1875G2E2R5BB12#		
		±0.1pF	GQM1875G2ER75BB12#	±0.25pF				GQM1875G2E2R5CB12#	±0.5pF	GQM1875G2E2R5DB12#			
		±0.25pF	GQM1875G2ER75CB12#	2.6pF				±0.05pF	GQM1875G2E2R6WB12#	±0.1pF	GQM1875G2E2R6BB12#		
		±0.5pF	GQM1875G2ER75DB12#				±0.25pF	GQM1875G2E2R6CB12#	±0.5pF	GQM1875G2E2R6DB12#			
	±0.05pF	GQM1875G2ER80WB12#	2.7pF				±0.05pF	GQM1875G2E2R7WB12#	±0.1pF	GQM1875G2E2R7BB12#			
	±0.1pF	GQM1875G2ER80BB12#		±0.25pF			GQM1875G2E2R7CB12#	±0.5pF	GQM1875G2E2R7DB12#				
	±0.25pF	GQM1875G2ER80CB12#		0.90pF			±0.05pF	GQM1875G2ER90WB12#					
	±0.1pF	GQM1875G2ER90BB12#	1.0pF				±0.1pF	GQM1875G2E1R0WB12#					
	±0.25pF	GQM1875G2ER90CB12#					±0.1pF	GQM1875G2E1R0BB12#					
	±0.5pF	GQM1875G2ER90DB12#		±0.25pF			GQM1875G2E1R0CB12#						
	1.0pF	±0.05pF	GQM1875G2E1R0WB12#	1.1pF			±0.05pF	GQM1875G2E1R1WB12#					
		±0.1pF	GQM1875G2E1R0BB12#				±0.1pF	GQM1875G2E1R1BB12#					
		±0.25pF	GQM1875G2E1R0CB12#				±0.25pF	GQM1875G2E1R1CB12#					
	1.1pF	±0.1pF	GQM1875G2E1R1WB12#	1.2pF			±0.05pF	GQM1875G2E1R2WB12#					
		±0.25pF	GQM1875G2E1R1CB12#				±0.1pF	GQM1875G2E1R2BB12#					
		±0.5pF	GQM1875G2E1R1DB12#				±0.25pF	GQM1875G2E1R2CB12#					
	1.2pF	±0.05pF	GQM1875G2E1R2WB12#	1.3pF			±0.05pF	GQM1875G2E1R3WB12#					
		±0.1pF	GQM1875G2E1R2BB12#				±0.1pF	GQM1875G2E1R3BB12#					
		±0.25pF	GQM1875G2E1R2CB12#				±0.25pF	GQM1875G2E1R3CB12#					
	1.3pF	±0.1pF	GQM1875G2E1R2DB12#	1.4pF			±0.05pF	GQM1875G2E1R4WB12#					
		±0.25pF	GQM1875G2E1R2CB12#										
		±0.5pF	GQM1875G2E1R2DB12#										

GRM
GR3
GRJ
GR4
GJM
GQM
GA2
GA3 GB
GA3 GD
GA3 GF
LLL
LLA
LLM
LLR
NFM
GJ4
ZRA
ZRB
KRM
KR3
GMA
GMD
⚠Caution /Notice

Part number # indicates the package specification code.

GQM Series Temperature Compensating Type High Q Part Number List

(→ 1.6×0.8mm)

Rated Voltage	TC Code	Cap.	Tol.	Part Number	Rated Voltage	TC Code	Cap.	Tol.	Part Number
250Vdc	X8G	2.7pF	±0.5pF	GQM1875G2E2R7DB12#	250Vdc	X8G	4.1pF	±0.1pF	GQM1875G2E4R1BB12#
			±0.05pF	GQM1875G2E2R8WB12#				±0.25pF	GQM1875G2E4R1CB12#
			±0.1pF	GQM1875G2E2R8BB12#				±0.5pF	GQM1875G2E4R1DB12#
			±0.25pF	GQM1875G2E2R8CB12#				4.2pF	±0.05pF
		±0.5pF	GQM1875G2E2R8DB12#	±0.1pF			GQM1875G2E4R2BB12#		
		2.9pF	±0.05pF	GQM1875G2E2R9WB12#			±0.25pF		GQM1875G2E4R2CB12#
			±0.1pF	GQM1875G2E2R9BB12#			±0.5pF		GQM1875G2E4R2DB12#
			±0.25pF	GQM1875G2E2R9CB12#			4.3pF	±0.05pF	GQM1875G2E4R3WB12#
			±0.5pF	GQM1875G2E2R9DB12#				±0.1pF	GQM1875G2E4R3BB12#
		3.0pF	±0.05pF	GQM1875G2E3R0WB12#				±0.25pF	GQM1875G2E4R3CB12#
			±0.1pF	GQM1875G2E3R0BB12#				±0.5pF	GQM1875G2E4R3DB12#
			±0.25pF	GQM1875G2E3R0CB12#			4.4pF	±0.05pF	GQM1875G2E4R4WB12#
			±0.5pF	GQM1875G2E3R0DB12#				±0.1pF	GQM1875G2E4R4BB12#
		3.1pF	±0.05pF	GQM1875G2E3R1WB12#				±0.25pF	GQM1875G2E4R4CB12#
			±0.1pF	GQM1875G2E3R1BB12#				±0.5pF	GQM1875G2E4R4DB12#
			±0.25pF	GQM1875G2E3R1CB12#			4.5pF	±0.05pF	GQM1875G2E4R5WB12#
			±0.5pF	GQM1875G2E3R1DB12#				±0.1pF	GQM1875G2E4R5BB12#
		3.2pF	±0.05pF	GQM1875G2E3R2WB12#				±0.25pF	GQM1875G2E4R5CB12#
			±0.1pF	GQM1875G2E3R2BB12#				±0.5pF	GQM1875G2E4R5DB12#
			±0.25pF	GQM1875G2E3R2CB12#			4.6pF	±0.05pF	GQM1875G2E4R6WB12#
			±0.5pF	GQM1875G2E3R2DB12#				±0.1pF	GQM1875G2E4R6BB12#
		3.3pF	±0.05pF	GQM1875G2E3R3WB12#				±0.25pF	GQM1875G2E4R6CB12#
			±0.1pF	GQM1875G2E3R3BB12#				±0.5pF	GQM1875G2E4R6DB12#
			±0.25pF	GQM1875G2E3R3CB12#			4.7pF	±0.05pF	GQM1875G2E4R7WB12#
			±0.5pF	GQM1875G2E3R3DB12#				±0.1pF	GQM1875G2E4R7BB12#
		3.4pF	±0.05pF	GQM1875G2E3R4WB12#				±0.25pF	GQM1875G2E4R7CB12#
			±0.1pF	GQM1875G2E3R4BB12#				±0.5pF	GQM1875G2E4R7DB12#
			±0.25pF	GQM1875G2E3R4CB12#			4.8pF	±0.05pF	GQM1875G2E4R8WB12#
			±0.5pF	GQM1875G2E3R4DB12#				±0.1pF	GQM1875G2E4R8BB12#
		3.5pF	±0.05pF	GQM1875G2E3R5WB12#				±0.25pF	GQM1875G2E4R8CB12#
			±0.1pF	GQM1875G2E3R5BB12#				±0.5pF	GQM1875G2E4R8DB12#
			±0.25pF	GQM1875G2E3R5CB12#			4.9pF	±0.05pF	GQM1875G2E4R9WB12#
			±0.5pF	GQM1875G2E3R5DB12#				±0.1pF	GQM1875G2E4R9BB12#
		3.6pF	±0.05pF	GQM1875G2E3R6WB12#				±0.25pF	GQM1875G2E4R9CB12#
			±0.1pF	GQM1875G2E3R6BB12#				±0.5pF	GQM1875G2E4R9DB12#
			±0.25pF	GQM1875G2E3R6CB12#			5.0pF	±0.05pF	GQM1875G2E5R0WB12#
			±0.5pF	GQM1875G2E3R6DB12#				±0.1pF	GQM1875G2E5R0BB12#
		3.7pF	±0.05pF	GQM1875G2E3R7WB12#				±0.25pF	GQM1875G2E5R0CB12#
			±0.1pF	GQM1875G2E3R7BB12#				±0.5pF	GQM1875G2E5R0DB12#
			±0.25pF	GQM1875G2E3R7CB12#			5.1pF	±0.05pF	GQM1875G2E5R1WB12#
			±0.5pF	GQM1875G2E3R7DB12#				±0.1pF	GQM1875G2E5R1BB12#
		3.8pF	±0.05pF	GQM1875G2E3R8WB12#				±0.25pF	GQM1875G2E5R1CB12#
			±0.1pF	GQM1875G2E3R8BB12#				±0.5pF	GQM1875G2E5R1DB12#
			±0.25pF	GQM1875G2E3R8CB12#			5.2pF	±0.05pF	GQM1875G2E5R2WB12#
			±0.5pF	GQM1875G2E3R8DB12#				±0.1pF	GQM1875G2E5R2BB12#
		3.9pF	±0.05pF	GQM1875G2E3R9WB12#				±0.25pF	GQM1875G2E5R2CB12#
			±0.1pF	GQM1875G2E3R9BB12#				±0.5pF	GQM1875G2E5R2DB12#
			±0.25pF	GQM1875G2E3R9CB12#			5.3pF	±0.05pF	GQM1875G2E5R3WB12#
			±0.5pF	GQM1875G2E3R9DB12#				±0.1pF	GQM1875G2E5R3BB12#
		4.0pF	±0.05pF	GQM1875G2E4R0WB12#				±0.25pF	GQM1875G2E5R3CB12#
			±0.1pF	GQM1875G2E4R0BB12#				±0.5pF	GQM1875G2E5R3DB12#
			±0.25pF	GQM1875G2E4R0CB12#			5.4pF	±0.05pF	GQM1875G2E5R4WB12#
			±0.5pF	GQM1875G2E4R0DB12#				±0.1pF	GQM1875G2E5R4BB12#
		4.1pF	±0.05pF	GQM1875G2E4R1WB12#				±0.25pF	GQM1875G2E5R4CB12#

- GRM
- GR3
- GRJ
- GR4
- GJM
- GQM**
- GA2
- GA3 GB
- GA3 GD
- GA3 GF
- LLL
- LLA
- LLM
- LLR
- NFM
- GJ4
- ZRA
- ZRB
- KRM
- KR3
- GMA
- GMD
- ⚠Caution /Notice

Part number # indicates the package specification code.

GQM Series Temperature Compensating Type High Q Part Number List

(→ 1.6×0.8mm)

Rated Voltage	TC Code	Cap.	Tol.	Part Number	Rated Voltage	TC Code	Cap.	Tol.	Part Number
250Vdc	X8G	5.4pF	±0.5pF	GQM1875G2E5R4DB12#	250Vdc	X8G	6.8pF	±0.1pF	GQM1875G2E6R8BB12#
			±0.05pF	GQM1875G2E5R5WB12#				±0.25pF	GQM1875G2E6R8CB12#
			±0.1pF	GQM1875G2E5R5BB12#				±0.5pF	GQM1875G2E6R8DB12#
			±0.25pF	GQM1875G2E5R5CB12#				6.9pF	±0.05pF
		±0.5pF	GQM1875G2E5R5DB12#	±0.1pF			GQM1875G2E6R9BB12#		
		5.6pF	±0.05pF	GQM1875G2E5R6WB12#			±0.25pF		GQM1875G2E6R9CB12#
			±0.1pF	GQM1875G2E5R6BB12#			±0.5pF		GQM1875G2E6R9DB12#
			±0.25pF	GQM1875G2E5R6CB12#			7.0pF	±0.05pF	GQM1875G2E7R0WB12#
			±0.5pF	GQM1875G2E5R6DB12#				±0.1pF	GQM1875G2E7R0BB12#
		5.7pF	±0.05pF	GQM1875G2E5R7WB12#				±0.25pF	GQM1875G2E7R0CB12#
			±0.1pF	GQM1875G2E5R7BB12#				±0.5pF	GQM1875G2E7R0DB12#
			±0.25pF	GQM1875G2E5R7CB12#			7.1pF	±0.05pF	GQM1875G2E7R1WB12#
			±0.5pF	GQM1875G2E5R7DB12#				±0.1pF	GQM1875G2E7R1BB12#
		5.8pF	±0.05pF	GQM1875G2E5R8WB12#				±0.25pF	GQM1875G2E7R1CB12#
			±0.1pF	GQM1875G2E5R8BB12#				±0.5pF	GQM1875G2E7R1DB12#
			±0.25pF	GQM1875G2E5R8CB12#			7.2pF	±0.05pF	GQM1875G2E7R2WB12#
			±0.5pF	GQM1875G2E5R8DB12#				±0.1pF	GQM1875G2E7R2BB12#
		5.9pF	±0.05pF	GQM1875G2E5R9WB12#				±0.25pF	GQM1875G2E7R2CB12#
			±0.1pF	GQM1875G2E5R9BB12#				±0.5pF	GQM1875G2E7R2DB12#
			±0.25pF	GQM1875G2E5R9CB12#			7.3pF	±0.05pF	GQM1875G2E7R3WB12#
			±0.5pF	GQM1875G2E5R9DB12#				±0.1pF	GQM1875G2E7R3BB12#
		6.0pF	±0.05pF	GQM1875G2E6R0WB12#				±0.25pF	GQM1875G2E7R3CB12#
			±0.1pF	GQM1875G2E6R0BB12#				±0.5pF	GQM1875G2E7R3DB12#
			±0.25pF	GQM1875G2E6R0CB12#			7.4pF	±0.05pF	GQM1875G2E7R4WB12#
			±0.5pF	GQM1875G2E6R0DB12#				±0.1pF	GQM1875G2E7R4BB12#
		6.1pF	±0.05pF	GQM1875G2E6R1WB12#				±0.25pF	GQM1875G2E7R4CB12#
			±0.1pF	GQM1875G2E6R1BB12#				±0.5pF	GQM1875G2E7R4DB12#
			±0.25pF	GQM1875G2E6R1CB12#			7.5pF	±0.05pF	GQM1875G2E7R5WB12#
			±0.5pF	GQM1875G2E6R1DB12#				±0.1pF	GQM1875G2E7R5BB12#
		6.2pF	±0.05pF	GQM1875G2E6R2WB12#				±0.25pF	GQM1875G2E7R5CB12#
			±0.1pF	GQM1875G2E6R2BB12#				±0.5pF	GQM1875G2E7R5DB12#
			±0.25pF	GQM1875G2E6R2CB12#			7.6pF	±0.05pF	GQM1875G2E7R6WB12#
			±0.5pF	GQM1875G2E6R2DB12#				±0.1pF	GQM1875G2E7R6BB12#
		6.3pF	±0.05pF	GQM1875G2E6R3WB12#				±0.25pF	GQM1875G2E7R6CB12#
			±0.1pF	GQM1875G2E6R3BB12#				±0.5pF	GQM1875G2E7R6DB12#
			±0.25pF	GQM1875G2E6R3CB12#			7.7pF	±0.05pF	GQM1875G2E7R7WB12#
			±0.5pF	GQM1875G2E6R3DB12#				±0.1pF	GQM1875G2E7R7BB12#
		6.4pF	±0.05pF	GQM1875G2E6R4WB12#				±0.25pF	GQM1875G2E7R7CB12#
			±0.1pF	GQM1875G2E6R4BB12#				±0.5pF	GQM1875G2E7R7DB12#
			±0.25pF	GQM1875G2E6R4CB12#			7.8pF	±0.05pF	GQM1875G2E7R8WB12#
			±0.5pF	GQM1875G2E6R4DB12#				±0.1pF	GQM1875G2E7R8BB12#
		6.5pF	±0.05pF	GQM1875G2E6R5WB12#				±0.25pF	GQM1875G2E7R8CB12#
			±0.1pF	GQM1875G2E6R5BB12#				±0.5pF	GQM1875G2E7R8DB12#
			±0.25pF	GQM1875G2E6R5CB12#			7.9pF	±0.05pF	GQM1875G2E7R9WB12#
			±0.5pF	GQM1875G2E6R5DB12#				±0.1pF	GQM1875G2E7R9BB12#
		6.6pF	±0.05pF	GQM1875G2E6R6WB12#				±0.25pF	GQM1875G2E7R9CB12#
			±0.1pF	GQM1875G2E6R6BB12#				±0.5pF	GQM1875G2E7R9DB12#
			±0.25pF	GQM1875G2E6R6CB12#			8.0pF	±0.05pF	GQM1875G2E8R0WB12#
			±0.5pF	GQM1875G2E6R6DB12#				±0.1pF	GQM1875G2E8R0BB12#
		6.7pF	±0.05pF	GQM1875G2E6R7WB12#				±0.25pF	GQM1875G2E8R0CB12#
			±0.1pF	GQM1875G2E6R7BB12#				±0.5pF	GQM1875G2E8R0DB12#
			±0.25pF	GQM1875G2E6R7CB12#			8.1pF	±0.05pF	GQM1875G2E8R1WB12#
			±0.5pF	GQM1875G2E6R7DB12#				±0.1pF	GQM1875G2E8R1BB12#
		6.8pF	±0.05pF	GQM1875G2E6R8WB12#				±0.25pF	GQM1875G2E8R1CB12#

- GRM
- GR3
- GRJ
- GR4
- GJM
- GQM**
- GA2
- GA3 GB
- GA3 GD
- GA3 GF
- LLL
- LLA
- LLM
- LLR
- NFM
- GJ4
- ZRA
- ZRB
- KRM
- KR3
- GMA
- GMD
- △Caution / Notice

Part number # indicates the package specification code.

GQM Series Temperature Compensating Type High Q Part Number List

(→ 1.6×0.8mm)

Rated Voltage	TC Code	Cap.	Tol.	Part Number	
250Vdc	X8G	8.1pF	±0.5pF	GQM1875G2E8R1DB12#	
			±0.05pF	GQM1875G2E8R2WB12#	
				±0.1pF	GQM1875G2E8R2BB12#
		±0.25pF		GQM1875G2E8R2CB12#	
		8.2pF	±0.5pF	GQM1875G2E8R2DB12#	
			±0.05pF	GQM1875G2E8R3WB12#	
				±0.1pF	GQM1875G2E8R3BB12#
				±0.25pF	GQM1875G2E8R3CB12#
		8.3pF	±0.5pF	GQM1875G2E8R3DB12#	
			±0.05pF	GQM1875G2E8R4WB12#	
				±0.1pF	GQM1875G2E8R4BB12#
		8.4pF		±0.25pF	GQM1875G2E8R4CB12#
			±0.5pF	GQM1875G2E8R4DB12#	
			±0.05pF	GQM1875G2E8R5WB12#	
				±0.1pF	GQM1875G2E8R5BB12#
		±0.25pF		GQM1875G2E8R5CB12#	
		8.5pF	±0.5pF	GQM1875G2E8R5DB12#	
			±0.05pF	GQM1875G2E8R6WB12#	
				±0.1pF	GQM1875G2E8R6BB12#
		8.6pF		±0.25pF	GQM1875G2E8R6CB12#
			±0.5pF	GQM1875G2E8R6DB12#	
			±0.05pF	GQM1875G2E8R7WB12#	
				±0.1pF	GQM1875G2E8R7BB12#
		±0.25pF		GQM1875G2E8R7CB12#	
		8.7pF	±0.5pF	GQM1875G2E8R7DB12#	
			±0.05pF	GQM1875G2E8R8WB12#	
				±0.1pF	GQM1875G2E8R8BB12#
				±0.25pF	GQM1875G2E8R8CB12#
		8.8pF	±0.5pF	GQM1875G2E8R8DB12#	
			±0.05pF	GQM1875G2E8R9WB12#	
				±0.1pF	GQM1875G2E8R9BB12#
				±0.25pF	GQM1875G2E8R9CB12#
		8.9pF	±0.5pF	GQM1875G2E8R9DB12#	
			±0.05pF	GQM1875G2E9R0WB12#	
				±0.1pF	GQM1875G2E9R0BB12#
				±0.25pF	GQM1875G2E9R0CB12#
		9.0pF	±0.5pF	GQM1875G2E9R0DB12#	
			±0.05pF	GQM1875G2E9R1WB12#	
				±0.1pF	GQM1875G2E9R1BB12#
				±0.25pF	GQM1875G2E9R1CB12#
		9.1pF	±0.5pF	GQM1875G2E9R1DB12#	
			±0.1pF	GQM1875G2E9R2BB12#	
				±0.25pF	GQM1875G2E9R2CB12#
		9.2pF		±0.5pF	GQM1875G2E9R2DB12#
			±0.1pF	GQM1875G2E9R3BB12#	
				±0.25pF	GQM1875G2E9R3CB12#
		9.3pF		±0.5pF	GQM1875G2E9R3DB12#
			±0.1pF	GQM1875G2E9R4BB12#	
				±0.25pF	GQM1875G2E9R4CB12#
		9.4pF		±0.5pF	GQM1875G2E9R4DB12#
			±0.1pF	GQM1875G2E9R5BB12#	
				±0.25pF	GQM1875G2E9R5CB12#
		9.5pF		±0.5pF	GQM1875G2E9R5DB12#
			±0.1pF	GQM1875G2E9R6BB12#	

Rated Voltage	TC Code	Cap.	Tol.	Part Number
250Vdc	X8G	9.6pF	±0.25pF	GQM1875G2E9R6CB12#
			±0.5pF	GQM1875G2E9R6DB12#
		9.7pF	±0.1pF	GQM1875G2E9R7BB12#
			±0.25pF	GQM1875G2E9R7CB12#
			±0.5pF	GQM1875G2E9R7DB12#
		9.8pF	±0.1pF	GQM1875G2E9R8BB12#
			±0.25pF	GQM1875G2E9R8CB12#
			±0.5pF	GQM1875G2E9R8DB12#
		9.9pF	±0.1pF	GQM1875G2E9R9BB12#
			±0.25pF	GQM1875G2E9R9CB12#
			±0.5pF	GQM1875G2E9R9DB12#
		10pF	±1%	GQM1875G2E100FB12#
			±2%	GQM1875G2E100GB12#
			±2.5%	GQM1875G2E100RB12#
			±5%	GQM1875G2E100JB12#
		11pF	±1%	GQM1875G2E110FB12#
			±2%	GQM1875G2E110GB12#
			±5%	GQM1875G2E110JB12#
		12pF	±1%	GQM1875G2E120FB12#
			±2%	GQM1875G2E120GB12#
			±5%	GQM1875G2E120JB12#
		13pF	±1%	GQM1875G2E130FB12#
			±2%	GQM1875G2E130GB12#
			±5%	GQM1875G2E130JB12#
		15pF	±1%	GQM1875G2E150FB12#
			±2%	GQM1875G2E150GB12#
			±5%	GQM1875G2E150JB12#
		16pF	±1%	GQM1875G2E160FB12#
			±2%	GQM1875G2E160GB12#
			±5%	GQM1875G2E160JB12#
		18pF	±1%	GQM1875G2E180FB12#
			±2%	GQM1875G2E180GB12#
			±5%	GQM1875G2E180JB12#
		20pF	±1%	GQM1875G2E200FB12#
			±2%	GQM1875G2E200GB12#
			±5%	GQM1875G2E200JB12#
		22pF	±1%	GQM1875G2E220FB12#
			±2%	GQM1875G2E220GB12#
			±5%	GQM1875G2E220JB12#
		24pF	±1%	GQM1875G2E240FB12#
			±2%	GQM1875G2E240GB12#
			±5%	GQM1875G2E240JB12#
27pF	±1%	GQM1875G2E270FB12#		
	±2%	GQM1875G2E270GB12#		
	±5%	GQM1875G2E270JB12#		
30pF	±1%	GQM1875G2E300FB12#		
	±2%	GQM1875G2E300GB12#		
	±5%	GQM1875G2E300JB12#		

2.0×1.25mm

Rated Voltage	TC Code	Cap.	Tol.	Part Number
500Vdc	X8G	0.20pF	±0.05pF	GQM2195G2HR20WB12#

Part number # indicates the package specification code.

- GRM
- GR3
- GRJ
- GR4
- GJM
- GQM**
- GA2
- GA3 GB
- GA3 GD
- GA3 GF
- LLL
- LLA
- LLM
- LLR
- NFM
- GJ4
- ZRA
- ZRB
- KRM
- KR3
- GMA
- GMD
- △Caution /Notice

GQM Series Temperature Compensating Type High Q Part Number List

(→ 2.0×1.25mm)

Rated Voltage	TC Code	Cap.	Tol.	Part Number	Rated Voltage	TC Code	Cap.	Tol.	Part Number		
500Vdc	X8G	0.20pF	±0.1pF	GQM2195G2HR20BB12#	500Vdc	X8G	1.5pF	±0.5pF	GQM2195G2H1R5DB12#		
			±0.05pF	GQM2195G2HR30WB12#				1.6pF	±0.05pF	GQM2195G2H1R6WB12#	
				±0.1pF					GQM2195G2HR30BB12#	±0.1pF	GQM2195G2H1R6BB12#
		±0.25pF		GQM2195G2HR30CB12#			±0.25pF		GQM2195G2H1R6CB12#		
		0.40pF	±0.05pF	GQM2195G2HR40WB12#			±0.5pF	GQM2195G2H1R6DB12#	1.7pF	±0.05pF	GQM2195G2H1R7WB12#
			±0.1pF	GQM2195G2HR40BB12#				±0.1pF		GQM2195G2H1R7BB12#	
			±0.25pF	GQM2195G2HR40CB12#				±0.25pF		GQM2195G2H1R7CB12#	
		0.50pF	±0.05pF	GQM2195G2HR50WB12#			±0.5pF	GQM2195G2H1R7DB12#	1.8pF	±0.05pF	GQM2195G2H1R8WB12#
			±0.1pF	GQM2195G2HR50BB12#				±0.1pF		GQM2195G2H1R8BB12#	
			±0.25pF	GQM2195G2HR50CB12#				±0.25pF		GQM2195G2H1R8CB12#	
			±0.5pF	GQM2195G2HR50DB12#				±0.5pF		GQM2195G2H1R8DB12#	
		0.60pF	±0.05pF	GQM2195G2HR60WB12#			±0.5pF	GQM2195G2H1R8DB12#	1.9pF	±0.05pF	GQM2195G2H1R9WB12#
			±0.1pF	GQM2195G2HR60BB12#				±0.1pF		GQM2195G2H1R9BB12#	
			±0.25pF	GQM2195G2HR60CB12#				±0.25pF		GQM2195G2H1R9CB12#	
			±0.5pF	GQM2195G2HR60DB12#				±0.5pF		GQM2195G2H1R9DB12#	
		0.70pF	±0.05pF	GQM2195G2HR70WB12#			±0.5pF	GQM2195G2H1R9DB12#	2.0pF	±0.05pF	GQM2195G2H2R0WB12#
			±0.1pF	GQM2195G2HR70BB12#				±0.1pF		GQM2195G2H2R0BB12#	
			±0.25pF	GQM2195G2HR70CB12#				±0.25pF		GQM2195G2H2R0CB12#	
			±0.5pF	GQM2195G2HR70DB12#				±0.5pF		GQM2195G2H2R0DB12#	
		0.75pF	±0.05pF	GQM2195G2HR75WB12#			±0.5pF	GQM2195G2H2R0DB12#	2.1pF	±0.05pF	GQM2195G2H2R1WB12#
			±0.1pF	GQM2195G2HR75BB12#				±0.1pF		GQM2195G2H2R1BB12#	
			±0.25pF	GQM2195G2HR75CB12#				±0.25pF		GQM2195G2H2R1CB12#	
			±0.5pF	GQM2195G2HR75DB12#				±0.5pF		GQM2195G2H2R1DB12#	
		0.80pF	±0.05pF	GQM2195G2HR80WB12#			±0.5pF	GQM2195G2H2R1DB12#	2.2pF	±0.05pF	GQM2195G2H2R2WB12#
			±0.1pF	GQM2195G2HR80BB12#				±0.1pF		GQM2195G2H2R2BB12#	
			±0.25pF	GQM2195G2HR80CB12#				±0.25pF		GQM2195G2H2R2CB12#	
			±0.5pF	GQM2195G2HR80DB12#				±0.5pF		GQM2195G2H2R2DB12#	
		0.90pF	±0.05pF	GQM2195G2HR90WB12#			±0.5pF	GQM2195G2H2R2DB12#	2.3pF	±0.05pF	GQM2195G2H2R3WB12#
			±0.1pF	GQM2195G2HR90BB12#				±0.1pF		GQM2195G2H2R3BB12#	
			±0.25pF	GQM2195G2HR90CB12#				±0.25pF		GQM2195G2H2R3CB12#	
			±0.5pF	GQM2195G2HR90DB12#				±0.5pF		GQM2195G2H2R3DB12#	
		1.0pF	±0.05pF	GQM2195G2H1R0WB12#			±0.5pF	GQM2195G2H2R3DB12#	2.4pF	±0.05pF	GQM2195G2H2R4WB12#
			±0.1pF	GQM2195G2H1R0BB12#				±0.1pF		GQM2195G2H2R4BB12#	
			±0.25pF	GQM2195G2H1R0CB12#				±0.25pF		GQM2195G2H2R4CB12#	
			±0.5pF	GQM2195G2H1R0DB12#				±0.5pF		GQM2195G2H2R4DB12#	
		1.1pF	±0.05pF	GQM2195G2H1R1WB12#			±0.5pF	GQM2195G2H2R4DB12#	2.5pF	±0.05pF	GQM2195G2H2R5WB12#
			±0.1pF	GQM2195G2H1R1BB12#				±0.1pF		GQM2195G2H2R5BB12#	
			±0.25pF	GQM2195G2H1R1CB12#				±0.25pF		GQM2195G2H2R5CB12#	
			±0.5pF	GQM2195G2H1R1DB12#				±0.5pF		GQM2195G2H2R5DB12#	
		1.2pF	±0.05pF	GQM2195G2H1R2WB12#			±0.5pF	GQM2195G2H2R5DB12#	2.6pF	±0.05pF	GQM2195G2H2R6WB12#
			±0.1pF	GQM2195G2H1R2BB12#				±0.1pF		GQM2195G2H2R6BB12#	
			±0.25pF	GQM2195G2H1R2CB12#				±0.25pF		GQM2195G2H2R6CB12#	
			±0.5pF	GQM2195G2H1R2DB12#				±0.5pF		GQM2195G2H2R6DB12#	
		1.3pF	±0.05pF	GQM2195G2H1R3WB12#			±0.5pF	GQM2195G2H2R6DB12#	2.7pF	±0.05pF	GQM2195G2H2R7WB12#
			±0.1pF	GQM2195G2H1R3BB12#				±0.1pF		GQM2195G2H2R7BB12#	
			±0.25pF	GQM2195G2H1R3CB12#				±0.25pF		GQM2195G2H2R7CB12#	
			±0.5pF	GQM2195G2H1R3DB12#				±0.5pF		GQM2195G2H2R7DB12#	
		1.4pF	±0.05pF	GQM2195G2H1R4WB12#			±0.5pF	GQM2195G2H2R7DB12#	2.8pF	±0.05pF	GQM2195G2H2R8WB12#
			±0.1pF	GQM2195G2H1R4BB12#				±0.1pF		GQM2195G2H2R8BB12#	
			±0.25pF	GQM2195G2H1R4CB12#				±0.25pF		GQM2195G2H2R8CB12#	
			±0.5pF	GQM2195G2H1R4DB12#				±0.5pF		GQM2195G2H2R8DB12#	
		1.5pF	±0.05pF	GQM2195G2H1R5WB12#			±0.5pF	GQM2195G2H2R8DB12#	2.9pF	±0.05pF	GQM2195G2H2R9WB12#
			±0.1pF	GQM2195G2H1R5BB12#							
			±0.25pF	GQM2195G2H1R5CB12#							

Part number # indicates the package specification code.

- GRM
- GR3
- GRJ
- GR4
- GJM
- GQM**
- GA2
- GA3 GB
- GA3 GD
- GA3 GF
- LLL
- LLA
- LLM
- LLR
- NFM
- GJ4
- ZRA
- ZRB
- KRM
- KR3
- GMA
- GMD
- ⚠Caution /Notice

GQM Series Temperature Compensating Type High Q Part Number List

(→ 2.0×1.25mm)

Rated Voltage	TC Code	Cap.	Tol.	Part Number	Rated Voltage	TC Code	Cap.	Tol.	Part Number		
500Vdc	X8G	2.9pF	±0.1pF	GQM2195G2H2R9BB12#	500Vdc	X8G	4.2pF	±0.5pF	GQM2195G2H4R2DB12#		
			±0.25pF	GQM2195G2H2R9CB12#				4.3pF	±0.05pF	GQM2195G2H4R3WB12#	
			±0.5pF	GQM2195G2H2R9DB12#					±0.1pF	GQM2195G2H4R3BB12#	
		±0.05pF	GQM2195G2H3R0WB12#	±0.25pF			GQM2195G2H4R3CB12#				
		±0.1pF	GQM2195G2H3R0BB12#	±0.5pF			GQM2195G2H4R3DB12#	4.4pF	±0.05pF	GQM2195G2H4R4WB12#	
		±0.25pF	GQM2195G2H3R0CB12#	±0.1pF			GQM2195G2H4R4BB12#		±0.25pF	GQM2195G2H4R4CB12#	
		±0.5pF	GQM2195G2H3R0DB12#	±0.5pF			GQM2195G2H4R4DB12#		4.5pF	±0.05pF	GQM2195G2H4R5WB12#
		±0.05pF	GQM2195G2H3R1WB12#	±0.1pF			GQM2195G2H4R5BB12#	±0.25pF		GQM2195G2H4R5CB12#	
		±0.1pF	GQM2195G2H3R1BB12#	±0.5pF			GQM2195G2H4R5DB12#	4.6pF		±0.05pF	GQM2195G2H4R6WB12#
		±0.25pF	GQM2195G2H3R1CB12#	±0.1pF			GQM2195G2H4R6BB12#		±0.25pF	GQM2195G2H4R6CB12#	
		±0.5pF	GQM2195G2H3R1DB12#	±0.5pF			GQM2195G2H4R6DB12#		4.7pF	±0.05pF	GQM2195G2H4R7WB12#
		±0.05pF	GQM2195G2H3R2WB12#	±0.1pF			GQM2195G2H4R7BB12#	±0.25pF		GQM2195G2H4R7CB12#	
		±0.1pF	GQM2195G2H3R2BB12#	±0.5pF			GQM2195G2H4R7DB12#	4.8pF		±0.05pF	GQM2195G2H4R8WB12#
		±0.25pF	GQM2195G2H3R2CB12#	±0.1pF			GQM2195G2H4R8BB12#		±0.25pF	GQM2195G2H4R8CB12#	
		±0.5pF	GQM2195G2H3R2DB12#	±0.5pF			GQM2195G2H4R8DB12#		4.9pF	±0.05pF	GQM2195G2H4R9WB12#
		±0.05pF	GQM2195G2H3R3WB12#	±0.1pF			GQM2195G2H4R9BB12#	±0.25pF		GQM2195G2H4R9CB12#	
		±0.1pF	GQM2195G2H3R3BB12#	±0.5pF			GQM2195G2H4R9DB12#	5.0pF		±0.05pF	GQM2195G2H5R0WB12#
		±0.25pF	GQM2195G2H3R3CB12#	±0.1pF			GQM2195G2H5R0BB12#		±0.25pF	GQM2195G2H5R0CB12#	
		±0.5pF	GQM2195G2H3R3DB12#	±0.5pF			GQM2195G2H5R0DB12#		5.1pF	±0.05pF	GQM2195G2H5R1WB12#
		±0.05pF	GQM2195G2H3R4WB12#	±0.1pF			GQM2195G2H5R1BB12#	±0.25pF		GQM2195G2H5R1CB12#	
		±0.1pF	GQM2195G2H3R4BB12#	±0.5pF			GQM2195G2H5R1DB12#	5.2pF		±0.05pF	GQM2195G2H5R2WB12#
		±0.25pF	GQM2195G2H3R4CB12#	±0.1pF			GQM2195G2H5R2BB12#		±0.25pF	GQM2195G2H5R2CB12#	
		±0.5pF	GQM2195G2H3R4DB12#	±0.5pF			GQM2195G2H5R2DB12#		5.3pF	±0.05pF	GQM2195G2H5R3WB12#
		±0.05pF	GQM2195G2H3R5WB12#	±0.1pF			GQM2195G2H5R3BB12#	±0.25pF		GQM2195G2H5R3CB12#	
		±0.1pF	GQM2195G2H3R5BB12#	±0.5pF			GQM2195G2H5R3DB12#	5.4pF		±0.05pF	GQM2195G2H5R4WB12#
		±0.25pF	GQM2195G2H3R5CB12#	±0.1pF			GQM2195G2H5R4BB12#		±0.25pF	GQM2195G2H5R4CB12#	
		±0.5pF	GQM2195G2H3R5DB12#	±0.5pF			GQM2195G2H5R4DB12#		5.5pF	±0.05pF	GQM2195G2H5R5WB12#
		±0.05pF	GQM2195G2H3R6WB12#	±0.1pF			GQM2195G2H5R5BB12#	±0.25pF		GQM2195G2H5R5CB12#	
		±0.1pF	GQM2195G2H3R6BB12#	±0.5pF			GQM2195G2H5R5DB12#	5.6pF		±0.05pF	GQM2195G2H5R6WB12#
		±0.25pF	GQM2195G2H3R6CB12#	±0.1pF			GQM2195G2H4R2BB12#				
		±0.5pF	GQM2195G2H3R6DB12#	±0.25pF			GQM2195G2H4R2CB12#				
		±0.05pF	GQM2195G2H3R7WB12#								
		±0.1pF	GQM2195G2H3R7BB12#								
		±0.25pF	GQM2195G2H3R7CB12#								
		±0.5pF	GQM2195G2H3R7DB12#								
		±0.05pF	GQM2195G2H3R8WB12#								
		±0.1pF	GQM2195G2H3R8BB12#								
		±0.25pF	GQM2195G2H3R8CB12#								
		±0.5pF	GQM2195G2H3R8DB12#								
		±0.05pF	GQM2195G2H3R9WB12#								
		±0.1pF	GQM2195G2H3R9BB12#								
		±0.25pF	GQM2195G2H3R9CB12#								
		±0.5pF	GQM2195G2H3R9DB12#								
		±0.05pF	GQM2195G2H4R0WB12#								
		±0.1pF	GQM2195G2H4R0BB12#								
		±0.25pF	GQM2195G2H4R0CB12#								
		±0.5pF	GQM2195G2H4R0DB12#								
		±0.05pF	GQM2195G2H4R1WB12#								
		±0.1pF	GQM2195G2H4R1BB12#								
		±0.25pF	GQM2195G2H4R1CB12#								
		±0.5pF	GQM2195G2H4R1DB12#								
		±0.05pF	GQM2195G2H4R2WB12#								
		±0.1pF	GQM2195G2H4R2BB12#								
		±0.25pF	GQM2195G2H4R2CB12#								

- GRM
- GR3
- GRJ
- GR4
- GJM
- GQM**
- GA2
- GA3 GB
- GA3 GD
- GA3 GF
- LLL
- LLA
- LLM
- LLR
- NFM
- GJ4
- ZRA
- ZRB
- KRM
- KR3
- GMA
- GMD
- ⚠Caution /Notice

Part number # indicates the package specification code.

GQM Series Temperature Compensating Type High Q Part Number List

(→ 2.0×1.25mm)

Rated Voltage	TC Code	Cap.	Tol.	Part Number	Rated Voltage	TC Code	Cap.	Tol.	Part Number				
500Vdc	X8G	5.6pF	±0.1pF	GQM2195G2H5R6BB12#	500Vdc	X8G	7.0pF	±0.1pF	GQM2195G2H7R0BB12#				
			±0.25pF	GQM2195G2H5R6CB12#				±0.25pF	GQM2195G2H7R0CB12#				
			±0.5pF	GQM2195G2H5R6DB12#				±0.5pF	GQM2195G2H7R0DB12#				
		5.7pF	±0.05pF	GQM2195G2H5R7WB12#			7.1pF	±0.1pF	GQM2195G2H7R1BB12#				
			±0.1pF	GQM2195G2H5R7BB12#				±0.25pF	GQM2195G2H7R1CB12#				
			±0.25pF	GQM2195G2H5R7CB12#				±0.5pF	GQM2195G2H7R1DB12#				
		5.8pF	±0.05pF	GQM2195G2H5R8WB12#			7.2pF	±0.1pF	GQM2195G2H7R2BB12#				
			±0.1pF	GQM2195G2H5R8BB12#				±0.25pF	GQM2195G2H7R2CB12#				
			±0.25pF	GQM2195G2H5R8CB12#				±0.5pF	GQM2195G2H7R2DB12#				
		5.9pF	±0.05pF	GQM2195G2H5R9WB12#			7.3pF	±0.1pF	GQM2195G2H7R3BB12#				
			±0.1pF	GQM2195G2H5R9BB12#				±0.25pF	GQM2195G2H7R3CB12#				
			±0.25pF	GQM2195G2H5R9CB12#				±0.5pF	GQM2195G2H7R3DB12#				
		6.0pF	±0.05pF	GQM2195G2H6R0WB12#			7.4pF	±0.1pF	GQM2195G2H7R4BB12#				
			±0.1pF	GQM2195G2H6R0BB12#				±0.25pF	GQM2195G2H7R4CB12#				
			±0.25pF	GQM2195G2H6R0CB12#				±0.5pF	GQM2195G2H7R4DB12#				
		6.1pF	±0.05pF	GQM2195G2H6R1WB12#			7.5pF	±0.1pF	GQM2195G2H7R5BB12#				
			±0.1pF	GQM2195G2H6R1BB12#				±0.25pF	GQM2195G2H7R5CB12#				
			±0.25pF	GQM2195G2H6R1CB12#				±0.5pF	GQM2195G2H7R5DB12#				
		6.2pF	±0.05pF	GQM2195G2H6R2WB12#			7.6pF	±0.1pF	GQM2195G2H7R6BB12#				
			±0.1pF	GQM2195G2H6R2BB12#				±0.25pF	GQM2195G2H7R6CB12#				
			±0.25pF	GQM2195G2H6R2CB12#				±0.5pF	GQM2195G2H7R6DB12#				
		6.3pF	±0.05pF	GQM2195G2H6R3WB12#			7.7pF	±0.1pF	GQM2195G2H7R7BB12#				
			±0.1pF	GQM2195G2H6R3BB12#				±0.25pF	GQM2195G2H7R7CB12#				
			±0.25pF	GQM2195G2H6R3CB12#				±0.5pF	GQM2195G2H7R7DB12#				
		6.4pF	±0.05pF	GQM2195G2H6R4WB12#			7.8pF	±0.1pF	GQM2195G2H7R8BB12#				
			±0.1pF	GQM2195G2H6R4BB12#				±0.25pF	GQM2195G2H7R8CB12#				
			±0.25pF	GQM2195G2H6R4CB12#				±0.5pF	GQM2195G2H7R8DB12#				
		6.5pF	±0.05pF	GQM2195G2H6R5WB12#			7.9pF	±0.1pF	GQM2195G2H7R9BB12#				
			±0.1pF	GQM2195G2H6R5BB12#				±0.25pF	GQM2195G2H7R9CB12#				
			±0.25pF	GQM2195G2H6R5CB12#				±0.5pF	GQM2195G2H7R9DB12#				
		6.6pF	±0.05pF	GQM2195G2H6R6WB12#			8.0pF	±0.1pF	GQM2195G2H8R0BB12#				
			±0.1pF	GQM2195G2H6R6BB12#				±0.25pF	GQM2195G2H8R0CB12#				
			±0.25pF	GQM2195G2H6R6CB12#				±0.5pF	GQM2195G2H8R0DB12#				
		6.7pF	±0.05pF	GQM2195G2H6R7WB12#			8.1pF	±0.1pF	GQM2195G2H8R1BB12#				
			±0.1pF	GQM2195G2H6R7BB12#				±0.25pF	GQM2195G2H8R1CB12#				
			±0.25pF	GQM2195G2H6R7CB12#				±0.5pF	GQM2195G2H8R1DB12#				
		6.8pF	±0.05pF	GQM2195G2H6R8WB12#			8.2pF	±0.1pF	GQM2195G2H8R2BB12#				
			±0.1pF	GQM2195G2H6R8BB12#				±0.25pF	GQM2195G2H8R2CB12#				
			±0.25pF	GQM2195G2H6R8CB12#				±0.5pF	GQM2195G2H8R2DB12#				
		6.9pF	±0.05pF	GQM2195G2H6R9WB12#			8.3pF	±0.1pF	GQM2195G2H8R3BB12#				
			±0.1pF	GQM2195G2H6R9BB12#				±0.25pF	GQM2195G2H8R3CB12#				
			±0.25pF	GQM2195G2H6R9CB12#				±0.5pF	GQM2195G2H8R3DB12#				
									8.4pF	±0.1pF	GQM2195G2H8R4BB12#		
										±0.25pF	GQM2195G2H8R4CB12#		
										±0.5pF	GQM2195G2H8R4DB12#		
									8.5pF	±0.1pF	GQM2195G2H8R5BB12#		
										±0.25pF	GQM2195G2H8R5CB12#		
										±0.5pF	GQM2195G2H8R5DB12#		
									8.6pF	±0.1pF	GQM2195G2H8R6BB12#		
										±0.25pF	GQM2195G2H8R6CB12#		
										±0.5pF	GQM2195G2H8R6DB12#		
									8.7pF	±0.1pF	GQM2195G2H8R7BB12#		
										±0.25pF	GQM2195G2H8R7CB12#		
										±0.5pF	GQM2195G2H8R7DB12#		

Part number # indicates the package specification code.

- GRM
- GR3
- GRJ
- GR4
- GJM
- GQM**
- GA2
- GA3 GB
- GA3 GD
- GA3 GF
- LLL
- LLA
- LLM
- LLR
- NFM
- GJ4
- ZRA
- ZRB
- KRM
- KR3
- GMA
- GMD
- ⚠Caution /Notice

GQM Series Temperature Compensating Type High Q Part Number List

(→ 2.0×1.25mm)

Rated Voltage	TC Code	Cap.	Tol.	Part Number		Rated Voltage	TC Code	Cap.	Tol.	Part Number			
500Vdc	X8G	8.8pF	±0.1pF	GQM2195G2H8R8BB12#		500Vdc	X8G	15pF	±5%	GQM2195G2H150JB12#			
			±0.25pF	GQM2195G2H8R8CB12#				16pF	±1%	GQM2195G2H160FB12#			
			±0.5pF	GQM2195G2H8R8DB12#					±2%	GQM2195G2H160GB12#			
		8.9pF						±5%	GQM2195G2H160JB12#				
			±0.1pF	GQM2195G2H8R9BB12#				18pF	±1%	GQM2195G2H180FB12#			
			±0.25pF	GQM2195G2H8R9CB12#					±2%	GQM2195G2H180GB12#			
		±0.5pF	GQM2195G2H8R9DB12#		±5%				GQM2195G2H180JB12#				
		9.0pF	±0.1pF	GQM2195G2H9R0BB12#				20pF	±1%	GQM2195G2H200FB12#			
			±0.25pF	GQM2195G2H9R0CB12#					±2%	GQM2195G2H200GB12#			
			±0.5pF	GQM2195G2H9R0DB12#					±5%	GQM2195G2H200JB12#			
		9.1pF	±0.1pF	GQM2195G2H9R1BB12#				22pF	±1%	GQM2195G2H220FB12#			
			±0.25pF	GQM2195G2H9R1CB12#					±2%	GQM2195G2H220GB12#			
			±0.5pF	GQM2195G2H9R1DB12#					±5%	GQM2195G2H220JB12#			
		9.2pF	±0.1pF	GQM2195G2H9R2BB12#				250Vdc	COG	0.20pF	±0.05pF	GQM2195C2ER20WB12#	
			±0.25pF	GQM2195G2H9R2CB12#							±0.1pF	GQM2195C2ER20BB12#	
			±0.5pF	GQM2195G2H9R2DB12#						0.30pF	±0.05pF	GQM2195C2ER30WB12#	
		9.3pF	±0.1pF	GQM2195G2H9R3BB12#							±0.1pF	GQM2195C2ER30BB12#	
			±0.25pF	GQM2195G2H9R3CB12#							±0.25pF	GQM2195C2ER30CB12#	
			±0.5pF	GQM2195G2H9R3DB12#		0.40pF	±0.05pF			GQM2195C2ER40WB12#			
		9.4pF	±0.1pF	GQM2195G2H9R4BB12#			±0.1pF			GQM2195C2ER40BB12#			
			±0.25pF	GQM2195G2H9R4CB12#			±0.25pF			GQM2195C2ER40CB12#			
			±0.5pF	GQM2195G2H9R4DB12#		0.50pF	±0.05pF			GQM2195C2ER50WB12#			
		9.5pF	±0.1pF	GQM2195G2H9R5BB12#			±0.1pF			GQM2195C2ER50BB12#			
			±0.25pF	GQM2195G2H9R5CB12#			±0.25pF			GQM2195C2ER50CB12#			
			±0.5pF	GQM2195G2H9R5DB12#		±0.5pF	GQM2195C2ER50DB12#						
		9.6pF	±0.1pF	GQM2195G2H9R6BB12#		0.60pF	±0.05pF			GQM2195C2ER60WB12#			
			±0.25pF	GQM2195G2H9R6CB12#			±0.1pF			GQM2195C2ER60BB12#			
			±0.5pF	GQM2195G2H9R6DB12#			±0.25pF			GQM2195C2ER60CB12#			
		9.7pF	±0.1pF	GQM2195G2H9R7BB12#		±0.5pF	GQM2195C2ER60DB12#						
			±0.25pF	GQM2195G2H9R7CB12#		0.70pF	±0.05pF			GQM2195C2ER70WB12#			
			±0.5pF	GQM2195G2H9R7DB12#			±0.1pF			GQM2195C2ER70BB12#			
		9.8pF	±0.1pF	GQM2195G2H9R8BB12#			±0.25pF	GQM2195C2ER70CB12#					
			±0.25pF	GQM2195G2H9R8CB12#		±0.5pF	GQM2195C2ER70DB12#						
			±0.5pF	GQM2195G2H9R8DB12#		0.75pF	±0.05pF	GQM2195C2ER75WB12#					
		9.9pF	±0.1pF	GQM2195G2H9R9BB12#			±0.1pF	GQM2195C2ER75BB12#					
			±0.25pF	GQM2195G2H9R9CB12#			±0.25pF	GQM2195C2ER75CB12#					
			±0.5pF	GQM2195G2H9R9DB12#		±0.5pF	GQM2195C2ER75DB12#						
		10pF	±1%	GQM2195G2H100FB12#		0.80pF	±0.05pF	GQM2195C2ER80WB12#					
			±2%	GQM2195G2H100GB12#			±0.1pF	GQM2195C2ER80BB12#					
			±2.5%	GQM2195G2H100RB12#			±0.25pF	GQM2195C2ER80CB12#					
			±5%	GQM2195G2H100JB12#			±0.5pF	GQM2195C2ER80DB12#					
		11pF	±1%	GQM2195G2H110FB12#		0.90pF	±0.05pF	GQM2195C2ER90WB12#					
			±2%	GQM2195G2H110GB12#			±0.1pF	GQM2195C2ER90BB12#					
			±5%	GQM2195G2H110JB12#			±0.25pF	GQM2195C2ER90CB12#					
		12pF	±1%	GQM2195G2H120FB12#		±0.5pF	GQM2195C2ER90DB12#						
			±2%	GQM2195G2H120GB12#		1.0pF	±0.05pF	GQM2195C2E1R0WB12#					
			±5%	GQM2195G2H120JB12#			±0.1pF	GQM2195C2E1R0BB12#					
		13pF	±1%	GQM2195G2H130FB12#			±0.25pF	GQM2195C2E1R0CB12#					
			±2%	GQM2195G2H130GB12#		±0.5pF	GQM2195C2E1R0DB12#						
			±5%	GQM2195G2H130JB12#		1.1pF	±0.05pF	GQM2195C2E1R1WB12#					
		14pF	±1%	GQM2195G2H140FB12#			±0.1pF	GQM2195C2E1R1BB12#					
			±2%	GQM2195G2H140GB12#			±0.25pF	GQM2195C2E1R1CB12#					
			±5%	GQM2195G2H140JB12#		±0.5pF	GQM2195C2E1R1DB12#						
		15pF	±1%	GQM2195G2H150FB12#		1.2pF	±0.05pF	GQM2195C2E1R2WB12#					
±2%	GQM2195G2H150GB12#												

- GRM
- GR3
- GRJ
- GR4
- GJM
- GQM**
- GA2
- GA3 GB
- GA3 GD
- GA3 GF
- LLL
- LLA
- LLM
- LLR
- NFM
- GJ4
- ZRA
- ZRB
- KRM
- KR3
- GMA
- GMD
- ⚠Caution /Notice

Part number # indicates the package specification code.

GQM Series Temperature Compensating Type High Q Part Number List

(→ 2.0×1.25mm)

Rated Voltage	TC Code	Cap.	Tol.	Part Number	Rated Voltage	TC Code	Cap.	Tol.	Part Number	
250Vdc	COG	1.2pF	±0.1pF	GQM2195C2E1R2BB12#	250Vdc	COG	2.5pF	±0.5pF	GQM2195C2E2R5DB12#	
			±0.25pF	GQM2195C2E1R2CB12#				2.6pF	±0.05pF	GQM2195C2E2R6WB12#
			±0.5pF	GQM2195C2E1R2DB12#					±0.1pF	GQM2195C2E2R6BB12#
		1.3pF	±0.05pF	GQM2195C2E1R3WB12#			±0.25pF		GQM2195C2E2R6CB12#	
			±0.1pF	GQM2195C2E1R3BB12#			±0.5pF	GQM2195C2E2R6DB12#		
			±0.25pF	GQM2195C2E1R3CB12#			2.7pF	±0.05pF	GQM2195C2E2R7WB12#	
		±0.5pF	GQM2195C2E1R3DB12#	±0.1pF				GQM2195C2E2R7BB12#		
		1.4pF	±0.05pF	GQM2195C2E1R4WB12#				±0.25pF	GQM2195C2E2R7CB12#	
			±0.1pF	GQM2195C2E1R4BB12#			±0.5pF	GQM2195C2E2R7DB12#		
			±0.25pF	GQM2195C2E1R4CB12#			2.8pF	±0.05pF	GQM2195C2E2R8WB12#	
		±0.5pF	GQM2195C2E1R4DB12#	±0.1pF				GQM2195C2E2R8BB12#		
		1.5pF	±0.05pF	GQM2195C2E1R5WB12#				±0.25pF	GQM2195C2E2R8CB12#	
			±0.1pF	GQM2195C2E1R5BB12#			±0.5pF	GQM2195C2E2R8DB12#		
			±0.25pF	GQM2195C2E1R5CB12#			2.9pF	±0.05pF	GQM2195C2E2R9WB12#	
		±0.5pF	GQM2195C2E1R5DB12#	±0.1pF				GQM2195C2E2R9BB12#		
		1.6pF	±0.05pF	GQM2195C2E1R6WB12#				±0.25pF	GQM2195C2E2R9CB12#	
			±0.1pF	GQM2195C2E1R6BB12#			±0.5pF	GQM2195C2E2R9DB12#		
			±0.25pF	GQM2195C2E1R6CB12#			3.0pF	±0.05pF	GQM2195C2E3R0WB12#	
		±0.5pF	GQM2195C2E1R6DB12#	±0.1pF				GQM2195C2E3R0BB12#		
		1.7pF	±0.05pF	GQM2195C2E1R7WB12#				±0.25pF	GQM2195C2E3R0CB12#	
			±0.1pF	GQM2195C2E1R7BB12#			±0.5pF	GQM2195C2E3R0DB12#		
			±0.25pF	GQM2195C2E1R7CB12#			3.1pF	±0.05pF	GQM2195C2E3R1WB12#	
		±0.5pF	GQM2195C2E1R7DB12#	±0.1pF				GQM2195C2E3R1BB12#		
		1.8pF	±0.05pF	GQM2195C2E1R8WB12#				±0.25pF	GQM2195C2E3R1CB12#	
			±0.1pF	GQM2195C2E1R8BB12#			±0.5pF	GQM2195C2E3R1DB12#		
			±0.25pF	GQM2195C2E1R8CB12#			3.2pF	±0.05pF	GQM2195C2E3R2WB12#	
		±0.5pF	GQM2195C2E1R8DB12#	±0.1pF				GQM2195C2E3R2BB12#		
		1.9pF	±0.05pF	GQM2195C2E1R9WB12#				±0.25pF	GQM2195C2E3R2CB12#	
			±0.1pF	GQM2195C2E1R9BB12#			±0.5pF	GQM2195C2E3R2DB12#		
			±0.25pF	GQM2195C2E1R9CB12#			3.3pF	±0.05pF	GQM2195C2E3R3WB12#	
		±0.5pF	GQM2195C2E1R9DB12#	±0.1pF				GQM2195C2E3R3BB12#		
		2.0pF	±0.05pF	GQM2195C2E2R0WB12#				±0.25pF	GQM2195C2E3R3CB12#	
			±0.1pF	GQM2195C2E2R0BB12#			±0.5pF	GQM2195C2E3R3DB12#		
			±0.25pF	GQM2195C2E2R0CB12#			3.4pF	±0.05pF	GQM2195C2E3R4WB12#	
		±0.5pF	GQM2195C2E2R0DB12#	±0.1pF				GQM2195C2E3R4BB12#		
		2.1pF	±0.05pF	GQM2195C2E2R1WB12#				±0.25pF	GQM2195C2E3R4CB12#	
			±0.1pF	GQM2195C2E2R1BB12#			±0.5pF	GQM2195C2E3R4DB12#		
			±0.25pF	GQM2195C2E2R1CB12#			3.5pF	±0.05pF	GQM2195C2E3R5WB12#	
		±0.5pF	GQM2195C2E2R1DB12#	±0.1pF				GQM2195C2E3R5BB12#		
		2.2pF	±0.05pF	GQM2195C2E2R2WB12#				±0.25pF	GQM2195C2E3R5CB12#	
			±0.1pF	GQM2195C2E2R2BB12#			±0.5pF	GQM2195C2E3R5DB12#		
			±0.25pF	GQM2195C2E2R2CB12#			3.6pF	±0.05pF	GQM2195C2E3R6WB12#	
		±0.5pF	GQM2195C2E2R2DB12#	±0.1pF				GQM2195C2E3R6BB12#		
		2.3pF	±0.05pF	GQM2195C2E2R3WB12#				±0.25pF	GQM2195C2E3R6CB12#	
			±0.1pF	GQM2195C2E2R3BB12#			±0.5pF	GQM2195C2E3R6DB12#		
			±0.25pF	GQM2195C2E2R3CB12#			3.7pF	±0.05pF	GQM2195C2E3R7WB12#	
		±0.5pF	GQM2195C2E2R3DB12#	±0.1pF				GQM2195C2E3R7BB12#		
		2.4pF	±0.05pF	GQM2195C2E2R4WB12#				±0.25pF	GQM2195C2E3R7CB12#	
			±0.1pF	GQM2195C2E2R4BB12#			±0.5pF	GQM2195C2E3R7DB12#		
			±0.25pF	GQM2195C2E2R4CB12#			3.8pF	±0.05pF	GQM2195C2E3R8WB12#	
		±0.5pF	GQM2195C2E2R4DB12#	±0.1pF				GQM2195C2E3R8BB12#		
		2.5pF	±0.05pF	GQM2195C2E2R5WB12#				±0.25pF	GQM2195C2E3R8CB12#	
			±0.1pF	GQM2195C2E2R5BB12#			±0.5pF	GQM2195C2E3R8DB12#		
			±0.25pF	GQM2195C2E2R5CB12#			3.9pF	±0.05pF	GQM2195C2E3R9WB12#	

Part number # indicates the package specification code.

GRM
 GR3
 GRJ
 GR4
 GJM
GQM
 GA2
 GA3 GB
 GA3 GD
 GA3 GF
 LLL
 LLA
 LLM
 LLR
 NFM
 GJ4
 ZRA
 ZRB
 KRM
 KR3
 GMA
 GMD
 ⚠Caution /Notice

GQM Series Temperature Compensating Type High Q Part Number List

(→ 2.0×1.25mm)

Rated Voltage	TC Code	Cap.	Tol.	Part Number	Rated Voltage	TC Code	Cap.	Tol.	Part Number	
250Vdc	COG	3.9pF	±0.1pF	GQM2195C2E3R9BB12#	250Vdc	COG	5.2pF	±0.5pF	GQM2195C2E5R2DB12#	
			±0.25pF	GQM2195C2E3R9CB12#				5.3pF	±0.05pF	GQM2195C2E5R3WB12#
			±0.5pF	GQM2195C2E3R9DB12#					±0.1pF	GQM2195C2E5R3BB12#
		4.0pF	±0.05pF	GQM2195C2E4R0WB12#			±0.25pF		GQM2195C2E5R3CB12#	
			±0.1pF	GQM2195C2E4R0BB12#			±0.5pF	GQM2195C2E5R3DB12#		
			±0.25pF	GQM2195C2E4R0CB12#			5.4pF	±0.05pF	GQM2195C2E5R4WB12#	
		±0.5pF	GQM2195C2E4R0DB12#	±0.1pF				GQM2195C2E5R4BB12#		
		4.1pF	±0.05pF	GQM2195C2E4R1WB12#				±0.25pF	GQM2195C2E5R4CB12#	
			±0.1pF	GQM2195C2E4R1BB12#			±0.5pF	GQM2195C2E5R4DB12#		
			±0.25pF	GQM2195C2E4R1CB12#			5.5pF	±0.05pF	GQM2195C2E5R5WB12#	
		±0.5pF	GQM2195C2E4R1DB12#	±0.1pF				GQM2195C2E5R5BB12#		
		4.2pF	±0.05pF	GQM2195C2E4R2WB12#				±0.25pF	GQM2195C2E5R5CB12#	
			±0.1pF	GQM2195C2E4R2BB12#			±0.5pF	GQM2195C2E5R5DB12#		
			±0.25pF	GQM2195C2E4R2CB12#			5.6pF	±0.05pF	GQM2195C2E5R6WB12#	
		±0.5pF	GQM2195C2E4R2DB12#	±0.1pF				GQM2195C2E5R6BB12#		
		4.3pF	±0.05pF	GQM2195C2E4R3WB12#				±0.25pF	GQM2195C2E5R6CB12#	
			±0.1pF	GQM2195C2E4R3BB12#			±0.5pF	GQM2195C2E5R6DB12#		
			±0.25pF	GQM2195C2E4R3CB12#			5.7pF	±0.05pF	GQM2195C2E5R7WB12#	
		±0.5pF	GQM2195C2E4R3DB12#	±0.1pF				GQM2195C2E5R7BB12#		
		4.4pF	±0.05pF	GQM2195C2E4R4WB12#				±0.25pF	GQM2195C2E5R7CB12#	
			±0.1pF	GQM2195C2E4R4BB12#			±0.5pF	GQM2195C2E5R7DB12#		
			±0.25pF	GQM2195C2E4R4CB12#			5.8pF	±0.05pF	GQM2195C2E5R8WB12#	
		±0.5pF	GQM2195C2E4R4DB12#	±0.1pF				GQM2195C2E5R8BB12#		
		4.5pF	±0.05pF	GQM2195C2E4R5WB12#				±0.25pF	GQM2195C2E5R8CB12#	
			±0.1pF	GQM2195C2E4R5BB12#			±0.5pF	GQM2195C2E5R8DB12#		
			±0.25pF	GQM2195C2E4R5CB12#			5.9pF	±0.05pF	GQM2195C2E5R9WB12#	
		±0.5pF	GQM2195C2E4R5DB12#	±0.1pF				GQM2195C2E5R9BB12#		
		4.6pF	±0.05pF	GQM2195C2E4R6WB12#				±0.25pF	GQM2195C2E5R9CB12#	
			±0.1pF	GQM2195C2E4R6BB12#			±0.5pF	GQM2195C2E5R9DB12#		
			±0.25pF	GQM2195C2E4R6CB12#			6.0pF	±0.05pF	GQM2195C2E6R0WB12#	
		±0.5pF	GQM2195C2E4R6DB12#	±0.1pF				GQM2195C2E6R0BB12#		
		4.7pF	±0.05pF	GQM2195C2E4R7WB12#				±0.25pF	GQM2195C2E6R0CB12#	
			±0.1pF	GQM2195C2E4R7BB12#			±0.5pF	GQM2195C2E6R0DB12#		
			±0.25pF	GQM2195C2E4R7CB12#			6.1pF	±0.05pF	GQM2195C2E6R1WB12#	
		±0.5pF	GQM2195C2E4R7DB12#	±0.1pF				GQM2195C2E6R1BB12#		
		4.8pF	±0.05pF	GQM2195C2E4R8WB12#				±0.25pF	GQM2195C2E6R1CB12#	
			±0.1pF	GQM2195C2E4R8BB12#			±0.5pF	GQM2195C2E6R1DB12#		
			±0.25pF	GQM2195C2E4R8CB12#			6.2pF	±0.05pF	GQM2195C2E6R2WB12#	
		±0.5pF	GQM2195C2E4R8DB12#	±0.1pF				GQM2195C2E6R2BB12#		
		4.9pF	±0.05pF	GQM2195C2E4R9WB12#				±0.25pF	GQM2195C2E6R2CB12#	
			±0.1pF	GQM2195C2E4R9BB12#			±0.5pF	GQM2195C2E6R2DB12#		
			±0.25pF	GQM2195C2E4R9CB12#			6.3pF	±0.05pF	GQM2195C2E6R3WB12#	
		±0.5pF	GQM2195C2E4R9DB12#	±0.1pF				GQM2195C2E6R3BB12#		
		5.0pF	±0.05pF	GQM2195C2E5R0WB12#				±0.25pF	GQM2195C2E6R3CB12#	
			±0.1pF	GQM2195C2E5R0BB12#			±0.5pF	GQM2195C2E6R3DB12#		
			±0.25pF	GQM2195C2E5R0CB12#			6.4pF	±0.05pF	GQM2195C2E6R4WB12#	
		±0.5pF	GQM2195C2E5R0DB12#	±0.1pF				GQM2195C2E6R4BB12#		
		5.1pF	±0.05pF	GQM2195C2E5R1WB12#				±0.25pF	GQM2195C2E6R4CB12#	
			±0.1pF	GQM2195C2E5R1BB12#			±0.5pF	GQM2195C2E6R4DB12#		
			±0.25pF	GQM2195C2E5R1CB12#			6.5pF	±0.05pF	GQM2195C2E6R5WB12#	
		±0.5pF	GQM2195C2E5R1DB12#	±0.1pF				GQM2195C2E6R5BB12#		
		5.2pF	±0.05pF	GQM2195C2E5R2WB12#				±0.25pF	GQM2195C2E6R5CB12#	
			±0.1pF	GQM2195C2E5R2BB12#			±0.5pF	GQM2195C2E6R5DB12#		
			±0.25pF	GQM2195C2E5R2CB12#			6.6pF	±0.05pF	GQM2195C2E6R6WB12#	

- GRM
- GR3
- GRJ
- GR4
- GJM
- GQM**
- GA2
- GA3 GB
- GA3 GD
- GA3 GF
- LLL
- LLA
- LLM
- LLR
- NFM
- GJ4
- ZRA
- ZRB
- KRM
- KR3
- GMA
- GMD
- ⚠Caution /Notice

Part number # indicates the package specification code.

GQM Series Temperature Compensating Type High Q Part Number List

(→ 2.0×1.25mm)

Rated Voltage	TC Code	Cap.	Tol.	Part Number	Rated Voltage	TC Code	Cap.	Tol.	Part Number
250Vdc	COG	6.6pF	±0.1pF	GQM2195C2E6R6BB12#	250Vdc	COG	8.3pF	±0.25pF	GQM2195C2E8R3CB12#
			±0.25pF	GQM2195C2E6R6CB12#				±0.5pF	GQM2195C2E8R3DB12#
			±0.5pF	GQM2195C2E6R6DB12#				8.4pF	±0.1pF
		6.7pF	±0.05pF	GQM2195C2E6R7WB12#			±0.25pF		GQM2195C2E8R4CB12#
			±0.1pF	GQM2195C2E6R7BB12#			±0.5pF		GQM2195C2E8R4DB12#
			±0.25pF	GQM2195C2E6R7CB12#			8.5pF	±0.1pF	GQM2195C2E8R5BB12#
		±0.5pF	GQM2195C2E6R7DB12#	±0.25pF				GQM2195C2E8R5CB12#	
		±0.5pF	GQM2195C2E6R8WB12#	±0.5pF				GQM2195C2E8R5DB12#	
		6.8pF	±0.05pF	GQM2195C2E6R8BB12#			8.6pF	±0.1pF	GQM2195C2E8R6BB12#
			±0.1pF	GQM2195C2E6R8CB12#				±0.25pF	GQM2195C2E8R6CB12#
			±0.25pF	GQM2195C2E6R8DB12#				±0.5pF	GQM2195C2E8R6DB12#
			±0.5pF	GQM2195C2E6R9BB12#				8.7pF	±0.1pF
		6.9pF	±0.25pF	GQM2195C2E6R9CB12#			±0.25pF		GQM2195C2E8R7CB12#
			±0.5pF	GQM2195C2E6R9DB12#			±0.5pF		GQM2195C2E8R7DB12#
			7.0pF	±0.1pF			GQM2195C2E7R0BB12#	8.8pF	±0.1pF
		±0.25pF		GQM2195C2E7R0CB12#			±0.25pF		GQM2195C2E8R8CB12#
		±0.5pF		GQM2195C2E7R0DB12#			±0.5pF		GQM2195C2E8R8DB12#
		7.1pF	±0.1pF	GQM2195C2E7R1BB12#			8.9pF	±0.1pF	GQM2195C2E8R9BB12#
			±0.25pF	GQM2195C2E7R1CB12#				±0.25pF	GQM2195C2E8R9CB12#
			±0.5pF	GQM2195C2E7R1DB12#				±0.5pF	GQM2195C2E8R9DB12#
		7.2pF	±0.1pF	GQM2195C2E7R2BB12#			9.0pF	±0.1pF	GQM2195C2E9R0BB12#
			±0.25pF	GQM2195C2E7R2CB12#				±0.25pF	GQM2195C2E9R0CB12#
			±0.5pF	GQM2195C2E7R2DB12#				±0.5pF	GQM2195C2E9R0DB12#
		7.3pF	±0.1pF	GQM2195C2E7R3BB12#			9.1pF	±0.1pF	GQM2195C2E9R1BB12#
			±0.25pF	GQM2195C2E7R3CB12#				±0.25pF	GQM2195C2E9R1CB12#
			±0.5pF	GQM2195C2E7R3DB12#				±0.5pF	GQM2195C2E9R1DB12#
		7.4pF	±0.1pF	GQM2195C2E7R4BB12#			9.2pF	±0.1pF	GQM2195C2E9R2BB12#
			±0.25pF	GQM2195C2E7R4CB12#				±0.25pF	GQM2195C2E9R2CB12#
			±0.5pF	GQM2195C2E7R4DB12#				±0.5pF	GQM2195C2E9R2DB12#
		7.5pF	±0.1pF	GQM2195C2E7R5BB12#			9.3pF	±0.1pF	GQM2195C2E9R3BB12#
			±0.25pF	GQM2195C2E7R5CB12#				±0.25pF	GQM2195C2E9R3CB12#
			±0.5pF	GQM2195C2E7R5DB12#				±0.5pF	GQM2195C2E9R3DB12#
		7.6pF	±0.1pF	GQM2195C2E7R6BB12#			9.4pF	±0.1pF	GQM2195C2E9R4BB12#
			±0.25pF	GQM2195C2E7R6CB12#				±0.25pF	GQM2195C2E9R4CB12#
			±0.5pF	GQM2195C2E7R6DB12#				±0.5pF	GQM2195C2E9R4DB12#
		7.7pF	±0.1pF	GQM2195C2E7R7BB12#			9.5pF	±0.1pF	GQM2195C2E9R5BB12#
			±0.25pF	GQM2195C2E7R7CB12#				±0.25pF	GQM2195C2E9R5CB12#
			±0.5pF	GQM2195C2E7R7DB12#				±0.5pF	GQM2195C2E9R5DB12#
		7.8pF	±0.1pF	GQM2195C2E7R8BB12#			9.6pF	±0.1pF	GQM2195C2E9R6BB12#
			±0.25pF	GQM2195C2E7R8CB12#				±0.25pF	GQM2195C2E9R6CB12#
			±0.5pF	GQM2195C2E7R8DB12#				±0.5pF	GQM2195C2E9R6DB12#
		7.9pF	±0.1pF	GQM2195C2E7R9BB12#			9.7pF	±0.1pF	GQM2195C2E9R7BB12#
			±0.25pF	GQM2195C2E7R9CB12#				±0.25pF	GQM2195C2E9R7CB12#
			±0.5pF	GQM2195C2E7R9DB12#				±0.5pF	GQM2195C2E9R7DB12#
		8.0pF	±0.1pF	GQM2195C2E8R0BB12#			9.8pF	±0.1pF	GQM2195C2E9R8BB12#
			±0.25pF	GQM2195C2E8R0CB12#				±0.25pF	GQM2195C2E9R8CB12#
			±0.5pF	GQM2195C2E8R0DB12#				±0.5pF	GQM2195C2E9R8DB12#
		8.1pF	±0.1pF	GQM2195C2E8R1BB12#			9.9pF	±0.1pF	GQM2195C2E9R9BB12#
			±0.25pF	GQM2195C2E8R1CB12#				±0.25pF	GQM2195C2E9R9CB12#
			±0.5pF	GQM2195C2E8R1DB12#				±0.5pF	GQM2195C2E9R9DB12#
		8.2pF	±0.1pF	GQM2195C2E8R2BB12#			10pF	±1%	GQM2195C2E100FB12#
			±0.25pF	GQM2195C2E8R2CB12#				±2%	GQM2195C2E100GB12#
			±0.5pF	GQM2195C2E8R2DB12#				±2.5%	GQM2195C2E100RB12#
		8.3pF	±0.1pF	GQM2195C2E8R3BB12#				±5%	GQM2195C2E100JB12#

- GRM
- GR3
- GRJ
- GR4
- GJM
- GQM**
- GA2
- GA3 GB
- GA3 GD
- GA3 GF
- LLL
- LLA
- LLM
- LLR
- NFM
- GJ4
- ZRA
- ZRB
- KRM
- KR3
- GMA
- GMD
- ⚠Caution /Notice

Part number # indicates the package specification code.

GQM Series Temperature Compensating Type High Q Part Number List

(→ 2.0×1.25mm)

Rated Voltage	TC Code	Cap.	Tol.	Part Number		Rated Voltage	TC Code	Cap.	Tol.	Part Number		
250Vdc	COG	11pF	±1%	GQM2195C2E110FB12#		250Vdc	COG	39pF	±1%	GQM2195C2E390FB12#		
			±2%	GQM2195C2E110GB12#					±2%	GQM2195C2E390GB12#		
			±5%	GQM2195C2E110JB12#					±5%	GQM2195C2E390JB12#		
		12pF	±1%	GQM2195C2E120FB12#				43pF	±1%	GQM2195C2E430FB12#		
			±2%	GQM2195C2E120GB12#					±2%	GQM2195C2E430GB12#		
			±5%	GQM2195C2E120JB12#					±5%	GQM2195C2E430JB12#		
		13pF	±1%	GQM2195C2E130FB12#				47pF	±1%	GQM2195C2E470FB12#		
			±2%	GQM2195C2E130GB12#					±2%	GQM2195C2E470GB12#		
			±5%	GQM2195C2E130JB12#					±5%	GQM2195C2E470JB12#		
		14pF	±1%	GQM2195C2E140FB12#				51pF	±1%	GQM2195C2E510FB12#		
			±2%	GQM2195C2E140GB12#					±2%	GQM2195C2E510GB12#		
			±5%	GQM2195C2E140JB12#					±5%	GQM2195C2E510JB12#		
		15pF	±1%	GQM2195C2E150FB12#				56pF	±1%	GQM2195C2E560FB12#		
			±2%	GQM2195C2E150GB12#					±2%	GQM2195C2E560GB12#		
			±5%	GQM2195C2E150JB12#					±5%	GQM2195C2E560JB12#		
		16pF	±1%	GQM2195C2E160FB12#				62pF	±1%	GQM2195C2E620FB12#		
			±2%	GQM2195C2E160GB12#					±2%	GQM2195C2E620GB12#		
			±5%	GQM2195C2E160JB12#					±5%	GQM2195C2E620JB12#		
		18pF	±1%	GQM2195C2E180FB12#				68pF	±1%	GQM2195C2E680FB12#		
			±2%	GQM2195C2E180GB12#					±2%	GQM2195C2E680GB12#		
			±5%	GQM2195C2E180JB12#					±5%	GQM2195C2E680JB12#		
		20pF	±1%	GQM2195C2E200FB12#				75pF	±1%	GQM2195C2E750FB12#		
			±2%	GQM2195C2E200GB12#					±2%	GQM2195C2E750GB12#		
			±5%	GQM2195C2E200JB12#					±5%	GQM2195C2E750JB12#		
		22pF	±1%	GQM2195C2E220FB12#				82pF	±1%	GQM2195C2E820FB12#		
			±2%	GQM2195C2E220GB12#					±2%	GQM2195C2E820GB12#		
			±5%	GQM2195C2E220JB12#					±5%	GQM2195C2E820JB12#		
		24pF	±1%	GQM2195C2E240FB12#				91pF	±1%	GQM2195C2E910FB12#		
			±2%	GQM2195C2E240GB12#					±2%	GQM2195C2E910GB12#		
			±5%	GQM2195C2E240JB12#					±5%	GQM2195C2E910JB12#		
		25pF	±1%	GQM2195C2E250FB12#				100pF	±1%	GQM2195C2E101FB12#		
			±2%	GQM2195C2E250GB12#					±2%	GQM2195C2E101GB12#		
			±5%	GQM2195C2E250JB12#					±5%	GQM2195C2E101JB12#		
		27pF	±1%	GQM2195C2E270FB12#				110pF	±1%	GQM2195C2E111FB12#		
			±2%	GQM2195C2E270GB12#					±2%	GQM2195C2E111GB12#		
			±5%	GQM2195C2E270JB12#					±5%	GQM2195C2E111JB12#		
		28pF	±1%	GQM2195C2E280FB12#				120pF	±1%	GQM2195C2E121FB12#		
			±2%	GQM2195C2E280GB12#					±2%	GQM2195C2E121GB12#		
			±5%	GQM2195C2E280JB12#					±5%	GQM2195C2E121JB12#		
		30pF	±1%	GQM2195C2E300FB12#				130pF	±1%	GQM2195C2E131FB12#		
			±2%	GQM2195C2E300GB12#					±2%	GQM2195C2E131GB12#		
			±5%	GQM2195C2E300JB12#					±5%	GQM2195C2E131JB12#		
		32pF	±1%	GQM2195C2E320FB12#				150pF	±1%	GQM2195C2E151FB12#		
			±2%	GQM2195C2E320GB12#					±2%	GQM2195C2E151GB12#		
			±5%	GQM2195C2E320JB12#					±5%	GQM2195C2E151JB12#		
		33pF	±1%	GQM2195C2E330FB12#				X8G	0.20pF	±0.05pF	GQM2195G2ER20WB12#	
			±2%	GQM2195C2E330GB12#						±0.1pF	GQM2195G2ER20BB12#	
			±5%	GQM2195C2E330JB12#					0.30pF	±0.05pF	GQM2195G2ER30WB12#	
		34pF	±1%	GQM2195C2E340FB12#						±0.1pF	GQM2195G2ER30BB12#	
			±2%	GQM2195C2E340GB12#						±0.25pF	GQM2195G2ER30CB12#	
			±5%	GQM2195C2E340JB12#					0.40pF	±0.05pF	GQM2195G2ER40WB12#	
		36pF	±1%	GQM2195C2E360FB12#						±0.1pF	GQM2195G2ER40BB12#	
			±2%	GQM2195C2E360GB12#						±0.25pF	GQM2195G2ER40CB12#	
			±5%	GQM2195C2E360JB12#					±0.05pF	GQM2195G2ER50WB12#		

- GRM
- GR3
- GRJ
- GR4
- GJM
- GQM**
- GA2
- GA3 GB
- GA3 GD
- GA3 GF
- LLL
- LLA
- LLM
- LLR
- NFM
- GJ4
- ZRA
- ZRB
- KRM
- KR3
- GMA
- GMD
- ⚠Caution /Notice

Part number # indicates the package specification code.

GQM Series Temperature Compensating Type High Q Part Number List

(→ 2.0×1.25mm)

Rated Voltage	TC Code	Cap.	Tol.	Part Number	Rated Voltage	TC Code	Cap.	Tol.	Part Number				
250Vdc	X8G	0.50pF	±0.1pF	GQM2195G2ER50BB12#	250Vdc	X8G	1.7pF	±0.5pF	GQM2195G2E1R7DB12#				
			±0.25pF	GQM2195G2ER50CB12#				1.8pF	±0.05pF	GQM2195G2E1R8WB12#			
			±0.5pF	GQM2195G2ER50DB12#					±0.1pF	GQM2195G2E1R8BB12#			
		±0.05pF	GQM2195G2ER60WB12#	±0.25pF			GQM2195G2E1R8CB12#						
		±0.1pF	GQM2195G2ER60BB12#	±0.5pF			GQM2195G2E1R8DB12#	1.9pF	±0.05pF	GQM2195G2E1R9WB12#			
		±0.25pF	GQM2195G2ER60CB12#	±0.1pF			GQM2195G2E1R9BB12#		±0.25pF	GQM2195G2E1R9CB12#			
		±0.5pF	GQM2195G2ER60DB12#	±0.5pF			GQM2195G2E1R9DB12#		2.0pF	±0.05pF	GQM2195G2E2R0WB12#		
		±0.05pF	GQM2195G2ER70WB12#	±0.1pF			GQM2195G2E2R0BB12#	±0.25pF		GQM2195G2E2R0CB12#			
		±0.1pF	GQM2195G2ER70BB12#	±0.5pF			GQM2195G2E2R0DB12#	2.1pF		±0.05pF	GQM2195G2E2R1WB12#		
		±0.25pF	GQM2195G2ER70CB12#	±0.1pF			GQM2195G2E2R1BB12#		±0.25pF	GQM2195G2E2R1CB12#			
		±0.5pF	GQM2195G2ER70DB12#	±0.5pF			GQM2195G2E2R1DB12#		2.2pF	±0.05pF	GQM2195G2E2R2WB12#		
		±0.05pF	GQM2195G2ER75WB12#	±0.1pF			GQM2195G2E2R2BB12#	±0.25pF		GQM2195G2E2R2CB12#			
		±0.1pF	GQM2195G2ER75BB12#	±0.5pF			GQM2195G2E2R2DB12#	2.3pF		±0.05pF	GQM2195G2E2R3WB12#		
		±0.25pF	GQM2195G2ER75CB12#	±0.1pF			GQM2195G2E2R3BB12#		±0.25pF	GQM2195G2E2R3CB12#			
		±0.5pF	GQM2195G2ER75DB12#	±0.5pF			GQM2195G2E2R3DB12#		2.4pF	±0.05pF	GQM2195G2E2R4WB12#		
		±0.05pF	GQM2195G2ER80WB12#	±0.1pF			GQM2195G2E2R4BB12#	±0.25pF		GQM2195G2E2R4CB12#			
		±0.1pF	GQM2195G2ER80BB12#	±0.5pF			GQM2195G2E2R4DB12#	2.5pF		±0.05pF	GQM2195G2E2R5WB12#		
		±0.25pF	GQM2195G2ER80CB12#	±0.1pF			GQM2195G2E2R5BB12#		±0.25pF	GQM2195G2E2R5CB12#			
		±0.5pF	GQM2195G2ER80DB12#	±0.5pF			GQM2195G2E2R5DB12#		2.6pF	±0.05pF	GQM2195G2E2R6WB12#		
		±0.05pF	GQM2195G2ER90WB12#	±0.1pF			GQM2195G2E2R6BB12#	±0.25pF		GQM2195G2E2R6CB12#			
		±0.1pF	GQM2195G2ER90BB12#	±0.5pF			GQM2195G2E2R6DB12#	2.7pF		±0.05pF	GQM2195G2E2R7WB12#		
		±0.25pF	GQM2195G2ER90CB12#	±0.1pF			GQM2195G2E2R7BB12#		±0.25pF	GQM2195G2E2R7CB12#			
		±0.5pF	GQM2195G2ER90DB12#	±0.5pF			GQM2195G2E2R7DB12#		2.8pF	±0.05pF	GQM2195G2E2R8WB12#		
		±0.05pF	GQM2195G2E1R0WB12#	±0.1pF			GQM2195G2E1R0BB12#	±0.1pF		GQM2195G2E2R8BB12#			
		±0.1pF	GQM2195G2E1R0BB12#	±0.25pF			GQM2195G2E1R0CB12#	±0.25pF		GQM2195G2E2R8CB12#			
		±0.25pF	GQM2195G2E1R0CB12#	±0.5pF			GQM2195G2E1R0DB12#	±0.5pF	GQM2195G2E2R8DB12#	2.9pF	±0.05pF	GQM2195G2E2R9WB12#	
		±0.5pF	GQM2195G2E1R0DB12#	±0.05pF			GQM2195G2E1R1WB12#	±0.1pF	GQM2195G2E2R9BB12#		±0.25pF	GQM2195G2E2R9CB12#	
		±0.05pF	GQM2195G2E1R1WB12#	±0.1pF			GQM2195G2E1R1BB12#	±0.5pF	GQM2195G2E2R9DB12#		3.0pF	±0.05pF	GQM2195G2E3R0WB12#
		±0.1pF	GQM2195G2E1R1BB12#	±0.25pF			GQM2195G2E1R1CB12#	±0.1pF	GQM2195G2E3R0BB12#	±0.25pF		GQM2195G2E3R0CB12#	
		±0.25pF	GQM2195G2E1R1CB12#	±0.5pF			GQM2195G2E1R1DB12#	±0.5pF	GQM2195G2E3R0DB12#	3.1pF		±0.05pF	GQM2195G2E3R1WB12#
		±0.5pF	GQM2195G2E1R1DB12#	±0.05pF			GQM2195G2E1R2WB12#	±0.1pF	GQM2195G2E3R1BB12#				
		±0.05pF	GQM2195G2E1R2WB12#	±0.1pF			GQM2195G2E1R2BB12#	±0.25pF	GQM2195G2E3R1CB12#				
		±0.1pF	GQM2195G2E1R2BB12#	±0.25pF			GQM2195G2E1R2CB12#	±0.5pF	GQM2195G2E3R1DB12#				
		±0.25pF	GQM2195G2E1R2CB12#	±0.05pF			GQM2195G2E1R3WB12#						
		±0.5pF	GQM2195G2E1R2DB12#	±0.1pF			GQM2195G2E1R3BB12#						
		±0.05pF	GQM2195G2E1R3WB12#	±0.25pF			GQM2195G2E1R3CB12#						
		±0.1pF	GQM2195G2E1R3BB12#	±0.5pF			GQM2195G2E1R3DB12#						
		±0.25pF	GQM2195G2E1R3CB12#	±0.05pF			GQM2195G2E1R4WB12#						
		±0.5pF	GQM2195G2E1R3DB12#	±0.1pF			GQM2195G2E1R4BB12#						
		±0.05pF	GQM2195G2E1R4WB12#	±0.25pF			GQM2195G2E1R4CB12#						
		±0.1pF	GQM2195G2E1R4BB12#	±0.5pF			GQM2195G2E1R4DB12#						
		±0.25pF	GQM2195G2E1R4CB12#	±0.05pF			GQM2195G2E1R5WB12#						
		±0.5pF	GQM2195G2E1R4DB12#	±0.1pF			GQM2195G2E1R5BB12#						
		±0.05pF	GQM2195G2E1R5WB12#	±0.25pF			GQM2195G2E1R5CB12#						
		±0.1pF	GQM2195G2E1R5BB12#	±0.5pF			GQM2195G2E1R5DB12#						
		±0.25pF	GQM2195G2E1R5CB12#	±0.05pF			GQM2195G2E1R6WB12#						
		±0.5pF	GQM2195G2E1R5DB12#	±0.1pF			GQM2195G2E1R6BB12#						
		±0.05pF	GQM2195G2E1R6WB12#	±0.25pF			GQM2195G2E1R6CB12#						
		±0.1pF	GQM2195G2E1R6BB12#	±0.5pF			GQM2195G2E1R6DB12#						
		±0.25pF	GQM2195G2E1R6CB12#	±0.05pF			GQM2195G2E1R7WB12#						
		±0.5pF	GQM2195G2E1R6DB12#	±0.1pF			GQM2195G2E1R7BB12#						
		±0.05pF	GQM2195G2E1R7WB12#	±0.25pF			GQM2195G2E1R7CB12#						
		±0.1pF	GQM2195G2E1R7BB12#										
		±0.25pF	GQM2195G2E1R7CB12#										

Part number # indicates the package specification code.

GRM
 GR3
 GRJ
 GR4
 GJM
 GQM
 GA2
 GA3 GB
 GA3 GD
 GA3 GF
 LLL
 LLA
 LLM
 LLR
 NFM
 GJ4
 ZRA
 ZRB
 KRM
 KR3
 GMA
 GMD
 △Caution /Notice

GQM Series Temperature Compensating Type High Q Part Number List

(→ 2.0×1.25mm)

Rated Voltage	TC Code	Cap.	Tol.	Part Number	Rated Voltage	TC Code	Cap.	Tol.	Part Number				
250Vdc	X8G	3.1pF	±0.1pF	GQM2195G2E3R1BB12#	250Vdc	X8G	4.4pF	±0.5pF	GQM2195G2E4R4DB12#				
			±0.25pF	GQM2195G2E3R1CB12#				4.5pF	±0.05pF	GQM2195G2E4R5WB12#			
			±0.5pF	GQM2195G2E3R1DB12#					±0.1pF	GQM2195G2E4R5BB12#			
		±0.05pF	GQM2195G2E3R2WB12#	±0.25pF			GQM2195G2E4R5CB12#						
		±0.1pF	GQM2195G2E3R2BB12#	±0.5pF			GQM2195G2E4R5DB12#	4.6pF	±0.05pF	GQM2195G2E4R6WB12#			
		±0.25pF	GQM2195G2E3R2CB12#	±0.1pF			GQM2195G2E4R6BB12#		±0.25pF	GQM2195G2E4R6CB12#			
		±0.5pF	GQM2195G2E3R2DB12#	±0.5pF			GQM2195G2E4R6DB12#		4.7pF	±0.05pF	GQM2195G2E4R7WB12#		
		±0.05pF	GQM2195G2E3R3WB12#	±0.1pF			GQM2195G2E4R7BB12#	±0.1pF		GQM2195G2E4R7CB12#			
		±0.1pF	GQM2195G2E3R3BB12#	±0.25pF			GQM2195G2E4R7DB12#	±0.25pF		GQM2195G2E4R7CB12#			
		±0.25pF	GQM2195G2E3R3CB12#	3.4pF			±0.5pF	GQM2195G2E3R3DB12#	4.8pF	±0.05pF	GQM2195G2E4R8WB12#		
		±0.5pF	GQM2195G2E3R4WB12#				±0.1pF	GQM2195G2E4R8BB12#		±0.25pF	GQM2195G2E4R8CB12#		
		±0.1pF	GQM2195G2E3R4BB12#				±0.5pF	GQM2195G2E4R8DB12#		4.9pF	±0.05pF	GQM2195G2E4R9WB12#	
		±0.25pF	GQM2195G2E3R4CB12#	±0.1pF			GQM2195G2E4R9BB12#	±0.1pF	GQM2195G2E4R9CB12#				
		±0.5pF	GQM2195G2E3R4DB12#	±0.25pF			GQM2195G2E4R9DB12#	±0.25pF	GQM2195G2E4R9CB12#				
		3.5pF	±0.05pF	GQM2195G2E3R5WB12#			3.6pF	±0.05pF	GQM2195G2E3R6WB12#	5.0pF	±0.05pF	GQM2195G2E5R0WB12#	
			±0.1pF	GQM2195G2E3R5BB12#				±0.1pF	GQM2195G2E3R6BB12#		±0.1pF	GQM2195G2E5R0BB12#	
			±0.25pF	GQM2195G2E3R5CB12#				±0.25pF	GQM2195G2E3R6CB12#		±0.25pF	GQM2195G2E5R0CB12#	
		±0.5pF	GQM2195G2E3R5DB12#	±0.5pF			GQM2195G2E3R6DB12#	±0.5pF	GQM2195G2E5R0DB12#	5.1pF	±0.05pF	GQM2195G2E5R1WB12#	
		±0.05pF	GQM2195G2E3R7WB12#	±0.1pF			GQM2195G2E3R7BB12#	±0.1pF	GQM2195G2E5R1BB12#		±0.1pF	GQM2195G2E5R1BB12#	
		±0.1pF	GQM2195G2E3R7BB12#	±0.25pF			GQM2195G2E3R7CB12#	±0.25pF	GQM2195G2E3R8CB12#		±0.25pF	GQM2195G2E5R1CB12#	
		±0.25pF	GQM2195G2E3R7CB12#	3.7pF			±0.5pF	GQM2195G2E3R7DB12#	3.8pF	±0.05pF	GQM2195G2E3R8WB12#	±0.5pF	GQM2195G2E5R1DB12#
		±0.5pF	GQM2195G2E3R5DB12#				±0.1pF	GQM2195G2E3R8BB12#		±0.1pF	GQM2195G2E3R8BB12#	±0.1pF	GQM2195G2E5R1DB12#
		±0.05pF	GQM2195G2E3R6WB12#				±0.25pF	GQM2195G2E3R8CB12#		±0.25pF	GQM2195G2E3R8CB12#	±0.25pF	GQM2195G2E5R1CB12#
		±0.1pF	GQM2195G2E3R6BB12#	3.8pF			±0.5pF	GQM2195G2E3R8DB12#	3.9pF	±0.05pF	GQM2195G2E3R9WB12#	±0.5pF	GQM2195G2E5R2WB12#
		±0.25pF	GQM2195G2E3R6CB12#				±0.1pF	GQM2195G2E3R9BB12#		±0.1pF	GQM2195G2E3R9BB12#	±0.1pF	GQM2195G2E5R2BB12#
		±0.5pF	GQM2195G2E3R6DB12#				±0.25pF	GQM2195G2E3R9CB12#		±0.25pF	GQM2195G2E3R9CB12#	±0.25pF	GQM2195G2E5R2CB12#
		±0.05pF	GQM2195G2E3R7WB12#	4.0pF			±0.1pF	GQM2195G2E3R9DB12#	4.0pF	±0.05pF	GQM2195G2E4R0WB12#	±0.5pF	GQM2195G2E5R2DB12#
		±0.1pF	GQM2195G2E3R7BB12#				±0.1pF	GQM2195G2E4R0BB12#		±0.1pF	GQM2195G2E4R0BB12#	±0.1pF	GQM2195G2E5R3WB12#
		±0.25pF	GQM2195G2E3R7CB12#				±0.25pF	GQM2195G2E4R0CB12#		±0.25pF	GQM2195G2E4R0CB12#	±0.25pF	GQM2195G2E5R3CB12#
		±0.5pF	GQM2195G2E3R8WB12#	4.1pF			±0.5pF	GQM2195G2E4R0DB12#	4.1pF	±0.05pF	GQM2195G2E4R1WB12#	±0.5pF	GQM2195G2E5R3DB12#
		±0.1pF	GQM2195G2E3R8BB12#				±0.05pF	GQM2195G2E4R1BB12#		±0.05pF	GQM2195G2E4R1BB12#	±0.05pF	GQM2195G2E5R3BB12#
		±0.25pF	GQM2195G2E3R8CB12#				±0.1pF	GQM2195G2E4R1CB12#		±0.1pF	GQM2195G2E4R1CB12#	±0.1pF	GQM2195G2E5R3BB12#
		±0.5pF	GQM2195G2E3R8DB12#	4.2pF			±0.25pF	GQM2195G2E4R1DB12#	4.2pF	±0.05pF	GQM2195G2E4R2WB12#	±0.25pF	GQM2195G2E5R5WB12#
		±0.05pF	GQM2195G2E3R9WB12#				±0.25pF	GQM2195G2E4R2CB12#		±0.05pF	GQM2195G2E4R2WB12#	±0.05pF	GQM2195G2E5R5BB12#
		±0.1pF	GQM2195G2E3R9BB12#				±0.5pF	GQM2195G2E4R2DB12#		±0.1pF	GQM2195G2E4R2BB12#	±0.1pF	GQM2195G2E5R5BB12#
		±0.25pF	GQM2195G2E3R9CB12#	4.3pF			±0.5pF	GQM2195G2E4R2DB12#	4.3pF	±0.05pF	GQM2195G2E4R3WB12#	±0.25pF	GQM2195G2E5R5CB12#
		±0.5pF	GQM2195G2E3R9DB12#				±0.05pF	GQM2195G2E4R3BB12#		±0.05pF	GQM2195G2E4R3BB12#	±0.05pF	GQM2195G2E5R5CB12#
		±0.05pF	GQM2195G2E4R0WB12#				±0.1pF	GQM2195G2E4R3CB12#		±0.1pF	GQM2195G2E4R3CB12#	±0.1pF	GQM2195G2E5R5DB12#
		±0.1pF	GQM2195G2E4R0BB12#	4.4pF			±0.25pF	GQM2195G2E4R3DB12#	4.4pF	±0.05pF	GQM2195G2E4R4WB12#	±0.5pF	GQM2195G2E5R6WB12#
		±0.25pF	GQM2195G2E4R0CB12#				±0.5pF	GQM2195G2E4R4BB12#		±0.05pF	GQM2195G2E4R4BB12#	±0.05pF	GQM2195G2E5R6BB12#
		±0.5pF	GQM2195G2E4R0DB12#				±0.25pF	GQM2195G2E4R4CB12#		±0.25pF	GQM2195G2E4R4CB12#	±0.25pF	GQM2195G2E5R6CB12#
		±0.05pF	GQM2195G2E4R1WB12#	4.4pF			±0.1pF	GQM2195G2E4R4BB12#	4.4pF	±0.1pF	GQM2195G2E4R4BB12#	±0.5pF	GQM2195G2E5R6DB12#
		±0.1pF	GQM2195G2E4R1BB12#				±0.5pF	GQM2195G2E4R4DB12#		±0.1pF	GQM2195G2E4R4BB12#	±0.1pF	GQM2195G2E5R6BB12#
		±0.25pF	GQM2195G2E4R1CB12#				±0.05pF	GQM2195G2E4R4WB12#		±0.25pF	GQM2195G2E4R4CB12#	±0.25pF	GQM2195G2E5R6CB12#
		±0.5pF	GQM2195G2E4R1DB12#	4.4pF			±0.25pF	GQM2195G2E4R4CB12#	4.4pF	±0.25pF	GQM2195G2E4R4CB12#	±0.5pF	GQM2195G2E5R6DB12#
		±0.5pF	GQM2195G2E4R1DB12#				±0.1pF	GQM2195G2E4R4BB12#		±0.5pF	GQM2195G2E4R4DB12#	±0.5pF	GQM2195G2E5R6DB12#
		±0.05pF	GQM2195G2E4R2WB12#				±0.25pF	GQM2195G2E4R4CB12#		±0.25pF	GQM2195G2E4R4CB12#	±0.25pF	GQM2195G2E5R6CB12#
		±0.1pF	GQM2195G2E4R2BB12#	4.4pF			±0.5pF	GQM2195G2E4R3DB12#	4.4pF	±0.5pF	GQM2195G2E4R3DB12#	±0.05pF	GQM2195G2E5R7WB12#
		±0.25pF	GQM2195G2E4R2CB12#				±0.1pF	GQM2195G2E4R4BB12#		±0.05pF	GQM2195G2E4R4BB12#	±0.05pF	GQM2195G2E5R7BB12#
		±0.5pF	GQM2195G2E4R2DB12#				±0.25pF	GQM2195G2E4R4CB12#		±0.1pF	GQM2195G2E4R4BB12#	±0.1pF	GQM2195G2E5R7BB12#
		±0.05pF	GQM2195G2E4R3WB12#	4.4pF			±0.5pF	GQM2195G2E4R4CB12#	4.4pF	±0.25pF	GQM2195G2E4R4CB12#	±0.25pF	GQM2195G2E5R7CB12#
		±0.1pF	GQM2195G2E4R3BB12#				±0.5pF	GQM2195G2E4R4DB12#		±0.25pF	GQM2195G2E4R4CB12#	±0.25pF	GQM2195G2E5R7CB12#
		±0.25pF	GQM2195G2E4R3CB12#				±0.05pF	GQM2195G2E4R4WB12#		±0.5pF	GQM2195G2E4R4DB12#	±0.5pF	GQM2195G2E5R7DB12#
		±0.5pF	GQM2195G2E4R3DB12#	4.4pF			±0.25pF	GQM2195G2E4R4CB12#	4.4pF	±0.25pF	GQM2195G2E4R4CB12#	±0.05pF	GQM2195G2E5R8WB12#
		±0.5pF	GQM2195G2E4R3DB12#				±0.1pF	GQM2195G2E4R4BB12#		±0.5pF	GQM2195G2E4R4DB12#	±0.5pF	GQM2195G2E5R8WB12#
		±0.05pF	GQM2195G2E4R4WB12#				±0.25pF	GQM2195G2E4R4CB12#		±0.25pF	GQM2195G2E4R4CB12#	±0.25pF	GQM2195G2E5R8WB12#

Part number # indicates the package specification code.

- GRM
- GR3
- GRJ
- GR4
- GJM
- GQM**
- GA2
- GA3 GB
- GA3 GD
- GA3 GF
- LLL
- LLA
- LLM
- LLR
- NFM
- GJ4
- ZRA
- ZRB
- KRM
- KR3
- GMA
- GMD
- △Caution / Notice

GQM Series Temperature Compensating Type High Q Part Number List

(→ 2.0×1.25mm)

Rated Voltage	TC Code	Cap.	Tol.	Part Number	Rated Voltage	TC Code	Cap.	Tol.	Part Number	
250Vdc	X8G	5.8pF	±0.1pF	GQM2195G2E5R8BB12#	250Vdc	X8G	7.2pF	±0.5pF	GQM2195G2E7R2DB12#	
			±0.25pF	GQM2195G2E5R8CB12#				7.3pF	±0.1pF	GQM2195G2E7R3BB12#
			±0.5pF	GQM2195G2E5R8DB12#					±0.25pF	GQM2195G2E7R3CB12#
		5.9pF	±0.05pF	GQM2195G2E5R9WB12#			7.4pF	±0.5pF	GQM2195G2E7R3DB12#	
			±0.1pF	GQM2195G2E5R9BB12#				7.4pF	±0.1pF	GQM2195G2E7R4BB12#
			±0.25pF	GQM2195G2E5R9CB12#			±0.25pF		GQM2195G2E7R4CB12#	
		±0.5pF	GQM2195G2E5R9DB12#	±0.5pF			GQM2195G2E7R4DB12#			
		6.0pF	±0.05pF	GQM2195G2E6R0WB12#			7.5pF	±0.1pF	GQM2195G2E7R5BB12#	
			±0.1pF	GQM2195G2E6R0BB12#				±0.25pF	GQM2195G2E7R5CB12#	
			±0.25pF	GQM2195G2E6R0CB12#				±0.5pF	GQM2195G2E7R5DB12#	
			±0.5pF	GQM2195G2E6R0DB12#			7.6pF	±0.1pF	GQM2195G2E7R6BB12#	
		6.1pF	±0.05pF	GQM2195G2E6R1WB12#				±0.25pF	GQM2195G2E7R6CB12#	
			±0.1pF	GQM2195G2E6R1BB12#				±0.5pF	GQM2195G2E7R6DB12#	
			±0.25pF	GQM2195G2E6R1CB12#			7.7pF	±0.1pF	GQM2195G2E7R7BB12#	
		±0.5pF	GQM2195G2E6R1DB12#	±0.25pF				GQM2195G2E7R7CB12#		
		6.2pF	±0.05pF	GQM2195G2E6R2WB12#				±0.5pF	GQM2195G2E7R7DB12#	
			±0.1pF	GQM2195G2E6R2BB12#			7.8pF	±0.1pF	GQM2195G2E7R8BB12#	
			±0.25pF	GQM2195G2E6R2CB12#				±0.25pF	GQM2195G2E7R8CB12#	
			±0.5pF	GQM2195G2E6R2DB12#				±0.5pF	GQM2195G2E7R8DB12#	
		6.3pF	±0.05pF	GQM2195G2E6R3WB12#			7.9pF	±0.1pF	GQM2195G2E7R9BB12#	
			±0.1pF	GQM2195G2E6R3BB12#				±0.25pF	GQM2195G2E7R9CB12#	
			±0.25pF	GQM2195G2E6R3CB12#				±0.5pF	GQM2195G2E7R9DB12#	
			±0.5pF	GQM2195G2E6R3DB12#			8.0pF	±0.1pF	GQM2195G2E8R0BB12#	
		6.4pF	±0.05pF	GQM2195G2E6R4WB12#				±0.25pF	GQM2195G2E8R0CB12#	
			±0.1pF	GQM2195G2E6R4BB12#				±0.5pF	GQM2195G2E8R0DB12#	
			±0.25pF	GQM2195G2E6R4CB12#			8.1pF	±0.1pF	GQM2195G2E8R1BB12#	
			±0.5pF	GQM2195G2E6R4DB12#				±0.25pF	GQM2195G2E8R1CB12#	
		6.5pF	±0.05pF	GQM2195G2E6R5WB12#				±0.5pF	GQM2195G2E8R1DB12#	
			±0.1pF	GQM2195G2E6R5BB12#			8.2pF	±0.1pF	GQM2195G2E8R2BB12#	
			±0.25pF	GQM2195G2E6R5CB12#				±0.25pF	GQM2195G2E8R2CB12#	
			±0.5pF	GQM2195G2E6R5DB12#				±0.5pF	GQM2195G2E8R2DB12#	
		6.6pF	±0.05pF	GQM2195G2E6R6WB12#			8.3pF	±0.1pF	GQM2195G2E8R3BB12#	
			±0.1pF	GQM2195G2E6R6BB12#				±0.25pF	GQM2195G2E8R3CB12#	
			±0.25pF	GQM2195G2E6R6CB12#				±0.5pF	GQM2195G2E8R3DB12#	
			±0.5pF	GQM2195G2E6R6DB12#			8.4pF	±0.1pF	GQM2195G2E8R4BB12#	
		6.7pF	±0.05pF	GQM2195G2E6R7WB12#				±0.25pF	GQM2195G2E8R4CB12#	
			±0.1pF	GQM2195G2E6R7BB12#				±0.5pF	GQM2195G2E8R4DB12#	
			±0.25pF	GQM2195G2E6R7CB12#			8.5pF	±0.1pF	GQM2195G2E8R5BB12#	
			±0.5pF	GQM2195G2E6R7DB12#				±0.25pF	GQM2195G2E8R5CB12#	
		6.8pF	±0.05pF	GQM2195G2E6R8WB12#				±0.5pF	GQM2195G2E8R5DB12#	
			±0.1pF	GQM2195G2E6R8BB12#			8.6pF	±0.1pF	GQM2195G2E8R6BB12#	
			±0.25pF	GQM2195G2E6R8CB12#				±0.25pF	GQM2195G2E8R6CB12#	
			±0.5pF	GQM2195G2E6R8DB12#				±0.5pF	GQM2195G2E8R6DB12#	
		6.9pF	±0.1pF	GQM2195G2E6R9BB12#			8.7pF	±0.1pF	GQM2195G2E8R7BB12#	
			±0.25pF	GQM2195G2E6R9CB12#				±0.25pF	GQM2195G2E8R7CB12#	
			±0.5pF	GQM2195G2E6R9DB12#				±0.5pF	GQM2195G2E8R7DB12#	
		7.0pF	±0.1pF	GQM2195G2E7R0BB12#			8.8pF	±0.1pF	GQM2195G2E8R8BB12#	
			±0.25pF	GQM2195G2E7R0CB12#				±0.25pF	GQM2195G2E8R8CB12#	
			±0.5pF	GQM2195G2E7R0DB12#				±0.5pF	GQM2195G2E8R8DB12#	
		7.1pF	±0.1pF	GQM2195G2E7R1BB12#			8.9pF	±0.1pF	GQM2195G2E8R9BB12#	
			±0.25pF	GQM2195G2E7R1CB12#				±0.25pF	GQM2195G2E8R9CB12#	
			±0.5pF	GQM2195G2E7R1DB12#				±0.5pF	GQM2195G2E8R9DB12#	
		7.2pF	±0.1pF	GQM2195G2E7R2BB12#			9.0pF	±0.1pF	GQM2195G2E9R0BB12#	
			±0.25pF	GQM2195G2E7R2CB12#				±0.25pF	GQM2195G2E9R0CB12#	

Part number # indicates the package specification code.

- GRM
- GR3
- GRJ
- GR4
- GJM
- GQM**
- GA2
- GA3 GB
- GA3 GD
- GA3 GF
- LLL
- LLA
- LLM
- LLR
- NFM
- GJ4
- ZRA
- ZRB
- KRM
- KR3
- GMA
- GMD
- △Caution /Notice

GQM Series Temperature Compensating Type High Q Part Number List

(→ 2.0×1.25mm)

Rated Voltage	TC Code	Cap.	Tol.	Part Number		Rated Voltage	TC Code	Cap.	Tol.	Part Number	
250Vdc	X8G	9.0pF	±0.5pF	GQM2195G2E9R0DB12#		250Vdc	X8G	20pF	±2%	GQM2195G2E200GB12#	
			±0.1pF	GQM2195G2E9R1BB12#					±5%	GQM2195G2E200JB12#	
			±0.25pF	GQM2195G2E9R1CB12#					±1%	GQM2195G2E220FB12#	
		±0.5pF	GQM2195G2E9R1DB12#		±2%			GQM2195G2E220GB12#			
		9.2pF	±0.1pF	GQM2195G2E9R2BB12#				±5%	GQM2195G2E220JB12#		
			±0.25pF	GQM2195G2E9R2CB12#				24pF	±1%	GQM2195G2E240FB12#	
			±0.5pF	GQM2195G2E9R2DB12#					±2%	GQM2195G2E240GB12#	
		±0.1pF	GQM2195G2E9R3BB12#		±5%				GQM2195G2E240JB12#		
		9.3pF	±0.25pF	GQM2195G2E9R3CB12#				25pF	±1%	GQM2195G2E250FB12#	
			±0.5pF	GQM2195G2E9R3DB12#					±2%	GQM2195G2E250GB12#	
			±0.1pF	GQM2195G2E9R4BB12#					±5%	GQM2195G2E250JB12#	
		9.4pF	±0.25pF	GQM2195G2E9R4CB12#				27pF	±1%	GQM2195G2E270FB12#	
			±0.5pF	GQM2195G2E9R4DB12#					±2%	GQM2195G2E270GB12#	
			±0.1pF	GQM2195G2E9R5BB12#					±5%	GQM2195G2E270JB12#	
		9.5pF	±0.25pF	GQM2195G2E9R5CB12#				28pF	±1%	GQM2195G2E280FB12#	
			±0.5pF	GQM2195G2E9R5DB12#					±2%	GQM2195G2E280GB12#	
			±0.1pF	GQM2195G2E9R6BB12#					±5%	GQM2195G2E280JB12#	
		9.6pF	±0.25pF	GQM2195G2E9R6CB12#				30pF	±1%	GQM2195G2E300FB12#	
			±0.5pF	GQM2195G2E9R6DB12#					±2%	GQM2195G2E300GB12#	
			±0.1pF	GQM2195G2E9R7BB12#					±5%	GQM2195G2E300JB12#	
		9.7pF	±0.25pF	GQM2195G2E9R7CB12#				32pF	±1%	GQM2195G2E320FB12#	
			±0.5pF	GQM2195G2E9R7DB12#					±2%	GQM2195G2E320GB12#	
			±0.1pF	GQM2195G2E9R8BB12#					±5%	GQM2195G2E320JB12#	
		9.8pF	±0.25pF	GQM2195G2E9R8CB12#				33pF	±1%	GQM2195G2E330FB12#	
			±0.5pF	GQM2195G2E9R8DB12#					±2%	GQM2195G2E330GB12#	
			±0.1pF	GQM2195G2E9R9BB12#					±5%	GQM2195G2E330JB12#	
		9.9pF	±0.25pF	GQM2195G2E9R9CB12#				34pF	±1%	GQM2195G2E340FB12#	
			±0.5pF	GQM2195G2E9R9DB12#					±2%	GQM2195G2E340GB12#	
			±1%	GQM2195G2E100FB12#					±5%	GQM2195G2E340JB12#	
		10pF	±2%	GQM2195G2E100GB12#				36pF	±1%	GQM2195G2E360FB12#	
			±2.5%	GQM2195G2E100RB12#					±2%	GQM2195G2E360GB12#	
			±5%	GQM2195G2E100JB12#					±5%	GQM2195G2E360JB12#	
			±1%	GQM2195G2E110FB12#					39pF	±1%	GQM2195G2E390FB12#
		±2%	GQM2195G2E110GB12#		±2%			GQM2195G2E390GB12#			
		±5%	GQM2195G2E110JB12#		±5%			GQM2195G2E390JB12#			
		12pF	±1%	GQM2195G2E120FB12#				43pF	±1%	GQM2195G2E430FB12#	
			±2%	GQM2195G2E120GB12#					±2%	GQM2195G2E430GB12#	
			±5%	GQM2195G2E120JB12#					±5%	GQM2195G2E430JB12#	
		13pF	±1%	GQM2195G2E130FB12#				47pF	±1%	GQM2195G2E470FB12#	
			±2%	GQM2195G2E130GB12#					±2%	GQM2195G2E470GB12#	
			±5%	GQM2195G2E130JB12#					±5%	GQM2195G2E470JB12#	
		14pF	±1%	GQM2195G2E140FB12#				51pF	±1%	GQM2195G2E510FB12#	
±2%	GQM2195G2E140GB12#			±2%	GQM2195G2E510GB12#						
±5%	GQM2195G2E140JB12#			±5%	GQM2195G2E510JB12#						
15pF	±1%	GQM2195G2E150FB12#		56pF	±1%	GQM2195G2E560FB12#					
	±2%	GQM2195G2E150GB12#			±2%	GQM2195G2E560GB12#					
	±5%	GQM2195G2E150JB12#			±5%	GQM2195G2E560JB12#					
16pF	±1%	GQM2195G2E160FB12#		62pF	±1%	GQM2195G2E620FB12#					
	±2%	GQM2195G2E160GB12#			±2%	GQM2195G2E620GB12#					
	±5%	GQM2195G2E160JB12#			±5%	GQM2195G2E620JB12#					
18pF	±1%	GQM2195G2E180FB12#		68pF	±1%	GQM2195G2E680FB12#					
	±2%	GQM2195G2E180GB12#			±2%	GQM2195G2E680GB12#					
	±5%	GQM2195G2E180JB12#			±5%	GQM2195G2E680JB12#					
20pF	±1%	GQM2195G2E200FB12#		75pF	±1%	GQM2195G2E750FB12#					

- GRM
- GR3
- GRJ
- GR4
- GJM
- GQM**
- GA2
- GA3 GB
- GA3 GD
- GA3 GF
- LLL
- LLA
- LLM
- LLR
- NFM
- GJ4
- ZRA
- ZRB
- KRM
- KR3
- GMA
- GMD
- ⚠Caution /Notice

Part number # indicates the package specification code.

GQM Series Temperature Compensating Type High Q Part Number List

(→ 2.0×1.25mm)

Rated Voltage	TC Code	Cap.	Tol.	Part Number
250Vdc	X8G	75pF	±2%	GQM2195G2E750GB12#
			±5%	GQM2195G2E750JB12#
		82pF	±1%	GQM2195G2E820FB12#
			±2%	GQM2195G2E820GB12#
			±5%	GQM2195G2E820JB12#

2.8×2.8mm

Rated Voltage	TC Code	Cap.	Tol.	Part Number
500Vdc	COG	0.30pF	±0.05pF	GQM22M5C2HR30WB01#
			±0.1pF	GQM22M5C2HR30BB01#
			±0.25pF	GQM22M5C2HR30CB01#
		0.40pF	±0.05pF	GQM22M5C2HR40WB01#
			±0.1pF	GQM22M5C2HR40BB01#
			±0.25pF	GQM22M5C2HR40CB01#
		0.50pF	±0.05pF	GQM22M5C2HR50WB01#
			±0.1pF	GQM22M5C2HR50BB01#
			±0.25pF	GQM22M5C2HR50CB01#
		0.60pF	±0.05pF	GQM22M5C2HR60WB01#
			±0.1pF	GQM22M5C2HR60BB01#
			±0.25pF	GQM22M5C2HR60CB01#
		0.70pF	±0.05pF	GQM22M5C2HR70WB01#
			±0.1pF	GQM22M5C2HR70BB01#
			±0.25pF	GQM22M5C2HR70CB01#
		0.75pF	±0.05pF	GQM22M5C2HR75WB01#
			±0.1pF	GQM22M5C2HR75BB01#
			±0.25pF	GQM22M5C2HR75CB01#
		0.80pF	±0.05pF	GQM22M5C2HR80WB01#
			±0.1pF	GQM22M5C2HR80BB01#
			±0.25pF	GQM22M5C2HR80CB01#
		0.90pF	±0.05pF	GQM22M5C2HR90WB01#
			±0.1pF	GQM22M5C2HR90BB01#
			±0.25pF	GQM22M5C2HR90CB01#
		1.0pF	±0.05pF	GQM22M5C2H1R0WB01#
			±0.1pF	GQM22M5C2H1R0BB01#
			±0.25pF	GQM22M5C2H1R0CB01#
			±0.5pF	GQM22M5C2H1R0DB01#
		1.1pF	±0.05pF	GQM22M5C2H1R1WB01#
			±0.1pF	GQM22M5C2H1R1BB01#
			±0.25pF	GQM22M5C2H1R1CB01#
			±0.5pF	GQM22M5C2H1R1DB01#
		1.2pF	±0.05pF	GQM22M5C2H1R2WB01#
			±0.1pF	GQM22M5C2H1R2BB01#
			±0.25pF	GQM22M5C2H1R2CB01#
			±0.5pF	GQM22M5C2H1R2DB01#
		1.3pF	±0.05pF	GQM22M5C2H1R3WB01#
			±0.1pF	GQM22M5C2H1R3BB01#
			±0.25pF	GQM22M5C2H1R3CB01#
			±0.5pF	GQM22M5C2H1R3DB01#
		1.4pF	±0.05pF	GQM22M5C2H1R4WB01#
			±0.1pF	GQM22M5C2H1R4BB01#
			±0.25pF	GQM22M5C2H1R4CB01#
			±0.5pF	GQM22M5C2H1R4DB01#

Rated Voltage	TC Code	Cap.	Tol.	Part Number
500Vdc	COG	1.5pF	±0.05pF	GQM22M5C2H1R5WB01#
			±0.1pF	GQM22M5C2H1R5BB01#
			±0.25pF	GQM22M5C2H1R5CB01#
			±0.5pF	GQM22M5C2H1R5DB01#
			±0.5pF	GQM22M5C2H1R5DB01#
		1.6pF	±0.05pF	GQM22M5C2H1R6WB01#
			±0.1pF	GQM22M5C2H1R6BB01#
			±0.25pF	GQM22M5C2H1R6CB01#
			±0.5pF	GQM22M5C2H1R6DB01#
			±0.5pF	GQM22M5C2H1R6DB01#
		1.7pF	±0.05pF	GQM22M5C2H1R7WB01#
			±0.1pF	GQM22M5C2H1R7BB01#
			±0.25pF	GQM22M5C2H1R7CB01#
		1.8pF	±0.05pF	GQM22M5C2H1R8WB01#
			±0.1pF	GQM22M5C2H1R8BB01#
			±0.25pF	GQM22M5C2H1R8CB01#
		1.9pF	±0.05pF	GQM22M5C2H1R9WB01#
			±0.1pF	GQM22M5C2H1R9BB01#
			±0.25pF	GQM22M5C2H1R9CB01#
		2.0pF	±0.05pF	GQM22M5C2H2R0WB01#
			±0.1pF	GQM22M5C2H2R0BB01#
			±0.25pF	GQM22M5C2H2R0CB01#
		2.1pF	±0.05pF	GQM22M5C2H2R1WB01#
			±0.1pF	GQM22M5C2H2R1BB01#
			±0.25pF	GQM22M5C2H2R1CB01#
		2.2pF	±0.05pF	GQM22M5C2H2R2WB01#
			±0.1pF	GQM22M5C2H2R2BB01#
			±0.25pF	GQM22M5C2H2R2CB01#
		2.3pF	±0.05pF	GQM22M5C2H2R3WB01#
			±0.1pF	GQM22M5C2H2R3BB01#
			±0.25pF	GQM22M5C2H2R3CB01#
		2.4pF	±0.05pF	GQM22M5C2H2R4WB01#
			±0.1pF	GQM22M5C2H2R4BB01#
			±0.25pF	GQM22M5C2H2R4CB01#
		2.5pF	±0.05pF	GQM22M5C2H2R5WB01#
			±0.1pF	GQM22M5C2H2R5BB01#
			±0.25pF	GQM22M5C2H2R5CB01#
		2.6pF	±0.05pF	GQM22M5C2H2R6WB01#
			±0.1pF	GQM22M5C2H2R6BB01#
			±0.25pF	GQM22M5C2H2R6CB01#
		2.7pF	±0.05pF	GQM22M5C2H2R7WB01#
			±0.1pF	GQM22M5C2H2R7BB01#
			±0.25pF	GQM22M5C2H2R7CB01#
		2.8pF	±0.05pF	GQM22M5C2H2R8WB01#
			±0.1pF	GQM22M5C2H2R8BB01#

Part number # indicates the package specification code.

- GRM
- GR3
- GRJ
- GR4
- GJM
- GQM
- GA2
- GA3 GB
- GA3 GD
- GA3 GF
- LLL
- LLA
- LLM
- LLR
- NFM
- GJ4
- ZRA
- ZRB
- KRM
- KR3
- GMA
- GMD
- ⚠Caution /Notice

GQM Series Temperature Compensating Type High Q Part Number List

(→ 2.8×2.8mm)

Rated Voltage	TC Code	Cap.	Tol.	Part Number	Rated Voltage	TC Code	Cap.	Tol.	Part Number
500Vdc	COG	2.8pF	±0.25pF	GQM22M5C2H2R8CB01#	500Vdc	COG	4.2pF	±0.05pF	GQM22M5C2H4R2WB01#
			±0.5pF	GQM22M5C2H2R8DB01#				±0.1pF	GQM22M5C2H4R2BB01#
		2.9pF	±0.05pF	GQM22M5C2H2R9WB01#			±0.25pF	GQM22M5C2H4R2CB01#	
			±0.1pF	GQM22M5C2H2R9BB01#			±0.5pF	GQM22M5C2H4R2DB01#	
			±0.25pF	GQM22M5C2H2R9CB01#			4.3pF	±0.05pF	GQM22M5C2H4R3WB01#
			±0.5pF	GQM22M5C2H2R9DB01#				±0.1pF	GQM22M5C2H4R3BB01#
		3.0pF	±0.05pF	GQM22M5C2H3R0WB01#			±0.25pF	GQM22M5C2H4R3CB01#	
			±0.1pF	GQM22M5C2H3R0BB01#			±0.5pF	GQM22M5C2H4R3DB01#	
			±0.25pF	GQM22M5C2H3R0CB01#			4.4pF	±0.05pF	GQM22M5C2H4R4WB01#
			±0.5pF	GQM22M5C2H3R0DB01#				±0.1pF	GQM22M5C2H4R4BB01#
		3.1pF	±0.05pF	GQM22M5C2H3R1WB01#			±0.25pF	GQM22M5C2H4R4CB01#	
			±0.1pF	GQM22M5C2H3R1BB01#			±0.5pF	GQM22M5C2H4R4DB01#	
			±0.25pF	GQM22M5C2H3R1CB01#			4.5pF	±0.05pF	GQM22M5C2H4R5WB01#
			±0.5pF	GQM22M5C2H3R1DB01#				±0.1pF	GQM22M5C2H4R5BB01#
		3.2pF	±0.05pF	GQM22M5C2H3R2WB01#			±0.25pF	GQM22M5C2H4R5CB01#	
			±0.1pF	GQM22M5C2H3R2BB01#			±0.5pF	GQM22M5C2H4R5DB01#	
			±0.25pF	GQM22M5C2H3R2CB01#			4.6pF	±0.05pF	GQM22M5C2H4R6WB01#
			±0.5pF	GQM22M5C2H3R2DB01#				±0.1pF	GQM22M5C2H4R6BB01#
		3.3pF	±0.05pF	GQM22M5C2H3R3WB01#			±0.25pF	GQM22M5C2H4R6CB01#	
			±0.1pF	GQM22M5C2H3R3BB01#			±0.5pF	GQM22M5C2H4R6DB01#	
			±0.25pF	GQM22M5C2H3R3CB01#			4.7pF	±0.05pF	GQM22M5C2H4R7WB01#
			±0.5pF	GQM22M5C2H3R3DB01#				±0.1pF	GQM22M5C2H4R7BB01#
		3.4pF	±0.05pF	GQM22M5C2H3R4WB01#			±0.25pF	GQM22M5C2H4R7CB01#	
			±0.1pF	GQM22M5C2H3R4BB01#			±0.5pF	GQM22M5C2H4R7DB01#	
			±0.25pF	GQM22M5C2H3R4CB01#			4.8pF	±0.05pF	GQM22M5C2H4R8WB01#
			±0.5pF	GQM22M5C2H3R4DB01#				±0.1pF	GQM22M5C2H4R8BB01#
		3.5pF	±0.05pF	GQM22M5C2H3R5WB01#			±0.25pF	GQM22M5C2H4R8CB01#	
			±0.1pF	GQM22M5C2H3R5BB01#			±0.5pF	GQM22M5C2H4R8DB01#	
			±0.25pF	GQM22M5C2H3R5CB01#			4.9pF	±0.05pF	GQM22M5C2H4R9WB01#
			±0.5pF	GQM22M5C2H3R5DB01#				±0.1pF	GQM22M5C2H4R9BB01#
		3.6pF	±0.05pF	GQM22M5C2H3R6WB01#			±0.25pF	GQM22M5C2H4R9CB01#	
			±0.1pF	GQM22M5C2H3R6BB01#			±0.5pF	GQM22M5C2H4R9DB01#	
			±0.25pF	GQM22M5C2H3R6CB01#			5.0pF	±0.05pF	GQM22M5C2H5R0WB01#
			±0.5pF	GQM22M5C2H3R6DB01#				±0.1pF	GQM22M5C2H5R0BB01#
		3.7pF	±0.05pF	GQM22M5C2H3R7WB01#			±0.25pF	GQM22M5C2H5R0CB01#	
			±0.1pF	GQM22M5C2H3R7BB01#			±0.5pF	GQM22M5C2H5R0DB01#	
			±0.25pF	GQM22M5C2H3R7CB01#			5.1pF	±0.05pF	GQM22M5C2H5R1WB01#
			±0.5pF	GQM22M5C2H3R7DB01#				±0.1pF	GQM22M5C2H5R1BB01#
		3.8pF	±0.05pF	GQM22M5C2H3R8WB01#			±0.25pF	GQM22M5C2H5R1CB01#	
			±0.1pF	GQM22M5C2H3R8BB01#			±0.5pF	GQM22M5C2H5R1DB01#	
			±0.25pF	GQM22M5C2H3R8CB01#			5.2pF	±0.05pF	GQM22M5C2H5R2WB01#
			±0.5pF	GQM22M5C2H3R8DB01#				±0.1pF	GQM22M5C2H5R2BB01#
		3.9pF	±0.05pF	GQM22M5C2H3R9WB01#			±0.25pF	GQM22M5C2H5R2CB01#	
			±0.1pF	GQM22M5C2H3R9BB01#			±0.5pF	GQM22M5C2H5R2DB01#	
			±0.25pF	GQM22M5C2H3R9CB01#			5.3pF	±0.05pF	GQM22M5C2H5R3WB01#
			±0.5pF	GQM22M5C2H3R9DB01#				±0.1pF	GQM22M5C2H5R3BB01#
		4.0pF	±0.05pF	GQM22M5C2H4R0WB01#			±0.25pF	GQM22M5C2H5R3CB01#	
			±0.1pF	GQM22M5C2H4R0BB01#			±0.5pF	GQM22M5C2H5R3DB01#	
±0.25pF	GQM22M5C2H4R0CB01#		5.4pF	±0.05pF	GQM22M5C2H5R4WB01#				
±0.5pF	GQM22M5C2H4R0DB01#			±0.1pF	GQM22M5C2H5R4BB01#				
4.1pF	±0.05pF	GQM22M5C2H4R1WB01#	±0.25pF	GQM22M5C2H5R4CB01#					
	±0.1pF	GQM22M5C2H4R1BB01#	±0.5pF	GQM22M5C2H5R4DB01#					
	±0.25pF	GQM22M5C2H4R1CB01#	5.5pF	±0.05pF	GQM22M5C2H5R5WB01#				
	±0.5pF	GQM22M5C2H4R1DB01#		±0.1pF	GQM22M5C2H5R5BB01#				

Part number # indicates the package specification code.

- GRM
- GR3
- GRJ
- GR4
- GJM
- GQM
- GA2
- GA3 GB
- GA3 GD
- GA3 GF
- LLL
- LLA
- LLM
- LLR
- NFM
- GJ4
- ZRA
- ZRB
- KRM
- KR3
- GMA
- GMD
- ⚠Caution /Notice

GQM Series Temperature Compensating Type High Q Part Number List

(→ 2.8×2.8mm)

Rated Voltage	TC Code	Cap.	Tol.	Part Number	Rated Voltage	TC Code	Cap.	Tol.	Part Number
500Vdc	COG	5.5pF	±0.25pF	GQM22M5C2H5R5CB01#	500Vdc	COG	6.9pF	±0.1pF	GQM22M5C2H6R9BB01#
			±0.5pF	GQM22M5C2H5R5DB01#				±0.25pF	GQM22M5C2H6R9CB01#
		5.6pF	±0.05pF	GQM22M5C2H5R6WB01#			±0.5pF	GQM22M5C2H6R9DB01#	
			±0.1pF	GQM22M5C2H5R6BB01#			7.0pF	±0.1pF	GQM22M5C2H7R0BB01#
			±0.25pF	GQM22M5C2H5R6CB01#				±0.25pF	GQM22M5C2H7R0CB01#
			±0.5pF	GQM22M5C2H5R6DB01#			±0.5pF	GQM22M5C2H7R0DB01#	
		5.7pF	±0.05pF	GQM22M5C2H5R7WB01#			7.1pF	±0.1pF	GQM22M5C2H7R1BB01#
			±0.1pF	GQM22M5C2H5R7BB01#				±0.25pF	GQM22M5C2H7R1CB01#
			±0.25pF	GQM22M5C2H5R7CB01#			±0.5pF	GQM22M5C2H7R1DB01#	
			±0.5pF	GQM22M5C2H5R7DB01#			7.2pF	±0.1pF	GQM22M5C2H7R2BB01#
		5.8pF	±0.05pF	GQM22M5C2H5R8WB01#				±0.25pF	GQM22M5C2H7R2CB01#
			±0.1pF	GQM22M5C2H5R8BB01#			±0.5pF	GQM22M5C2H7R2DB01#	
			±0.25pF	GQM22M5C2H5R8CB01#			7.3pF	±0.1pF	GQM22M5C2H7R3BB01#
			±0.5pF	GQM22M5C2H5R8DB01#				±0.25pF	GQM22M5C2H7R3CB01#
		5.9pF	±0.05pF	GQM22M5C2H5R9WB01#			±0.5pF	GQM22M5C2H7R3DB01#	
			±0.1pF	GQM22M5C2H5R9BB01#			7.4pF	±0.1pF	GQM22M5C2H7R4BB01#
			±0.25pF	GQM22M5C2H5R9CB01#				±0.25pF	GQM22M5C2H7R4CB01#
			±0.5pF	GQM22M5C2H5R9DB01#			±0.5pF	GQM22M5C2H7R4DB01#	
		6.0pF	±0.05pF	GQM22M5C2H6R0WB01#			7.5pF	±0.1pF	GQM22M5C2H7R5BB01#
			±0.1pF	GQM22M5C2H6R0BB01#				±0.25pF	GQM22M5C2H7R5CB01#
			±0.25pF	GQM22M5C2H6R0CB01#			±0.5pF	GQM22M5C2H7R5DB01#	
			±0.5pF	GQM22M5C2H6R0DB01#			7.6pF	±0.1pF	GQM22M5C2H7R6BB01#
		6.1pF	±0.05pF	GQM22M5C2H6R1WB01#				±0.25pF	GQM22M5C2H7R6CB01#
			±0.1pF	GQM22M5C2H6R1BB01#			±0.5pF	GQM22M5C2H7R6DB01#	
			±0.25pF	GQM22M5C2H6R1CB01#			7.7pF	±0.1pF	GQM22M5C2H7R7BB01#
			±0.5pF	GQM22M5C2H6R1DB01#				±0.25pF	GQM22M5C2H7R7CB01#
		6.2pF	±0.05pF	GQM22M5C2H6R2WB01#			±0.5pF	GQM22M5C2H7R7DB01#	
			±0.1pF	GQM22M5C2H6R2BB01#			7.8pF	±0.1pF	GQM22M5C2H7R8BB01#
			±0.25pF	GQM22M5C2H6R2CB01#				±0.25pF	GQM22M5C2H7R8CB01#
			±0.5pF	GQM22M5C2H6R2DB01#			±0.5pF	GQM22M5C2H7R8DB01#	
		6.3pF	±0.05pF	GQM22M5C2H6R3WB01#			7.9pF	±0.1pF	GQM22M5C2H7R9BB01#
			±0.1pF	GQM22M5C2H6R3BB01#				±0.25pF	GQM22M5C2H7R9CB01#
			±0.25pF	GQM22M5C2H6R3CB01#			±0.5pF	GQM22M5C2H7R9DB01#	
			±0.5pF	GQM22M5C2H6R3DB01#			8.0pF	±0.1pF	GQM22M5C2H8R0BB01#
		6.4pF	±0.05pF	GQM22M5C2H6R4WB01#				±0.25pF	GQM22M5C2H8R0CB01#
			±0.1pF	GQM22M5C2H6R4BB01#			±0.5pF	GQM22M5C2H8R0DB01#	
			±0.25pF	GQM22M5C2H6R4CB01#			8.1pF	±0.1pF	GQM22M5C2H8R1BB01#
			±0.5pF	GQM22M5C2H6R4DB01#				±0.25pF	GQM22M5C2H8R1CB01#
		6.5pF	±0.05pF	GQM22M5C2H6R5WB01#			±0.5pF	GQM22M5C2H8R1DB01#	
			±0.1pF	GQM22M5C2H6R5BB01#			8.2pF	±0.1pF	GQM22M5C2H8R2BB01#
			±0.25pF	GQM22M5C2H6R5CB01#				±0.25pF	GQM22M5C2H8R2CB01#
			±0.5pF	GQM22M5C2H6R5DB01#			±0.5pF	GQM22M5C2H8R2DB01#	
		6.6pF	±0.05pF	GQM22M5C2H6R6WB01#			8.3pF	±0.1pF	GQM22M5C2H8R3BB01#
			±0.1pF	GQM22M5C2H6R6BB01#				±0.25pF	GQM22M5C2H8R3CB01#
			±0.25pF	GQM22M5C2H6R6CB01#			±0.5pF	GQM22M5C2H8R3DB01#	
			±0.5pF	GQM22M5C2H6R6DB01#			8.4pF	±0.1pF	GQM22M5C2H8R4BB01#
		6.7pF	±0.05pF	GQM22M5C2H6R7WB01#				±0.25pF	GQM22M5C2H8R4CB01#
			±0.1pF	GQM22M5C2H6R7BB01#			±0.5pF	GQM22M5C2H8R4DB01#	
			±0.25pF	GQM22M5C2H6R7CB01#			8.5pF	±0.1pF	GQM22M5C2H8R5BB01#
			±0.5pF	GQM22M5C2H6R7DB01#				±0.25pF	GQM22M5C2H8R5CB01#
		6.8pF	±0.05pF	GQM22M5C2H6R8WB01#			±0.5pF	GQM22M5C2H8R5DB01#	
			±0.1pF	GQM22M5C2H6R8BB01#			8.6pF	±0.1pF	GQM22M5C2H8R6BB01#
			±0.25pF	GQM22M5C2H6R8CB01#				±0.25pF	GQM22M5C2H8R6CB01#
			±0.5pF	GQM22M5C2H6R8DB01#			±0.5pF	GQM22M5C2H8R6DB01#	

- GRM
- GR3
- GRJ
- GR4
- GJM
- GQM**
- GA2
- GA3 GB
- GA3 GD
- GA3 GF
- LLL
- LLA
- LLM
- LLR
- NFM
- GJ4
- ZRA
- ZRB
- KRM
- KR3
- GMA
- GMD
- ⚠Caution /Notice

Part number # indicates the package specification code.

GQM Series Temperature Compensating Type High Q Part Number List

(→ 2.8×2.8mm)

Rated Voltage	TC Code	Cap.	Tol.	Part Number	Rated Voltage	TC Code	Cap.	Tol.	Part Number	
500Vdc	COG	8.7pF	±0.1pF	GQM22M5C2H8R7BB01#	500Vdc	COG	14pF	±5%	GQM22M5C2H140JB01#	
			±0.25pF	GQM22M5C2H8R7CB01#				15pF	±1%	GQM22M5C2H150FB01#
			±0.5pF	GQM22M5C2H8R7DB01#					±2%	GQM22M5C2H150GB01#
		8.8pF	±0.1pF	GQM22M5C2H8R8BB01#			16pF	±5%	GQM22M5C2H150JB01#	
			±0.25pF	GQM22M5C2H8R8CB01#				±1%	GQM22M5C2H160FB01#	
			±0.5pF	GQM22M5C2H8R8DB01#			±2%	GQM22M5C2H160GB01#		
		8.9pF	±0.1pF	GQM22M5C2H8R9BB01#			18pF	±5%	GQM22M5C2H160JB01#	
			±0.25pF	GQM22M5C2H8R9CB01#				±1%	GQM22M5C2H180FB01#	
			±0.5pF	GQM22M5C2H8R9DB01#			±2%	GQM22M5C2H180GB01#		
		9.0pF	±0.1pF	GQM22M5C2H9R0BB01#			20pF	±5%	GQM22M5C2H180JB01#	
			±0.25pF	GQM22M5C2H9R0CB01#				±1%	GQM22M5C2H200FB01#	
			±0.5pF	GQM22M5C2H9R0DB01#			±2%	GQM22M5C2H200GB01#		
		9.1pF	±0.1pF	GQM22M5C2H9R1BB01#			22pF	±5%	GQM22M5C2H200JB01#	
			±0.25pF	GQM22M5C2H9R1CB01#				±1%	GQM22M5C2H220FB01#	
			±0.5pF	GQM22M5C2H9R1DB01#			±2%	GQM22M5C2H220GB01#		
		9.2pF	±0.1pF	GQM22M5C2H9R2BB01#			24pF	±5%	GQM22M5C2H220JB01#	
			±0.25pF	GQM22M5C2H9R2CB01#				±1%	GQM22M5C2H240FB01#	
			±0.5pF	GQM22M5C2H9R2DB01#			±2%	GQM22M5C2H240GB01#		
		9.3pF	±0.1pF	GQM22M5C2H9R3BB01#			25pF	±5%	GQM22M5C2H240JB01#	
			±0.25pF	GQM22M5C2H9R3CB01#				±1%	GQM22M5C2H250FB01#	
			±0.5pF	GQM22M5C2H9R3DB01#			±2%	GQM22M5C2H250GB01#		
		9.4pF	±0.1pF	GQM22M5C2H9R4BB01#			27pF	±5%	GQM22M5C2H250JB01#	
			±0.25pF	GQM22M5C2H9R4CB01#				±1%	GQM22M5C2H270FB01#	
			±0.5pF	GQM22M5C2H9R4DB01#			±2%	GQM22M5C2H270GB01#		
		9.5pF	±0.1pF	GQM22M5C2H9R5BB01#			28pF	±5%	GQM22M5C2H270JB01#	
			±0.25pF	GQM22M5C2H9R5CB01#				±1%	GQM22M5C2H280FB01#	
			±0.5pF	GQM22M5C2H9R5DB01#			±2%	GQM22M5C2H280GB01#		
		9.6pF	±0.1pF	GQM22M5C2H9R6BB01#			30pF	±5%	GQM22M5C2H280JB01#	
			±0.25pF	GQM22M5C2H9R6CB01#				±1%	GQM22M5C2H300FB01#	
			±0.5pF	GQM22M5C2H9R6DB01#			±2%	GQM22M5C2H300GB01#		
		9.7pF	±0.1pF	GQM22M5C2H9R7BB01#			32pF	±5%	GQM22M5C2H300JB01#	
			±0.25pF	GQM22M5C2H9R7CB01#				±1%	GQM22M5C2H320FB01#	
			±0.5pF	GQM22M5C2H9R7DB01#			±2%	GQM22M5C2H320GB01#		
		9.8pF	±0.1pF	GQM22M5C2H9R8BB01#			33pF	±5%	GQM22M5C2H320JB01#	
			±0.25pF	GQM22M5C2H9R8CB01#				±1%	GQM22M5C2H330FB01#	
			±0.5pF	GQM22M5C2H9R8DB01#			±2%	GQM22M5C2H330GB01#		
		9.9pF	±0.1pF	GQM22M5C2H9R9BB01#			34pF	±5%	GQM22M5C2H330JB01#	
			±0.25pF	GQM22M5C2H9R9CB01#				±1%	GQM22M5C2H340FB01#	
			±0.5pF	GQM22M5C2H9R9DB01#			±2%	GQM22M5C2H340GB01#		
		10pF	±1%	GQM22M5C2H100FB01#			36pF	±5%	GQM22M5C2H340JB01#	
			±2%	GQM22M5C2H100GB01#				±1%	GQM22M5C2H360FB01#	
			±2.5%	GQM22M5C2H100RB01#				±2%	GQM22M5C2H360GB01#	
			±5%	GQM22M5C2H100JB01#				±5%	GQM22M5C2H360JB01#	
		11pF	±1%	GQM22M5C2H110FB01#			39pF	±1%	GQM22M5C2H390FB01#	
			±2%	GQM22M5C2H110GB01#				±2%	GQM22M5C2H390GB01#	
			±5%	GQM22M5C2H110JB01#				±5%	GQM22M5C2H390JB01#	
		12pF	±1%	GQM22M5C2H120FB01#			43pF	±1%	GQM22M5C2H430FB01#	
			±2%	GQM22M5C2H120GB01#				±2%	GQM22M5C2H430GB01#	
			±5%	GQM22M5C2H120JB01#				±5%	GQM22M5C2H430JB01#	
		13pF	±1%	GQM22M5C2H130FB01#			47pF	±1%	GQM22M5C2H470FB01#	
			±2%	GQM22M5C2H130GB01#				±2%	GQM22M5C2H470GB01#	
			±5%	GQM22M5C2H130JB01#				±5%	GQM22M5C2H470JB01#	
		14pF	±1%	GQM22M5C2H140FB01#			51pF	±1%	GQM22M5C2H510FB01#	
			±2%	GQM22M5C2H140GB01#				±2%	GQM22M5C2H510GB01#	

- GRM
- GR3
- GRJ
- GR4
- GJM
- GQM**
- GA2
- GA3 GB
- GA3 GD
- GA3 GF
- LLL
- LLA
- LLM
- LLR
- NFM
- GJ4
- ZRA
- ZRB
- KRM
- KR3
- GMA
- GMD
- ⚠Caution /Notice

Part number # indicates the package specification code.

GQM Series Temperature Compensating Type **High Q** Part Number List

(→ 2.8×2.8mm)

Rated Voltage	TC Code	Cap.	Tol.	Part Number	
500Vdc	COG	51pF	±5%	GQM22M5C2H510JB01#	
			±1%	GQM22M5C2H560FB01#	
				±2%	GQM22M5C2H560GB01#
		±5%		GQM22M5C2H560JB01#	
		62pF	±1%	GQM22M5C2H620FB01#	
			±2%	GQM22M5C2H620GB01#	
			±5%	GQM22M5C2H620JB01#	
		68pF	±1%	GQM22M5C2H680FB01#	
			±2%	GQM22M5C2H680GB01#	
			±5%	GQM22M5C2H680JB01#	
		75pF	±1%	GQM22M5C2H750FB01#	
			±2%	GQM22M5C2H750GB01#	
			±5%	GQM22M5C2H750JB01#	
		82pF	±1%	GQM22M5C2H820FB01#	
			±2%	GQM22M5C2H820GB01#	
			±5%	GQM22M5C2H820JB01#	
		91pF	±1%	GQM22M5C2H910FB01#	
			±2%	GQM22M5C2H910GB01#	
			±5%	GQM22M5C2H910JB01#	
		100pF	±1%	GQM22M5C2H101FB01#	
			±2%	GQM22M5C2H101GB01#	
			±5%	GQM22M5C2H101JB01#	

- GRM
- GR3
- GRJ
- GR4
- GJM
- GQM**
- GA2
- GA3 GB
- GA3 GD
- GA3 GF
- LLL
- LLA
- LLM
- LLR
- NFM
- GJ4
- ZRA
- ZRB
- KRM
- KR3
- GMA
- GMD
- ⚠Caution /Notice

Part number # indicates the package specification code.

Based on the Electrical Appliance and Material Safety Law of Japan Chip Multilayer Ceramic Capacitors for General Purpose

GA2 Series



This product is for commercial power supplies, compliant with the Electrical Appliance and Material Safety Law of Japan.

Features

- ① Sn plating is applied to the external electrodes, providing excellent solderability.

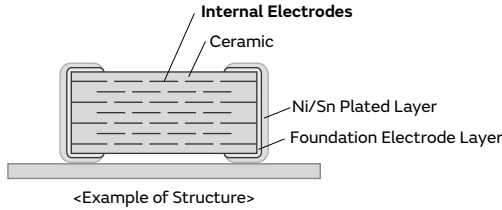

- ② Realized large capacitance value and small size while maintaining high withstand voltages by the multilayer structure.
- ③ This product is only for reflow soldering.
- ④ There are types for connections between lines and connections between lines and ground.

Specifications

Size (mm)	4.5×2.0mm to 5.7×5.0mm
Rated Voltage	250Vac(r.m.s.)
Capacitance	470pF to 0.10μF
Main Applications	General purpose for Japan

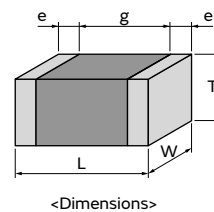

This catalog contains only a portion of the product lineup.
 Please refer to the capacitor search tool on the Murata Web site for details.

- GRM
- GR3
- GRJ
- GR4
- GJM
- GQM
- GA2**
- GA3 GB
- GA3 GD
- GA3 GF
- LLL
- LLA
- LLM
- LLR
- NFM
- GJ4
- ZRA
- ZRB
- KPM
- KR3
- GMA
- GMD
- ⚠Caution /Notice

GA2 Series High Dielectric Constant Type Part Number List

4.5×2.0mm

Rated Voltage	TC Code	Cap.	Tol.	Part Number	
250Vac(r.m.s.)	X7R	470pF	±20%	GA242QR7E2471MW01#	
		1000pF	±20%	GA242QR7E2102MW01#	

4.5×3.2mm

Rated Voltage	TC Code	Cap.	Tol.	Part Number	
250Vac(r.m.s.)	X7R	2200pF	±20%	GA243QR7E2222MW01#	
		3300pF	±20%	GA243QR7E2332MW01#	
		4700pF	±20%	GA243DR7E2472MW01#	
		10000pF	±20%	GA243QR7E2103MW01#	
		22000pF	±20%	GA243QR7E2223MW01#	
		47000pF	±20%	GA243DR7E2473MW01#	

5.7×5.0mm

Rated Voltage	TC Code	Cap.	Tol.	Part Number	
250Vac(r.m.s.)	X7R	0.10μF	±20%	GA255DR7E2104MW01#	

- GRM
- GR3
- GRJ
- GR4
- GJM
- GQM
- GA2**
- GA3 GB
- GA3 GD
- GA3 GF
- LLL
- LLA
- LLM
- LLR
- NFM
- GJ4
- ZRA
- ZRB
- KRM
- KR3
- GMA
- GMD
- ⚠Caution /Notice

Part number # indicates the package specification code.

Safety Standard Certified Chip Multilayer Ceramic Capacitors for General Purpose / IEC60384-14 Class X2

GA3 Series Type GB



IEC60384-14 Class X2 Certified Product

Features

① IEC60384-14 Class X2 Certified product.

Please down load Safety Standard Certification (Type GB: X2) from here.



② Can be used as a Class X2 capacitor.

● Switching Power Supply - Class 1 Equipment

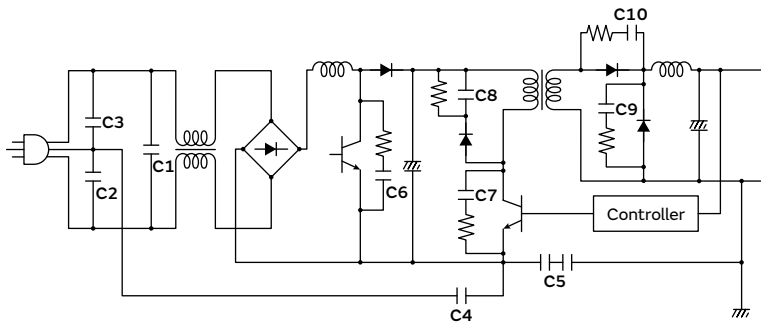

No.	Application	Recommend MLCC Type
C1	X Cap	Type: GB
C2	Y Cap	Type: GF
C3		
C4		
C5	Primary - Secondary Coupling	Type: GF×2

● Switching Power Supply - Class 2 Equipment

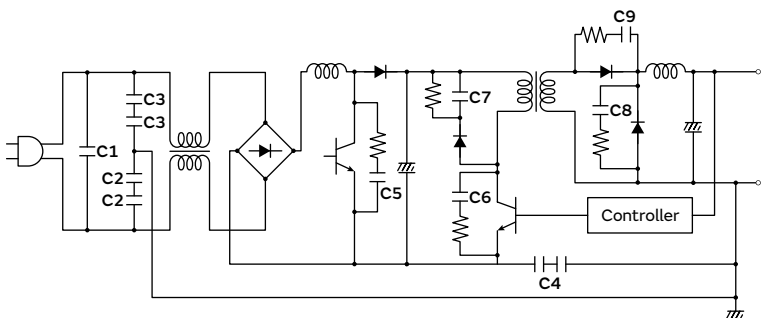

No.	Application	Recommend MLCC Type
C1	X Cap	Type: GB
C2	Y Cap	Type: GF×2
C3		
C4	Primary - Secondary Coupling	

- GRM
- GR3
- GRJ
- GR4
- GJM
- GQM
- GA2
- GA3 GB
- GA3 GD
- GA3 GF
- LLL
- LLA
- LLM
- LLR
- NFM
- GJ4
- ZRA
- ZRB
- KPM
- KR3
- GMA
- GMD
- △Caution /Notice

- ③ Realized large capacitance value and small size while maintaining high withstand voltages by the multilayer structure.

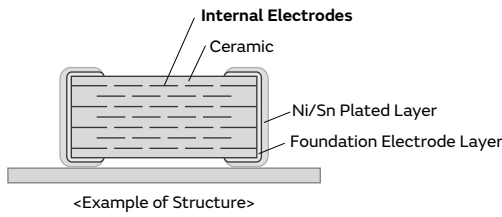

- ④ Compared with conventional lead type capacitors, this product realized great reductions in size and height, with a volume of 1/10 or less, and height of 1/4 or less.
- ⑤ This product is only for reflow soldering.

Specifications

Size (mm)	5.7×5.0mm
Rated Voltage	250Vac(r.m.s.)
Capacitance	10000pF to 56000pF
Main Applications	AC-DC power supply

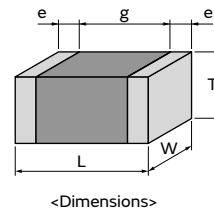

This catalog contains only a portion of the product lineup.
 Please refer to the capacitor search tool on the Murata Web site for details.

- GRM
- GR3
- GRJ
- GR4
- GJM
- GQM
- GA2
- GA3 GB
- GA3 GD
- GA3 GF
- LLL
- LLA
- LLM
- LLR
- NFM
- GJ4
- ZRA
- ZRB
- KPM
- KR3
- GMA
- GMD
- ⚠Caution /Notice

GA3 Series Type GB High Dielectric Constant Type Part Number List

5.7×5.0mm

Rated Voltage	TC Code	Cap.	Tol.	Part Number	
250Vac(r.m.s.)	X7R	10000pF	±10%	GA355QR7GB103KW01#	
		15000pF	±10%	GA355QR7GB153KW01#	
		22000pF	±10%	GA355DR7GB223KW01#	
		33000pF	±10%	GA355ER7GB333KW01#	
		47000pF	±10%	GA355ER7GB473KW01#	
		56000pF	±10%	GA355XR7GB563KW06#	

GRM

GR3

GRJ

GR4

GJM

GQM

GA2

GA3 GB

GA3 GD

GA3 GF

LLL

LLA

LLM

LLR

NFM

GJ4

ZRA

ZRB

KPM

KR3

GMA

GMD

⚠Caution /Notice

Part number # indicates the package specification code.

Safety Standard Certified Chip Multilayer Ceramic Capacitors for General Purpose / Acquired certifications of UL60950-1

GA3 Series Type GD



UL60950-1 Certified Product

Features

- 1 **UL60950-1 certified product.**

Please download Safety Standard Certification (Type GD) from here.



- 2 **Can be used for UL60950-1 devices.**

● DAA Modem - Transformer Less

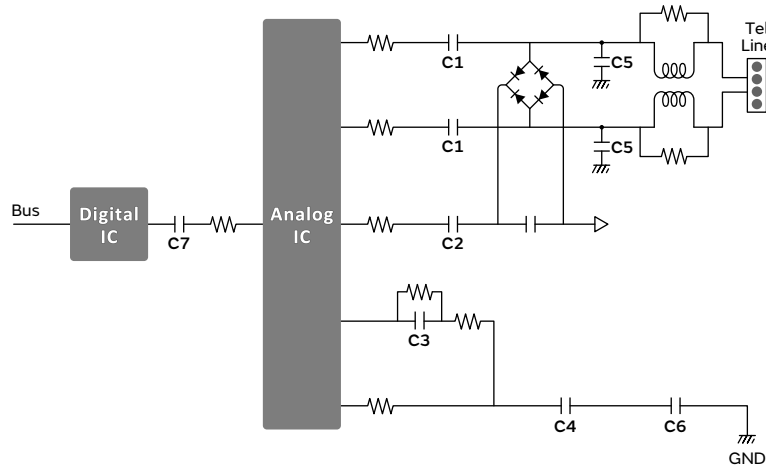

No.	Application	Recommend MLCC Type
C5	Lighting Surge Absorption	Type: GD / GF
C6	Noise Immunity	
C7	D/A Isolation Barrier	

- 3 **Realized large capacitance value and small size while maintaining high withstand voltages by the multilayer structure.**

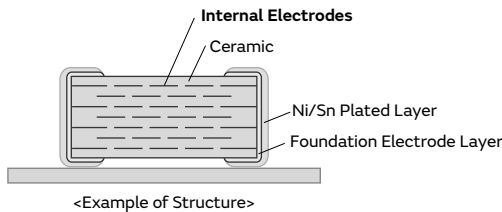

- 4 **This product is only for reflow soldering.**

Specifications

Size (mm)	4.5×2.0mm to 4.5×3.2mm
Rated Voltage	250Vac(r.m.s.)
Capacitance	10pF to 4700pF
Main Applications	Modem

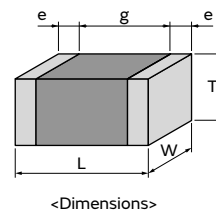

This catalog contains only a portion of the product lineup.
 Please refer to the capacitor search tool on the Murata Web site for details.

GRM
 GR3
 GRJ
 GR4
 GJM
 GQM
 GA2
 GA3 GB
GA3 GD
 GA3 GF
 LLL
 LLA
 LLM
 LLR
 NFM
 GJ4
 ZRA
 ZRB
 KPM
 KR3
 GMA
 GMD
 ⚠Caution / Notice

GA3 Series Type GD Temperature Compensating Type Part Number List

4.5×2.0mm

Rated Voltage	TC Code	Cap.	Tol.	Part Number	
250Vac(r.m.s.)	SL	10pF	±5%	GA342A1XGD100JW31#	
		12pF	±5%	GA342A1XGD120JW31#	
		15pF	±5%	GA342A1XGD150JW31#	
		18pF	±5%	GA342A1XGD180JW31#	
		22pF	±5%	GA342A1XGD220JW31#	
		27pF	±5%	GA342A1XGD270JW31#	
		33pF	±5%	GA342A1XGD330JW31#	
		39pF	±5%	GA342A1XGD390JW31#	
		47pF	±5%	GA342A1XGD470JW31#	
		56pF	±5%	GA342A1XGD560JW31#	
		68pF	±5%	GA342A1XGD680JW31#	
		82pF	±5%	GA342A1XGD820JW31#	

GRM

GR3

GRJ

GR4

GJM

QOM

GA2

GA3
GB

GA3
GD

GA3
GF

LLL

LLA

LLM

LLR

NFM

GJ4

ZRA

ZRB

KPM

KR3

GMA

GMD

⚠Caution
/Notice

Part number # indicates the package specification code.

GA3 Series Type GD High Dielectric Constant Type Part Number List

4.5×2.0mm

Rated Voltage	TC Code	Cap.	Tol.	Part Number	
250Vac(r.m.s.)	X7R	100pF	±10%	GA342QR7GD101KW01#	
		150pF	±10%	GA342QR7GD151KW01#	
		220pF	±10%	GA342QR7GD221KW01#	
		330pF	±10%	GA342QR7GD331KW01#	
		470pF	±10%	GA342QR7GD471KW01#	
		680pF	±10%	GA342QR7GD681KW01#	
		1000pF	±10%	GA342QR7GD102KW01#	
		1500pF	±10%	GA342QR7GD152KW01#	

4.5×3.2mm

Rated Voltage	TC Code	Cap.	Tol.	Part Number	
250Vac(r.m.s.)	X7R	1800pF	±10%	GA343QR7GD182KW01#	
		2200pF	±10%	GA343QR7GD222KW01#	
		4700pF	±10%	GA343DR7GD472KW01#	

GRM

GR3

GRJ

GR4

GJM

QOM

GA2

GA3
GB

GA3
GD

GA3
GF

LLL

LLA

LLM

LLR

NFM

GJ4

ZRA

ZRB

KPM

KR3

GMA

GMD

⚠Caution
/Notice

Safety Standard Certified Chip Multilayer Ceramic Capacitors for General Purpose / Acquired certifications of IEC60384-14 Class X1/Y2 and UL60950-1

GA3 Series Type GF



Size 4.5x2.0mm: This product is applicable only for the instruments certified by EN/IEC60950-1
Size 5.7x2.8mm or 5.7x5.0mm: This product is applicable as X or Y capacitor

Features

① **IEC60384-14 Class X1/X2 certified product.**

Please down load Safety Standard Certification (Type GF: X1/Y2) from here.



② **Can be used as a Class Y2 capacitor.**

● **Switching Power Supply - Class 1 Equipment**

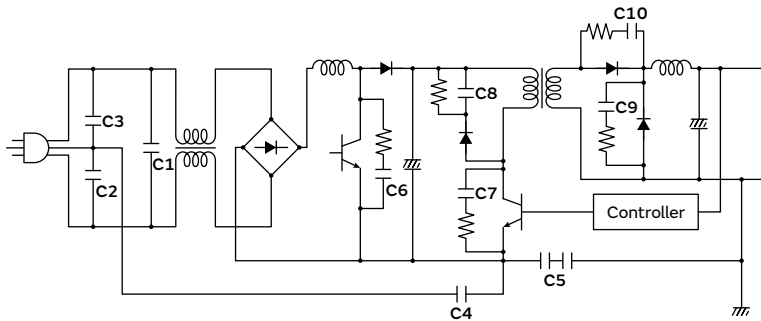

No.	Application	Recommend MLCC Type
C1	X Cap	Type: GB
C2	Y Cap	Type: GF
C3		
C4		
C5	Primary - Secondary Coupling	Type: GF×2

● **Switching Power Supply - Class 2 Equipment**

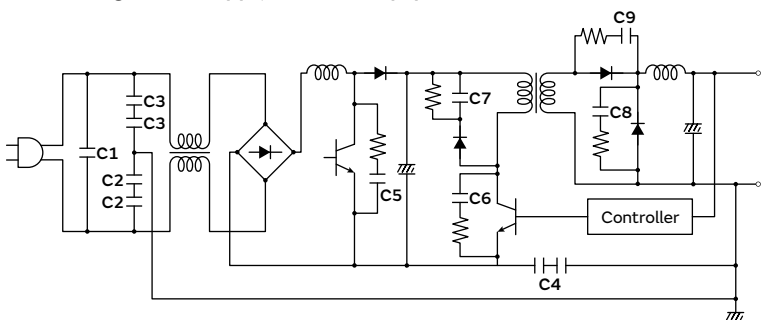

No.	Application	Recommend MLCC Type
C1	X Cap	Type: GB
C2	Y Cap	Type: GF×2
C3		
C4	Primary - Secondary Coupling	

- GRM
- GR3
- GRJ
- GR4
- GJM
- GQM
- GA2
- GA3 GB
- GA3 GD
- GA3 GF
- LLL
- LLA
- LLM
- LLR
- NFM
- GJ4
- ZRA
- ZRB
- KRM
- KR3
- GMA
- GMD
- ⚠Caution /Notice

③ Realized large capacitance value and small size while maintaining high withstand voltages by the multilayer structure.

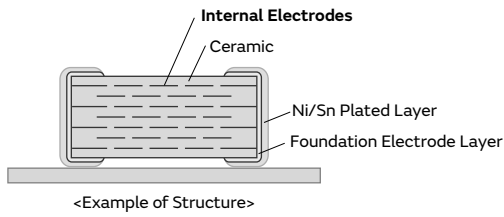

④ This product is only for reflow soldering.

Specifications

Size (mm)	4.5×2.0mm to 5.7×5.0mm
Rated Voltage	250Vac(r.m.s.)
Capacitance	10pF to 4700pF
Main Applications	AC-DC power supply

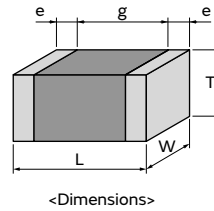

This catalog contains only a portion of the product lineup.
 Please refer to the capacitor search tool on the Murata Web site for details.

- GRM
- GR3
- GRJ
- GR4
- GJM
- GQM
- GA2
- GA3 GB
- GA3 GD
- GA3 GF
- LLL
- LLA
- LLM
- LLR
- NFM
- GJ4
- ZRA
- ZRB
- KPM
- KR3
- GMA
- GMD
- ⚠Caution /Notice

GA3 Series Type GF Temperature Compensating Type Part Number List

4.5×2.0mm

Rated Voltage	TC Code	Cap.	Tol.	Part Number	
250Vac(r.m.s.)	SL	10pF	±5%	GA342A1XGF100JW31#	
		12pF	±5%	GA342A1XGF120JW31#	
		15pF	±5%	GA342A1XGF150JW31#	
		18pF	±5%	GA342A1XGF180JW31#	
		22pF	±5%	GA342A1XGF220JW31#	
		27pF	±5%	GA342A1XGF270JW31#	
		33pF	±5%	GA342A1XGF330JW31#	
		39pF	±5%	GA342A1XGF390JW31#	
		47pF	±5%	GA342A1XGF470JW31#	
		56pF	±5%	GA342A1XGF560JW31#	
		68pF	±5%	GA342A1XGF680JW31#	
		82pF	±5%	GA342A1XGF820JW31#	

GRM

GR3

GRJ

GR4

GJM

QOM

GA2

GA3 GB

GA3 GD

GA3 GF

LLL

LLA

LLM

LLR

NFM

GJ4

ZRA

ZRB

KPM

KR3

GMA

GMD

⚠Caution /Notice

Part number # indicates the package specification code.

GA3 Series Type GF High Dielectric Constant Type Part Number List

4.5×2.0mm

Rated Voltage	TC Code	Cap.	Tol.	Part Number	
250Vac(r.m.s.)	X7R	100pF	±10%	GA342QR7GF101KW01#	
		150pF	±10%	GA342QR7GF151KW01#	
		220pF	±10%	GA342DR7GF221KW02#	
		330pF	±10%	GA342DR7GF331KW02#	
		470pF	±10%	GA342QR7GF471KW01#	
		680pF	±10%	GA342QR7GF681KW01#	
		1000pF	±10%	GA342DR7GF102KW02#	

5.7×2.8mm

Rated Voltage	TC Code	Cap.	Tol.	Part Number	
250Vac(r.m.s.)	X7R	100pF	±10%	GA352QR7GF101KW31#	
		150pF	±10%	GA352QR7GF151KW31#	
		220pF	±10%	GA352QR7GF221KW31#	
		330pF	±10%	GA352QR7GF331KW31#	
		470pF	±10%	GA352QR7GF471KW01#	
		680pF	±10%	GA352QR7GF681KW01#	
		1000pF	±10%	GA352QR7GF102KW01#	
		1500pF	±10%	GA352QR7GF152KW01#	

5.7×5.0mm

Rated Voltage	TC Code	Cap.	Tol.	Part Number	
250Vac(r.m.s.)	X7R	1800pF	±10%	GA355QR7GF182KW01#	
		2200pF	±10%	GA355QR7GF222KW01#	
		3300pF	±10%	GA355QR7GF332KW01#	
		4700pF	±10%	GA355DR7GF472KW01#	

- GRM
- GR3
- GRJ
- GR4
- GJM
- GQM
- GA2
- GA3 GB
- GA3 GD
- GA3 GF
- LLL
- LLA
- LLM
- LLR
- NFM
- GJ4
- ZRA
- ZRB
- KRM
- KR3
- GMA
- GMD
- ⚠Caution /Notice

Part number # indicates the package specification code.

LW Reversed Low ESL Chip Multilayer Ceramic Capacitors for General Purpose

LLL Series



This low ESL capacitor is ideal for power supply decoupling of high-speed operation electronic equipment.

Features

① Low ESL

Since the equivalent series inductance (ESL) is low and excellent in high frequency characteristics, this capacitor is suitable for power supply decoupling of high-speed operation electronic equipment.

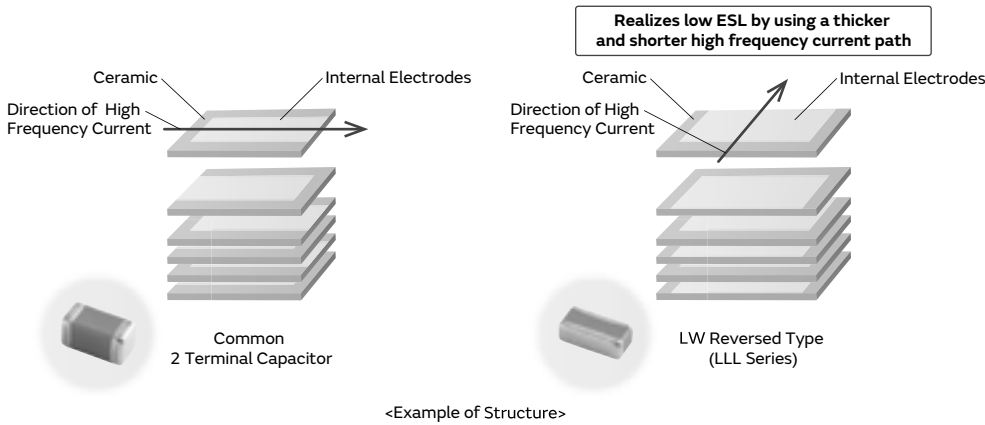

② Contributes to a reduction in the number of components.

The number of components can be reduced by using low ESL capacitors, while maintaining functions equivalent to Common 2 terminal Capacitor.

Murata proposes the use of the LLL series to reduce the number of components and high costs. Simulation is also possible.

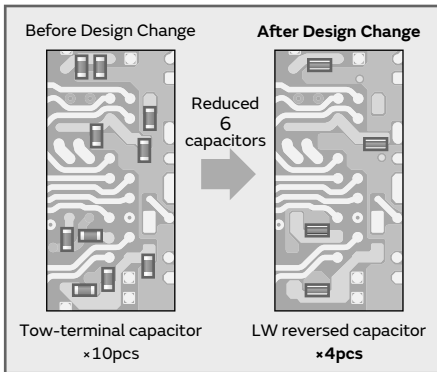

③ A maximum operating temperature up to 125°C

We also offer an abundant lineup of X7* characteristics that can be used in high temperature locations, such as IC packages.

Specifications

Size (mm)	0.5×1.0mm to 1.6×3.2mm
Rated Voltage	2.5Vdc to 50Vdc
Capacitance	2200pF to 10μF
Main Applications	Application processor/CPU/GPU

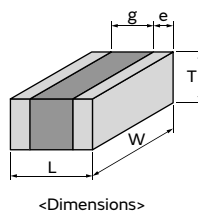

This catalog contains only a portion of the product lineup. Please refer to the capacitor search tool on the Murata Web site for details.

- GRM
- GR3
- GRJ
- GR4
- GJM
- GQM
- GA2
- GA3 GB
- GA3 GD
- GA3 GF
- LLL
- LLA
- LLM
- LLR
- NFM
- GJ4
- ZRA
- ZRB
- KPM
- KR3
- GMA
- GMD
- △Caution /Notice

LLL Series High Dielectric Constant Type Part Number List

0.5×1.0mm

Rated Voltage	TC Code	Cap.	Tol.	Part Number	
10Vdc	X5R	0.10μF	±20%	LLL153R61A104ME01#	
6.3Vdc	X6S	0.10μF	±20%	LLL153C80J104ME01#	
		0.22μF	±20%	LLL153C80J224ME14#	
	X5R	0.10μF	±20%	LLL153R60J104ME01#	
		0.22μF	±20%	LLL153R60J224ME14#	
4Vdc	X7S	0.10μF	±20%	LLL153C70G104ME01#	
		0.47μF	±20%	LLL153C70G474ME17#	
	X7T	0.22μF	±20%	LLL153D70G224ME01#	
		0.10μF	±20%	LLL153C80G104ME01#	
	X6S	0.22μF	±20%	LLL153C80G224ME14#	
		0.47μF	±20%	LLL153C80G474ME17#	
		1.0μF	±20%	LLL153C80G105ME21#	
	X5R	0.10μF	±20%	LLL153R60G104ME01#	
		0.22μF	±20%	LLL153R60G224ME14#	
		0.47μF	±20%	LLL153R60G474ME17#	
2.5Vdc	X7S	0.10μF	±20%	LLL153C70E104ME01#	
		0.47μF	±20%	LLL153C70E474ME17#	
		1.0μF	±20%	LLL153C70E105ME21#	
	X7T	0.22μF	±20%	LLL153D70E224ME01#	

0.6×1.0mm

Rated Voltage	TC Code	Cap.	Tol.	Part Number	
4Vdc	X5R	4.3μF	±20%	LLL1U4R60G435ME22#	D1
2.5Vdc	X6T	4.3μF	±20%	LLL1U4D80E435ME22#	D1

0.8×1.6mm

Rated Voltage	TC Code	Cap.	Tol.	Part Number	
50Vdc	X7R	2200pF	±20%	LLL185R71H222MA01#	
		4700pF	±20%	LLL185R71H472MA01#	
25Vdc	X7R	10000pF	±20%	LLL185R71E103MA01#	
		±20%	LLL185R71E103MA11#		
		22000pF	±20%	LLL185R71E223MA01#	
		±20%	LLL185R71E223MA11#		
16Vdc	X7R	10000pF	±20%	LLL185R71C103MA01#	
		±20%	LLL185R71C103MA11#		
		22000pF	±20%	LLL185R71C223MA01#	
		±20%	LLL185R71C223MA11#		
		47000pF	±20%	LLL185R71C473MA01#	
		±20%	LLL185R71C473MA11#		
10Vdc	X7R	0.10μF	±20%	LLL185R71A104MA01#	
		±20%	LLL185R71A104MA11#		
		0.22μF	±20%	LLL185R71A224MA01#	
6.3Vdc	X7R	0.22μF	±20%	LLL185R70J224MA01#	
		X7S	1.0μF	±20%	LLL185C70J105ME14#
	X5R	0.47μF	±20%	LLL185R60J474MA01#	
		1.0μF	±20%	LLL185R60J105ME14#	
		2.2μF	±20%	LLL185R60J225ME14#	
4Vdc	X7S	0.22μF	±20%	LLL185C70G224MA11#	
		0.47μF	±20%	LLL185C70G474MA01#	

Rated Voltage	TC Code	Cap.	Tol.	Part Number	
4Vdc	X7S	2.2μF	±20%	LLL185C70G225ME01#	
		4.7μF	±20%	LLL185C70G475ME17#	

1.25×2.0mm

Rated Voltage	TC Code	Cap.	Tol.	Part Number	
50Vdc	X7R	10000pF	±20%	LLL215R71H103MA11#	
		±20%	LLL216R71H103MA01#		
		22000pF	±20%	LLL216R71H223MA01#	
25Vdc	X7R	10000pF	±20%	LLL215R71E103MA11#	
		22000pF	±20%	LLL215R71E223MA11#	
		±20%	LLL216R71E223MA01#		
		47000pF	±20%	LLL216R71E473MA01#	
		0.10μF	±20%	LLL216R71E104MA01#	
16Vdc	X7R	22000pF	±20%	LLL215R71C223MA11#	
		47000pF	±20%	LLL215R71C473MA11#	
		±20%	LLL216R71C473MA01#		
		0.10μF	±20%	LLL215R71C104MA11#	
		±20%	LLL216R71C104MA01#		
10Vdc	X7R	0.22μF	±20%	LLL215R71A224MA11#	
		±20%	LLL216R71A224MA01#		
		0.47μF	±20%	LLL219R71A474MA01#	
		1.0μF	±20%	LLL219R71A105MA01#	
		6.3Vdc	X7R	0.47μF	±20%
1.0μF	±20%	LLL219R70J105MA01#			
4Vdc	X7S	1.0μF	±20%	LLL215C70G105MA11#	
		2.2μF	±20%	LLL219C70G225MA01#	

1.6×3.2mm

Rated Voltage	TC Code	Cap.	Tol.	Part Number	
50Vdc	X7R	10000pF	±20%	LLL315R71H103MA11#	
		±20%	LLL317R71H103MA01#		
		22000pF	±20%	LLL315R71H223MA11#	
		±20%	LLL317R71H223MA01#		
		47000pF	±20%	LLL317R71H473MA01#	
		0.10μF	±20%	LLL31MR71H104MA01#	
25Vdc	X7R	22000pF	±20%	LLL315R71E223MA11#	
		±20%	LLL317R71E223MA01#		
		47000pF	±20%	LLL315R71E473MA11#	
		±20%	LLL317R71E473MA01#		
		0.10μF	±20%	LLL315R71E104MA11#	
		±20%	LLL317R71E104MA01#		
16Vdc	X7R	0.22μF	±20%	LLL31MR71E224MA01#	
		0.47μF	±20%	LLL31MR71E474MA01#	
		22000pF	±20%	LLL315R71C223MA11#	
		47000pF	±20%	LLL315R71C473MA11#	
		0.10μF	±20%	LLL315R71C104MA11#	
		±20%	LLL317R71C104MA01#		
4Vdc	X7S	0.22μF	±20%	LLL315R71C224MA11#	
		0.47μF	±20%	LLL315R71C474MA01#	

Part number # indicates the package specification code.

- GRM
- GR3
- GRJ
- GR4
- GJM
- GQM
- GQZ
- GA2
- GA3 GB
- GA3 GD
- GA3 GF
- LLL
- LLA
- LLM
- LLR
- NFM
- GJ4
- ZRA
- ZRB
- KRM
- KR3
- GMA
- GMD
- △Caution /Notice

LLL Series High Dielectric Constant Type Part Number List

(→ 1.6×3.2mm)

Rated Voltage	TC Code	Cap.	Tol.	Part Number	
16Vdc	X7R	0.22μF	±20%	LLL317R71C224MA01#	
		0.47μF	±20%	LLL317R71C474MA01#	
			±20%	LLL31MR71C474MA01#	
		1.0μF	±20%	LLL31MR71C105MA01#	
10Vdc	X7R	0.47μF	±20%	LLL315R71A474MA11#	
			±20%	LLL317R71A474MA01#	
		1.0μF	±20%	LLL317R71A105MA01#	
		2.2μF	±20%	LLL31MR71A225MA01#	
6.3Vdc	X7R	2.2μF	±20%	LLL317R70J225MA01#	
		4.7μF	±20%	LLL31MR70J475MA01#	
	X5R	10μF	±20%	LLL31MR60J106ME01#	

GRM

GR3

GRJ

GR4

GJM

GQM

GA2

GA3
GB

GA3
GD

GA3
GF

LLL

LLA

LLM

LLR

NFM

GJ4

ZRA

ZRB

KRM

KR3

GMA

GMD

⚠Caution
/Notice

8 Terminals Low ESL Chip Multilayer Ceramic Capacitors for General Purpose

LLA Series



8-Terminal Type Low ESL Capacitor Ideal for Power Supply Decoupling of High-speed Operation IC

Features

① Ultra-low ESL

Since the equivalent series inductance (ESL) is very low with excellent high frequency characteristics due to the design structure, this capacitor is ideal for power supply decoupling of high-speed operation IC.

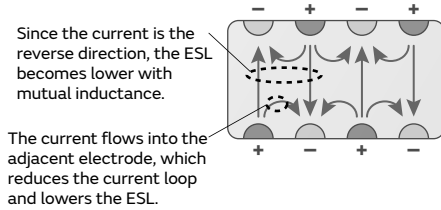
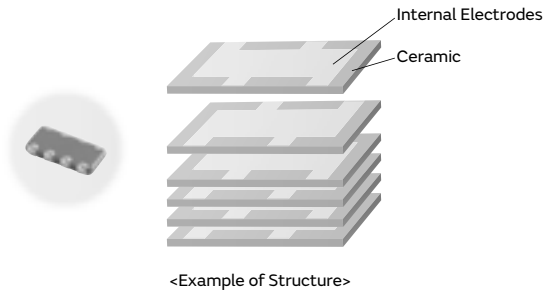

<Effectiveness of Cancelling Out Inductance by Mutual Inductance>

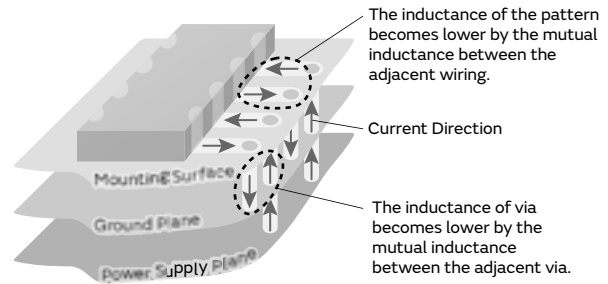

<Effectiveness of Suppressing Inductance when Mounting a Multi-terminal Capacitor>

The inductance for the boards also becomes lower, not only the capacitor.

② A maximum operating temperature up to 125°C

This product is applicable to high temperatures (X7* characteristics); however, Murata also offers numerous thin type products, which are ideal as decoupling capacitors on IC package.

Specifications

Size (mm)	1.6×0.8mm to 2.0×1.25mm
Rated Voltage	4Vdc to 25Vdc
Capacitance	10000pF to 4.7μF
Main Applications	Application processor/CPU/GPU

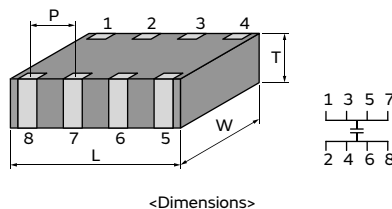

This catalog contains only a portion of the product lineup. Please refer to the capacitor search tool on the Murata Web site for details.

- GRM
- GR3
- GRJ
- GR4
- GJM
- GQM
- GA2
- GA3 GB
- GA3 GD
- GA3 GF
- LLL
- LLA
- LLM
- LLR
- NFM
- GJ4
- ZRA
- ZRB
- KPM
- KR3
- GMA
- GMD
- △Caution / Notice

LLA Series High Dielectric Constant Type Part Number List

1.6×0.8mm

Rated Voltage	TC Code	Cap.	Tol.	Part Number	
4Vdc	X7S	0.10μF	±20%	LLA185C70G104MA01#	
		0.22μF	±20%	LLA185C70G224MA01#	
		0.47μF	±20%	LLA185C70G474MA01#	
		2.2μF	±20%	LLA185C70G225ME16#	

2.0×1.25mm

Rated Voltage	TC Code	Cap.	Tol.	Part Number	
25Vdc	X7R	10000pF	±20%	LLA215R71E103MA14#	
			±20%	LLA219R71E103MA01#	
		22000pF	±20%	LLA215R71E223MA14#	
			±20%	LLA219R71E223MA01#	
16Vdc	X7R	47000pF	±20%	LLA219R71E473MA01#	
		0.10μF	±20%	LLA215R71C104MA14#	
			±20%	LLA219R71C104MA01#	
		0.22μF	±20%	LLA219R71C224MA01#	
10Vdc	X7R	47000pF	±20%	LLA219R71A473MA01#	
		0.10μF	±20%	LLA215R71A104MA14#	
		0.22μF	±20%	LLA215R71A224MA14#	
		0.47μF	±20%	LLA219R71A474MA01#	
6.3Vdc	X7R	0.22μF	±20%	LLA215R70J224MA14#	
		0.47μF	±20%	LLA215R70J474MA14#	
		1.0μF	±20%	LLA219R70J105MA01#	
4Vdc	X5R	1.0μF	±20%	LLA219R60J105MA01#	
		X7R	22000pF	±20%	LLA215R70G223MA14#
	1.0μF		±20%	LLA219R70G105MA01#	
	X7S	1.0μF	±20%	LLA215C70G105MA14#	
		2.2μF	±20%	LLA219C70G225MA01#	
	4.7μF	±20%	LLA215C70G475ME19#		

- GRM
- GR3
- GRJ
- GR4
- GJM
- GQM
- GA2
- GA3 GB
- GA3 GD
- GA3 GF
- LLL
- LLA
- LLM
- LLR
- NFM
- GJ4
- ZRA
- ZRB
- KRM
- KR3
- GMA
- GMD
- ⚠Caution /Notice

10 Terminals Low ESL Chip Multilayer Ceramic Capacitors for General Purpose

LLM Series



10-Terminal Type Low ESL Capacitor Ideal for Power Supply Decoupling of High-speed Operation IC

Features

① This is the lowest ESL LW reversed type capacitor.

Since the equivalent series inductance (ESL) of this product is even lower than the LLA series (8-terminal product) with excellent high frequency characteristics, this capacitor is ideal for power supply decoupling of high-speed operation IC.

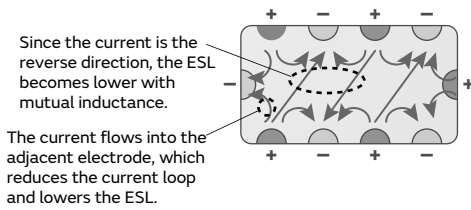
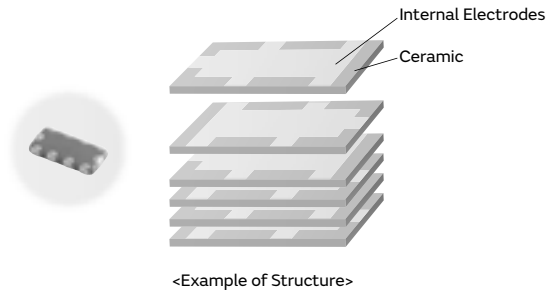

<Effectiveness of Cancelling Out Inductance by Mutual Inductance>

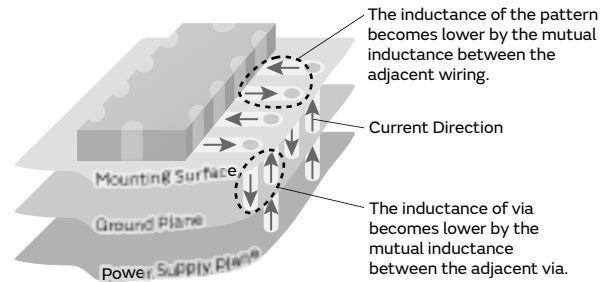

<Effectiveness of Suppressing Inductance when Mounting a Multi-terminal Capacitor>

The inductance for the boards also becomes lower, not only the capacitor.

② A maximum operating temperature up to 125°C

This product is applicable to high temperatures (X7* characteristics); however, Murata also offers numerous thin type products, which are ideal as decoupling capacitors on IC package.

Specifications

Size (mm)	2.0×1.25mm
Rated Voltage	4Vdc to 25Vdc
Capacitance	10000pF to 1.0μF
Main Applications	Application processor/CPU/GPU

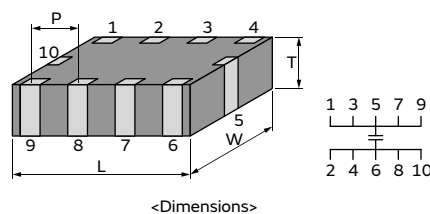

This catalog contains only a portion of the product lineup. Please refer to the capacitor search tool on the Murata Web site for details.

- GRM
- GR3
- GRJ
- GR4
- GJM
- GQM
- GQ2
- GA3 GB
- GA3 GD
- GA3 GF
- LLL
- LLA
- LLM
- LLR
- NFM
- GJ4
- ZRA
- ZRB
- KPM
- KR3
- GMA
- GMD
- △Caution /Notice

LLM Series High Dielectric Constant Type Part Number List

2.0×1.25mm

Rated Voltage	TC Code	Cap.	Tol.	Part Number	
25Vdc	X7R	10000pF	±20%	LLM215R71E103MA11#	
		22000pF	±20%	LLM215R71E223MA11#	
16Vdc	X7R	47000pF	±20%	LLM215R71C473MA11#	
		0.10μF	±20%	LLM215R71C104MA11#	
6.3Vdc	X7R	0.22μF	±20%	LLM215R70J224MA11#	
		0.47μF	±20%	LLM215R70J474MA11#	
4Vdc	X7S	1.0μF	±20%	LLM215C70G105MA11#	

GRM

GR3

GRJ

GR4

GJM

GQM

GA2

GA3
GB

GA3
GD

GA3
GF

LLL

LLA

LLM

LLR

NFM

GJ4

ZRA

ZRB

KPM

KR3

GMA

GMD

⚠Caution
/Notice

LW Reversed Controlled ESR Low ESL Chip Multilayer Ceramic Capacitors for General Purpose

LLR Series



ESR Controlled Type Low ESL Capacitors Equipped with Anti-resonance Control Function

Features

① **Reduces Anti-resonance**

This capacitor is controlled so that the equivalent series resistance (ESR) becomes slightly higher, and is effective in reducing the anti-resonance that occurs when capacitor arrays are used.

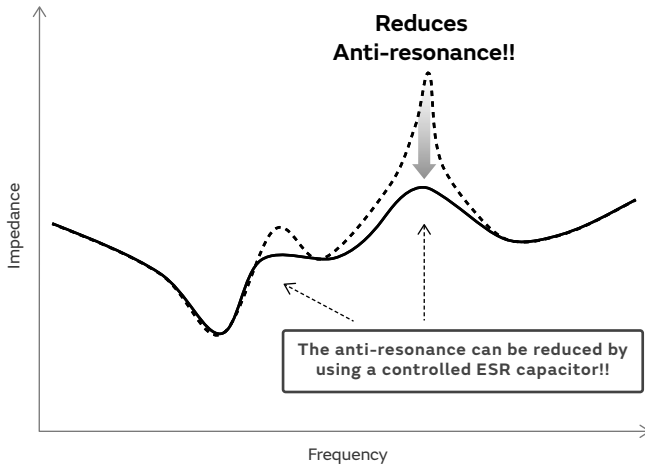

② **Lineup of capacitors with ESR values from 100-1,000mΩ.**

According to the conditions of the anti-resonance, the most suitable ESR value can be selected from 4 types.

③ **Low ESL**

This ESR controlled type capacitor has excellent high frequency characteristics, with low equivalent series inductance (ESL). This is also ideal as a decoupling component.

Specifications

Size (mm)	0.8×1.6mm
Rated Voltage	4Vdc
Capacitance	1.0μF
Main Applications	Network processor/ASIC/PMIC

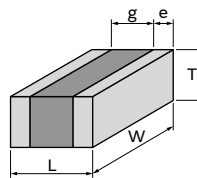

<Dimensions>

This catalog contains only a portion of the product lineup.
 Please refer to the capacitor search tool on the Murata Web site for details.

- GRM
- GR3
- GRJ
- GR4
- GJM
- GQM
- GQ2
- GA3 GB
- GA3 GD
- GA3 GF
- LLL
- LLA
- LLM
- LLR**
- NFM
- GJ4
- ZRA
- ZRB
- KRM
- KR3
- GMA
- GMD
- ⚠Caution /Notice

LLR Series High Dielectric Constant Type Part Number List

0.8×1.6mm

Rated Voltage	TC Code	Cap.	Tol.	Part Number	
4Vdc	X7S	1.0μF	±20%	LLR185C70G105ME01#	
			±20%	LLR185C70G105ME03#	
			±20%	LLR185C70G105ME05#	
			±20%	LLR185C70G105ME07#	

GRM

GR3

GRJ

GR4

GJM

GQM

GA2

GA3
GB

GA3
GD

GA3
GF

LLL

LLA

LLM

LLR

NFM

GJ4

ZRA

ZRB

KPM

KR3



GMA

GMD

⚠Caution
/Notice

Part number # indicates the package specification code.

3 Terminals Low ESL Chip Multilayer Ceramic Capacitors for General Purpose

NFM Series  **Low ESL** **EMI Filter** [WEB](#) 

This is the most suitable Low ESL capacitors for noise measurement and power decoupling of highspeed electrical devices.

Features

① Low ESL

Since the equivalent series inductance (ESL) is low and excellent in high frequency characteristics, this capacitor is suitable for power supply decoupling of high-speed operation electronic equipment.

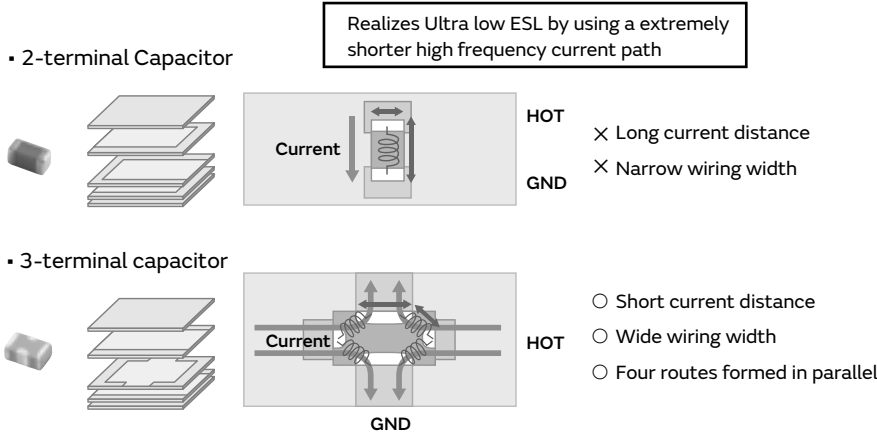

② Contributes to a reduction in the number of components.

The number of components can be reduced by using low ESL capacitors, while maintaining functions equivalent to 2-terminal capacitor.

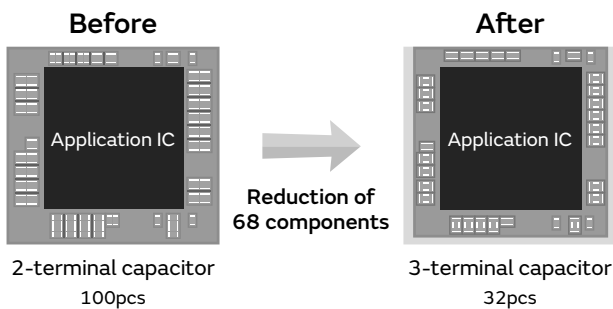

Reference : "How can the mounting area be reduced? —Methods of using low-ESL capacitors—"

[WEB](#) 

- GRM
- GR3
- GRJ
- GR4
- GJM
- GQM
- GA2
- GA3 GB
- GA3 GD
- GA3 GF
- LLL
- LLA
- LLM
- LLR
- NFM
- GJ4
- ZRA
- ZRB
- KPM
- KR3
- GMA
- GMD
- △Caution /Notice

3 Contributes to noise suppression as an EMI filter

Without NFM series

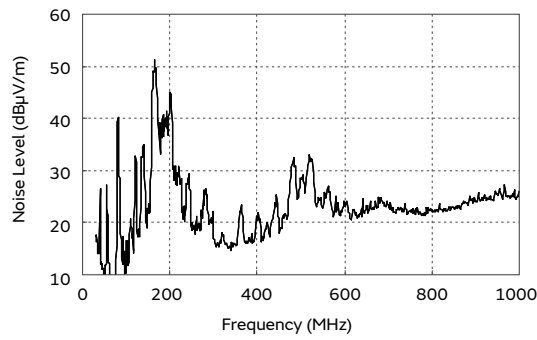
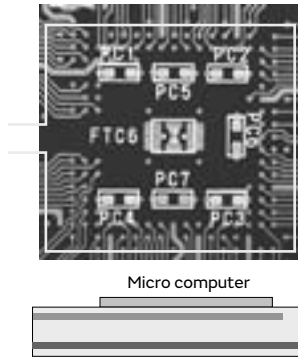

With NFM series 1μF×1pc

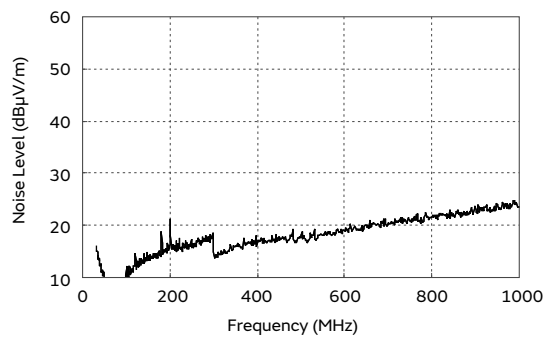
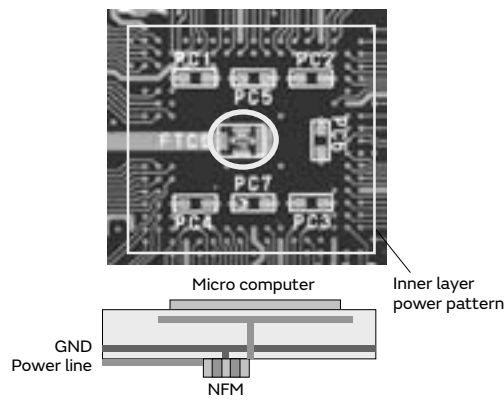

Example of noise suppression effect [WEB](#)

Reference : "Basics of Noise Countermeasures Lesson 11 Notes on the Use of Chip 3-Terminal Capacitors" [WEB](#)

Specifications

Size (mm)	1.0×0.5mm to 4.5×1.6mm
Rated Voltage	2.5Vdc to 100Vdc
Capacitance	100pF to 27μF
Main Applications	Application processor, PMIC

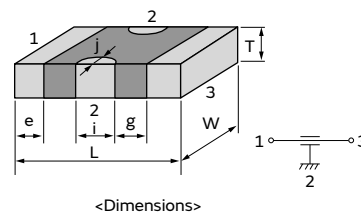

- GRM
- GR3
- GRJ
- GR4
- GJM
- GQM
- GA2
- GA3 GB
- GA3 GD
- GA3 GF
- LLL
- LLA
- LLM
- LLR
- NFM
- GJ4
- ZRA
- ZRB
- KRM
- KR3
- GMA
- GMD
- ⚠Caution /Notice

NFM Series Low ESL EMI Filter Part Number List

1.0×0.5mm

Rated Voltage	Cap.	Tol.	Part Number	
16Vdc	2200pF	±20%	NFM15CC222D1C3#	
	22000pF	±20%	NFM15CC223C1C3#	
	47000pF	±20%	NFM15PC473C1C3#	
10Vdc	2200pF	±20%	NFM15CC222D1A3#	
	22000pF	±20%	NFM15CC223C1A3#	
	47000pF	±20%	NFM15PC473C1A3#	
	0.10μF	±20%	NFM15PC104R1A3#	
6.3Vdc	0.22μF	±20%	NFM15PC224R1A3#	
	0.10μF	±20%	NFM15PC104D0J3#	
	0.22μF	±20%	NFM15PC224D0J3#	
4Vdc	0.47μF	±20%	NFM15PC474R0J3#	
	1.0μF	±20%	NFM15PC105D0J3#	D1
	1.0μF	±20%	NFM15PC105R0J3#	D1
2.5Vdc	4.3μF	±20%	NFM15PC435R0G3#	D1
	7.5μF	±20%	NFM15PC755R0G3#	D1
	9.1μF	±20%	NFM15PC915R0G3#	D1
	14μF	±20%	NFM15PC146R0G3#	Mo D1
	4.3μF	±20%	NFM15PC435D0E3#	D1
	7.5μF	±20%	NFM15PC755D0E3#	D1
4Vdc	0.47μF	±20%	NFM15PC474D0G3#	
	1.0μF	±20%	NFM15PC105D0G3#	D1
2.5Vdc	4.3μF	±20%	NFM15PC435R0E3#	
	7.5μF	±20%	NFM15PC755R0E3#	D1
4Vdc	0.47μF	±20%	NFM15PC474R0G3#	D1
	1.0μF	±20%	NFM15PC105R0G3#	D1
2.5Vdc	4.3μF	±20%	NFM15PC435R0E3#	D1
	7.5μF	±20%	NFM15PC755R0E3#	D1
4Vdc	0.47μF	±20%	NFM15PC474D0G3#	D1
	1.0μF	±20%	NFM15PC105D0G3#	D1
2.5Vdc	4.3μF	±20%	NFM15PC435D0E3#	D1
	7.5μF	±20%	NFM15PC755D0E3#	D1

1.2×0.9mm

Rated Voltage	Cap.	Tol.	Part Number	
4Vdc	15μF	±20%	NFMJMPC156R0G3#	D1
	22μF	±20%	NFMJMPC226R0G3#	D1
2.5Vdc	22μF	±20%	NFMJMPC226D0E3#	D1

1.6×0.8mm

Rated Voltage	Cap.	Tol.	Part Number	
16Vdc	100pF	±20%	NFM18CC101R1C3#	
	220pF	±20%	NFM18CC221R1C3#	
	470pF	±20%	NFM18CC471R1C3#	
	1000pF	±20%	NFM18CC102R1C3#	
	2200pF	±20%	NFM18CC222R1C3#	
	22000pF	±20%	NFM18CC223R1C3#	
	0.10μF	±20%	NFM18PC104R1C3#	
10Vdc	2.2μF	±20%	NFM18PC225B1A3#	
6.3Vdc	0.22μF	±20%	NFM18PC224R0J3#	
	0.47μF	±20%	NFM18PC474R0J3#	
	0.47μF	±20%	NFM18PS474R0J3#	
	1.0μF	±20%	NFM18PC105R0J3#	
6.3Vdc	1.0μF	±20%	NFM18PS105D0J3#	
	1.0μF	±20%	NFM18PS105D0J3#	

Rated Voltage	Cap.	Tol.	Part Number	
6.3Vdc	1.0μF	±20%	NFM18PS105R0J3#	
	2.2μF	±20%	NFM18PC225B0J3#	
	10μF	±20%	NFM18PC106D0J3#	D1

2.0×1.25mm

Rated Voltage	Cap.	Tol.	Part Number	
50Vdc	220pF	±20%	NFM21CC221R1H3#	
	470pF	±20%	NFM21CC471R1H3#	
	1000pF	±20%	NFM21CC102R1H3#	
	2200pF	±20%	NFM21CC222R1H3#	
	22000pF	±20%	NFM21CC223R1H3#	
25Vdc	0.10μF	±20%	NFM21PC104R1E3#	
16Vdc	0.22μF	±20%	NFM21PC224R1C3#	
	0.47μF	±20%	NFM21PC474R1C3#	
	1.0μF	±20%	NFM21PC105B1C3#	
10Vdc	1.0μF	±20%	NFM21PC105B1A3#	
	4.7μF	±20%	NFM21PC475B1A3#	
6.3Vdc	2.2μF	±20%	NFM21PC225B0J3#	
	10μF	±20%	NFM21PS106B0J3#	

3.2×1.25mm

Rated Voltage	Cap.	Tol.	Part Number	
50Vdc	220pF	+50/-20%	NFM3DCC221R1H3#	
	470pF	+50/-20%	NFM3DCC471R1H3#	
	1000pF	+50/-20%	NFM3DCC102R1H3#	
	2200pF	+50/-20%	NFM3DCC222R1H3#	
	22000pF	±20%	NFM3DPC223R1H3#	D3
	22000pF	+50/-20%	NFM3DCC223R1H3#	

3.2×1.6mm

Rated Voltage	Cap.	Tol.	Part Number	
100Vdc	10000pF	±20%	NFM31KC103R2A3#	D3
	15000pF	±20%	NFM31KC153R2A3#	
	22000pF	±20%	NFM31KC223R2A3#	
	0.10μF	±20%	NFM31KC104R2A3#	
50Vdc	10000pF	±20%	NFM31KC103R1H3#	D3
	15000pF	±20%	NFM31KC153R1H3#	D3
	22000pF	±20%	NFM31KC223R1H3#	D3
	0.10μF	±20%	NFM31KC104R1H3#	
6.3Vdc	27μF	±20%	NFM31PC276B0J3#	

4.5×1.6mm

Rated Voltage	Cap.	Tol.	Part Number	
100Vdc	470pF	+50/-20%	NFM41CC471R2A3#	
	1000pF	+50/-20%	NFM41CC102R2A3#	
	2200pF	+50/-20%	NFM41CC222R2A3#	

Part number # indicates the package specification code.

NFM Series Low ESL EMI Filter Part Number List

(→ 4.5×1.6mm)

Rated Voltage	Cap.	Tol.	Part Number	
100Vdc	22000pF	+50/-20%	NFM41CC223R2A3#	
50Vdc	1.5μF	±20%	NFM41PC155B1H3#	
25Vdc	1.5μF	±20%	NFM41PC155B1E3#	

GRM

GR3

GRJ

GR4

GJM

GQM

GA2

GA3
GB

GA3
GD

GA3
GF

LLL

LLA

LLM

LLR

NFM

GJ4

ZRA

ZRB

KRM

KR3

GMA

GMD

⚠Caution /Notice

Low Distortion Chip Multilayer Ceramic Capacitors for General Purpose

GJ4 Series



Ideal for low distortion of audio digital amplifiers.

Features

① Ideal for replacement of the film capacitors of audio circuits with low distortion characteristics.

This product is ideal for audio circuits, such as digital amplifiers where distortion characteristics are focused on. This product can be applied to filters and couplings utilizing low distortion characteristics.

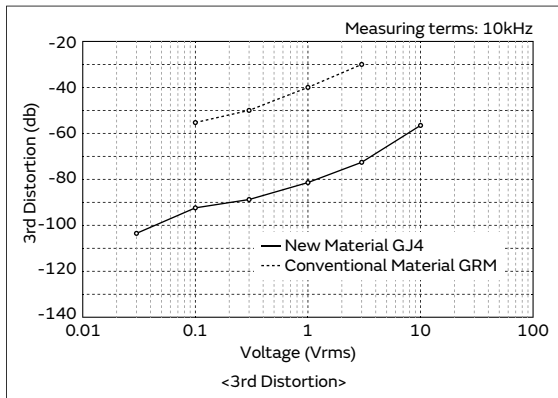

② Ideal for electronic equipment like power circuits, due to the low loss and low shock noise characteristics.

Contributes to the improvement in performance of electronic equipment where low loss and low shock noise are required.

● Measuring circuit

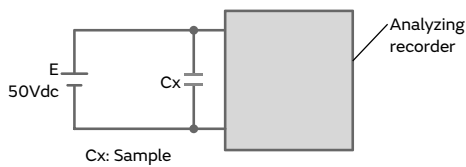

● Measuring terms

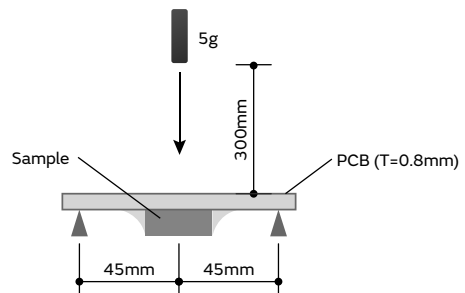

◆ New Material (GJ4)

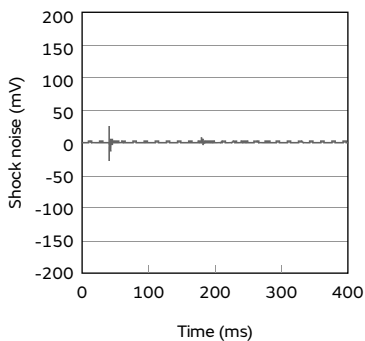

◆ Conventional Material (GRM)

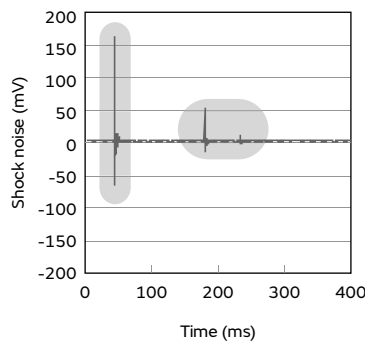

◆ Film capacitor

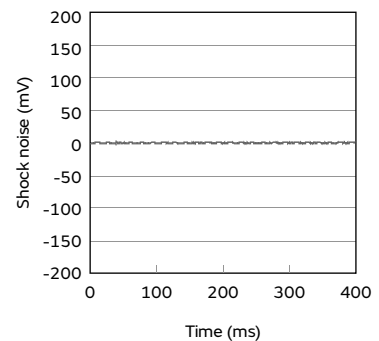

③ This product has a noise reduction effect.

Since dielectric materials which enable a reduction of noise are used, this product is more effective for reducing noise compared to the general purpose GRM series.

Specifications

Size (mm)	2.0×1.25mm to 3.2×1.6mm
Rated Voltage	25Vdc to 100Vdc
Capacitance	0.10μF to 1.0μF
Main Applications	Audio digital amplifiers, coupling circuit, filter circuits

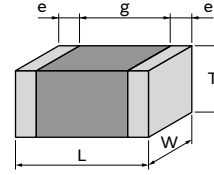

<Dimensions>

This catalog contains only a portion of the product lineup.
 Please refer to the capacitor search tool on the Murata Web site for details.

GRM

GR3

GRJ

GR4

GJM

GQM

GA2

GA3

GB

GA3

GD

GA3

GF

LLL

LLA

LLM

LLR

NFM

GJ4

ZRA

ZRB

KPM

KR3

GMA

GMD

⚠Caution /Notice

235

GJ4 Series High Dielectric Constant Type Part Number List

2.0×1.25mm

Rated Voltage	TC Code	Cap.	Tol.	Part Number	
25Vdc	X6S	0.10μF	±5%	GJ4216C81E104JA01#	
			±10%	GJ4216C81E104KA01#	
			±20%	GJ4216C81E104MA01#	
		0.15μF	±5%	GJ4219C81E154JA01#	
			±10%	GJ4219C81E154KA01#	
			±20%	GJ4219C81E154MA01#	
		0.22μF	±5%	GJ4219C81E224JA01#	
			±10%	GJ4219C81E224KA01#	
			±20%	GJ4219C81E224MA01#	
	0.33μF	±5%	GJ421BC81E334JA01#		
		±10%	GJ421BC81E334KA01#		
		±20%	GJ421BC81E334MA01#		

3.2×1.6mm

Rated Voltage	TC Code	Cap.	Tol.	Part Number	
100Vdc	X6S	0.10μF	±5%	GJ4319C82A104JA01#	
			±10%	GJ4319C82A104KA01#	
			±20%	GJ4319C82A104MA01#	
	R	0.10μF	±5%	GJ4319R82A104JA01#	
			±10%	GJ4319R82A104KA01#	
			±20%	GJ4319R82A104MA01#	
25Vdc	X6S	0.47μF	±5%	GJ4319C81E474JA01#	
			±10%	GJ4319C81E474KA01#	
			±20%	GJ4319C81E474MA01#	
		0.68μF	±5%	GJ431MC81E684JA01#	
			±10%	GJ431MC81E684KA01#	
			±20%	GJ431MC81E684MA01#	
		0.82μF	±5%	GJ431CC81E824JA01#	
			±10%	GJ431CC81E824KA01#	
			±20%	GJ431CC81E824MA01#	
		1.0μF	±5%	GJ431CC81E105JA01#	
			±10%	GJ431CC81E105KA01#	
			±20%	GJ431CC81E105MA01#	

GRM

GR3

GRJ

GR4

GJM

GQM

GA2

GA3 GB

GA3 GD

GA3 GF

LLL

LLA

LLM

LLR

NFM

GJ4

ZRA

ZRB

KPM

KR3

GMA

GMD

⚠Caution /Notice

Low Acoustic Noise Chip Multilayer Ceramic Capacitors on Interposer Board for General Purpose

ZRA Series



Reduces noise with a new structure where the capacitor is mounted on an interposer board.

Features

1 This product has a noise reduction effect.

Mounting the capacitor on an interposer board suppresses the transmission of vibration of the capacitor, which reduces the noise level.

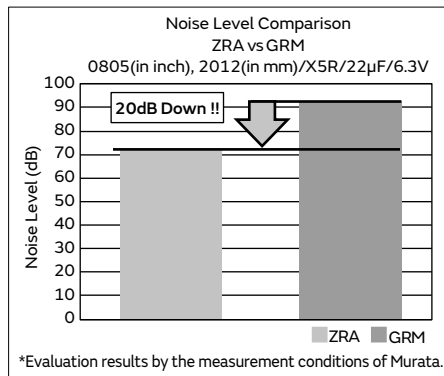
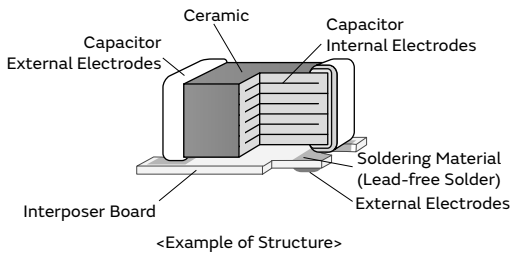

2 Designs can be performed on the same land pattern as the general-purpose product (GRM Series).

Since an interposer board of a size close to a general-purpose product (GRM Series) is used, when noise occurs, the product can be replaced without changing the land pattern (reduction of noise level).

(* When a sufficient distance between components has not been secured (when components are mounted side-by-side) a revision of the land design may be required.)

ZRA Series Recommended Land Dimensions

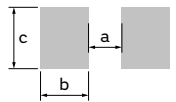
Series	L×W	MLCC Size	a	b	c	Land Size
ZRA21	2.4×1.65	2012	0.8	1.0	1.4	

Specifications

Size (mm)	2.4×1.65mm
Rated Voltage	4Vdc to 25Vdc
Capacitance	22µF to 47µF
Main Applications	Mobile phones, tablet terminals, PC, DSC, video cameras, HDD/SSD, panel related, car navigation and portable recorders

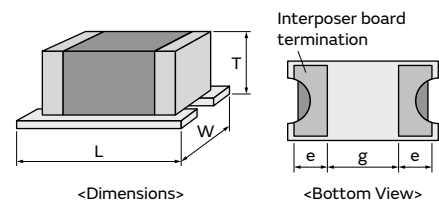

This catalog contains only a portion of the product lineup. Please refer to the capacitor search tool on the Murata Web site for details.

- GRM
- GR3
- GRJ
- GR4
- GJM
- GQM
- GA2
- GA3 GB
- GA3 GD
- GA3 GF
- LLL
- LLA
- LLM
- LLR
- NFM
- GJ4
- ZRA
- ZRB
- KRM
- KR3
- GMA
- GMD
- ⚠Caution /Notice

ZRA Series High Dielectric Constant Type Part Number List

2.4×1.65mm

Rated Voltage	TC Code	Cap.	Tol.	Part Number	
25Vdc	X5R	22μF	±20%	ZRA21CR61E226ME01#	
16Vdc	X5R	22μF	±20%	ZRA21MR61C226ME11#	D1
6.3Vdc	X5R	47μF	±20%	ZRA21MR60J476ME11#	Mo D1
4Vdc	X5R	47μF	±20%	ZRA21MR60G476ME11#	D1

GRM

GR3

GRJ

GR4

GJM

GQM

GA2

GA3
GB

GA3
GD

GA3
GF

LLL

LLA

LLM

LLR

NFM

GJ4

ZRA

ZRB

KPM

KR3

GMA

GMD

⚠Caution
/Notice

Part number # indicates the package specification code.

Low Acoustic Noise Chip Multilayer Ceramic Capacitors on Interposer Board for General Purpose

ZRB Series



Reduces noise with a new structure where the capacitor is mounted on an interposer board.

Features

1 This product has a noise reduction effect.

Mounting the capacitor on an interposer board suppresses the transmission of vibration of the capacitor, which reduces the noise level.

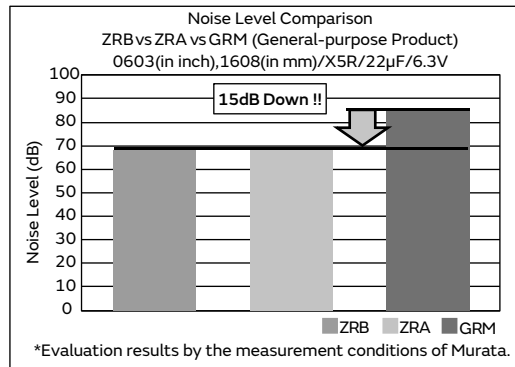
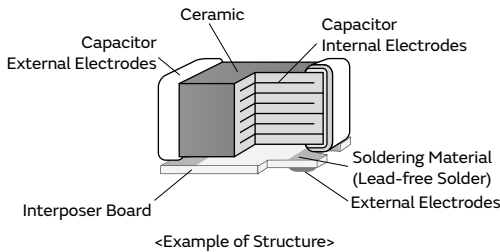

2 It is possible to replace previous MLCC without modification of the printed circuit board design.

The product is designed with the interposer board of the same LW size as MLCC by improving technology for mounting MLCC on a small board. Therefore, it is possible to replace previous MLCC with the new MLCC with an interposer board (ZRB series) that provides countermeasures for squealing without modification of the land design.

<Example of Mounting>

ZRB18AR60J226ME11

Gap between the products: 200µm

Land of mounting: Land for evaluation

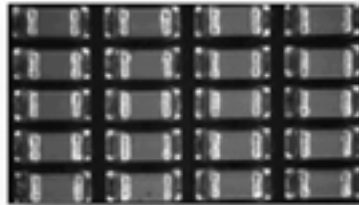

Specifications

Size (mm)	1.0×0.5mm to 1.6×0.8mm
Rated Voltage	4Vdc to 35Vdc
Capacitance	2.2µF to 47µF
Main Applications	Mobile phones, tablet terminals, PC, DSC, video cameras, HDD/SSD, panel related, car navigation and portable recorders

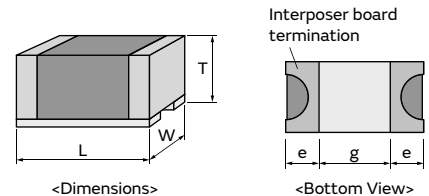

This catalog contains only a portion of the product lineup.

Please refer to the capacitor search tool on the Murata Web site for details.

ZRB Series High Dielectric Constant Type Part Number List

1.0×0.5mm

Rated Voltage	TC Code	Cap.	Tol.	Part Number	
25Vdc	X5R	2.2μF	±10%	ZRB157R61E225KE11#	
			±20%	ZRB157R61E225ME11#	
16Vdc	X6S	2.2μF	±20%	ZRB157C81C225ME01#	
			X5R	2.2μF	±10%
	±20%	ZRB157R61C225ME11#			
	10Vdc	X6S	2.2μF	±20%	ZRB157C81A225ME01#
X5R				2.2μF	±10%
		±20%	ZRB157R61A225ME11#		
			4.7μF	±20%	ZRB15XR61A475ME01#
		10μF	±20%	ZRB15XR61A106ME01#	Mo D1
6.3Vdc	X5R	4.7μF	±20%	ZRB15XR60J475ME01#	
			±20%	ZRB15XR60J106ME12#	Mo D1

1.6×0.8mm

Rated Voltage	TC Code	Cap.	Tol.	Part Number	
35Vdc	X5R	4.7μF	±10%	ZRB18AR6YA475KE05#	
			±20%	ZRB18AR6YA475ME05#	
25Vdc	X6S	4.7μF	±20%	ZRB18AC81E475ME01#	D1
	X5R	10μF	±20%	ZRB18AR61E106ME01#	
16Vdc	X6S	10μF	±20%	ZRB18AC81C106ME01#	
	X5R	10μF	±20%	ZRB18AR61C106ME01#	
10Vdc	X7T	10μF	±10%	ZRB18AD71A106KE01#	
			±20%	ZRB18AD71A106ME01#	
	X6S	10μF	±10%	ZRB18AC81A106KE01#	
			±20%	ZRB18AC81A106ME01#	
	X5R	10μF	±20%	ZRB18AR61A106ME01#	
			±20%	ZRB188R61A226ME05#	Mo D1
			±20%	ZRB18AR61A226ME01#	D1
	6.3Vdc	X6S	10μF	±20%	ZRB18AC80J106ME01#
22μF			±20%	ZRB18AC80J226ME01#	D1
X5R		22μF	±20%	ZRB186R60J226ME11#	Mo D1
			±20%	ZRB18AR60J226ME01#	D1
		47μF	±20%	ZRB18AR60J476ME01#	Mo D1
4Vdc	X6S	22μF	±20%	ZRB18AC80G226ME01#	
	X5R	22μF	±20%	ZRB186R60G226ME11#	Mo

- GRM
- GR3
- GRJ
- GR4
- GJM
- GQM
- GA2
- GA3 GB
- GA3 GD
- GA3 GF
- LLL
- LLA
- LLM
- LLR
- NFM
- GJ4
- ZRA
- ZRB
- KRM
- KR3
- GMA
- GMD
- ⚠Caution /Notice

Metal Terminal Type Multilayer Ceramic Capacitors for General Purpose

KRM Series



Low acoustic noise

Deflecting crack

Soldering crack

WEB

Bonding the metal terminals to external electrodes solves design issues by mounting large size MLCC!

Features

① **Bond metal terminals to the external electrodes of chips.**

The stress applied to the chip is relieved by the elastic action of the metal terminal.

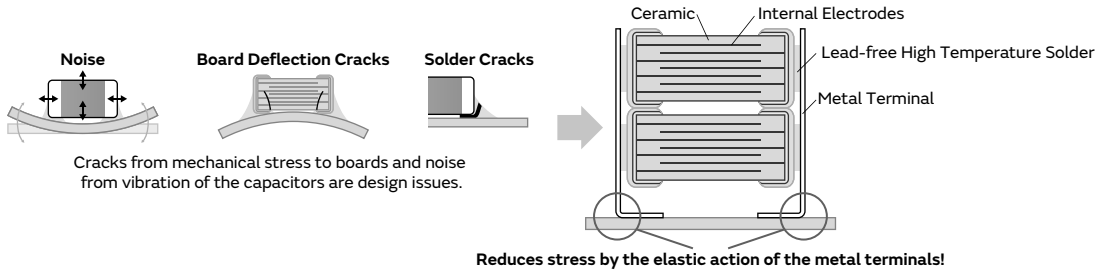

② **Substantially reduces noise, board deflection cracks and soldering cracks.**

This product is not damaged even with a board deflection of 6 mm.
 Solder cracks do not occur even with 2,000 cycles of heat stress.

● **Acoustic Noise is Reduced with Metal Terminals**

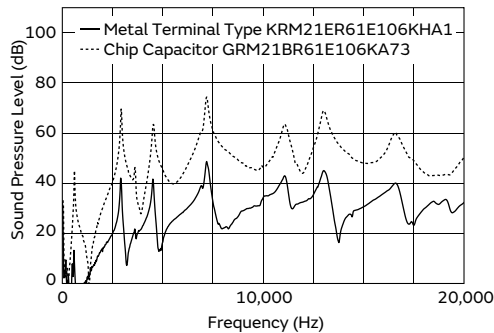

● **Reduces Stress Caused by Board Deflection**

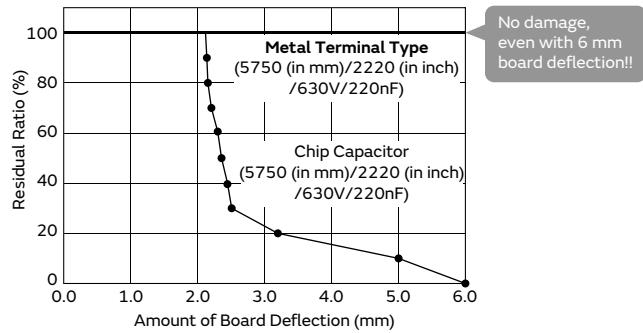

● **Suppresses Solder Cracks Caused by Heat Stress**

Chip Size	Chip Only (5750 (in mm)/2220 (in inch) size)	Metal Terminal Type (5750 (in mm)/2220 (in inch) size)
1000 Cycle	 ↑ Solder Crack	
2000 Cycle	 ↑ Solder Crack	

Compared with chips only, this product is excellent in solder cracking resistance.

Test Condition: -55 to +125°C, 5min.,(Liquid Phase)
 Board Used: Glass Epoxy Board (FR-4)

Demonstrates replacement value of low noise capacitors Experience the effectiveness of the KRM Series.

Examples of Noise Countermeasures

WEB

- GRM
- GR3
- GRJ
- GR4
- GJM
- GQM
- GA2
- GA3 GB
- GA3 GD
- GA3 GF
- LLL
- LLA
- LLM
- LLR
- NFM
- GJ4
- ZRA
- ZRB
- KRM
- KR3
- GMA
- GMD
- △Caution /Notice

③ **2 chips can be stacked.**

Realize large capacity by stacking 2 capacitors.

Specifications

Size (mm)	2.2×1.25mm to 6.1×5.3mm
Rated Voltage	16Vdc to 1250Vdc
Capacitance	8200pF to 100μF
Main Applications	For smoothing and noise suppression of DC-DC converters

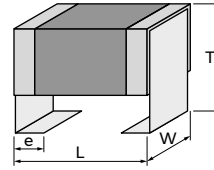

<Dimensions>

This catalog contains only a portion of the product lineup.
 Please refer to the capacitor search tool on the Murata Web site for details.

- GRM
- GR3
- GRJ
- GR4
- GJM
- GQM
- GA2
- GA3 GB
- GA3 GD
- GA3 GF
- LLL
- LLA
- LLM
- LLR
- NFM
- GJ4
- ZRA
- ZRB
- KRM**
- KR3
- GMA
- GMD
- ⚠Caution /Notice

KRM Series Temperature Compensating Type Low acoustic noise Deflecting crack Soldering crack Part Number List

6.1×5.1mm

Rated Voltage	TC Code	Cap.	Tol.	Part Number	
1250Vdc	U2J	8200pF	±5%	KRM55L7U3B822JDL1#	
		10000pF	±5%	KRM55L7U3B103JDL1#	
1000Vdc	U2J	8200pF	±5%	KRM55L7U3A822JDL1#	
		10000pF	±5%	KRM55L7U3A103JDL1#	
		0.016μF	±10%	KRM55T7U3A163KDL1#	
		0.020μF	±10%	KRM55T7U3A203KDL1#	
630Vdc	COG	0.015μF	±5%	KRM55L5C2J153JDL1#	
		0.018μF	±5%	KRM55L5C2J183JDL1#	
		0.022μF	±5%	KRM55R5C2J223JDL1#	
		0.027μF	±5%	KRM55R5C2J273JDL1#	
		0.030μF	±5%	KRM55T5C2J303JDL1#	
		0.036μF	±5%	KRM55T5C2J363JDL1#	
		0.044μF	±5%	KRM55V5C2J443JDL2#	
		0.054μF	±5%	KRM55V5C2J543JDL2#	
	U2J	33000pF	±5%	KRM55L7U2J333JDL1#	
		39000pF	±5%	KRM55L7U2J393JDL1#	
		47000pF	±5%	KRM55L7U2J473JDL1#	
		66000pF	±10%	KRM55T7U2J663KDL1#	
		78000pF	±10%	KRM55T7U2J783KDL1#	
		94000pF	±10%	KRM55T7U2J943KDL1#	

- GRM
- GR3
- GRJ
- GR4
- GJM
- GQM
- GA2
- GA3 GB
- GA3 GD
- GA3 GF
- LLL
- LLA
- LLM
- LLR
- NFM
- GJ4
- ZRA
- ZRB
- KRM
- KR3
- GMA
- GMD
- ⚠Caution /Notice

Part number # indicates the package specification code.

KRM Series High Dielectric Constant Type Low acoustic noise Deflecting crack Soldering crack Part Number List

2.2×1.25mm

Rated Voltage	TC Code	Cap.	Tol.	Part Number	
25Vdc	X7S	10μF	±10%	KRM21FC71E106KFA1#	D1
	X6S	10μF	±10%	KRM21FC81E106KFA1#	D1
	X5R	10μF	±10%	KRM21ER61E106KFA1#	
		22μF	±20%	KRM21FR61E226MFA1#	
16Vdc	X5R	10μF	±10%	KRM21ER61C106KFA1#	

3.5×1.7mm

Rated Voltage	TC Code	Cap.	Tol.	Part Number	
100Vdc	X7R	1.0μF	±10%	KRM31KR72A105KH01#	
50Vdc	X7R	4.7μF	±10%	KRM31KR71H475KH01#	
35Vdc	X6S	10μF	±10%	KRM31KC8YA106KH01#	
25Vdc	X6S	10μF	±10%	KRM31KC81E106KH01#	
	X5R	10μF	±10%	KRM31FR61E106KH01#	

3.6×1.7mm

Rated Voltage	TC Code	Cap.	Tol.	Part Number	
50Vdc	X7R	2.2μF	±10%	KRM31KR71H225KH01#	

3.7×1.85mm

Rated Voltage	TC Code	Cap.	Tol.	Part Number	
100Vdc	X7R	2.2μF	±10%	KRM31KR72A225KH01#	

6.1×5.3mm

Rated Voltage	TC Code	Cap.	Tol.	Part Number	
1000Vdc	X7R	68000pF	±10%	KRM55LR73A683KH01#	
		0.10μF	±10%	KRM55LR73A104KH01#	
		0.15μF	±20%	KRM55TR73A154MH01#	
		0.22μF	±20%	KRM55TR73A224MH01#	
630Vdc	X7R	0.15μF	±10%	KRM55LR72J154KH01#	
		0.22μF	±10%	KRM55LR72J224KH01#	
		0.33μF	±20%	KRM55TR72J334MH01#	
		0.47μF	±20%	KRM55TR72J474MH01#	
450Vdc	X7R	0.33μF	±10%	KRM55LR72W334KH01#	
		0.47μF	±10%	KRM55LR72W474KH01#	
		0.68μF	±20%	KRM55TR72W684MH01#	
		1.0μF	±20%	KRM55TR72W105MH01#	
250Vdc	X7R	0.68μF	±10%	KRM55LR72E684KH01#	
		1.0μF	±10%	KRM55LR72E105KH01#	
		1.5μF	±20%	KRM55TR72E155MH01#	
		2.2μF	±20%	KRM55TR72E225MH01#	
100Vdc	X7R	4.7μF	±10%	KRM55LR72A475KH01#	
		6.8μF	±10%	KRM55QR72A685KH01#	
		10μF	±10%	KRM55QR72A106KH01#	
			±20%	KRM55TR72A106MH01#	

Rated Voltage	TC Code	Cap.	Tol.	Part Number	
100Vdc	X7R	15μF	±20%	KRM55WR72A156MH01#	
		22μF	±20%	KRM55WR72A226MH01#	
63Vdc	X7R	4.7μF	±10%	KRM55LR71J475KH01#	
		10μF	±10%	KRM55QR71J106KH01#	
		22μF	±20%	KRM55WR71J226MH01#	
			±20%	KRM55WR71J226MH01#	
50Vdc	X7R	4.7μF	±10%	KRM55LR71H475KH01#	
		10μF	±10%	KRM55LR71H106KH01#	
			±10%	KRM55QR71H106KH01#	
		17μF	±10%	KRM55QR71H176KH01#	
		22μF	±20%	KRM55TR71H226MH01#	
			±20%	KRM55WR71H226MH01#	
		33μF	±20%	KRM55WR71H336MH01#	
			±20%	KRM55WR71H336MH01#	
35Vdc	X7R	10μF	±10%	KRM55LR7YA106KH01#	
		15μF	±10%	KRM55LR7YA156KH01#	
		17μF	±10%	KRM55QR7YA176KH01#	
		22μF	±10%	KRM55QR7YA226KH01#	
			±20%	KRM55TR7YA226MH01#	
		33μF	±20%	KRM55TR7YA336MH01#	
			±20%	KRM55WR7YA336MH01#	
		47μF	±20%	KRM55WR7YA476MH01#	
25Vdc	X7R	15μF	±10%	KRM55LR71E156KH01#	
		22μF	±10%	KRM55QR71E226KH01#	
		33μF	±10%	KRM55QR71E336KH01#	
			±20%	KRM55TR71E336MH01#	
	47μF	±20%	KRM55WR71E476MH01#		
		±20%	KRM55WR71E476MH01#		
	X7S	47μF	±10%	KRM55QC71E476KH13#	
		100μF	±20%	KRM55WC71E107MH13#	

- GRM
- GR3
- GRJ
- GR4
- GJM
- GQM
- GQ2
- GA3 GB
- GA3 GD
- GA3 GF
- LLL
- LLA
- LLM
- LLR
- NFM
- GJ4
- ZRA
- ZRB
- KRM
- KR3
- GMA
- GMD
- ⚠Caution /Notice

Part number # indicates the package specification code.

High Effective Capacitance & High Allowable Ripple Current Metal Terminal Type Multilayer Ceramic Capacitors for General Purpose

KR3 Series



Low acoustic noise

Deflecting crack

Soldering crack

WEB

Bonding the metal terminals to external electrodes solves design issues by mounting large size MLCC!

Features

1 Bond Metal Terminals to External Electrodes of Chips

This product has high resistance to heat and mechanical impact and greatly reduces acoustic noise of boards by ceramics.

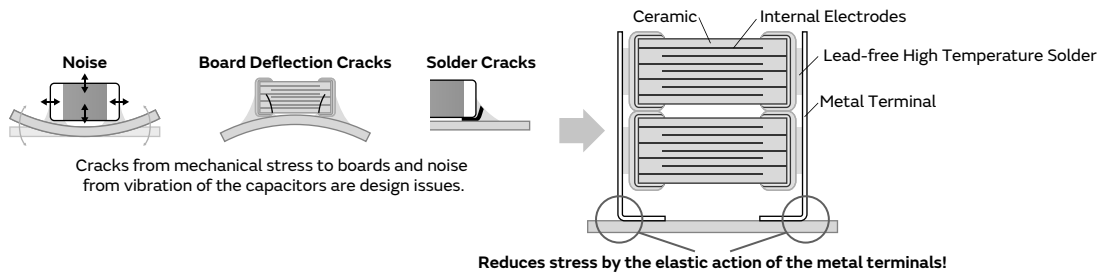

2 Stacking of Chips

Achieve high capacity by stacking 2 capacitors.

Comparison of Noise Reduction Effects

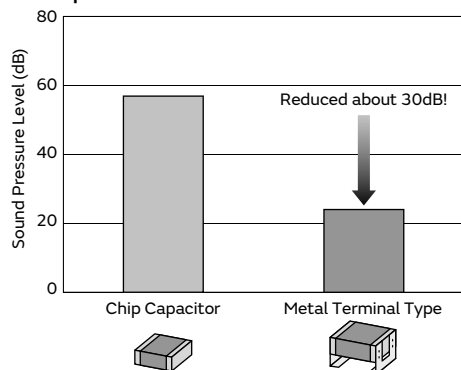

Evaluation Items: 5750 (in mm)/2220 (in inch) size/DC630V/220nF
 Test Method: DC50V, AC10Vp-p/3kHz
 Test Board: Glass Epoxy Board (T=1.6mm)
 Test Quantity: 3pc
 Distance Between Microphone and Board: 5mm

Note: Results Using Murata's Evaluation Board

Reduces Stress Caused by Board Deflection

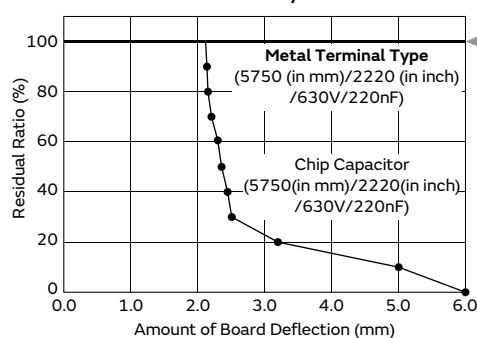

Suppresses Solder Cracks Caused by Heat Stress

Chip Size	Chip Only (5750 (in mm)/2220 (in inch) size)	Metal Terminal Type (5750 (in mm)/2220 (in inch) size)
1000 Cycle	 ↑ Solder Crack	
2000 Cycle	 ↑ Solder Crack	

Compared with chips only, this product is excellent in solder cracking resistance.

Test Condition: -55 to +125°C, 5min., (Liquid Phase)
 Board Used: Glass Epoxy Board (FR-4)

3 Adopted Low Dielectric Constant Materials

Improved effective capacity and ripple resistant performance, compared to conventional products (X7R characteristics).

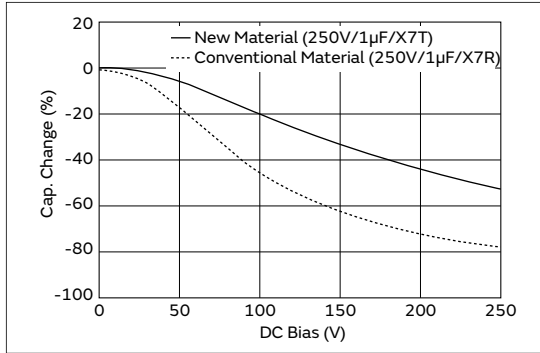

Specifications

Size (mm)	6.1×5.3mm
Rated Voltage	250Vdc to 630Vdc
Capacitance	0.10µF to 2.2µF
Main Applications	For DC-DC converters of general electronic equipment

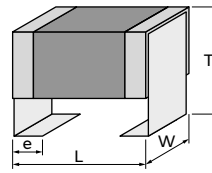

<Dimensions>

This catalog contains only a portion of the product lineup.
 Please refer to the capacitor search tool on the Murata Web site for details.

- GRM
- GR3
- GRJ
- GR4
- GJM
- GQM
- GA2
- GA3 GB
- GA3 GD
- GA3 GF
- LLL
- LLA
- LLM
- LLR
- NFM
- GJ4
- ZRA
- ZRB
- KRM
- KR3
- GMA
- GMD
- ⚠Caution /Notice

KR3 Series High Dielectric Constant Type Low acoustic noise Deflecting crack Soldering crack Part Number List

6.1×5.3mm

Rated Voltage	TC Code	Cap.	Tol.	Part Number	
630Vdc	X7T	0.10μF	±10%	KR355LD72J104KH01#	
		0.15μF	±10%	KR355LD72J154KH01#	
		0.22μF	±10%	KR355QD72J224KH01#	
		0.27μF	±10%	KR355QD72J274KH01#	
		0.47μF	±20%	KR355WD72J474MH01#	
		0.56μF	±20%	KR355WD72J564MH01#	
450Vdc	X7T	0.22μF	±10%	KR355LD72W224KH01#	
		0.33μF	±10%	KR355LD72W334KH01#	
		0.47μF	±10%	KR355LD72W474KH01#	
		0.56μF	±10%	KR355QD72W564KH01#	
		0.68μF	±20%	KR355TD72W684MH01#	
		1.0μF	±20%	KR355TD72W105MH01#	
		1.2μF	±20%	KR355WD72W125MH01#	
250Vdc	X7T	0.47μF	±10%	KR355LD72E474KH01#	
		0.68μF	±10%	KR355LD72E684KH01#	
		1.0μF	±10%	KR355QD72E105KH01#	
		1.5μF	±20%	KR355TD72E155MH01#	
		2.2μF	±20%	KR355WD72E225MH01#	

- GRM
- GR3
- GRJ
- GR4
- GJM
- GQM
- GA2
- GA3 GB
- GA3 GD
- GA3 GF
- LLL
- LLA
- LLM
- LLR
- NFM
- GJ4
- ZRA
- ZRB
- KRM
- KR3
- GMA
- GMD
- ⚠Caution /Notice

Part number # indicates the package specification code.

Wire Bonding Mount Multilayer Microchip Capacitors for General Purpose

GMA Series



These capacitors have gold-plated electrodes and are designed specifically for wire bonding.

Features

① **Allows for high density mounting.**

Noise can be reduced by eliminating the routing of the wire, and high efficiency can be achieved with a built-in capacitor in a package, such as IC. Miniaturization of the set is also possible.

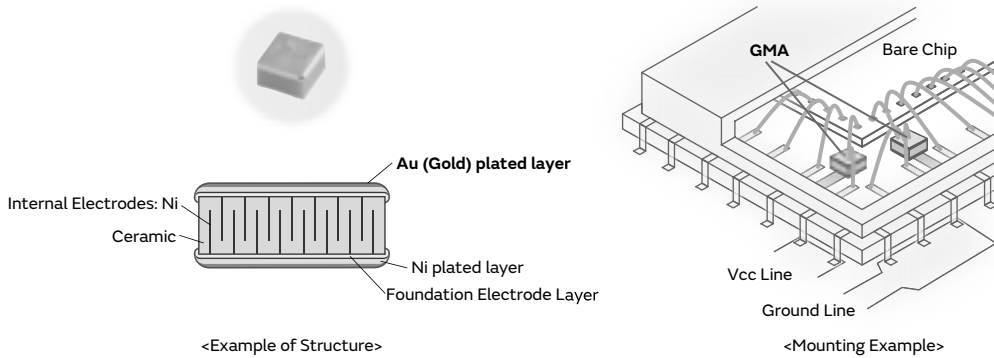

② **Achieved small size and high capacitance with a multilayer structure.**

Small size, high capacitance	Minimum 0.38mm×0.38mm Achieved 0.1μF in 0.5mm×0.5mm size
------------------------------	---

Lineup comparison table with competitor's is provided in my Murata Capacitor Site (need to sign in & approval from the site)



③ **Ideal for bypass applications**

Especially for optical communication related devices such as TOSA/ROSA.

④ **Excellent in high frequency characteristics.**

Since the capacitor consists of an upper/lower electrode structure, the current path becomes shorter and lowers the ESL. Compared with the general purpose GRM series of the same capacity, the impedance of this product becomes lower at high frequencies.

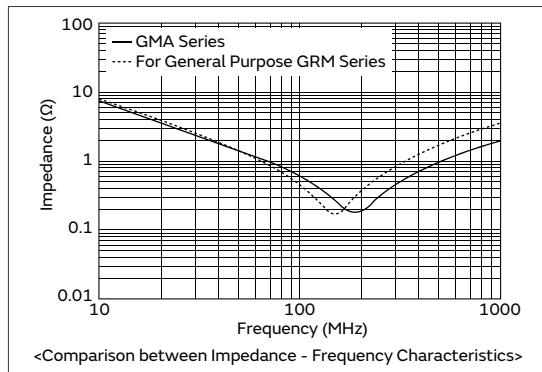

- GRM
- GR3
- GRJ
- GR4
- GJM
- GQM
- GA2
- GA3 GB
- GA3 GD
- GA3 GF
- LLL
- LLA
- LLM
- LLR
- NFM
- GJ4
- ZRA
- ZRB
- KRM
- KR3
- GMA
- GMD
- ⚠Caution /Notice

Specifications

Size (mm)	0.38×0.38mm to 0.8×0.8mm
Rated Voltage	6.3Vdc to 100Vdc
Capacitance	100pF to 0.47μF
Main Applications	<ol style="list-style-type: none"> 1. Optical communication related devices such as TOSA/ROSA. 2. Various device related, such as GaAsIC (mounted in IC packages) 3. Measuring instruments, other ultra compact/thin devices

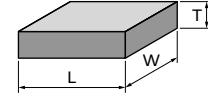

<Dimensions>

This catalog contains only a portion of the product lineup.
 Please refer to the capacitor search tool on the Murata Web site for details.

GRM

GR3

GRJ

GR4

GJM

GQM

GA2

GA3
GB

GA3
GD

GA3
GF

LLL

LLA

LLM

LLR

NFM

GJ4

ZRA

ZRB

KRM

KR3

GMA

GMD

⚠Caution
/Notice

249

GMA Series High Dielectric Constant Type **Bonding** Part Number List

0.38×0.38mm

Rated Voltage	TC Code	Cap.	Tol.	Part Number			
10Vdc	X7R	820pF	±20%	GMA0D3R71A821MA01#			
		1000pF	±20%	GMA0D3R71A102MA01#			
		1500pF	±20%	GMA0D3R71A152MA01#			
		1800pF	±20%	GMA0D3R71A182MA01#			
		2200pF	±20%	GMA0D3R71A222MA01#			
		3300pF	±20%	GMA0D3R71A332MA01#			
		4700pF	±20%	GMA0D3R71A472MA01#			
		6800pF	±20%	GMA0D3R71A682MA01#			
		10000pF	±10%	GMA0D3R71A103KA01#			
				±20%	GMA0D3R71A103MA01#		
		R	820pF	±20%	GMA0D3R11A821MA01#		
			1000pF	±20%	GMA0D3R11A102MA01#		
	1500pF		±20%	GMA0D3R11A152MA01#			
	1800pF		±20%	GMA0D3R11A182MA01#			
	2200pF		±20%	GMA0D3R11A222MA01#			
	3300pF		±20%	GMA0D3R11A332MA01#			
	4700pF		±20%	GMA0D3R11A472MA01#			
	6800pF		±20%	GMA0D3R11A682MA01#			
	10000pF		±10%	GMA0D3R11A103KA01#			
				±20%	GMA0D3R11A103MA01#		
	B		820pF	±20%	GMA0D3B11A821MA01#		
			1000pF	±20%	GMA0D3B11A102MA01#		
		1500pF	±20%	GMA0D3B11A152MA01#			
		1800pF	±20%	GMA0D3B11A182MA01#			
		2200pF	±20%	GMA0D3B11A222MA01#			
		3300pF	±20%	GMA0D3B11A332MA01#			
		4700pF	±20%	GMA0D3B11A472MA01#			
		6800pF	±20%	GMA0D3B11A682MA01#			
		10000pF	±10%	GMA0D3B11A103KA01#			
				±20%	GMA0D3B11A103MA01#		
		6.3Vdc	X7R	10000pF	±10%	GMA0D3R70J103KA01#	
					±20%	GMA0D3R70J103MA01#	
	R			10000pF	±10%	GMA0D3R10J103KA01#	
					±20%	GMA0D3R10J103MA01#	
				B	10000pF	±10%	GMA0D3B10J103KA01#
						±20%	GMA0D3B10J103MA01#

0.5×0.5mm

Rated Voltage	TC Code	Cap.	Tol.	Part Number		
100Vdc	X7R	100pF	±20%	GMA05XR72A101MA01#		
		150pF	±20%	GMA05XR72A151MA01#		
		160pF	±20%	GMA05XR72A161MA01#		
		220pF	±20%	GMA05XR72A221MA01#		
		330pF	±20%	GMA05XR72A331MA01#		
		430pF	±20%	GMA05XR72A431MA01#		
		470pF	±20%	GMA05XR72A471MA01#		
		680pF	±20%	GMA05XR72A681MA01#		
		1000pF	±20%	GMA05XR72A102MA01#		
		50Vdc	X7R	100pF	±20%	GMA05XR71H101MA01#
				150pF	±20%	GMA05XR71H151MA01#

Rated Voltage	TC Code	Cap.	Tol.	Part Number			
50Vdc	X7R	160pF	±20%	GMA05XR71H161MA01#			
		220pF	±20%	GMA05XR71H221MA01#			
		330pF	±20%	GMA05XR71H331MA01#			
		430pF	±20%	GMA05XR71H431MA01#			
		470pF	±20%	GMA05XR71H471MA01#			
		680pF	±20%	GMA05XR71H681MA01#			
		1000pF	±20%	GMA05XR71H102MA01#			
		R	100pF	±20%	GMA05XR11H101MA01#		
			150pF	±20%	GMA05XR11H151MA01#		
			160pF	±20%	GMA05XR11H161MA01#		
			220pF	±20%	GMA05XR11H221MA01#		
			330pF	±20%	GMA05XR11H331MA01#		
	430pF		±20%	GMA05XR11H431MA01#			
	470pF		±20%	GMA05XR11H471MA01#			
	680pF		±20%	GMA05XR11H681MA01#			
	1000pF		±20%	GMA05XR11H102MA01#			
	B		100pF	±20%	GMA05XB11H101MA01#		
			150pF	±20%	GMA05XB11H151MA01#		
			160pF	±20%	GMA05XB11H161MA01#		
		220pF	±20%	GMA05XB11H221MA01#			
		330pF	±20%	GMA05XB11H331MA01#			
		430pF	±20%	GMA05XB11H431MA01#			
		470pF	±20%	GMA05XB11H471MA01#			
		680pF	±20%	GMA05XB11H681MA01#			
		1000pF	±20%	GMA05XB11H102MA01#			
		25Vdc	X7R	1500pF	±20%	GMA05XR71E152MA11#	
				2200pF	±20%	GMA05XR71E222MA11#	
				3300pF	±20%	GMA05XR71E332MA11#	
	4700pF			±20%	GMA05XR71E472MA11#		
	B			1500pF	±20%	GMA05XB31E152MA11#	
				2200pF	±20%	GMA05XB31E222MA11#	
			3300pF	±20%	GMA05XB31E332MA11#		
			4700pF	±20%	GMA05XB31E472MA11#		
			16Vdc	X7R	430pF	±20%	GMA05XR71C431MA01#
					470pF	±20%	GMA05XR71C471MA01#
	680pF				±20%	GMA05XR71C681MA01#	
1000pF	±20%				GMA05XR71C102MA01#		
1500pF	±20%	GMA05XR71C152MA01#					
2200pF	±20%	GMA05XR71C222MA01#					
3300pF	±20%	GMA05XR71C332MA01#					
4700pF	±20%	GMA05XR71C472MA01#					
R	430pF	±20%			GMA05XR11C431MA01#		
	470pF	±20%			GMA05XR11C471MA01#		
	680pF	±20%			GMA05XR11C681MA01#		
	1000pF	±20%			GMA05XR11C102MA01#		
	1500pF	±20%	GMA05XR11C152MA01#				
	2200pF	±20%	GMA05XR11C222MA01#				
B	430pF	±20%	GMA05XB11C431MA01#				
	470pF	±20%	GMA05XB11C471MA01#				
	680pF	±20%	GMA05XB11C681MA01#				
	1000pF	±20%	GMA05XB11C102MA01#				
	1500pF	±20%	GMA05XB11C152MA01#				

Part number # indicates the package specification code.

GRM
 GR3
 GRJ
 GR4
 GJM
 GQM
 GA2
 GA3 GB
 GA3 GD
 GA3 GF
 LLL
 LLA
 LLM
 LLR
 NFM
 GJ4
 ZRA
 ZRB
 KRM
 KR3
 GMA
 GMD
 ⚠Caution /Notice

GMA Series High Dielectric Constant Type Bonding Part Number List

(→ 0.5×0.5mm)

Rated Voltage	TC Code	Cap.	Tol.	Part Number	
16Vdc	B	2200pF	±20%	GMA05XB11C222MA01#	
		3300pF	±20%	GMA05XB11C332MA01#	
		4700pF	±20%	GMA05XB11C472MA01#	
10Vdc	X7R	6800pF	±10%	GMA05XR71A682KA01#	
			±20%	GMA05XR71A682MA01#	
		10000pF	±10%	GMA05XR71A103KA01#	
			±20%	GMA05XR71A103MA01#	
		15000pF	±10%	GMA05XR71A153KA01#	
			±20%	GMA05XR71A153MA01#	
	22000pF	±10%	GMA05XR71A223KA01#		
		±20%	GMA05XR71A223MA01#		
	R	6800pF	±10%	GMA05XR11A682KA01#	
			±20%	GMA05XR11A682MA01#	
		10000pF	±10%	GMA05XR11A103KA01#	
			±20%	GMA05XR11A103MA01#	
		15000pF	±10%	GMA05XR11A153KA01#	
			±20%	GMA05XR11A153MA01#	
	22000pF	±10%	GMA05XR11A223KA01#		
		±20%	GMA05XR11A223MA01#		
	B	6800pF	±10%	GMA05XB11A682KA01#	
			±20%	GMA05XB11A682MA01#	
10000pF		±10%	GMA05XB11A103KA01#		
		±20%	GMA05XB11A103MA01#		
15000pF		±10%	GMA05XB11A153KA01#		
		±20%	GMA05XB11A153MA01#		
22000pF	±10%	GMA05XB11A223KA01#			
	±20%	GMA05XB11A223MA01#			
6.3Vdc	X7R	6800pF	±10%	GMA05XR70J682KA01#	
			±20%	GMA05XR70J682MA01#	
		10000pF	±10%	GMA05XR70J103KA01#	
			±20%	GMA05XR70J103MA01#	
		15000pF	±10%	GMA05XR70J153KA01#	
			±20%	GMA05XR70J153MA01#	
		22000pF	±10%	GMA05XR70J223KA01#	
			±20%	GMA05XR70J223MA01#	
		R	6800pF	±10%	GMA05XR10J682KA01#
				±20%	GMA05XR10J682MA01#
			10000pF	±10%	GMA05XR10J103KA01#
				±20%	GMA05XR10J103MA01#
	15000pF		±10%	GMA05XR10J153KA01#	
			±20%	GMA05XR10J153MA01#	
	22000pF	±10%	GMA05XR10J223KA01#		
		±20%	GMA05XR10J223MA01#		
	X6S	47000pF	±10%	GMA05XC80J473KE12#	
			±20%	GMA05XC80J473ME12#	
		0.10μF	±10%	GMA05XC80J104KE12#	
			±20%	GMA05XC80J104ME12#	
	X5R	47000pF	±10%	GMA05XR60J473KE12#	
			±20%	GMA05XR60J473ME12#	
		0.10μF	±10%	GMA05XR60J104KE12#	
			±20%	GMA05XR60J104ME12#	
B	6800pF	±10%	GMA05XB10J682KA01#		
		±20%	GMA05XB10J682MA01#		
	10000pF	±10%	GMA05XB10J103KA01#		

Rated Voltage	TC Code	Cap.	Tol.	Part Number
6.3Vdc	B	1000pF	±20%	GMA05XB10J103MA01#
		1500pF	±10%	GMA05XB10J153KA01#
			±20%	GMA05XB10J153MA01#
		2200pF	±10%	GMA05XB10J223KA01#
			±20%	GMA05XB10J223MA01#
		4700pF	±10%	GMA05XB30J473KE12#
			±20%	GMA05XB30J473ME12#
		0.10μF	±10%	GMA05XB30J104KE12#
			±20%	GMA05XB30J104ME12#

0.8×0.8mm

Rated Voltage	TC Code	Cap.	Tol.	Part Number		
100Vdc	X7R	330pF	±20%	GMA085R72A331MA01#		
		470pF	±20%	GMA085R72A471MA01#		
		680pF	±20%	GMA085R72A681MA01#		
		1000pF	±20%	GMA085R72A102MA01#		
		1500pF	±20%	GMA085R72A152MA01#		
		2200pF	±20%	GMA085R72A222MA01#		
		3300pF	±20%	GMA085R72A332MA01#		
		4700pF	±20%	GMA085R72A472MA01#		
		6800pF	±20%	GMA085R72A682MA01#		
		50Vdc	X7R	330pF	±20%	GMA085R71H331MA01#
				470pF	±20%	GMA085R71H471MA01#
				680pF	±20%	GMA085R71H681MA01#
				1000pF	±20%	GMA085R71H102MA01#
				1500pF	±20%	GMA085R71H152MA01#
				2200pF	±20%	GMA085R71H222MA01#
R	330pF		±20%	GMA085R11H331MA01#		
	470pF		±20%	GMA085R11H471MA01#		
	680pF		±20%	GMA085R11H681MA01#		
	1000pF		±20%	GMA085R11H102MA01#		
	1500pF		±20%	GMA085R11H152MA01#		
	2200pF		±20%	GMA085R11H222MA01#		
B	330pF	±20%	GMA085B11H331MA01#			
	470pF	±20%	GMA085B11H471MA01#			
	680pF	±20%	GMA085B11H681MA01#			
	1000pF	±20%	GMA085B11H102MA01#			
	1500pF	±20%	GMA085B11H152MA01#			
	2200pF	±20%	GMA085B11H222MA01#			
	3300pF	±20%	GMA085B11H332MA01#			
	4700pF	±20%	GMA085B11H472MA01#			
	6800pF	±20%	GMA085B11H682MA01#			
	25Vdc	X7R	1000pF	±20%	GMA085R71E103MA11#	
			1500pF	±20%	GMA085R71E153MA11#	
			2200pF	±20%	GMA085R71E223MA11#	
B		1000pF	±20%	GMA085B31E103MA11#		

Part number # indicates the package specification code.

- GRM
- GR3
- GRJ
- GR4
- GJM
- GQM
- GA2
- GA3 GB
- GA3 GD
- GA3 GF
- LLL
- LLA
- LLM
- LLR
- NFM
- GJ4
- ZRA
- ZRB
- KRM
- KR3
- GMA
- GMD
- ⚠Caution /Notice

GMA Series High Dielectric Constant Type Bonding Part Number List

(→ 0.8×0.8mm)

Rated Voltage	TC Code	Cap.	Tol.	Part Number	Rated Voltage	TC Code	Cap.	Tol.	Part Number		
25Vdc	B	15000pF	±20%	GMA085B31E153MA11#	6.3Vdc	X7R	3300pF	±20%	GMA085R70J333MA01#		
		22000pF	±20%	GMA085B31E223MA11#			4700pF	±10%	GMA085R70J473KA01#		
16Vdc	X7R	1000pF	±20%	GMA085R71C102MA01#						±20%	GMA085R70J473MA01#
		1500pF	±20%	GMA085R71C152MA01#			68000pF	±10%	GMA085R70J683KA01#		
		2200pF	±20%	GMA085R71C222MA01#					±20%	GMA085R70J683MA01#	
		3300pF	±20%	GMA085R71C332MA01#			0.10μF	±10%	GMA085R70J104KA01#		
		4700pF	±20%	GMA085R71C472MA01#				±20%	GMA085R70J104MA01#		
		6800pF	±20%	GMA085R71C682MA01#			R	33000pF	±10%	GMA085R10J333KA01#	
		10000pF	±20%	GMA085R71C103MA01#					±20%	GMA085R10J333MA01#	
		15000pF	±20%	GMA085R71C153MA01#				47000pF	±10%	GMA085R10J473KA01#	
		22000pF	±20%	GMA085R71C223MA01#					±20%	GMA085R10J473MA01#	
		R	R	1000pF			±20%	GMA085R11C102MA01#	68000pF	±10%	GMA085R10J683KA01#
1500pF	±20%			GMA085R11C152MA01#				±20%	GMA085R10J683MA01#		
2200pF	±20%			GMA085R11C222MA01#			0.10μF	±10%	GMA085R10J104KA01#		
3300pF	±20%			GMA085R11C332MA01#	±20%	GMA085R10J104MA01#					
4700pF	±20%			GMA085R11C472MA01#	X6S	0.47μF	±10%	GMA085C80J474KE12#			
6800pF	±20%			GMA085R11C682MA01#			±20%	GMA085C80J474ME12#			
10000pF	±20%			GMA085R11C103MA01#	X5R	0.47μF	±10%	GMA085R60J474KE12#			
15000pF	±20%			GMA085R11C153MA01#			±20%	GMA085R60J474ME12#			
22000pF	±20%			GMA085R11C223MA01#	B	33000pF	±10%	GMA085B10J333KA01#			
B	B			1000pF		±20%	GMA085B11C102MA01#		±20%	GMA085B10J333MA01#	
		1500pF	±20%	GMA085B11C152MA01#		47000pF	±10%	GMA085B10J473KA01#			
		2200pF	±20%	GMA085B11C222MA01#			±20%	GMA085B10J473MA01#			
		3300pF	±20%	GMA085B11C332MA01#		68000pF	±10%	GMA085B10J683KA01#			
		4700pF	±20%	GMA085B11C472MA01#			±20%	GMA085B10J683MA01#			
		6800pF	±20%	GMA085B11C682MA01#		0.10μF	±10%	GMA085B10J104KA01#			
		10000pF	±20%	GMA085B11C103MA01#			±20%	GMA085B10J104MA01#			
		15000pF	±20%	GMA085B11C153MA01#		0.47μF	±10%	GMA085B30J474KE12#			
		22000pF	±20%	GMA085B11C223MA01#			±20%	GMA085B30J474ME12#			
		10Vdc	X7R	33000pF	±10%	GMA085R71A333KA01#					
±20%	GMA085R71A333MA01#										
47000pF	±10%			GMA085R71A473KA01#							
	±20%			GMA085R71A473MA01#							
68000pF	±10%			GMA085R71A683KA01#							
	±20%			GMA085R71A683MA01#							
0.10μF	±10%			GMA085R71A104KA01#							
	±20%			GMA085R71A104MA01#							
R	33000pF			±10%	GMA085R11A333KA01#						
				±20%	GMA085R11A333MA01#						
	47000pF		±10%	GMA085R11A473KA01#							
			±20%	GMA085R11A473MA01#							
	68000pF		±10%	GMA085R11A683KA01#							
			±20%	GMA085R11A683MA01#							
	0.10μF		±10%	GMA085R11A104KA01#							
			±20%	GMA085R11A104MA01#							
B	33000pF		±10%	GMA085B11A333KA01#							
			±20%	GMA085B11A333MA01#							
	47000pF		±10%	GMA085B11A473KA01#							
			±20%	GMA085B11A473MA01#							
	68000pF	±10%	GMA085B11A683KA01#								
		±20%	GMA085B11A683MA01#								
	0.10μF	±10%	GMA085B11A104KA01#								
		±20%	GMA085B11A104MA01#								
6.3Vdc	X7R	33000pF	±10%	GMA085R70J333KA01#							

- GRM
- GR3
- GRJ
- GR4
- GJM
- GQM
- GA2
- GA3 GB
- GA3 GD
- GA3 GF
- LLL
- LLA
- LLM
- LLR
- NFM
- GJ4
- ZRA
- ZRB
- KRM
- KR3
- GMA
- GMD
- ⚠Caution /Notice

Part number # indicates the package specification code.

Wire Bonding/AuSn Soldering Mount Chip Multilayer Ceramic Capacitors for General Purpose

GMD Series



These capacitors have gold-plated electrodes and are designed specifically for wire bonding and use of gold-tin (AuSn) solder.

Features

① Designed specifically for wire bonding and use of gold-tin (AuSn) solder.

The gold-plated external electrodes make these devices suitable for wire bonding or use of gold tin (AuSn) solder.

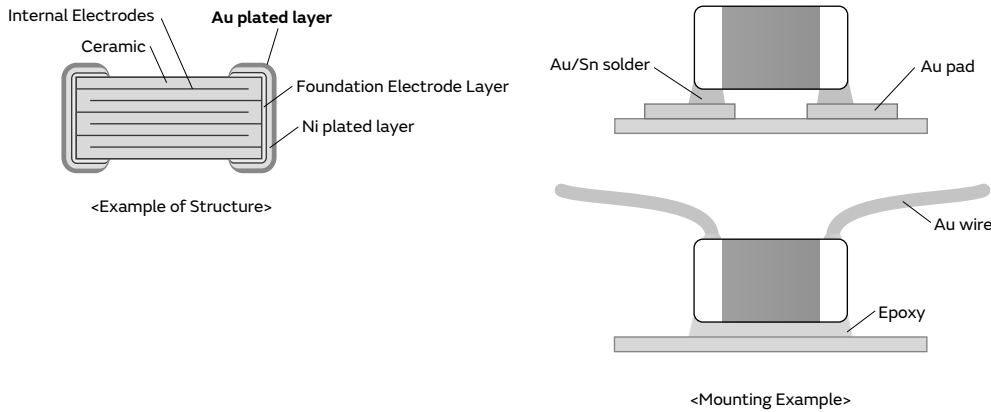

*This product is suitable only for wire bonding or use of gold-tin (AuSn) solder. Other mounting methods should not be used.

② Ideal for mounting in packages, such as optical communication related devices, IC and etc.

Noise can be reduced by eliminating the routing of the wire, and high efficiency can be achieved with a built-in capacitor in the package, such as TO-CAN, IC and etc. by wire bonding mounting.

③ Contributes to the miniaturization of the set.

Murata offers a lineup of small size products, such as the 0603 (0201) and 1005 (0402) in mm (inch).

Specifications

Size (mm)	0.6×0.3mm to 1.0×0.5mm
Rated Voltage	6.3Vdc to 50Vdc
Capacitance	100pF to 1.0μF
Main Applications	Various device related, such as GaAsIC (mounted in IC packages)

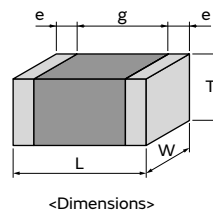

This catalog contains only a portion of the product lineup. Please refer to the capacitor search tool on the Murata Web site for details.

GRM
 GR3
 GRJ
 GR4
 GJM
 GQM
 GA2
 GA3 GB
 GA3 GD
 GA3 GF
 LLL
 LLA
 LLM
 LLR
 NFM
 GJ4
 ZRA
 ZRB
 KPM
 KR3
 GMA
GMD
 ⚠Caution / Notice

GMD Series High Dielectric Constant Type Bonding Part Number List

0.6×0.3mm

Rated Voltage	TC Code	Cap.	Tol.	Part Number	
25Vdc	X7R	100pF	±10%	GMD033R71E101KA01#	
			±20%	GMD033R71E101MA01#	
		120pF	±10%	GMD033R71E121KA01#	
			±20%	GMD033R71E121MA01#	
		150pF	±10%	GMD033R71E151KA01#	
			±20%	GMD033R71E151MA01#	
		180pF	±10%	GMD033R71E181KA01#	
			±20%	GMD033R71E181MA01#	
		220pF	±10%	GMD033R71E221KA01#	
			±20%	GMD033R71E221MA01#	
		270pF	±10%	GMD033R71E271KA01#	
			±20%	GMD033R71E271MA01#	
		330pF	±10%	GMD033R71E331KA01#	
			±20%	GMD033R71E331MA01#	
		390pF	±10%	GMD033R71E391KA01#	
			±20%	GMD033R71E391MA01#	
		470pF	±10%	GMD033R71E471KA01#	
			±20%	GMD033R71E471MA01#	
		560pF	±10%	GMD033R71E561KA01#	
			±20%	GMD033R71E561MA01#	
	680pF	±10%	GMD033R71E681KA01#		
		±20%	GMD033R71E681MA01#		
	820pF	±10%	GMD033R71E821KA01#		
		±20%	GMD033R71E821MA01#		
	1000pF	±10%	GMD033R71E102KA01#		
		±20%	GMD033R71E102MA01#		
	1200pF	±10%	GMD033R71E122KA01#		
		±20%	GMD033R71E122MA01#		
	1500pF	±10%	GMD033R71E152KA01#		
		±20%	GMD033R71E152MA01#		
	R	100pF	±10%	GMD033R11E101KA01#	
			±20%	GMD033R11E101MA01#	
		120pF	±10%	GMD033R11E121KA01#	
			±20%	GMD033R11E121MA01#	
		150pF	±10%	GMD033R11E151KA01#	
			±20%	GMD033R11E151MA01#	
		180pF	±10%	GMD033R11E181KA01#	
			±20%	GMD033R11E181MA01#	
		220pF	±10%	GMD033R11E221KA01#	
			±20%	GMD033R11E221MA01#	
270pF		±10%	GMD033R11E271KA01#		
		±20%	GMD033R11E271MA01#		
330pF		±10%	GMD033R11E331KA01#		
		±20%	GMD033R11E331MA01#		
390pF		±10%	GMD033R11E391KA01#		
		±20%	GMD033R11E391MA01#		
470pF		±10%	GMD033R11E471KA01#		
		±20%	GMD033R11E471MA01#		
560pF		±10%	GMD033R11E561KA01#		
		±20%	GMD033R11E561MA01#		
680pF	±10%	GMD033R11E681KA01#			
	±20%	GMD033R11E681MA01#			

Rated Voltage	TC Code	Cap.	Tol.	Part Number		
25Vdc	R	820pF	±10%	GMD033R11E821KA01#		
			±20%	GMD033R11E821MA01#		
		1000pF	±10%	GMD033R11E102KA01#		
			±20%	GMD033R11E102MA01#		
		1200pF	±10%	GMD033R11E122KA01#		
			±20%	GMD033R11E122MA01#		
		1500pF	±10%	GMD033R11E152KA01#		
			±20%	GMD033R11E152MA01#		
		B	100pF	±10%	GMD033B11E101KA01#	
				±20%	GMD033B11E101MA01#	
			120pF	±10%	GMD033B11E121KA01#	
				±20%	GMD033B11E121MA01#	
			150pF	±10%	GMD033B11E151KA01#	
				±20%	GMD033B11E151MA01#	
			180pF	±10%	GMD033B11E181KA01#	
				±20%	GMD033B11E181MA01#	
			220pF	±10%	GMD033B11E221KA01#	
				±20%	GMD033B11E221MA01#	
			270pF	±10%	GMD033B11E271KA01#	
				±20%	GMD033B11E271MA01#	
	330pF		±10%	GMD033B11E331KA01#		
			±20%	GMD033B11E331MA01#		
	390pF		±10%	GMD033B11E391KA01#		
			±20%	GMD033B11E391MA01#		
	470pF		±10%	GMD033B11E471KA01#		
			±20%	GMD033B11E471MA01#		
	560pF		±10%	GMD033B11E561KA01#		
			±20%	GMD033B11E561MA01#		
	680pF	±10%	GMD033B11E681KA01#			
		±20%	GMD033B11E681MA01#			
	820pF	±10%	GMD033B11E821KA01#			
		±20%	GMD033B11E821MA01#			
	1000pF	±10%	GMD033B11E102KA01#			
		±20%	GMD033B11E102MA01#			
	1200pF	±10%	GMD033B11E122KA01#			
		±20%	GMD033B11E122MA01#			
	1500pF	±10%	GMD033B11E152KA01#			
		±20%	GMD033B11E152MA01#			
	16Vdc	X7R	1800pF	±10%	GMD033R71C182KA11#	
				±20%	GMD033R71C182MA11#	
2200pF			±10%	GMD033R71C222KA11#		
			±20%	GMD033R71C222MA11#		
2700pF			±10%	GMD033R71C272KA11#		
			±20%	GMD033R71C272MA11#		
3300pF			±10%	GMD033R71C332KA11#		
			±20%	GMD033R71C332MA11#		
R			1800pF	±10%	GMD033R11C182KA11#	
				±20%	GMD033R11C182MA11#	
		2200pF	±10%	GMD033R11C222KA11#		
			±20%	GMD033R11C222MA11#		
		2700pF	±10%	GMD033R11C272KA11#		
			±20%	GMD033R11C272MA11#		
		3300pF	±10%	GMD033R11C332KA11#		
			±20%	GMD033R11C332MA11#		

- GRM
- GR3
- GRJ
- GR4
- GJM
- GQM
- GA2
- GA3 GB
- GA3 GD
- GA3 GF
- LLL
- LLA
- LLM
- LLR
- NFM
- GJ4
- ZRA
- ZRB
- KRM
- KR3
- GMA
- GMD
- △Caution /Notice

Part number # indicates the package specification code.

GMD Series High Dielectric Constant Type Bonding Part Number List

(→ 0.6×0.3mm)

Rated Voltage	TC Code	Cap.	Tol.	Part Number	
16Vdc	B	1800pF	±10%	GMD033B31C182KA11#	
			±20%	GMD033B31C182MA11#	
		2200pF	±10%	GMD033B31C222KA11#	
			±20%	GMD033B31C222MA11#	
		2700pF	±10%	GMD033B31C272KA11#	
			±20%	GMD033B31C272MA11#	
	3300pF	±10%	GMD033B31C332KA11#		
		±20%	GMD033B31C332MA11#		
	10Vdc	X7R	3900pF	±10%	GMD033R71A392KA01#
				±20%	GMD033R71A392MA01#
			4700pF	±10%	GMD033R71A472KA01#
				±20%	GMD033R71A472MA01#
5600pF			±10%	GMD033R71A562KA01#	
			±20%	GMD033R71A562MA01#	
6800pF			±10%	GMD033R71A682KA01#	
			±20%	GMD033R71A682MA01#	
8200pF			±10%	GMD033R71A822KA01#	
			±20%	GMD033R71A822MA01#	
10000pF			±10%	GMD033R71A103KA01#	
			±20%	GMD033R71A103MA01#	
R		3900pF	±10%	GMD033R11A392KA01#	
			±20%	GMD033R11A392MA01#	
		4700pF	±10%	GMD033R11A472KA01#	
			±20%	GMD033R11A472MA01#	
		5600pF	±10%	GMD033R11A562KA01#	
			±20%	GMD033R11A562MA01#	
		6800pF	±10%	GMD033R11A682KA01#	
			±20%	GMD033R11A682MA01#	
		8200pF	±10%	GMD033R11A822KA01#	
			±20%	GMD033R11A822MA01#	
		10000pF	±10%	GMD033R11A103KA01#	
			±20%	GMD033R11A103MA01#	
X5R	3900pF	±10%	GMD033R61A392KA01#		
		±20%	GMD033R61A392MA01#		
	4700pF	±10%	GMD033R61A472KA01#		
		±20%	GMD033R61A472MA01#		
	5600pF	±10%	GMD033R61A562KA01#		
		±20%	GMD033R61A562MA01#		
	6800pF	±10%	GMD033R61A682KA01#		
		±20%	GMD033R61A682MA01#		
	8200pF	±10%	GMD033R61A822KA01#		
		±20%	GMD033R61A822MA01#		
	10000pF	±10%	GMD033R61A103KA01#		
		±20%	GMD033R61A103MA01#		
B	3900pF	±10%	GMD033B11A392KA01#		
		±20%	GMD033B11A392MA01#		
	4700pF	±10%	GMD033B11A472KA01#		
		±20%	GMD033B11A472MA01#		
	5600pF	±10%	GMD033B11A562KA01#		
		±20%	GMD033B11A562MA01#		
	6800pF	±10%	GMD033B11A682KA01#		
		±20%	GMD033B11A682MA01#		
	8200pF	±10%	GMD033B11A822KA01#		
		±20%	GMD033B11A822MA01#		

Rated Voltage	TC Code	Cap.	Tol.	Part Number
10Vdc	B	1000pF	±10%	GMD033B11A103KA01#
			±20%	GMD033B11A103MA01#
6.3Vdc	X5R	5600pF	±10%	GMD033R60J563KE11#
			±20%	GMD033R60J563ME11#
		6800pF	±10%	GMD033R60J683KE11#
			±20%	GMD033R60J683ME11#
		8200pF	±10%	GMD033R60J823KE11#
			±20%	GMD033R60J823ME11#
	B	0.10μF	±10%	GMD033R60J104KE11#
			±20%	GMD033R60J104ME11#
		5600pF	±10%	GMD033B30J563KE11#
			±20%	GMD033B30J563ME11#
		6800pF	±10%	GMD033B30J683KE11#
			±20%	GMD033B30J683ME11#
8200pF	±10%	GMD033B30J823KE11#		
	±20%	GMD033B30J823ME11#		
0.10μF	±10%	GMD033B30J104KE11#		
	±20%	GMD033B30J104ME11#		

1.0×0.5mm

Rated Voltage	TC Code	Cap.	Tol.	Part Number	
50Vdc	X7R	220pF	±10%	GMD155R71H221KA01#	
			±20%	GMD155R71H221MA01#	
		270pF	±10%	GMD155R71H271KA01#	
			±20%	GMD155R71H271MA01#	
		330pF	±10%	GMD155R71H331KA01#	
			±20%	GMD155R71H331MA01#	
		390pF	±10%	GMD155R71H391KA01#	
			±20%	GMD155R71H391MA01#	
		470pF	±10%	GMD155R71H471KA01#	
			±20%	GMD155R71H471MA01#	
		560pF	±10%	GMD155R71H561KA01#	
			±20%	GMD155R71H561MA01#	
		680pF	±10%	GMD155R71H681KA01#	
			±20%	GMD155R71H681MA01#	
		820pF	±10%	GMD155R71H821KA01#	
			±20%	GMD155R71H821MA01#	
		1000pF	±10%	GMD155R71H102KA01#	
			±20%	GMD155R71H102MA01#	
		1200pF	±10%	GMD155R71H122KA01#	
			±20%	GMD155R71H122MA01#	
		1500pF	±10%	GMD155R71H152KA01#	
			±20%	GMD155R71H152MA01#	
		1800pF	±10%	GMD155R71H182KA01#	
			±20%	GMD155R71H182MA01#	
		2200pF	±10%	GMD155R71H222KA01#	
			±20%	GMD155R71H222MA01#	
		2700pF	±10%	GMD155R71H272KA01#	
			±20%	GMD155R71H272MA01#	
		3300pF	±10%	GMD155R71H332KA01#	
			±20%	GMD155R71H332MA01#	
		3900pF	±10%	GMD155R71H392KA01#	
			±20%	GMD155R71H392MA01#	
		4700pF	±10%	GMD155R71H472KA01#	
			±20%	GMD155R71H472MA01#	
		R	220pF	±10%	GMD155R11H221KA01#
				±20%	GMD155R11H221MA01#
270pF	±10%		GMD155R11H271KA01#		
	±20%		GMD155R11H271MA01#		
330pF	±10%		GMD155R11H331KA01#		
	±20%		GMD155R11H331MA01#		

Part number # indicates the package specification code.

GRM
 GR3
 GRJ
 GR4
 GJM
 GQM
 GA2
 GA3 GB
 GA3 GD
 GA3 GF
 LLL
 LLA
 LLM
 LLR
 NFM
 GJ4
 ZRA
 ZRB
 KRM
 KR3
 GMA
 GMD
 ⚠Caution /Notice

GMD Series High Dielectric Constant Type Bonding Part Number List

(→ 1.0×0.5mm)

Rated Voltage	TC Code	Cap.	Tol.	Part Number	Rated Voltage	TC Code	Cap.	Tol.	Part Number
50Vdc	R	390pF	±10%	GMD155R11H391KA01#	25Vdc	X7R	1500pF	±10%	GMD155R71E153KA01#
			±20%	GMD155R11H471MA01#				±20%	GMD155R71E153MA01#
		470pF	±10%	GMD155R11H471KA01#			1800pF	±10%	GMD155R71E183KA01#
			±20%	GMD155R11H471MA01#				2200pF	±10%
		560pF	±10%	GMD155R11H561KA01#			2700pF		±10%
			±20%	GMD155R11H681MA01#				3300pF	±10%
		680pF	±10%	GMD155R11H681KA01#			3900pF		±10%
			±20%	GMD155R11H681MA01#				4700pF	±10%
		820pF	±10%	GMD155R11H821KA01#			5600pF		±10%
			±20%	GMD155R11H821MA01#				6800pF	±10%
		1000pF	±10%	GMD155R11H102KA01#			8200pF		±10%
			±20%	GMD155R11H102MA01#				10000pF	±10%
		1200pF	±10%	GMD155R11H122KA01#			12000pF		±10%
			±20%	GMD155R11H122MA01#				15000pF	±10%
		1500pF	±10%	GMD155R11H152KA01#			18000pF		±10%
			±20%	GMD155R11H152MA01#				22000pF	±10%
		1800pF	±10%	GMD155R11H182KA01#			27000pF		±10%
			±20%	GMD155R11H182MA01#				33000pF	±10%
		2200pF	±10%	GMD155R11H222KA01#			39000pF		±10%
			±20%	GMD155R11H222MA01#				47000pF	±10%
	2700pF	±10%	GMD155R11H272KA01#	5600pF	±10%	GMD155R11E473MA11#			
		±20%	GMD155R11H272MA01#		6800pF	±10%	GMD155R11E562KA01#		
	3300pF	±10%	GMD155R11H332KA01#	8200pF		±10%	GMD155R11E682KA01#		
		±20%	GMD155R11H332MA01#		10000pF	±10%	GMD155R11E682MA01#		
	3900pF	±10%	GMD155R11H392KA01#	12000pF		±10%	GMD155R11E822KA01#		
		±20%	GMD155R11H392MA01#		15000pF	±10%	GMD155R11E103KA01#		
	4700pF	±10%	GMD155R11H472KA01#	18000pF		±10%	GMD155R11E103MA01#		
		±20%	GMD155R11H472MA01#		22000pF	±10%	GMD155R11E123KA01#		
	B	220pF	±10%	GMD155B11H221KA01#		B	5600pF	±10%	GMD155B11E562KA01#
			±20%	GMD155B11H221MA01#	6800pF			±10%	GMD155B11E682KA01#
		270pF	±10%	GMD155B11H271KA01#			8200pF	±10%	GMD155B11E682MA01#
			±20%	GMD155B11H271MA01#	10000pF			±10%	GMD155B11E822KA01#
		330pF	±10%	GMD155B11H331KA01#			12000pF	±10%	GMD155B11E103KA01#
			±20%	GMD155B11H331MA01#	15000pF			±10%	GMD155B11E103MA01#
		390pF	±10%	GMD155B11H391KA01#			18000pF	±10%	GMD155B11E123KA01#
			±20%	GMD155B11H391MA01#	22000pF			±10%	GMD155B11E123MA01#
		470pF	±10%	GMD155B11H471KA01#			27000pF	±10%	GMD155B11E273KA11#
			±20%	GMD155B11H471MA01#	33000pF			±10%	GMD155B11E333KA11#
		560pF	±10%	GMD155B11H561KA01#			39000pF	±10%	GMD155B11E393KA11#
			±20%	GMD155B11H561MA01#	47000pF			±10%	GMD155B11E473KA11#
680pF		±10%	GMD155B11H681KA01#	5600pF			±10%	GMD155B11E473MA11#	
		±20%	GMD155B11H681MA01#		6800pF		±10%	GMD155B11E562KA01#	
820pF		±10%	GMD155B11H821KA01#	8200pF			±10%	GMD155B11E682KA01#	
		±20%	GMD155B11H821MA01#		10000pF		±10%	GMD155B11E682MA01#	
1000pF		±10%	GMD155B11H102KA01#	12000pF			±10%	GMD155B11E822KA01#	
		±20%	GMD155B11H102MA01#		15000pF		±10%	GMD155B11E103KA01#	
1200pF		±10%	GMD155B11H122KA01#	18000pF			±10%	GMD155B11E103MA01#	
		±20%	GMD155B11H122MA01#		22000pF		±10%	GMD155B11E123KA01#	
1500pF	±10%	GMD155B11H152KA01#	27000pF	±10%		GMD155B11E123MA01#			
	±20%	GMD155B11H152MA01#		33000pF	±10%	GMD155B31E273KA11#			
1800pF	±10%	GMD155B11H182KA01#	39000pF		±10%	GMD155B31E333KA11#			
	±20%	GMD155B11H182MA01#		47000pF	±10%	GMD155B31E333MA11#			
2200pF	±10%	GMD155B11H222KA01#	56000pF		±10%	GMD155B31E393KA11#			
	±20%	GMD155B11H222MA01#		68000pF	±10%	GMD155B31E473KA11#			
2700pF	±10%	GMD155B11H272KA01#	82000pF		±10%	GMD155B31E473MA11#			
	±20%	GMD155B11H272MA01#		100000pF	±10%	GMD155R71C563KA11#			
3300pF	±10%	GMD155B11H332KA01#	120000pF		±10%	GMD155R71C683KA11#			
	±20%	GMD155B11H332MA01#		±20%	GMD155R71C683MA11#				
3900pF	±10%	GMD155B11H392KA01#	150000pF	±10%	GMD155R71C823KA11#				
	±20%	GMD155B11H392MA01#		±10%	GMD155R71C104KA11#				
4700pF	±10%	GMD155B11H472KA01#	180000pF	±10%	GMD155R71C104MA11#				
	±20%	GMD155B11H472MA01#		±20%	GMD155R71C104MA11#				
25Vdc	X7R	5600pF	±10%	GMD155R71E562KA01#	16Vdc	X7R	5600pF	±10%	GMD155R71C563KA11#
			±20%	GMD155R71E562MA01#				6800pF	±10%
		8200pF	±10%	GMD155R71E822KA01#			8200pF		±10%
			±20%	GMD155R71E822MA01#				0.10μF	±10%
		10000pF	±10%	GMD155R71E103KA01#			12000pF		±10%
			±20%	GMD155R71E103MA01#				±20%	GMD155R71C104MA11#
12000pF	±10%	GMD155R71E123KA01#	15000pF	±10%	GMD155R11C563KA11#				
	±20%	GMD155R71E123MA01#							

Part number # indicates the package specification code.

GRM
GR3
GRJ
GR4
GJM
GQM
GA2
GA3 GB
GA3 GD
GA3 GF
LLL
LLA
LLM
LLR
NFM
GJ4
ZRA
ZRB
KRM
KR3
GMA
GMD
⚠Caution /Notice

GMD Series High Dielectric Constant Type Part Number List

(→ 1.0×0.5mm)

Rated Voltage	TC Code	Cap.	Tol.	Part Number		
16Vdc	R	68000pF	±10%	GMD155R11C683KA11#		
			±20%	GMD155R11C683MA11#		
		82000pF	±10%	GMD155R11C823KA11#		
			0.10μF	±10%	GMD155R11C104KA11#	
		±20%		GMD155R11C104MA11#		
		X5R	56000pF	±10%	GMD155R61C563KA11#	
				68000pF	±10%	GMD155R61C683KA11#
			±20%		GMD155R61C683MA11#	
	82000pF		±10%	GMD155R61C823KA11#		
			0.10μF	±10%	GMD155R61C104KA11#	
	±20%			GMD155R61C104MA11#		
	B		56000pF	±10%	GMD155B31C563KA11#	
				68000pF	±10%	GMD155B31C683KA11#
		±20%	GMD155B31C683MA11#			
		82000pF	±10%	GMD155B31C823KA11#		
			0.10μF	±10%	GMD155B31C104KA11#	
±20%		GMD155B31C104MA11#				
10Vdc		X5R	0.12μF	±10%	GMD155R61A124KE12#	
				0.15μF	±10%	GMD155R61A154KE12#
	±20%		GMD155R61A154ME12#			
	0.18μF		±10%	GMD155R61A184KE12#		
			0.22μF	±10%	GMD155R61A224KE12#	
	±20%			GMD155R61A224ME12#		
	0.27μF		±10%	GMD155R61A274KE11#	D1	
			0.33μF	±10%	GMD155R61A334KE11#	D1
	±20%			GMD155R61A334ME11#	D1	
	0.39μF		±10%	GMD155R61A394KE11#	D1	
			0.47μF	±10%	GMD155R61A474KE11#	D1
	±20%			GMD155R61A474ME11#	D1	
	B	0.12μF	±10%	GMD155B31A124KE12#		
			0.15μF	±10%	GMD155B31A154KE12#	
		±20%		GMD155B31A154ME12#		
		0.18μF	±10%	GMD155B31A184KE12#		
			0.22μF	±10%	GMD155B31A224KE12#	
		±20%		GMD155B31A224ME12#		
		0.27μF	±10%	GMD155B31A274KE11#	D1	
			0.33μF	±10%	GMD155B31A334KE11#	D1
		±20%		GMD155B31A334ME11#	D1	
		0.39μF	±10%	GMD155B31A394KE11#	D1	
			0.47μF	±10%	GMD155B31A474KE11#	D1
		±20%		GMD155B31A474ME11#	D1	
6.3Vdc	X5R	1.0μF	±10%	GMD155R60J105KE11#		
			±20%	GMD155R60J105ME11#		
	B	1.0μF	±10%	GMD155B30J105KE11#		
			±20%	GMD155B30J105ME11#		

- GRM
- GR3
- GRJ
- GR4
- GJM
- GQM
- GA2
- GA3 GB
- GA3 GD
- GA3 GF
- LLL
- LLA
- LLM
- LLR
- NFM
- GJ4
- ZRA
- ZRB
- KRM
- KR3
- GMA
- GMD
- ⚠Caution /Notice

⚠️Caution/Notice

WEB 

Target series: GRM, GR3, GRJ, GR4, GJM, GQM, GA2, GA3, LLL, LLA, LLM, LLR, NFM, GJ4, ZRA, ZRB, KRM, KR3, GMA, GMD

⚠️Caution

Notice

Storage and Operation Conditions	259
Rating	259
1. Temperature Dependent Characteristics	259
2. Measurement of Capacitance	259
3. Applied Voltage and Applied Current	260
4. Type of Applied Voltage and Self-heating Temperature	260
5. DC Voltage and AC Voltage Characteristics	263
6. Capacitance Aging	263
7. Vibration and Shock	264
Soldering and Mounting	264
1. Mounting Position	264
2. Information before Mounting	265
3. Maintenance of the Mounting (pick and place) Machine	265
4-1. Reflow Soldering	266
4-2. Flow Soldering	268
4-3. Correction of Soldered Portion	269
5. Washing	270
6. Electrical Test on Printed Circuit Board	270
7. Printed Circuit Board Cropping	270
8. Assembly	273
9. Die Bonding/Wire Bonding	274
Other	274
1. Under Operation of Equipment	274
2. Other	275

Rating	276
1. Operating Temperature	276
2. Atmosphere Surroundings (gaseous and liquid)	276
3. Piezo-electric Phenomenon	276
Soldering and Mounting	276
1. PCB Design	276
1. Notice for Pattern Forms	276
2. Land Dimensions	277
3. Board Design	281
2. Item to be confirmed for Flow soldering	281
3. Reflow Soldering	282
4. Washing	283
5. Coating	283
Other	283
1. Transportation	283
2. Characteristics Evaluation in the Actual System	283

GRM
 GR3
 GRJ
 GR4
 GJM
 GQM
 GA2
 GA3 GB
 GA3 GD
 GA3 GF
 LLL
 LLA
 LLM
 LLR
 NFM
 GJ4
 ZRA
 ZRB
 KRM
 KR3
 GMA
 GMD
 ⚠️Caution/Notice

Caution

Storage and Operation Conditions

1. The performance of chip multilayer ceramic capacitors and chip EMIFIL NFM series (henceforth just “capacitors”) may be affected by the storage conditions.

Please use them promptly after delivery.

1-1. Maintain appropriate storage for the capacitors using the following conditions: Room Temperature of +5 to +40°C and a Relative Humidity of 20 to 70%.

High temperature and humidity conditions and/or prolonged storage may cause deterioration of the packaging materials. If more than six months have elapsed since delivery, check packaging, mounting, etc. before use.

In addition, this may cause oxidation of the electrodes. If more than one year has elapsed since delivery, also check the solderability before use.

1-2. Corrosive gas can react with the termination (external) electrodes or lead wires of capacitors, and result in poor solderability. Do not store the capacitors in an atmosphere consisting of corrosive gas (e.g., hydrogen sulfide, sulfur dioxide, chlorine, ammonia gas, etc.).

1-3. Due to moisture condensation caused by rapid humidity changes, or the photochemical change caused by direct sunlight on the terminal electrodes and/or the resin/epoxy coatings, the solderability and electrical performance may deteriorate. Do not store capacitors under direct sunlight or in high humidity conditions.

<Applicable to GXM Series>

The water repellency of capacitor surface may reduce when the capacitor is exposed to high temperature for long periods of time. Be sure to confirm if the desired performance can be acquired in actual use conditions and the actual system.

Rating

1. Temperature Dependent Characteristics

1. The electrical characteristics of a capacitor can change with temperature.

1-1. For capacitors having larger temperature dependency, the capacitance may change with temperature changes.

The following actions are recommended in order to ensure suitable capacitance values.

(1) Select a suitable capacitance for the operating temperature range.

(2) The capacitance may change within the rated temperature.

When you use a high dielectric constant type capacitor in a circuit that needs a tight (narrow) capacitance tolerance (e.g., a time-constant circuit), please carefully consider the temperature characteristics, and carefully confirm the various characteristics in actual use conditions and the actual system.

[Example of Temperature Characteristics X7R (R7)]

Sample: 0.1μF, Rated Voltage 50VDC

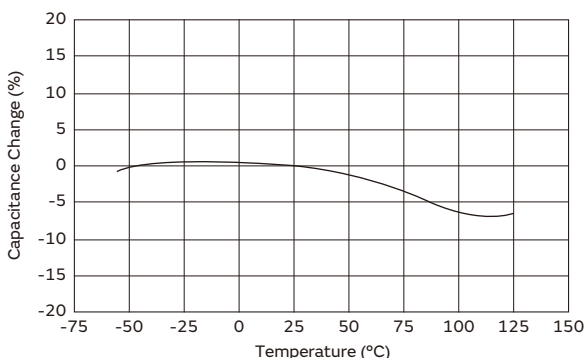

[Example of Temperature Characteristics X5R (R6)]

Sample: 22μF, Rated Voltage 4VDC

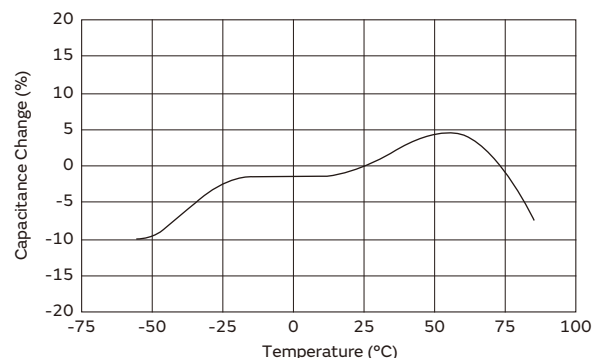

2. Measurement of Capacitance

1. Measure capacitance with the voltage and frequency specified in the product specifications.

1-1. The output voltage of the measuring equipment may decrease occasionally when capacitance is high. Please confirm whether a prescribed measured voltage is impressed to the capacitor.

1-2. The capacitance values of high dielectric constant type capacitors change depending on the AC voltage applied. Please consider the AC voltage characteristics when selecting a capacitor to be used in an AC circuit.

Continued on the following page. ↗

Caution

Continued from the preceding page. ↘

3. Applied Voltage and Applied Current

1. Do not apply a voltage to the capacitor that exceeds the rated voltage as called out in the specifications.
 - 1-1. Applied voltage between the terminals of a capacitor shall be less than or equal to the rated voltage.
 - (1) When AC voltage is superimposed on DC voltage, the zero-to-peak voltage shall not exceed the rated DC voltage.
 When AC voltage or pulse voltage is applied, the peak-to-peak voltage shall not exceed the rated DC voltage.
 - (2) Abnormal voltages (surge voltage, static electricity, pulse voltage, etc.) shall not exceed the rated DC voltage.

Typical Voltage Applied to the DC Capacitor

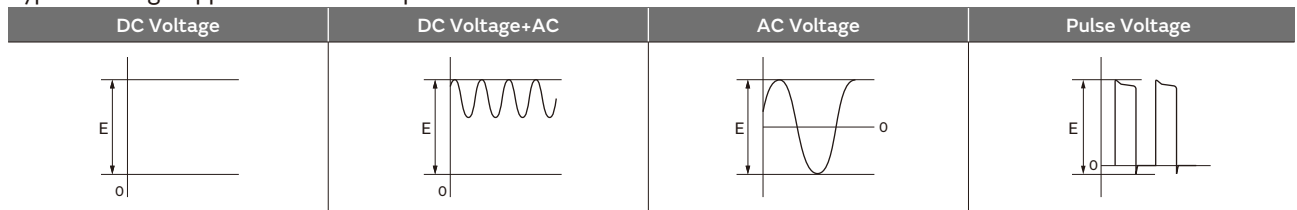

(E: Maximum possible applied voltage.)

- 1-2. Influence of over voltage
 Over voltage that is applied to the capacitor may result in an electrical short circuit caused by the breakdown of the internal dielectric layers. The time duration until breakdown depends on the applied voltage and the ambient temperature.
2. Use a safety standard certified capacitor in a power supply input circuit (AC filter), as it is also necessary to consider the withstand voltage and impulse withstand voltage defined for each device.

4. Type of Applied Voltage and Self-heating Temperature

1. Confirm the operating conditions to make sure that no large current is flowing into the capacitor due to the continuous application of an AC voltage or pulse voltage.
 When a DC rated voltage product is used in an AC voltage circuit or a pulse voltage circuit, the AC current or pulse current will flow into the capacitor; therefore check the self-heating condition.
 Please confirm the surface temperature of the capacitor so that the temperature remains within the upper limits of the operating temperature, including the rise in temperature due to self-heating. When the capacitor is used with a high-frequency voltage or pulse voltage, heat may be generated by dielectric loss.
<Applicable to Rated Voltage of less than 100VDC>
 - 1-1. The load should be contained so that the self-heating of the capacitor body remains below 20°C, when measuring at an ambient temperature of 25°C.

<Applicable to NFM Series>

3. The capacitors also have rated currents.
 The current flowing between the terminals of a capacitor shall be less than or equal to the rated current. Using the capacitor beyond this range could lead to excessive heat.

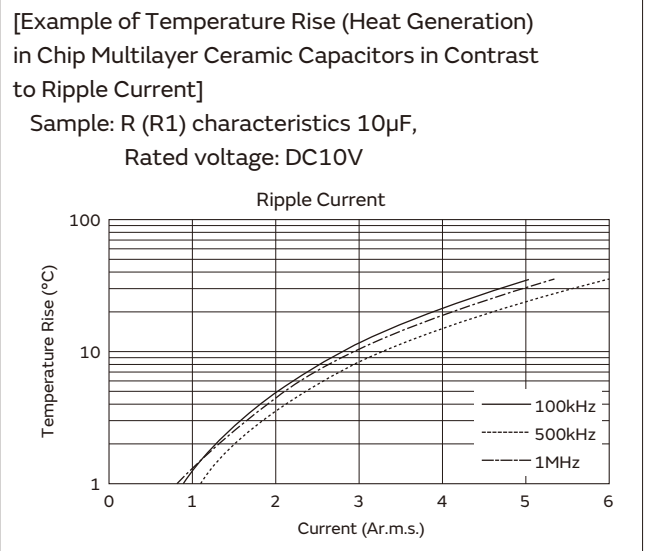

Continued on the following page. ↗

GRM
 GR3
 GRJ
 GR4
 GJM
 QOM
 GA2
 GA3 GB
 GA3 GD
 GA3 GF
 LLL
 LLA
 LLM
 LLR
 NFM
 GJ4
 ZRA
 ZRB
 KRM
 KR3
 GMA
 GMD
 △Caution

⚠Caution

Continued from the preceding page. ↘

<Applicable to Temperature Characteristics X7R (R7), X7T (D7), X7T (W0) beyond Rated Voltage of 200VDC>

1-2. The load should be contained so that the self-heating of the capacitor body remains below 20°C, when measuring at an ambient temperature of 25°C. In addition, use a K thermocouple of $\varnothing 0.1\text{mm}$ with less heat capacity when measuring, and measure in a condition where there is no effect from the radiant heat of other components or air flow caused by convection. Excessive generation of heat may cause deterioration of the characteristics and reliability of the capacitor. (Absolutely do not perform measurements while the cooling fan is operating, as an accurate measurement may not be performed.)

<Applicable to Temperature Characteristics U2J (7U), COG (5C) beyond Rated Voltage of 200VDC>

1-3. Since the self-heating is low in the low loss series, the allowable power becomes extremely high compared to the common X7R (R7) characteristics. However, when a load with self-heating of 20°C is applied at the rated voltage, the allowable power may be exceeded. When the capacitor is used in a high-frequency voltage circuit of 1kHz or more, the frequency of the applied voltage should be less than 500kHz sine wave (less than 100kHz for a product with rated voltage of DC3.15kV), to limit the voltage load so that the load remains within the derating shown in the following figure. In the case of non-sine wave, high-frequency components exceeding the fundamental frequency may be included. In such a case, please contact Murata. The excessive generation of heat may cause deterioration of the characteristics and reliability of the capacitor. (Absolutely do not perform measurements while the cooling fan is operating, as an accurate measurement may not be performed.)

[The sine-wave frequency VS allowable voltage]

The surface temperature of the capacitor: 125°C or less (including self-heating)

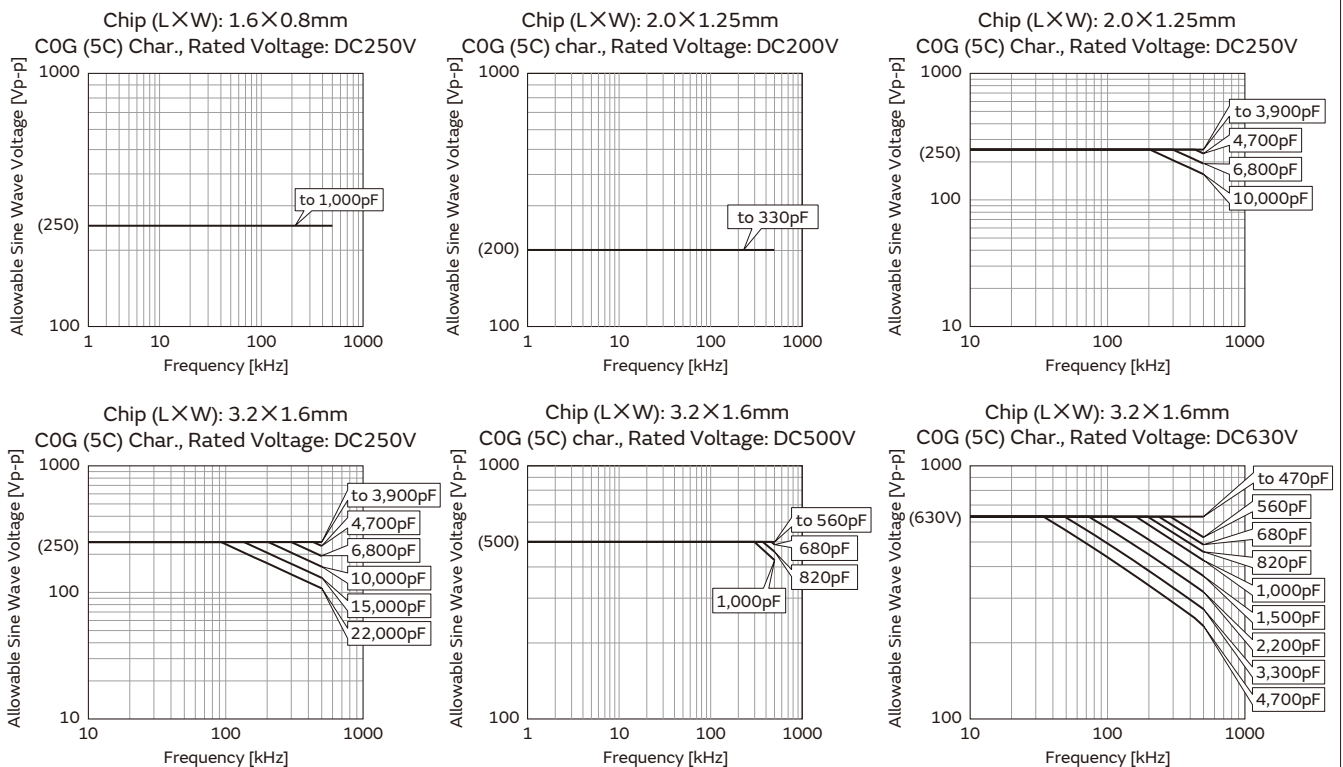

Continued on the following page. ↗

- GRM
- GR3
- GRJ
- GR4
- GJM
- GQM
- GA2
- GA3 GB
- GA3 GD
- GA3 GF
- LLL
- LLA
- LLM
- LLR
- NFM
- GJ4
- ZRA
- ZRB
- KRM
- KR3
- GMA
- GMD

⚠Caution

⚠Caution

Continued from the preceding page. ↘

[The sine-wave frequency VS allowable voltage]

The surface temperature of the capacitor: 125°C or less
 (including self-heating)

The capacitors less than 22pF can be applied maximum 4.0kV peak to peak at 100kHz or less only for the ballast or the resonance usage in the CFL inverter circuit.

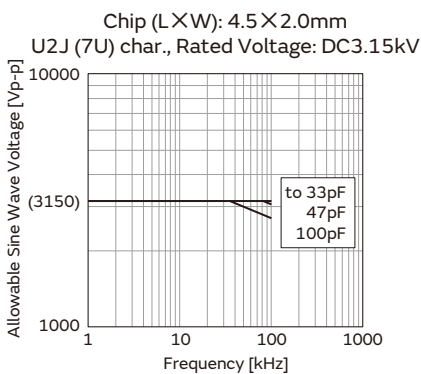
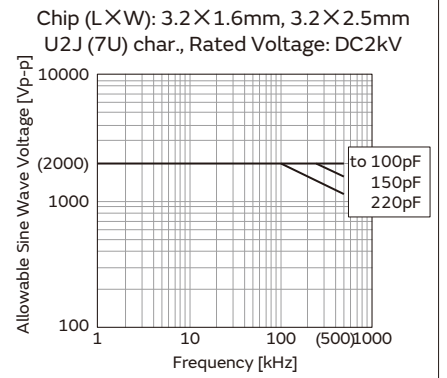
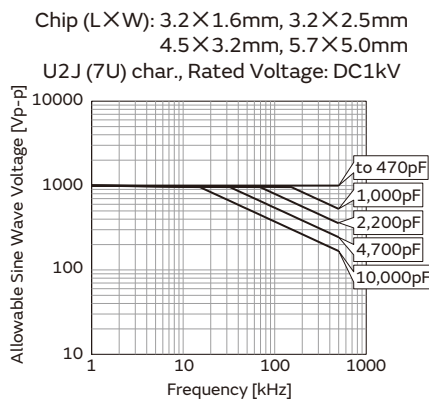
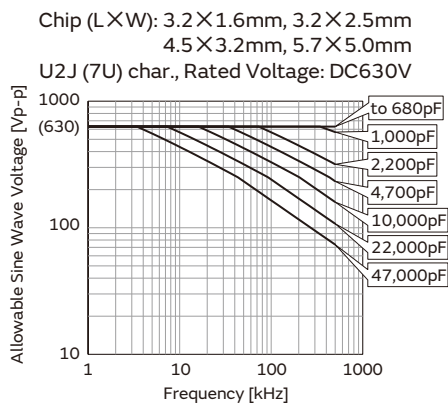
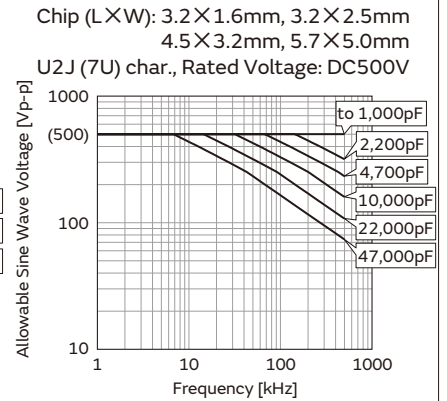
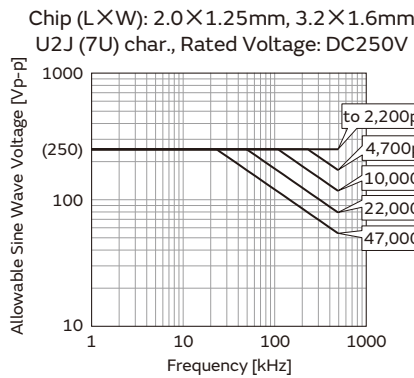
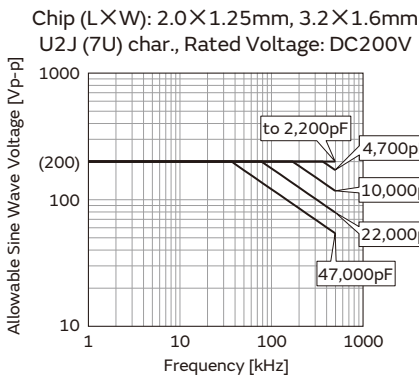
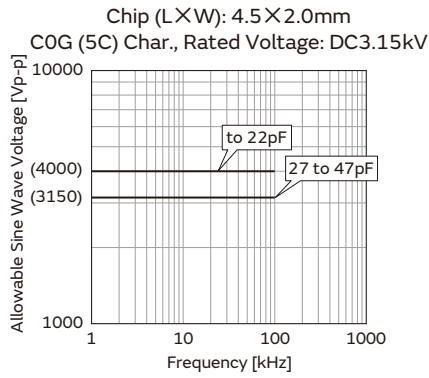
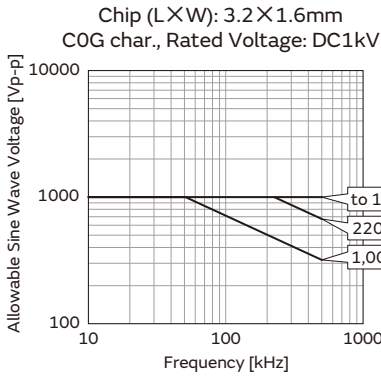

Continued on the following page. ↗

- GRM
- GR3
- GRJ
- GR4
- GJM
- GQM
- GA2
- GA3 GB
- GA3 GD
- GA3 GF
- LLL
- LLA
- LLM
- LLR
- NFM
- GJ4
- ZRA
- ZRB
- KRM
- KR3
- GMA
- GMD

⚠Caution

⚠Caution

Continued from the preceding page. ↘

5. DC Voltage and AC Voltage Characteristics

1. The capacitance value of a high dielectric constant type capacitor changes depending on the DC voltage applied. Please consider the DC voltage characteristics when a capacitor is selected for use in a DC circuit.

1-1. The capacitance of ceramic capacitors may change sharply depending on the applied voltage (see figure). Please confirm the following in order to secure the capacitance.

- (1) Determine whether the capacitance change caused by the applied voltage is within the allowed range.
- (2) In the DC voltage characteristics, the rate of capacitance change becomes larger as voltage increases, even if the applied voltage is below the rated voltage. When a high dielectric constant type capacitor is used in a circuit that requires a tight (narrow) capacitance tolerance (e.g., a time constant circuit), please carefully consider the voltage characteristics, and confirm the various characteristics in the actual operating conditions of the system.

2. The capacitance values of high dielectric constant type capacitors changes depending on the AC voltage applied. Please consider the AC voltage characteristics when selecting a capacitor to be used in an AC circuit.

[Example of DC Voltage Characteristics]
 Sample: X7R (R7) Characteristics 0.1μF,
 Rated Voltage 50VDC

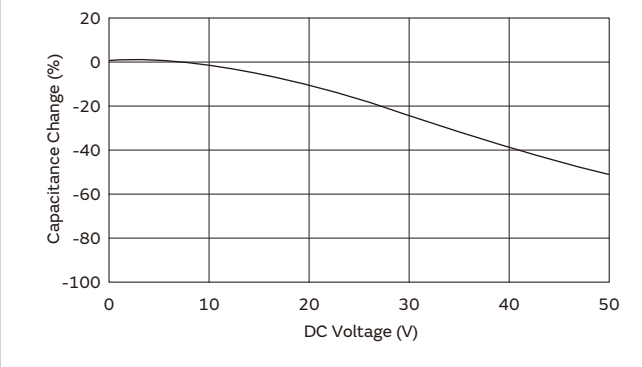

[Example of AC Voltage Characteristics]
 Sample: X7R (R7) Characteristics 10μF,
 Rated Voltage 6.3VDC

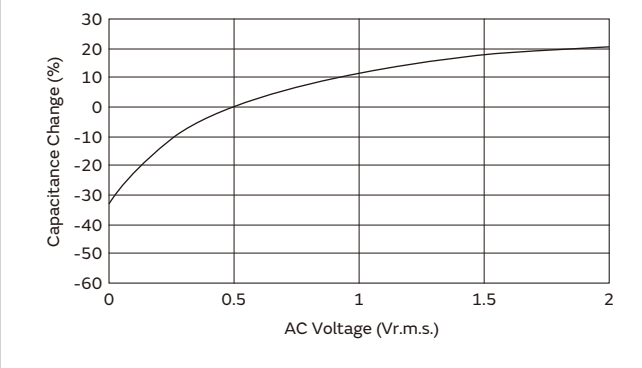

6. Capacitance Aging

1. The high dielectric constant type capacitors have an Aging characteristic in which the capacitance value decreases with the passage of time. When you use high dielectric constant type capacitors in a circuit that needs a tight (narrow) capacitance tolerance (e.g., a time-constant circuit), please carefully consider the characteristics of these capacitors, such as their aging, voltage, and temperature characteristics. In addition, check capacitors using your actual appliances at the intended environment and operating conditions.

[Example of Change Over Time (Aging Characteristics)]

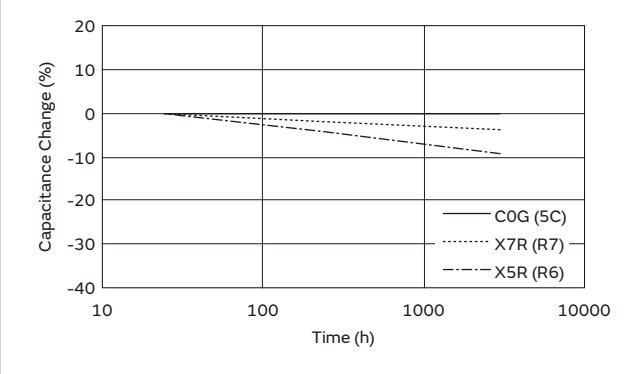

Continued on the following page. ↗

- GRM
- GR3
- GRJ
- GR4
- GJM
- GQM
- GA2
- GA3 GB
- GA3 GD
- GA3 GF
- LLL
- LLA
- LLM
- LLR
- NFM
- GJ4
- ZRA
- ZRB
- KRM
- KR3
- GMA
- GMD
- ⚠Caution

⚠Caution

Continued from the preceding page. ↘

7. Vibration and Shock

1. Please confirm the kind of vibration and/or shock, its condition, and any generation of resonance.
 Please mount the capacitor so as not to generate resonance, and do not allow any impact on the terminals.
2. Mechanical shock due to being dropped may cause damage or a crack in the dielectric material of the capacitor.
 Do not use a dropped capacitor because the quality and reliability may be deteriorated.
3. When printed circuit boards are piled up or handled, the corner of another printed circuit board should not be allowed to hit the capacitor, in order to avoid a crack or other damage to the capacitor.

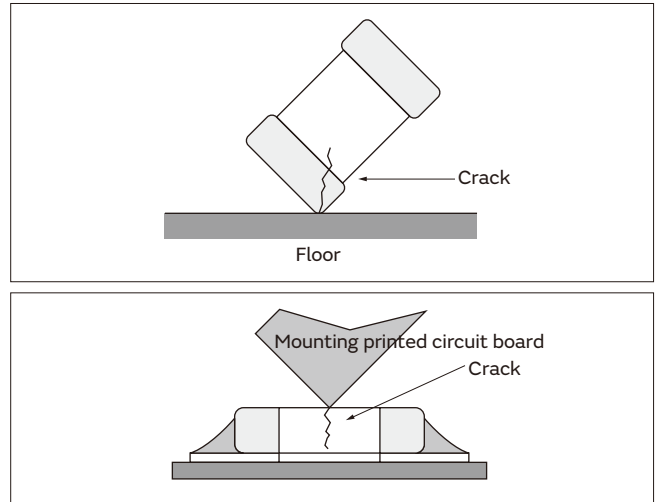

Soldering and Mounting

1. Mounting Position

1. Confirm the best mounting position and direction that minimizes the stress imposed on the capacitor during flexing or bending the printed circuit board.
 - 1-1. Choose a mounting position that minimizes the stress imposed on the chip during flexing or bending of the board.

<Applicable to NFM Series>

2. If you mount the capacitor near components that generate heat, take note of the heat from the other components and carefully check the self-heating of the capacitor before using.
 If there is significant heat radiation from other components, it could lower the insulation resistance of the capacitor or produce excessive heat.

[Component Direction]

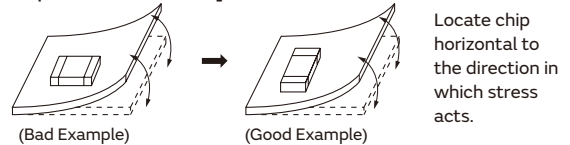

[Chip Mounting Close to Board Separation Point]

It is effective to implement the following measures, to reduce stress in separating the board.

It is best to implement all of the following three measures; however, implement as many measures as possible to reduce stress.

Contents of Measures	Stress Level
(1) Turn the mounting direction of the component parallel to the board separation surface.	A > D *1
(2) Add slits in the board separation part.	A > B
(3) Keep the mounting position of the component away from the board separation surface.	A > C

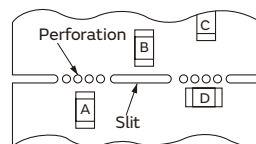

*1 A > D is valid when stress is added vertically to the perforation as with Hand Separation.
 If a Cutting Disc is used, stress will be diagonal to the PCB, therefore A > D is invalid.

[Mounting Capacitors Near Screw Holes]

When a capacitor is mounted near a screw hole, it may be affected by the board deflection that occurs during the tightening of the screw. Mount the capacitor in a position as far away from the screw holes as possible.

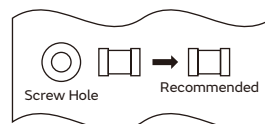

Continued on the following page. ↗

GRM
 GR3
 GRJ
 GR4
 GJM
 GQM
 GA2
 GA3 GB
 GA3 GD
 GA3 GF
 LLL
 LLA
 LLM
 LLR
 NFM
 GJ4
 ZRA
 ZRB
 KRM
 KR3
 GMA
 GMD
 ⚠Caution

⚠Caution

Continued from the preceding page. ↘

2. Information before Mounting

1. Do not re-use capacitors that were removed from the equipment.
2. Confirm capacitance characteristics under actual applied voltage.
3. Confirm the mechanical stress under actual process and equipment use.
4. Confirm the rated capacitance, rated voltage and other electrical characteristics before assembly.
5. Prior to use, confirm the solderability of capacitors that were in long-term storage.
6. Prior to measuring capacitance, carry out a heat treatment for capacitors that were in long-term storage.
7. The use of Sn-Zn based solder will deteriorate the reliability of the MLCC.
Please contact our sales representative or product engineers on the use of Sn-Zn based solder in advance.

3. Maintenance of the Mounting (pick and place) Machine

1. Make sure that the following excessive forces are not applied to the capacitors. Check the mounting in the actual device under actual use conditions ahead of time.
 - 1-1. In mounting the capacitors on the printed circuit board, any bending force against them shall be kept to a minimum to prevent them from any damage or cracking. Please take into account the following precautions and recommendations for use in your process.
 - (1) Adjust the lowest position of the pickup nozzle so as not to bend the printed circuit board.
2. Dirt particles and dust accumulated in the suction nozzle and suction mechanism prevent the nozzle from moving smoothly. This creates excessive force on the capacitor during mounting, causing cracked chips. Also, the locating claw, when worn out, imposes uneven forces on the chip when positioning, causing cracked chips. The suction nozzle and the locating claw must be maintained, checked, and replaced periodically.

<Applicable to ZRA/ZRB Series>

3. To adjust the inspection tolerance for automated appearance sorting machine of mounting position, because ZRA/ZRB series are easier to shift the mounting position than standard MLCC.
4. To check the overturn and reverse of chip.
5. To control mounting speed carefully, because ZRA/ZRB series is heavier than standard MLCC.

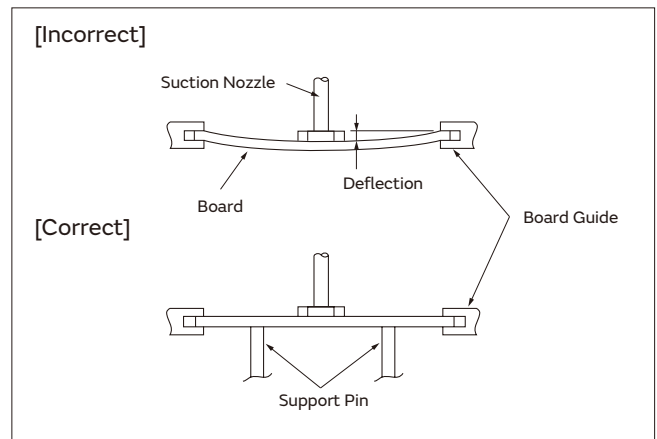

Continued on the following page. ↗

GRM

GR3

GRJ

GR4

GJM

GQM

GA2

GA3
GB

GA3
GD

GA3
GF

LLL

LLA

LLM

LLR

NFM

GJ4

ZRA

ZRB

KRM

KR3

GMA

GMD

△Caution

265

⚠Caution

Continued from the preceding page. ↘

4-1. Reflow Soldering

1. When sudden heat is applied to the components, the mechanical strength of the components will decrease because a sudden temperature change causes deformation inside the components. In order to prevent mechanical damage to the components, preheating is required for both the components and the PCB. Preheating conditions are shown in table 1. It is required to keep the temperature differential between the solder and the components surface (ΔT) as small as possible.
2. When components are immersed in solvent after mounting, be sure to maintain the temperature difference (ΔT) between the component and the solvent within the range shown in table 1.

Table 1

Series	Chip Dimension Code (L/W)	Temperature Differential
GRM/GRJ/GXM/GR4/GJM/GQM/LLR/NFM/GJ4/ZRA/ZRB/KRM	01/02/MD/03/15/18/JN/21/31	$\Delta T \leq 190^\circ\text{C}$
LLL	02/03/15/18/1U/21/31	
GRM/GR3/GRJ/GXM/GR4/GA2/GA3/KRM/KR3	32/42/43/52/55	$\Delta T \leq 130^\circ\text{C}$
LLA/LLM	18/21/31	
GQM	22	

Recommended Conditions

	Pb-Sn Solder	Lead Free Solder
Peak Temperature	230 to 250°C	240 to 260°C
Atmosphere	Air	Air or N ₂

Pb-Sn Solder: Sn-37Pb
 Lead Free Solder: Sn-3.0Ag-0.5Cu

3. When a capacitor is mounted at a temperature lower than the peak reflow temperature recommended by the solder manufacturer, the following quality problems can occur. Consider factors such as the placement of peripheral components and the reflow temperature setting to prevent the capacitor's reflow temperature from dropping below the peak temperature specified. Be sure to evaluate the mounting situation beforehand and verify that none of the following problems occur.
 - Drop in solder wettability
 - Solder voids
 - Possible occurrence of whiskering
 - Drop in bonding strength
 - Drop in self-alignment properties
 - Possible occurrence of tombstones and/or shifting on the land patterns of the circuit board

[Example of Temperature Conditions for Reflow Soldering]

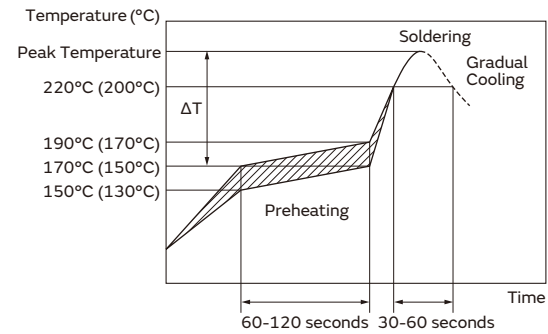

Temperature
 Incase of Lead Free Solder
 (): In case of Pb-Sn Solder

[Allowable Reflow Soldering Temperature and Time]

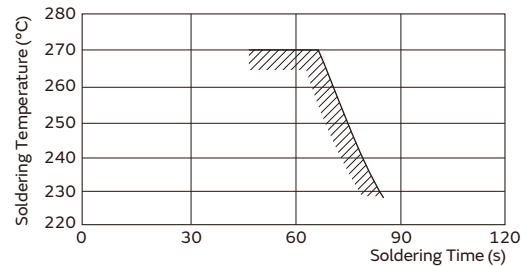

In the case of repeated soldering, the accumulated soldering time must be within the range shown above.

Continued on the following page. ↗

- GRM
- GR3
- GRJ
- GR4
- GJM
- GQM
- GA2
- GA3 GB
- GA3 GD
- GA3 GF
- LLL
- LLA
- LLM
- LLR
- NFM
- GJ4
- ZRA
- ZRB
- KRM
- KR3
- GMA
- GMD
- ⚠Caution

⚠️Caution

Continued from the preceding page. ↘

4. Optimum Solder Amount for Reflow Soldering

- 4-1. Overly thick application of solder paste results in a excessive solder fillet height.
 This makes the chip more susceptible to mechanical and thermal stress on the board and may cause the chips to crack.
- 4-2. Too little solder paste results in a lack of adhesive strength on the termination, which may result in chips breaking loose from the PCB.
- 4-3. Please confirm that solder has been applied smoothly to the termination. (Only ZRA/ZRB Series: The solder applied to the end surface of chip may cause loss suppress acoustic noise.)

<Applicable to NFM Series>

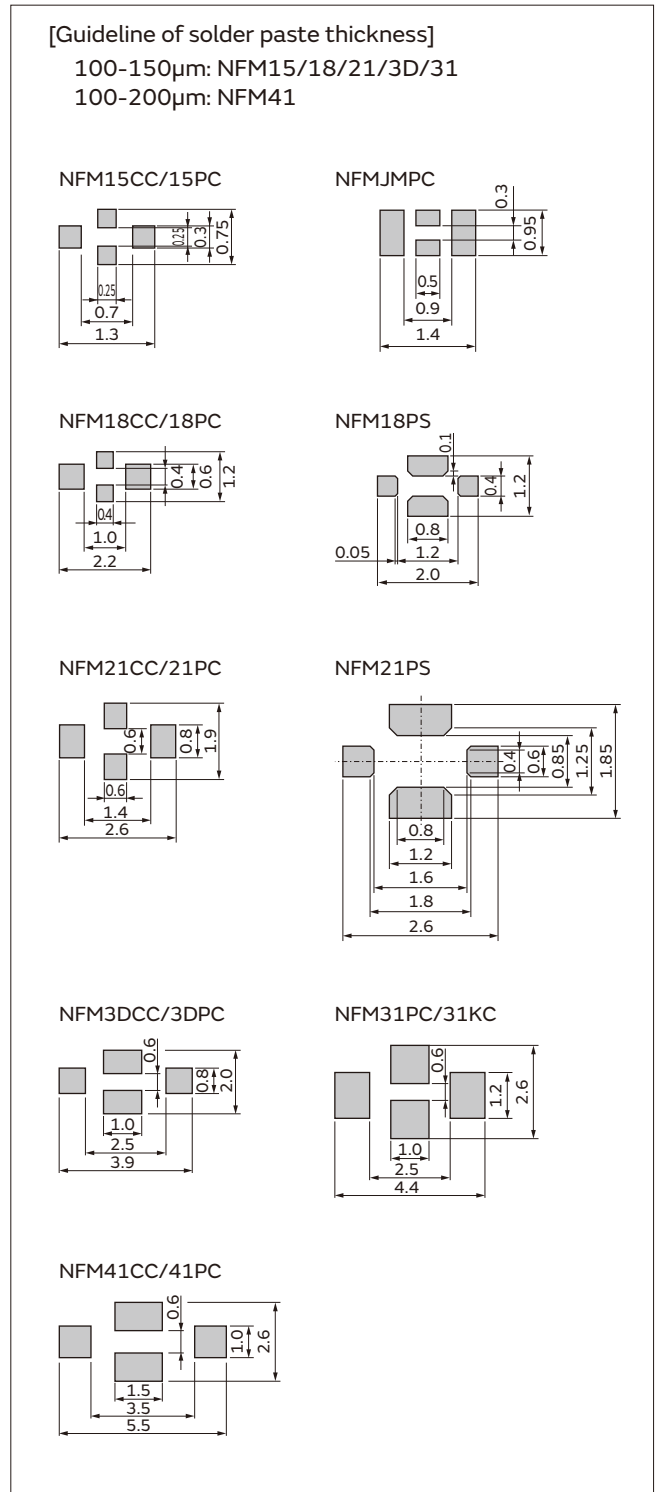

Inverting the PCB

Make sure not to impose any abnormal mechanical shocks to the PCB.

Continued on the following page. ↗

- GRM
- GR3
- GRJ
- GR4
- GJM
- GQM
- GA2
- GA3 GB
- GA3 GD
- GA3 GF
- LLL
- LLA
- LLM
- LLR
- NFM
- GJ4
- ZRA
- ZRB
- KPM
- KR3
- GMA
- GMD
- ⚠️Caution

⚠Caution

Continued from the preceding page. ↘

4-2. Flow Soldering

1. Do not apply flow soldering to chips not listed in table 2.

Table 2

Series	Chip Dimension Code (L/W)	Temperature Differential
GRM	18/21/31	$\Delta T \leq 150^\circ\text{C}$
GQM	18/21	
LLL	21/31	
GRJ	18/21/31	
NFM	3D/31/41	

- When sudden heat is applied to the components, the mechanical strength of the components will decrease because a sudden temperature change causes deformation inside the components. In order to prevent mechanical damage to the components, preheating is required for both of the components and the PCB. Preheating conditions are shown in table 2. It is required to keep the temperature differential between the solder and the components surface (ΔT) as low as possible.
- Excessively long soldering time or high soldering temperature can result in leaching of the terminations, causing poor adhesion or a reduction in capacitance value due to loss of contact between the inner electrodes and terminations.
- When components are immersed in solvent after mounting, be sure to maintain the temperature differential (ΔT) between the component and solvent within the range shown in the table 2.

Recommended Conditions

	Pb-Sn Solder	Lead Free Solder
Preheating Peak Temperature	90 to 110°C	100 to 120°C 140 to 160°C (NFM)
Soldering Peak Temperature	240 to 250°C	250 to 260°C
Atmosphere	Air	Air or N ₂

Pb-Sn Solder: Sn-37Pb

Lead Free Solder: Sn-3.0Ag-0.5Cu

5. Optimum Solder Amount for Flow Soldering

5-1. The top of the solder fillet should be lower than the thickness of the components. If the solder amount is excessive, the risk of cracking is higher during board bending or any other stressful condition.

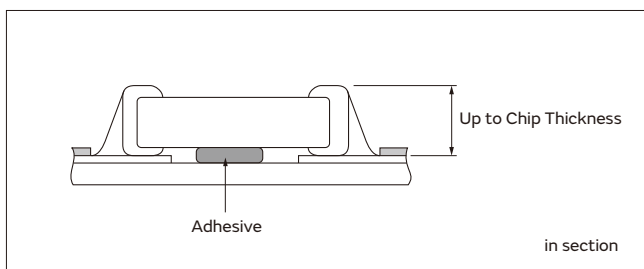

[Example of Temperature Conditions for Flow Soldering]

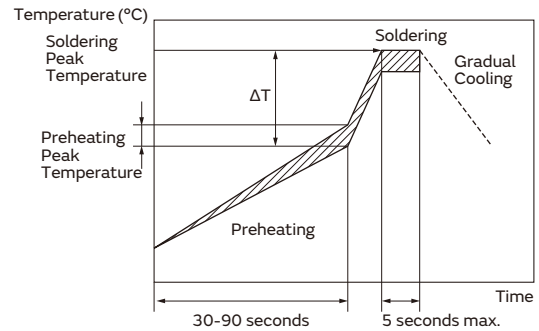

[Allowable Flow Soldering Temperature and Time]

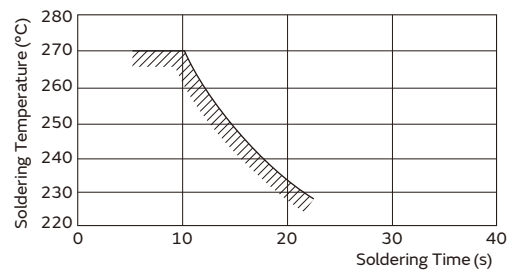

In the case of repeated soldering, the accumulated soldering time must be within the range shown above.

Continued on the following page. ↗

- GRM
- GR3
- GRJ
- GR4
- GJM
- GQM
- GA2
- GA3 GB
- GA3 GD
- GA3 GF
- LLL
- LLA
- LLM
- LLR
- NFM
- GJ4
- ZRA
- ZRB
- KRM
- KR3
- GMA
- GMD
- ⚠Caution

⚠Caution

Continued from the preceding page. ↘

4-3. Correction of Soldered Portion

When sudden heat is applied to the capacitor, distortion caused by the large temperature difference occurs internally, and can be the cause of cracks. Capacitors also tend to be affected by mechanical and thermal stress depending on the board preheating temperature or the soldering fillet shape, and can be the cause of cracks. Please refer to "1. PCB Design" or "3. Optimum solder amount" for the solder amount and the fillet shapes.

Do not correct with a soldering iron for ZRA/ZRB series. Correction with a soldering iron for ZRA/ZRB series may cause loss suppress acoustic noise, because the solder amount become excessive.

1. Correction with a Soldering Iron

- 1-1. In order to reduce damage to the capacitor, be sure to preheat the capacitor and the mounting board. Preheat to the temperature range shown in Table 3. A hot plate, hot air type preheater, etc. can be used for preheating.
- 1-2. After soldering, do not allow the component/PCB to cool down rapidly.
- 1-3. Perform the corrections with a soldering iron as quickly as possible. If the soldering iron is applied too long, there is a possibility of causing solder leaching on the terminal electrodes, which will cause deterioration of the adhesive strength and other problems.

Table 3

Series	Chip Dimension Code (L/W)	Temperature of Soldering Iron Tip	Preheating Temperature	Temperature Differential (ΔT)	Atmosphere
GRM/GRJ/GXM/GJM/GQM/GJ4	03/15/18/JN/21/31	350°C max.	150°C min.	ΔT≤190°C	Air
GRM/GRJ/GXM/GR4/GA2/GA3	32/42/43/52/55	280°C max.	150°C min.	ΔT≤130°C	Air
GQM	22				
NFM	18/21/3D/31/41	350°C max.	150°C min.	ΔT≤190°C	Air
	15	340°C max.			

*Applicable for both Pb-Sn and Lead Free Solder.
 Pb-Sn Solder: Sn-37Pb
 Lead Free Solder: Sn-3.0Ag-0.5Cu
 *Please manage ΔT in the temperature of soldering iron and the preheating temperature.
 * Please do not rework with soldering iron for NFMJM series due to cracking concern.

2. Correction with Spot Heater

Compared to local heating with a soldering iron, hot air heating by a spot heater heats the overall component and board, therefore, it tends to lessen the thermal shock. In the case of a high density mounted board, a spot heater can also prevent concerns of the soldering iron making direct contact with the component.

- 2-1. If the distance from the hot air outlet of the spot heater to the component is too close, cracks may occur due to thermal shock. To prevent this problem, follow the conditions shown in Table 4.
- 2-2. In order to create an appropriate solder fillet shape, it is recommended that hot air be applied at the angle shown in Figure 1.

Table 4

Distance	5mm or more
Hot Air Application Angle	45° *Figure 1
Hot Air Temperature Nozzle Outlet	400°C max.
Application Time	Less than 10 seconds (Chip (L×W): 3.2×1.6mm or smaller)
	Less than 30 seconds (Chip (L×W): 3.2×2.5mm or larger)

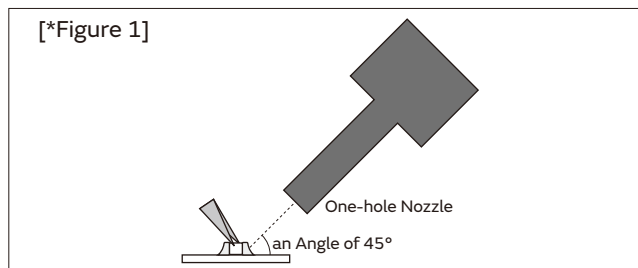

3. Optimum solder amount when re-working with a soldering iron

- 3-1. If the solder amount is excessive, the risk of cracking is higher during board bending or any other stressful condition. Too little solder amount results in a lack of adhesive strength on the termination, which may result in chips breaking loose from the PCB. Please confirm that solder has been applied smoothly and rising to the end surface of the chip.

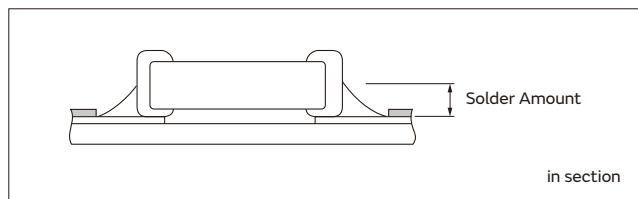

Continued on the following page. ↗

GRM
 GR3
 GRJ
 GR4
 GJM
 GQM
 GA2
 GA3 GB
 GA3 GD
 GA3 GF
 LLL
 LLA
 LLM
 LLR
 NFM
 GJ4
 ZRA
 ZRB
 KRM
 KR3
 GMA
 GMD
 ⚠Caution

⚠Caution

Continued from the preceding page. ↘

- 3-2. A soldering iron with a tip of $\varnothing 3\text{mm}$ or smaller should be used. It is also necessary to keep the soldering iron from touching the components during the re-work.
- 3-3. Solder wire with $\varnothing 0.5\text{mm}$ or smaller is required for soldering.

<Applicable to KR3/KRM Series>

4. For the shape of the soldering iron tip, refer to the figure on the right.

Regarding the type of solder, use a wire diameter of $\varnothing 0.5\text{mm}$ or less (rosin core wire solder).

4-1. How to Apply the Soldering Iron

Apply the tip of the soldering iron against the lower end of the metal terminal.

- 1) In order to prevent cracking caused by sudden heating of the ceramic device, do not touch the ceramic base directly.
- 2) In order to prevent deviations and dislocating of the chip, do not touch the junction of the chip and the metal terminal, and the metal portion on the outside directly.

4-2. Appropriate Amount of Solder

The amount of solder for corrections by soldering iron, should be lower than the height of the lower side of the chip.

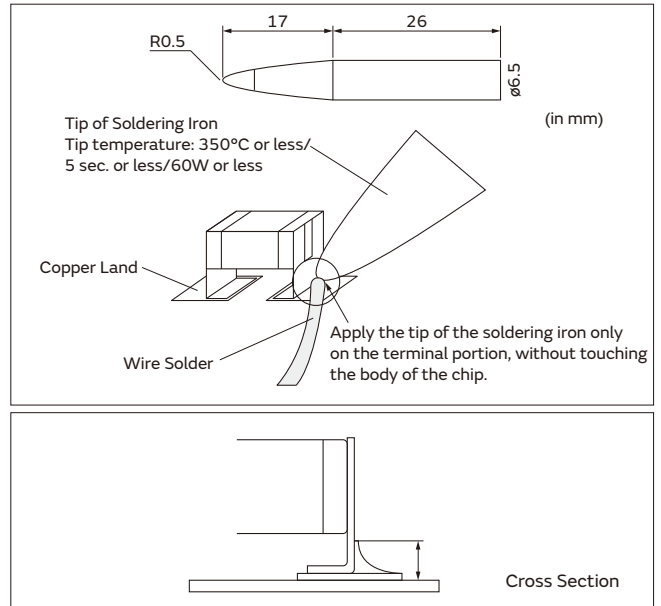

5. Washing

Excessive ultrasonic oscillation during cleaning can cause the PCBs to resonate, resulting in cracked chips or broken solder joints. Before starting your production process, test your cleaning equipment/process to insure it does not degrade the capacitors.

6. Electrical Test on Printed Circuit Board

1. Confirm position of the support pin or specific jig, when inspecting the electrical performance of a capacitor after mounting on the printed circuit board.

1-1. Avoid bending the printed circuit board by the pressure of a test-probe, etc.

The thrusting force of the test probe can flex the PCB, resulting in cracked chips or open solder joints. Provide support pins on the back side of the PCB to prevent warping or flexing. Install support pins as close to the test-probe as possible.

1-2. Avoid vibration of the board by shock when a test-probe contacts a printed circuit board.

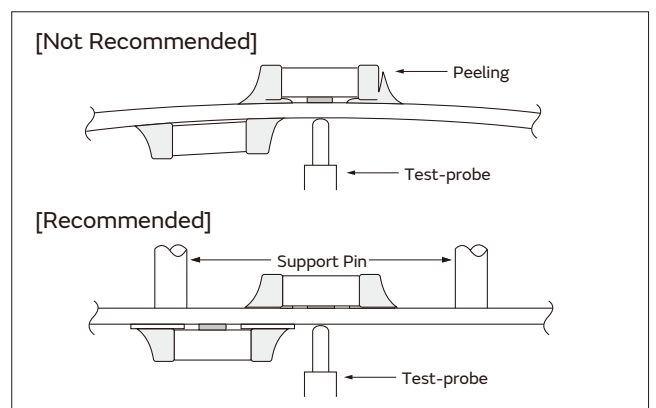

7. Printed Circuit Board Cropping

1. After mounting a capacitor on a printed circuit board, do not apply any stress to the capacitor that causes bending or twisting the board.

- 1-1. In cropping the board, the stress as shown at right may cause the capacitor to crack. Cracked capacitors may cause deterioration of the insulation resistance, and result in a short. Avoid this type of stress to a capacitor.

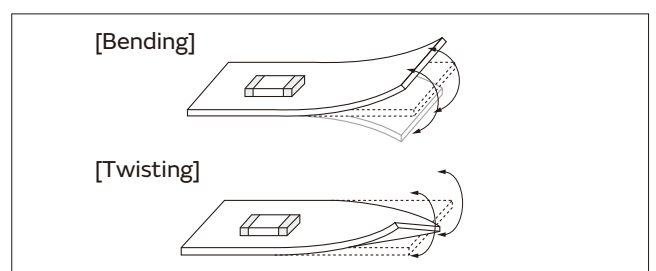

Continued on the following page. ↗

GRM
 GR3
 GRJ
 GR4
 GJM
 GQM
 GA2
 GA3 GB
 GA3 GD
 GA3 GF
 LLL
 LLA
 LLM
 LLR
 NFM
 GJ4
 ZRA
 ZRB
 KRM
 KR3
 GMA
 GMD
 ⚠Caution

⚠Caution

Continued from the preceding page. ↘

2. Check the cropping method for the printed circuit board in advance.

2-1. Printed circuit board cropping shall be carried out by using a jig or an apparatus (Disc separator, router type separator, etc.) to prevent the mechanical stress that can occur to the board.

Board Separation Method	Hand Separation Nipper Separation	(1) Board Separation Jig	Board Separation Apparatus	
			(2) Disc Separator	(3) Router Type Separator
Level of stress on board	High	Medium	Medium	Low
Recommended	×	△*	△*	○
Notes	Hand and nipper separation apply a high level of stress. Use another method.	<ul style="list-style-type: none"> Board handling Board bending direction Layout of capacitors 	<ul style="list-style-type: none"> Board handling Layout of slits Design of V groove Arrangement of blades Controlling blade life 	Board handling

* When a board separation jig or disc separator is used, if the following precautions are not observed, a large board deflection stress will occur and the capacitors may crack. Use router type separator if at all possible.

(1) Example of a suitable jig

[In the case of Single-side Mounting]

An outline of the board separation jig is shown as follows. Recommended example: Stress on the component mounting position can be minimized by holding the portion close to the jig, and bend in the direction towards the side where the capacitors are mounted. Not recommended example: The risk of cracks occurring in the capacitors increases due to large stress being applied to the component mounting position, if the portion away from the jig is held and bent in the direction opposite the side where the capacitors are mounted.

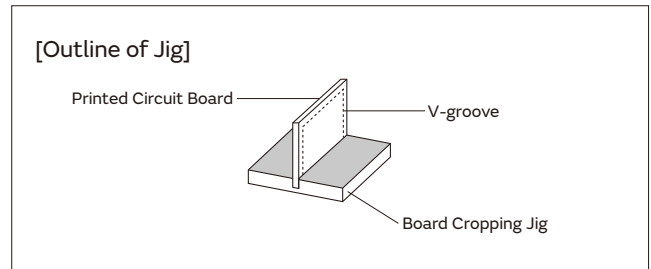

Hand Separation

Recommended	Not Recommended

[In the case of Double-sided Mounting]

Since components are mounted on both sides of the board, the risk of cracks occurring can not be avoided with the above method. Therefore, implement the following measures to prevent stress from being applied to the components.

(Measures)

- (1) Consider introducing a router type separator. If it is difficult to introduce a router type separator, implement the following measures. (Refer to item 1. Mounting Position)
- (2) Mount the components parallel to the board separation surface.
- (3) When mounting components near the board separation point, add slits in the separation position near the component.
- (4) Keep the mounting position of the components away from the board separation point.

Continued on the following page. ↗

GRM
GR3
GRJ
GR4
GJM
GQM
GA2
GA3 GB
GA3 GD
GA3 GF
LLL
LLA
LLM
LLR
NFM
GJ4
ZRA
ZRB
KRM
KR3
GMA
GMD
⚠Caution

⚠Caution

Continued from the preceding page. ↘

(2) Example of a Disc Separator

An outline of a disc separator is shown as follows. As shown in the Principle of Operation, the top blade and bottom blade are aligned with the V-grooves on the printed circuit board to separate the board.

In the following case, board deflection stress will be applied and cause cracks in the capacitors.

- (1) When the adjustment of the top and bottom blades are misaligned, such as deviating in the top-bottom, left-right or front-rear directions
- (2) The angle of the V groove is too low, depth of the V groove is too shallow, or the V groove is misaligned top-bottom

IF V groove is too deep, it is possible to brake when you handle and carry it. Carefully design depth of the V groove with consideration about strength of material of the printed circuit board.

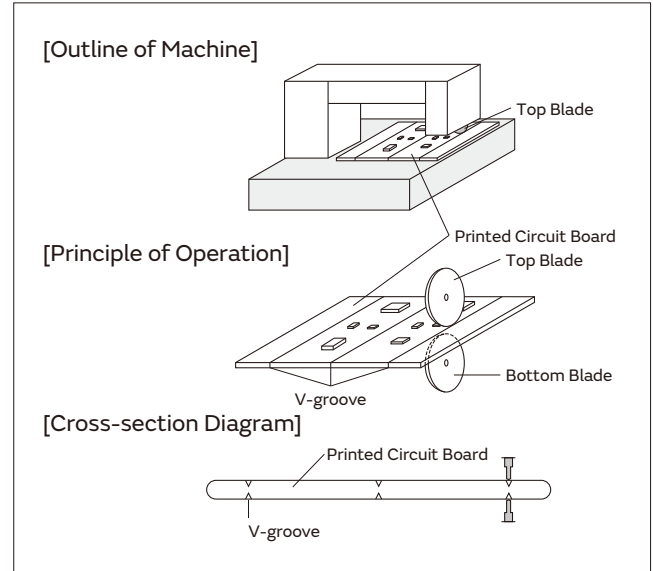

Disc Separator

Recommended	Not Recommended		
	Top-bottom Misalignment	Left-right Misalignment	Front-rear Misalignment
<p>Top Blade</p> <p>Bottom Blade</p>	<p>Top Blade</p> <p>Bottom Blade</p>	<p>Top Blade</p> <p>Bottom Blade</p>	<p>Top Blade</p> <p>Bottom Blade</p>

V-groove Design

Example of Recommended V-groove Design	Not Recommended			
	Left-right Misalignment	Low-Angle	Depth too Shallow	Depth too Deep

(3) Example of Router Type Separator

The router type separator performs cutting by a router rotating at a high speed. Since the board does not bend in the cutting process, stress on the board can be suppressed during board separation.

When attaching or removing boards to/from the router type separator, carefully handle the boards to prevent bending.

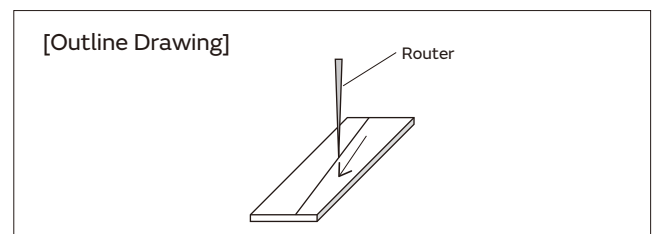

Continued on the following page. ↗

GRM
 GR3
 GRJ
 GR4
 GJM
 GQM
 GA2
 GA3 GB
 GA3 GD
 GA3 GF
 LLL
 LLA
 LLM
 LLR
 NFM
 GJ4
 ZRA
 ZRB
 KRM
 KR3
 GMA
 GMD
 ⚠Caution

⚠Caution

Continued from the preceding page. ↘

8. Assembly

1. Handling

If a board mounted with capacitors is held with one hand, the board may bend. Firmly hold the edges of the board with both hands when handling.

If a board mounted with capacitors is dropped, cracks may occur in the capacitors.

Do not use dropped boards, as there is a possibility that the quality of the capacitors may be impaired.

2. Attachment of Other Components

2-1. Mounting of Other Components

Pay attention to the following items, when mounting other components on the back side of the board after capacitors have been mounted on the opposite side.

When the bottom dead point of the suction nozzle is set too low, board deflection stress may be applied to the capacitors on the back side (bottom side), and cracks may occur in the capacitors.

- After the board is straightened, set the bottom dead point of the nozzle on the upper surface of the board.
- Periodically check and adjust the bottom dead point.

2-2. Inserting Components with Leads into Boards

When inserting components (transformers, IC, etc.) into boards, bending the board may cause cracks in the capacitors or cracks in the solder.

Pay attention to the following.

- Increase the size of the holes to insert the leads, to reduce the stress on the board during insertion.
- Fix the board with support pins or a dedicated jig before insertion.
- Support below the board so that the board does not bend. When using support pins on the board, periodically confirm that there is no difference in the height of each support pin.

2-3. Attaching/Removing Sockets and/or Connectors

Insertion and removal of sockets and connectors, etc., might cause the board to bend. Please insure that the board does not warp during insertion and removal of sockets and connectors, etc., or the bending may damage mounted components on the board.

2-4. Tightening Screws

The board may be bent, when tightening screws, etc. during the attachment of the board to a shield or chassis.

Pay attention to the following items before performing the work.

- Plan the work to prevent the board from bending.
- Use a torque screwdriver, to prevent over-tightening of the screws.
- The board may bend after mounting by reflow soldering, etc. Please note, as stress may be applied to the chips by forcibly flattening the board when tightening the screws.

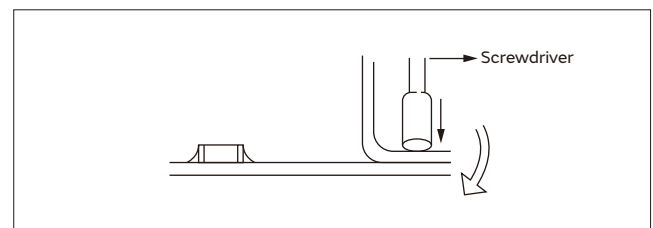
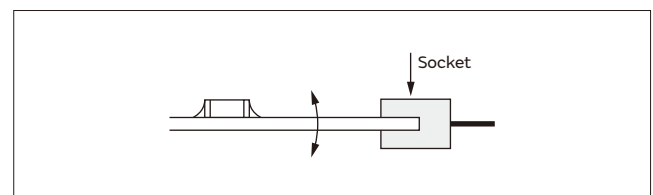
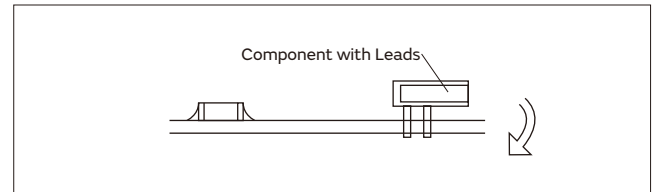
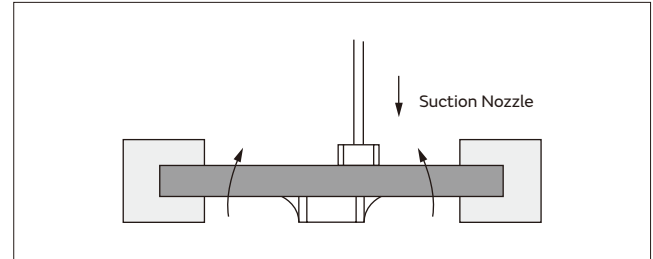

GRM

GR3

GRJ

GR4

GJM

GQM

GA2

GA3

GB

GA3

GD

GA3

GF

LLL

LLA

LLM

LLR

NFM

GJ4

ZRA

ZRB

KRM

KR3

GMA

GMD

△Caution

Continued on the following page. ↗

⚠Caution

Continued from the preceding page. ↘

<Applicable to GMA or GMD Series>

9. Die Bonding/Wire Bonding

1. Die Bonding of Capacitors

1-1. Use the following materials for the Brazing alloys:

Au-Sn (80/20) 300 to 320 °C in N₂ atmosphere

1-2. Mounting

- (1) Control the temperature of the substrate so it matches the temperature of the brazing alloy.
- (2) Place the brazing alloy on the substrate and place the capacitor on the alloy. Hold the capacitor and gently apply the load. Be sure to complete the operation within 1 minute.

2. Wire Bonding

2-1. Wire

Gold wire: 25 micro m (0.001 inch) diameter

2-2. Bonding

- (1) Thermo compression, ultrasonic ball bonding.
- (2) Required stage temperature: 150 to 200 °C
- (3) Required wedge or capillary weight: 0.2N to 0.5N
- (4) Bond the capacitor and base substrate or other devices with gold wire.

Other

1. Under Operation of Equipment

- 1-1. Do not touch a capacitor directly with bare hands during operation in order to avoid the danger of an electric shock.
- 1-2. Do not allow the terminals of a capacitor to come in contact with any conductive objects (short-circuit). Do not expose a capacitor to a conductive liquid, including any acid or alkali solutions.
- 1-3. Confirm the environment in which the equipment will operate is under the specified conditions. Do not use the equipment under the following environments.
 - (1) Being splattered with water or oil.
 - (2) Being exposed to direct sunlight.
 - (3) Being exposed to ozone, ultraviolet rays, or radiation.
 - (4) Being exposed to toxic gas (e.g., hydrogen sulfide, sulfur dioxide, chlorine, ammonia gas, etc.)
 - (5) Any vibrations or mechanical shocks exceeding the specified limits.
 - (6) Moisture condensing environments. (GXM Series: Terrible moisture condensing environments).
- 1-4. Use damp proof countermeasures if using under any conditions that can cause condensation. (GXM Series: Use damp proof countermeasures if using under any conditions that can cause terrible condensation).

Continued on the following page. ↗

GRM

GR3

GRJ

GR4

GJM

GQM

GA2

GA3

GA3

GA3

GA3

LLL

LLA

LLM

LLR

NFM

GJ4

ZRA

ZRB

KRM

KR3

GMA

GMD

⚠Caution

⚠Caution

Continued from the preceding page. ↘

2. Other

2-1. In an Emergency

- (1) If the equipment should generate smoke, fire, or smell, immediately turn off or unplug the equipment.
If the equipment is not turned off or unplugged, the hazards may be worsened by supplying continuous power.
- (2) In this type of situation, do not allow face and hands to come in contact with the capacitor or burns may be caused by the capacitor's high temperature.

2-2. Disposal of Waste

When capacitors are disposed of, they must be burned or buried by an industrial waste vendor with the appropriate licenses.

2-3. Circuit Design

(1) Addition of Fail Safe Function

Capacitors that are cracked by dropping or bending of the board may cause deterioration of the insulation resistance, and result in a short. If the circuit being used may cause an electrical shock, smoke or fire when a capacitor is shorted, be sure to install fail-safe functions, such as a fuse, to prevent secondary accidents.

- (2) Capacitors used to prevent electromagnetic interference in the primary AC side circuit, or as a connection/insulation, must be a safety standard certified product, or satisfy the contents stipulated in the Electrical Appliance and Material Safety Law. Install a fuse for each line in case of a short.

- (3) The GRM, GR3, GRJ, GXM, GJM, GQM, LLL, LLA, LLM, LLR, NFM, GJ4, ZRA, ZRB, KRM, KR3, GMA and GMD series are not safety standard certified products.

2-4. Test Condition for AC Withstanding Voltage

(1) Test Equipment

Test equipment for AC withstanding voltage should be made with equipment capable of creating a wave similar to a 50/60Hz sine wave.

(2) Voltage Applied Method

The capacitor's lead or terminal should be firmly connected to the output of the withstanding voltage test equipment, and then the voltage should be raised from near zero to the test voltage.

If the test voltage is applied directly to the capacitor without raising it from near zero, it should be applied with the zero cross. *At the end of the test time, the test voltage should be reduced to near zero, and then capacitor's lead or terminals should be taken off the output of the withstanding voltage test equipment.

If the test voltage applied directly to the capacitor without raising it from near zero, surge voltage may occur and cause a defect.

*ZERO CROSS is the point where voltage sine wave passes 0V. - See the figure at right -

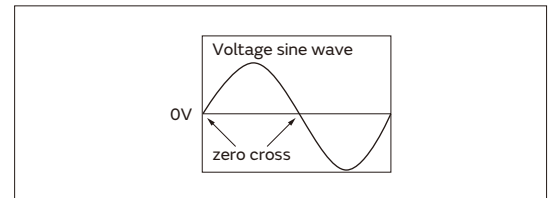

2-5. Remarks

Failure to follow the cautions may result, worst case, in a short circuit and smoking when the product is used.

The above notices are for standard applications and conditions. Contact us when the products are used in special mounting conditions.

Select optimum conditions for operation as they determine the reliability of the product after assembly.

The data herein are given in typical values, not guaranteed ratings.

GRM

GR3

GRJ

GR4

GJM

GQM

GA2

GA3 GB

GA3 GD

GA3 GF

LLL

LLA

LLM

LLR

NFM

GJ4

ZRA

ZRB

KRM

KR3

GMA

GMD

⚠Caution

Notice

Rating

1. Operating Temperature

1. The operating temperature limit depends on the capacitor.
 - 1-1. Do not apply temperatures exceeding the maximum operating temperature.
It is necessary to select a capacitor with a suitable rated temperature that will cover the operating temperature range.
It is also necessary to consider the temperature distribution in equipment and the seasonal temperature variable factor.
 - 1-2. Consider the self-heating factor of the capacitor.
The surface temperature of the capacitor shall not exceed the maximum operating temperature including self-heating.

2. Atmosphere Surroundings (gaseous and liquid)

1. Restriction on the operating environment of capacitors.
 - 1-1. Capacitors, when used in the above, unsuitable, operating environments may deteriorate due to the corrosion of the terminations and the penetration of moisture into the capacitor.
 - 1-2. The same phenomenon as the above may occur when the electrodes or terminals of the capacitor are subject to moisture condensation.
 - 1-3. The deterioration of characteristics and insulation resistance due to the oxidization or corrosion of terminal electrodes may result in breakdown when the capacitor is exposed to corrosive or volatile gases or solvents for long periods of time.

Soldering and Mounting

1. PCB Design

1. Notice for Pattern Forms
 - 1-1. Unlike leaded components, chip components are susceptible to flexing stresses since they are mounted directly on the substrate.
They are also more sensitive to mechanical and thermal stresses than leaded components.
Excess solder fillet height can multiply these stresses and cause chip cracking. When designing substrates, take land patterns and dimensions into consideration to eliminate the possibility of excess solder fillet height.
 - 1-2. There is a possibility of chip cracking caused by PCB expansion/contraction with heat, because stress on a chip is different depending on PCB material and structure. When the thermal expansion coefficient greatly differs between the board used for mounting and the chip, it will cause cracking of the chip due to the thermal expansion and contraction.
When capacitors are mounted on a fluorine resin printed circuit board or on a single-layered glass epoxy board, it may also cause cracking of the chip for the same reason.

3. Piezo-electric Phenomenon

1. When using high dielectric constant type capacitors in AC or pulse circuits, the capacitor itself vibrates at specific frequencies and noise may be generated.
Moreover, when the mechanical vibration or shock is added to the capacitor, noise may occur.

- 1-3. If you are replacing by smaller capacitors, you should not only consider the Land size change but also consider changing the Wiring Width, Wiring direction, and copper foil thickness because the risk of chip cracking is increased with just a Land size change.

<Applicable to NFM Series>

- 1-4. Because noise is suppressed by shunting unwanted high-frequency components to the ground, when designing a land for the NFM series, design the ground pattern to be as large as possible in order to better bring out this characteristic.
As shown in the figure below, noise countermeasures can be made more effective by using a via to connect the ground pattern on the chip mounting surface to a larger ground pattern on the inner layer.

Continued on the following page. ↗

Notice

Continued from the preceding page. ↘

Pattern Forms

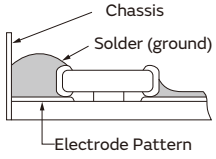
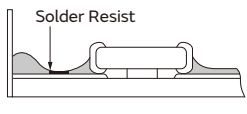
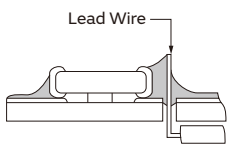
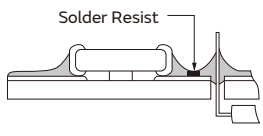
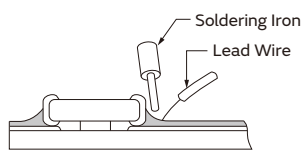
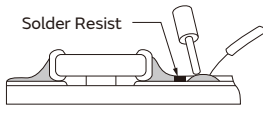
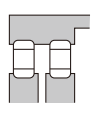
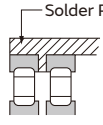
	Prohibited	Correct
Placing Close to Chassis	 <p>Chassis Solder (ground) Electrode Pattern</p> <p style="text-align: right;">in section</p>	 <p>Solder Resist</p> <p style="text-align: right;">in section</p>
Placing of Chip Components and Leaded Components	 <p>Lead Wire</p> <p style="text-align: right;">in section</p>	 <p>Solder Resist</p> <p style="text-align: right;">in section</p>
Placing of Leaded Components after Chip Component	 <p>Soldering Iron Lead Wire</p> <p style="text-align: right;">in section</p>	 <p>Solder Resist</p> <p style="text-align: right;">in section</p>
Lateral Mounting		 <p>Solder Resist</p>

2. Land Dimensions

2-1. Please refer to the land dimensions in table 1 for flow soldering, table 2 for reflow soldering, table 3 for reflow soldering for ZRB Series, table 4 for reflow soldering for LLA Series, table 5 for reflow soldering for LLM Series, table 6 and 7 for reflow soldering for ZRA Series.

Please confirm the suitable land dimension by evaluating of the actual SET / PCB.

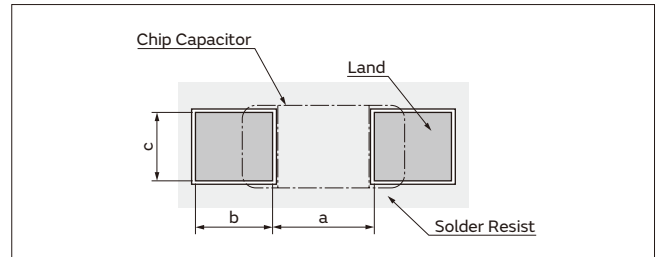

Table 1 Flow Soldering Method

Series	Chip Dimension Code (L/W)	Chip (L×W)	a	b	c
GQM/GR3/GRJ/GRM	18	1.6×0.8	0.6 to 1.0	0.8 to 0.9	0.6 to 0.8
GQM/GR3/GRJ/GRM	21	2.0×1.25	1.0 to 1.2	0.9 to 1.0	0.8 to 1.1
GR3/GRJ/GRM	31	3.2×1.6	2.2 to 2.6	1.0 to 1.1	1.0 to 1.4
LLL	21	1.25×2.0	0.4 to 0.7	0.5 to 0.7	1.4 to 1.8
LLL	31	1.6×3.2	0.6 to 1.0	0.8 to 0.9	2.6 to 2.8

(in mm)

Continued on the following page. ↗

Notice

Continued from the preceding page. ↘

Table 2 Reflow Soldering Method

Series	Chip Dimension Code (L/W)	Chip (L×W)	a	b	c
GRM	01	0.25×0.125	0.10 to 0.11	0.07 to 0.12	0.125 to 0.145
GRM/GJM	02	0.4×0.2	0.16 to 0.2	0.12 to 0.18	0.2 to 0.23
GRM	MD	0.5×0.25	0.17 to 0.23	0.22 to 0.28	0.25 to 0.30
GRM/GJM	03	0.6×0.3 (±0.03)	0.2 to 0.25	0.2 to 0.3	0.25 to 0.35
		0.6×0.3 (±0.05)	0.2 to 0.25	0.25 to 0.35	0.3 to 0.4
		0.6×0.3 (±0.09)	0.23 to 0.3	0.25 to 0.35	0.3 to 0.4
GRM/GXM/GJM	15	1.0×0.5 (within ±0.10)	0.3 to 0.5	0.35 to 0.45	0.4 to 0.6
		1.0×0.5 (±0.15/±0.20)	0.4 to 0.6	0.4 to 0.5	0.5 to 0.7
GRM/GXM/GJM/GQM	18	1.6×0.8 (within ±0.10)	0.6 to 0.8	0.6 to 0.7	0.6 to 0.8
		1.6×0.8 (±0.15/±0.20)	0.7 to 0.9	0.7 to 0.8	0.8 to 1.0
GRM	JN	1.8×1.0	0.8 to 0.9	0.6 to 0.8	0.9 to 1.1
GQM	21	2.0×1.25	1.0 to 1.2	0.6 to 0.7	0.8 to 1.1
GRM/GXM/GRJ/GJ4	21	2.0×1.25 (within ±0.10)	1.2	0.6	1.25
		2.0×1.25 (±0.15)	1.2	0.6 to 0.8	1.2 to 1.4
		2.0×1.25 (±0.20)	1.0 to 1.4	0.6 to 0.8	1.2 to 1.4
GQM	22	2.8×2.8	2.2 to 2.5	0.8 to 1.0	1.9 to 2.3
GRM/GXM/GRJ/GJ4	31	3.2×1.6 (within ±0.20)	1.8 to 2.0	0.9 to 1.2	1.5 to 1.7
		3.2×1.6 (±0.30)	1.9 to 2.1	1.0 to 1.3	1.7 to 1.9
GRM/GXM/GRJ	32	3.2×2.5	2.0 to 2.4	1.0 to 1.2	1.8 to 2.3
GA2/GA3/GR4	42	4.5×2.0	2.8 to 3.4	1.2 to 1.4	1.4 to 1.8
GR3/GRJ/GRM/GA2/GA3/GR4	43	4.5×3.2	3.0 to 3.5	1.2 to 1.4	2.3 to 3.0
GA2/GA3	52	5.7×2.8	4.0 to 4.6	1.4 to 1.6	2.1 to 2.6
GR3/GRJ/GRM/GA2/GA3/GR4	55	5.7×5.0	4.0 to 4.6	1.4 to 1.6	3.5 to 4.8
LLL	15	0.5×1.0	0.15 to 0.2	0.2 to 0.25	0.7 to 1.0
LLL	1U	0.6×1.0	0.20 to 0.25	0.25 to 0.35	0.7 to 1.0
LLL/LLR	18	0.8×1.6	0.2 to 0.3	0.3 to 0.4	1.4 to 1.6
LLL	21	1.25×2.0	0.4 to 0.5	0.4 to 0.5	1.4 to 1.8
LLL	31	1.6×3.2	0.6 to 0.8	0.6 to 0.7	2.6 to 2.8

(in mm)

<Applicable to Part Number KR3/KRM>

Series	Chip Dimension Code (L/W)	Chip (L×W)	a	b	c
KRM	21	2.0×1.25	1.0 to 1.2	0.6 to 0.7	0.8 to 1.1
KRM	31	3.2×1.6	2.2 to 2.4	0.8 to 0.9	1.0 to 1.4
KR3/KRM	55	5.7×5.0	2.6	2.7	5.6

(in mm)

Table 3 ZRB Series Reflow Soldering Method

Series	Chip Dimension Code (L/W)	Chip (L×W)	a	b	c
ZRB	15	1.0×0.5	0.4 to 0.6	0.4 to 0.5	0.5 to 0.7
ZRB	18*	1.6×0.8	0.7 to 0.9	0.7 to 0.8	0.8 to 1.0

*If distance between parts is too short, there is risk to cause electrical short. Please confirm the mounting pitch (distance between centers of parts) has 1.275mm or more. (ZRB18 only)

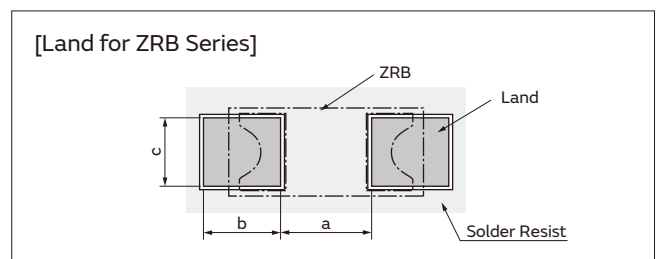

Table 4 LLA Series Reflow Soldering Method

Series	Chip Dimension Code (L/W)	Chip (L×W)	a	b	c	p
LLA	18	1.6×0.8	0.3 to 0.4	0.25 to 0.35	0.15 to 0.25	0.4
LLA	21	2.0×1.25	0.5 to 0.7	0.35 to 0.6	0.2 to 0.3	0.5

(in mm)

Continued on the following page. ↗

Notice

Continued from the preceding page. ↘

Table 5 LLM Series Reflow Soldering Method

Series	Chip Dimension Code (L/W)	Chip (L×W)	a	b, b'	c, c'	d	e	f	p
LLM	21	2.0×1.25	0.6 to 0.8	(0.3 to 0.5)	0.3	2.0 to 2.6	1.3 to 1.8	1.4 to 1.6	0.5

$b=(c-e)/2, b'=(d-f)/2$ (in mm)

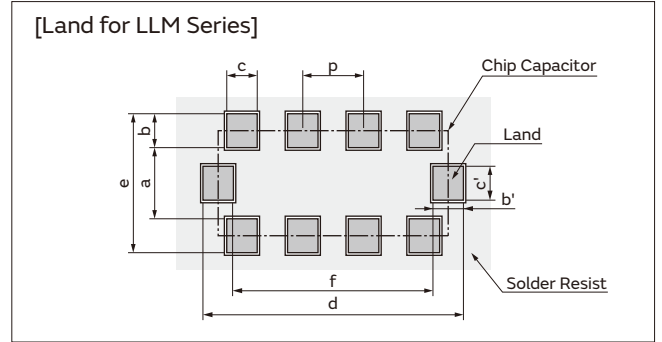
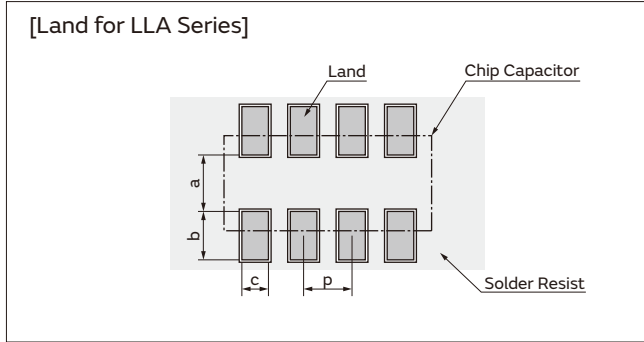

<Applicable to beyond Rated Voltage of 200VDC>

2-2. Dimensions of Slit (Example)

Preparing the slit helps flux cleaning and resin coating on the back of the capacitor.

However, the length of the slit design should be as short as possible to prevent mechanical damage in the capacitor.

A longer slit design might receive more severe mechanical stress from the PCB.

Recommended slit design is shown in the Table.

L×W	d	e
1.6×0.8	-	-
2.0×1.25	-	-
3.2×1.6	1.0 to 2.0	3.2 to 3.7
3.2×2.5	1.0 to 2.0	4.1 to 4.6
4.5×2.0	1.0 to 2.8	3.6 to 4.1
4.5×3.2	1.0 to 2.8	4.8 to 5.3
5.7×2.8	1.0 to 4.0	4.4 to 4.9
5.7×5.0	1.0 to 4.0	6.6 to 7.1

(in mm)

<Applicable to ZRA Series>

Please refer to the land dimensions in Table 6 and the solder amount in Table 7 for ZRA series.

(1) Recommended Land Dimensions

Table 6 Land Dimensions

Series	Chip Dimension Code (L/W)	Chip (L×W)	a	b	c
ZRA	21	2.4×1.65	0.8±0.05	1.0±0.05	1.4±0.05

(in mm)

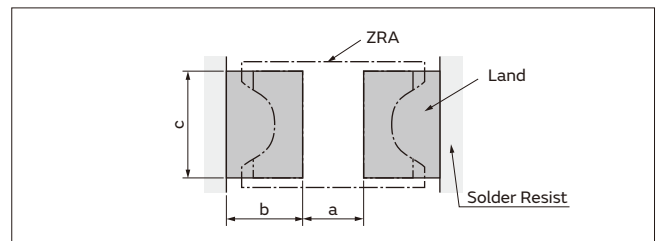

(2) Recommended Solder Amount

Table 7 Solder Amount

Series	Chip Dimension Code (L/W)	Thickness	a'	b'	c'
ZRA	21	0.1	0.8±0.05	1.0±0.05	0.7±0.05

(in mm)

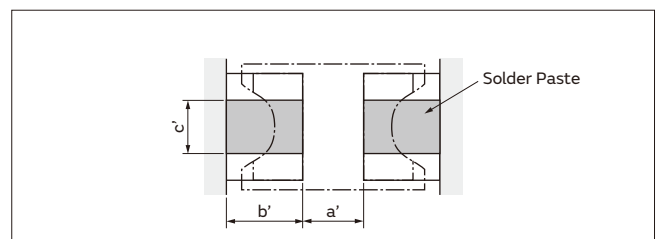

Continued on the following page. ↗

Notice

Continued from the preceding page. ↘

<Applicable to NFM Series>

Land Pattern + Solder Resist Land Pattern Solder Resist (in mm)

Series	Land Dimensions
NFM15CC NFM15PC NFMJMPC NFM18CC NFM18PC NFM18PS NFM21CC NFM21PC NFM21PS	<p>● Reflow Soldering</p> <p>NFM15CC/NFM15PC</p> <p>NFMJMPC</p> <p>NFM18CC/NFM18PC</p> <p>NFM18PS</p> <p>NFM21CC/NFM21PC</p> <p>NFM21PS</p> <p>In case of changing the land dimensions marked by *, a solder bridge between terminations of the chip could occur. In this case, please contact us before change.</p>

NFM3DCC NFM3DPC NFM31PC NFM31KC NFM41CC NFM41PC	<p>● Reflow Soldering Chip mounting side</p> <p>NFM3DCC/NFM3DPC/NFM31PC/NFM41CC/NFM41PC</p> <p>Small diameter thru hole ø0.4</p> <table border="1"> <thead> <tr> <th rowspan="2">Part Number</th> <th colspan="7">Size (mm)</th> </tr> <tr> <th>a</th> <th>b</th> <th>c</th> <th>d</th> <th>e</th> <th>f</th> <th>g</th> </tr> </thead> <tbody> <tr> <td>NFM3DCC NFM3DPC</td> <td>1.0</td> <td>1.4</td> <td>2.5</td> <td>4.4</td> <td>1.0</td> <td>2.0</td> <td>2.4</td> </tr> <tr> <td>NFM31PC</td> <td>1.0</td> <td>1.4</td> <td>2.5</td> <td>4.4</td> <td>1.2</td> <td>2.6</td> <td>3.0</td> </tr> <tr> <td>NFM41CC NFM41PC</td> <td>1.5</td> <td>2.0</td> <td>3.5</td> <td>6.0</td> <td>1.2</td> <td>2.6</td> <td>3.0</td> </tr> </tbody> </table>	Part Number	Size (mm)							a	b	c	d	e	f	g	NFM3DCC NFM3DPC	1.0	1.4	2.5	4.4	1.0	2.0	2.4	NFM31PC	1.0	1.4	2.5	4.4	1.2	2.6	3.0	NFM41CC NFM41PC	1.5	2.0	3.5	6.0	1.2	2.6	3.0	<p>● Flow Soldering Chip mounting side</p> <p>NFM31KC*1</p> <p>Small diameter thru hole ø0.4</p> <p>*1 For large current design, width of signal land pattern should be wider not less than 1mm per 1A (1mm/A). For example, in case of 10A, signal land pattern width should be 10mm or more. (1mm/A*10A=10mm)</p>
	Part Number		Size (mm)																																						
a		b	c	d	e	f	g																																		
NFM3DCC NFM3DPC	1.0	1.4	2.5	4.4	1.0	2.0	2.4																																		
NFM31PC	1.0	1.4	2.5	4.4	1.2	2.6	3.0																																		
NFM41CC NFM41PC	1.5	2.0	3.5	6.0	1.2	2.6	3.0																																		
	<p>Small diameter thru hole ø0.4</p> <p>*1 For large current design, width of signal land pattern should be wider not less than 1mm per 1A (1mm/A). For example, in case of 10A, signal land pattern width should be 10mm or more. (1mm/A*10A=10mm)</p>	<p>Small diameter thru hole ø0.4</p> <p>*1 For large current design, width of signal land pattern should be wider not less than 1mm per 1A (1mm/A). For example, in case of 10A, signal land pattern width should be 10mm or more. (1mm/A*10A=10mm)</p>																																							

Continued on the following page. ↗

GRM
 GR3
 GRJ
 GR4
 GJM
 GQM
 GA2
 GA3 GB
 GA3 GD
 GA3 GF
 LLL
 LLA
 LLM
 LLR
 NFM
 GJ4
 ZRA
 ZRB
 KRM
 KR3
 GMA
 GMD
 Notice
 280

Notice

Continued from the preceding page. ↘

3. Board Design

When designing the board, keep in mind that the amount of strain which occurs will increase depending on the size and material of the board.

[Relationship with amount of strain to the board thickness, length, width, etc.]

$$\epsilon = \frac{3PL}{2Ewh^2} \quad \text{Relationship between load and strain}$$

ϵ : Strain on center of board (μst)
 L : Distance between supporting points (mm)
 w : Board width (mm)
 h : Board thickness (mm)
 E : Elastic modulus of board ($\text{N}/\text{m}^2=\text{Pa}$)
 Y : Deflection (mm)
 P : Load (N)

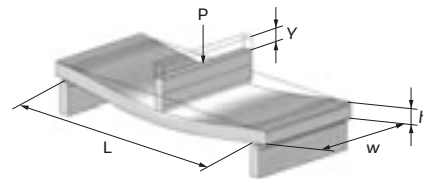

When the load is constant, the following relationship can be established.

- As the distance between the supporting points (L) increases, the amount of strain also increases.
 →Reduce the distance between the supporting points.
 - As the elastic modulus (E) decreases, the amount of strain increases.
 →Increase the elastic modulus.
 - As the board width (w) decreases, the amount of strain increases.
 →Increase the width of the board.
 - As the board thickness (h) decreases, the amount of strain increases.
 →Increase the thickness of the board.
- Since the board thickness is squared, the effect on the amount of strain becomes even greater.

2. Item to be confirmed for Flow soldering

If you want to temporarily attach the capacitor to the board using an adhesive agent before soldering the capacitor, first be sure that the conditions are appropriate for affixing the capacitor. If the dimensions of the land, the type of adhesive, the amount of coating, the contact surface area, the curing temperature, or other conditions are inappropriate, the characteristics of the capacitor may deteriorate.

1. Selection of Adhesive

1-1. Depending on the type of adhesive, there may be a decrease in insulation resistance. In addition, there is a chance that the capacitor might crack from contractile stress due to the difference in the contraction rate of the capacitor and the adhesive.

1-2. If there is not enough adhesive, the contact surface area is too small, or the curing temperature or curing time are inadequate, the adhesive strength will be insufficient and the capacitor may loosen or become disconnected during transportation or soldering. If there is too much adhesive, for example if it overflows onto the land, the result could be soldering defects, loss of electrical connection, insufficient curing, or slippage after the capacitor is mounted.

Furthermore, if the curing temperature is too high or the curing time is too long, not only will the adhesive

strength be reduced, but solderability may also suffer due to the effects of oxidation on the terminations (outer electrodes) of the capacitor and the land surface on the board.

(1) Selection of Adhesive

Epoxy resins are a typical class of adhesive.

To select the proper adhesive, consider the following points.

- 1) There must be enough adhesive strength to prevent the component from loosening or slipping during the mounting process.
- 2) The adhesive strength must not decrease when exposed to moisture during soldering.
- 3) The adhesive must have good coatability and shape retention properties.
- 4) The adhesive must have a long pot life.
- 5) The curing time must be short.
- 6) The adhesive must not be corrosive to the exterior of the capacitor or the board.
- 7) The adhesive must have good insulation properties.
- 8) The adhesive must not emit toxic gases or otherwise be harmful to health.
- 9) The adhesive must be free of halogenated compounds.

Continued on the following page. ↗

Notice

Continued from the preceding page. ↘

(2) Use the following illustration as a guide to the amount of adhesive to apply.

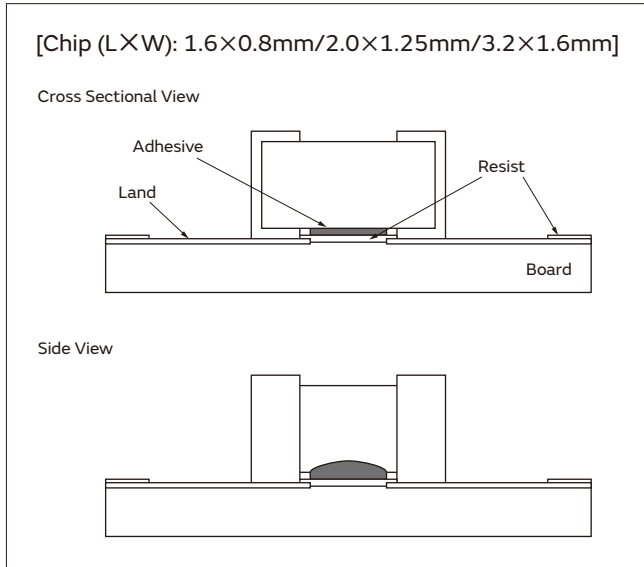

<Applicable to NFM Series>

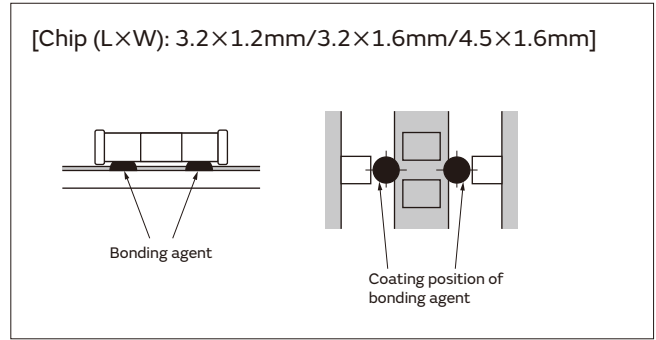

2. Flux

- 2-1. An excessive amount of flux generates a large quantity of flux gas, which can cause a deterioration of solderability, so apply flux thinly and evenly throughout. (A foaming system is generally used for flow soldering.)
- 2-2. Flux containing too high a percentage of halide may cause corrosion of the terminations unless there is sufficient cleaning. Use flux with a halide content of 0.1% max.
- 2-3. Strong acidic flux can corrode the capacitor and degrade its performance.
Please check the quality of capacitor after mounting.

3. Leaching of the terminations

- Set temperature and time to ensure that leaching of the terminations does not exceed 25% of the chip end area as a single chip (full length of the edge A-B-C-D shown at right) and 25% of the length A-B shown as mounted on substrate.

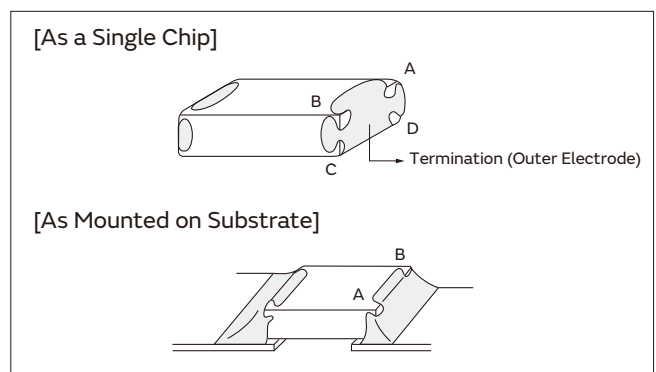

3. Reflow Soldering

The flux in the solder paste contains halogen-based substances and organic acids as activators. Strong acidic flux can corrode the capacitor and degrade its performance.
Please check the quality after mounting, please use.

Continued on the following page. ↗

GRM
GR3
GRJ
GR4
GJM
GQM
GA2
GA3 GB
GA3 GD
GA3 GF
LLL
LLA
LLM
LLR
NFM
GJ4
ZRA
ZRB
KPM
KR3
GMA
GMD
Notice

Notice

Continued from the preceding page. ↘

4. Washing

1. Please evaluate the capacitor using actual cleaning equipment and conditions to confirm the quality, and select the solvent for cleaning.

5. Coating

1. A crack may be caused in the capacitor due to the stress of the thermal contraction of the resin during curing process.
The stress is affected by the amount of resin and curing contraction.
Select a resin with low curing contraction.
The difference in the thermal expansion coefficient between a coating resin or a molding resin and the capacitor may cause the destruction and deterioration of the capacitor such as a crack or peeling, and lead to the deterioration of insulation resistance or dielectric breakdown.
Select a resin for which the thermal expansion coefficient is as close to that of the capacitor as possible.
A silicone resin can be used as an under-coating to buffer against the stress.

2. Unsuitable cleaning may leave residual flux or other foreign substances, causing deterioration of electrical characteristics and the reliability and water repellency* of the capacitors.

*GXM only

2. Select a resin that is less hygroscopic.
Using hygroscopic resins under high humidity conditions may cause the deterioration of the insulation resistance of a capacitor.
An epoxy resin can be used as a less hygroscopic resin.
3. The halogen system substance and organic acid are included in coating material, and a chip corrodes by the kind of Coating material.
Do not use strong acid type.

<Applicable to ZRA/ZRB Series>

4. Loss suppress acoustic noise may be caused in ZRA/ZRB series due to the resin during curing process. Please contact our sales representative or product engineers on the apply to resin during curing process.

Other

1. Transportation

1. The performance of a capacitor may be affected by the conditions during transportation.
 - 1-1. The capacitors shall be protected against excessive temperature, humidity, and mechanical force during transportation.
 - Mechanical condition
Transportation shall be done in such a way that the boxes are not deformed and forces are not directly passed on to the inner packaging.
 - 1-2. Do not apply excessive vibration, shock, or pressure to the capacitor.
 - (1) When excessive mechanical shock or pressure is applied to a capacitor, chipping or cracking may occur in the ceramic body of the capacitor.
 - (2) When the sharp edge of an air driver, a soldering iron, tweezers, a chassis, etc. impacts strongly on the surface of the capacitor, the capacitor may crack and short-circuit.
 - 1-3. Do not use a capacitor to which excessive shock was applied by dropping, etc.
A capacitor dropped accidentally during processing may be damaged.

2. Characteristics Evaluation in the Actual System

1. Evaluate the capacitor in the actual system, to confirm that there is no problem with the performance and specification values in a finished product before using.
2. Since a voltage dependency and temperature dependency exists in the capacitance of high dielectric type ceramic capacitors, the capacitance may change depending on the operating conditions in the actual system. Therefore, be sure to evaluate the various characteristics, such as the leakage current and noise absorptivity, which will affect the capacitance value of the capacitor.
3. In addition, voltages exceeding the predetermined surge may be applied to the capacitor by the inductance in the actual system. Evaluate the surge resistance in the actual system as required.

<Applicable to NFM Series>

4. The effects of noise suppression can vary depending on the usage conditions, including differences in the circuit or IC to be used, the type of noise, the shape of the pattern to be mounted, and the mounting location. Be sure to verify the effect on the actual device in advance.

GRM

GR3

GRJ

GR4

GJM

GQM

GA2

GA3

GB

GA3

GD

GA3

GF

LLL

LLA

LLM

LLR

NFM

GJ4

ZRA

ZRB

KPM

KR3

GMA

GMD

Notice

283

Design Support Tool "SimSurfing"

<https://ds.murata.co.jp/simsurfing/index.html>

This is the latest tool to get the electrical characteristics for Capacitors, Inductors, and EMI Suppression Filters, and to simulate Thermistors' behavior !

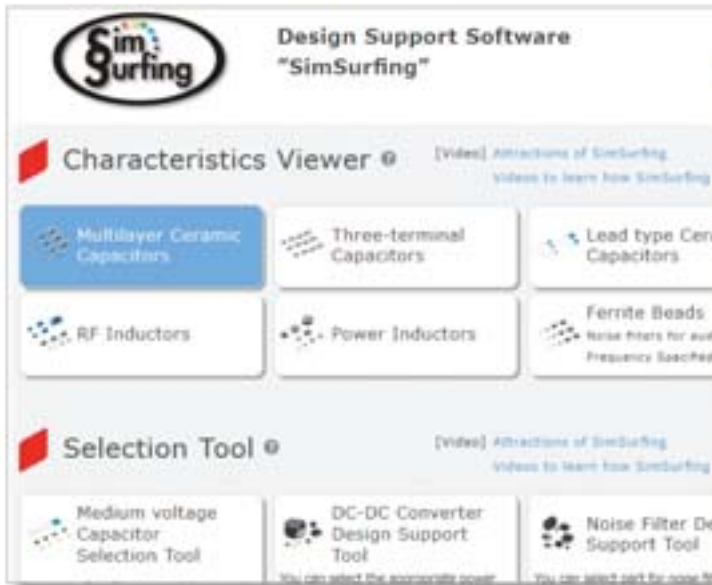

■ Characteristics viewer

You can easily search and download the following data for Multilayer Ceramic Capacitors, Polymer Capacitors, EMI Suppression Filters (Three-terminal Capacitors, Ferrite Beads) and Power/RF Inductors.

■ Components performance simulator

You can search by the simulation on simple circuits for Thermistors.

■ Selection tool

You can select Medium voltage Capacitors and Power Inductors according to conditions of use.

* Medium voltage: Rated Voltage 250V and over

■ Search tool

You can search the Murata timing device (CERALOCK® and crystal units) that is most suitable for your IC and access information about the recommended circuit constant setting.

■ Usage example of "Multilayer Ceramic Capacitors"

1 Select the products

- (1) By performance/type
- (2) By part number

2 Show graph

Click each button on each tab of [Basic], [S-parameter] and [Detailed].

3 Data download

- Click each purple button in this area.
- Click "CSV output" button.

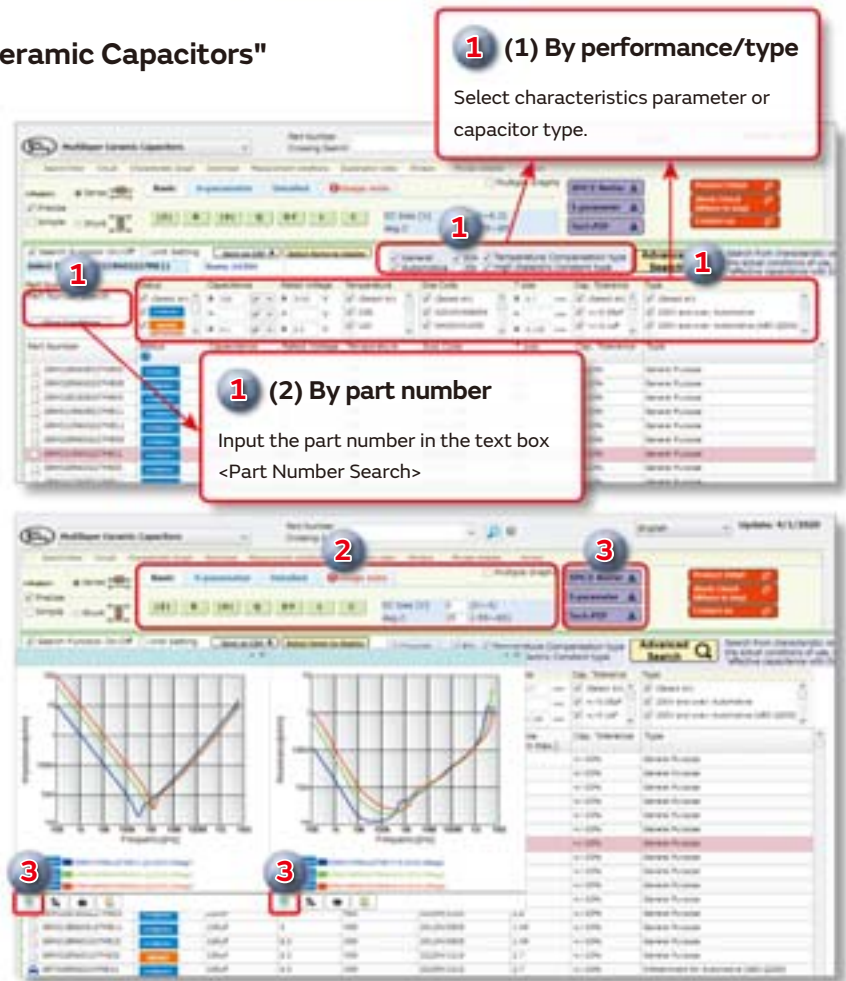

* Images are as of May 2020. Be assured that this software will be updated frequently.

<https://ds.murata.co.jp/simsurfing/index.html>

Web page Introduction



Search by Part Number

<https://www.murata.com/search/productsearch?cate=cgsubCeramicCapacitors>

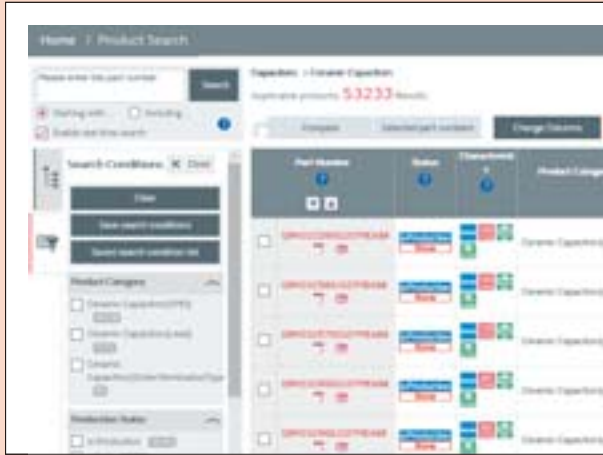

You can search for capacitors by specifying the alphanumeric characters in the part number. The packing codes shown contain the substitute character "#". If you enter the official packing code, part numbers that contain that packing code will be matched.



Search by Specifications

<https://www.murata.com/search/productsearch?cate=luCeramicCapacitorsSMD#spec>



You can search for SMD, lead type, or screw termination type capacitors by indicating specifications such as application, capacitance, rated voltage, or temperature characteristics.

You can narrow your search by entering values of ranges, and by specifying product characteristics.

The items for narrowing searches are linked, so specifying one condition causes selectable options for the other items to allow input only of conditions that match the relevant part numbers.



Search in the Lineups

<https://www.murata.com/products/capacitor/mlcc/lineup>

You can search for capacitors by specifying the series lineup.

You can also confirm items such as characteristics and applications on each series page.



Capacitance chart in Series page.



[Search result]

Compares the characteristics of the checked part numbers.

Displays the number of hits for the current search conditions in real time.

Click the ▲ mark for each item to switch between ascending and descending display.

Click a product name to display a details page listing more in-depth information (→ P26).

You can download detailed spec sheets.

For some products it is possible to request a free sample.

Icons enable you to check the status and characteristics of products at a glance.

You narrow the search results to match the selected condition in real time.

You can confirm the current conditions for narrowing the search results.

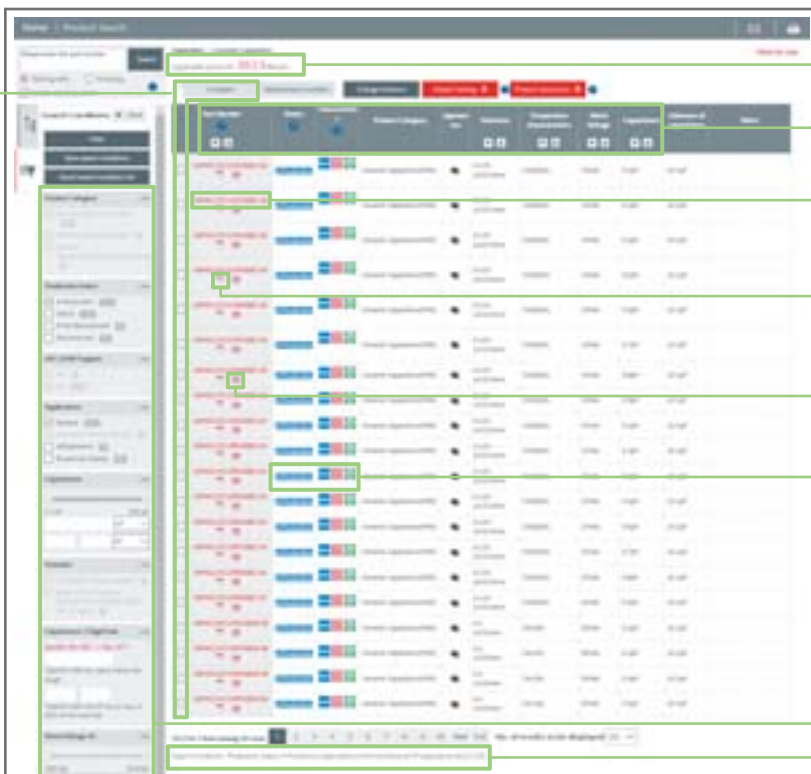

Global Locations

For details please visit www.murata.com



⚠ Note

1 Export Control

For customers outside Japan:

No Murata products should be used or sold, through any channels, for use in the design, development, production, utilization, maintenance or operation of, or otherwise contribution to (1) any weapons (Weapons of Mass Destruction [nuclear, chemical or biological weapons or missiles] or conventional weapons) or (2) goods or systems specially designed or intended for military end-use or utilization by military end-users.

For customers in Japan:

For products which are controlled items subject to the "Foreign Exchange and Foreign Trade Law" of Japan, the export license specified by the law is required for export.

2 Please contact our sales representatives or product engineers before using the products in this catalog for the applications listed below, which require especially high reliability for the prevention of defects which might directly damage a third party's life, body or property, or when one of our products is intended for use in applications other than those specified in this catalog.

- ① Aircraft equipment
- ② Aerospace equipment
- ③ Undersea equipment
- ④ Power plant equipment
- ⑤ Medical equipment
- ⑥ Transportation equipment (vehicles, trains, ships, etc.)
- ⑦ Traffic signal equipment
- ⑧ Disaster prevention / crime prevention equipment
- ⑨ Data-processing equipment
- ⑩ Application of similar complexity and/or reliability requirements to the applications listed above

3 Product specifications in this catalog are as of November 2020. They are subject to change or our products in it may be discontinued without advance notice. Please check with our sales representatives or product engineers before ordering. If there are any questions, please contact our sales representatives or product engineers.

4 Please read rating and ⚠CAUTION (for storage, operating, rating, soldering, mounting and handling) in this catalog to prevent smoking and/or burning, etc.

5 This catalog has only typical specifications. Therefore, please approve our product specifications or transact the approval sheet for product specifications before ordering.

6 Please note that unless otherwise specified, we shall assume no responsibility whatsoever for any conflict or dispute that may occur in connection with the effect of our and/or a third party's intellectual property rights and other related rights in consideration of your use of our products and/or information described or contained in our catalogs. In this connection, no representation shall be made to the effect that any third parties are authorized to use the rights mentioned above under licenses without our consent.

7 No ozone depleting substances (ODS) under the Montreal Protocol are used in our manufacturing process.

Murata Manufacturing Co., Ltd.

www.murata.com

muRata
INNOVATOR IN ELECTRONICS