

NO:TH-21548

承认申请书

APPLICATION FOR APPROVAL

产品符合欧盟 RoHS 环保要求

CUSTOMER: _____
PART NAME: 瓷介电容器
DRAUGHT BY: 胡桂云
CHECKED BY: 秦建国
APPROVERED BY: 刘祥峰
DATE: Sep. 02, 2021

APPROVAL	FIELD

厂商
沂南同皓电子元件有限公司
中国·山东沂南县城花山路 1166 号
电话 (TEL):
传真: (FAX):
邮编: (P. C.):
网址: (WEB SITE)
电邮 (E-Mail):

Mfr.
YINAN DON'S ELECTRONIC COMPONENT CO., LTD
1166, HUASHAN ROAD, YINAN COUNTY, SHANDONG, CHINA

<http://www.sdtfly.com>
yntjjsb@126.com



沂南同皓电子元件有限公司

YINAN DON'S ELECTRONIC COMPONENT., CO., LTD.

瓷介电容器

Ceramic Capacitors

□用途

该产品主要用于彩电、计算机显示器、复印机、节能灯等的电源电路、行输出电路等部分。

□Application

Using for H-out and supply circuits of color TV and monitor、copy machine、inverter lighting.

□外观及结构(Appearance and Structure)

编 码 CODE	品 名 CODE NO.	Dmax (mm)	Tmax (mm)	F (mm)	d (mm)
	CT81-2KV-06b-2B4-221K-1T1	6.5	5.0	5.0	0.55
	CT81-6KV-07b-2B4-151K-1T1	7.5	6.0	5.0	0.55
	CT81-6KV-07b-2B4-221K-2T3	7.5	6.0	7.5	0.55
	CT81-6KV-07b-2B4-101K-2T3	7.5	6.0	7.5	0.55

□标识方法(Marking)

	① 公司代号 Manufacturer's Code
	② 温度特性 Temperature Characteristic
	③ 额定电压 Rated Voltage
	④ 标称容量 Rated Capacitance
	⑤ 容量偏差 Tolerance of Capacitance
	⑥ 生产日期 Production Date

说明：生产日期第一位表示制作年度，标示方法参照年度对照表；第二位表示制作月份，第三位表示具体制作日期，标示方法参照 34 进制对比表；例如：生产日期 8B6 表示：8:18 年 B:11 月，6:6 日

(Production date first said the annual, marking methods according to annual comparison table; second said production month, third said the specific production date marking method of comparison, table 34 hexadecimal; Example: Production date 8B6 show: 8:2018year B: november 6: the 6 day):

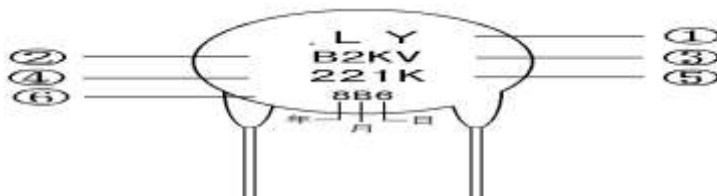

34 进制对比表：

34 进制	0	1	2	3	4	5	6	7	8	9	A	B	C	D	E	F	H
10 进制	0	1	2	3	4	5	6	7	8	9	10	11	12	13	14	15	16
34 进制	J	K	L	M	N	P	Q	R	S	T	V	W	X	Y	Z		
10 进制	17	18	19	20	21	22	23	24	25	26	27	28	29	30	31		

□ 编带 (Taping Package):

- b 式 (引线间距 $F=5.0\text{mm}$, 产品间距 $P=P_0=12.7\text{mm}$)

Type b (lead spacing $F=5.0\text{mm}$, Product spacing $P=P_0=12.7\text{mm}$)

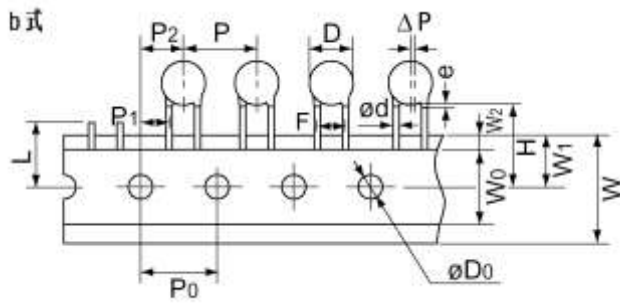

- b 式 (引线间距 $F=7.5\text{mm}$, 产品间距 $P=P_0=15.0\text{mm}$)

Type b (lead spacing $F=7.5\text{mm}$, Product spacing $P=P_0=15.0\text{mm}$)

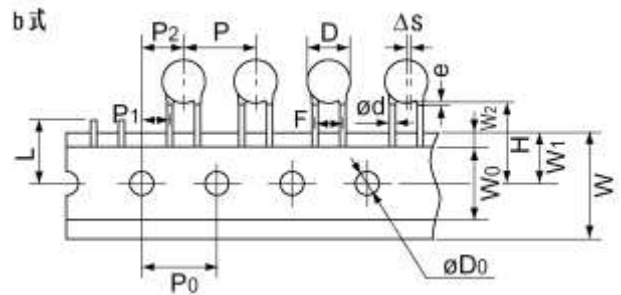
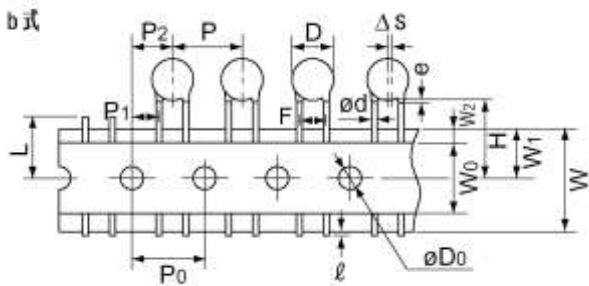

注: 左侧编带图为一次编带, 右侧编带图为二次编带 (left banding diagram is primary banding ;right banding diagram is secondary banding.)

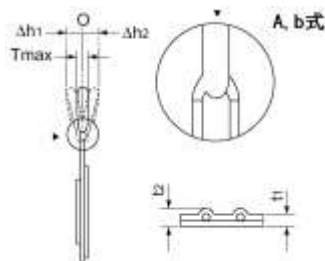

项目 Item	代号 Code	Dimensions (mm)	
引线间距 Lead spacing	F	7.5±1.0	5.0±0.6
产品间距 Pitch of component	P	15.0±1.0	12.7±0.5
传送孔间距 Pitch of sprocket hole	P0	15.0±0.3	12.7±0.3
传送孔位置偏差 Position of sprocket hole	P1	3.75±0.7	3.85±0.7
	P2	7.5±1.3	6.35±1.3
引线线径 Lead diameter	d	0.55±0.055	
产品倾倒 Deviation across tape	Δ h	0±2.0max	
纸带宽度 Carrier tape width	W	18.0±0.5	
胶带宽度 Hold-down tape width	W0	6.0min	
传送孔位置偏差 Position of sprocket hole	W1	9.0±0.5	
胶带偏差 Hold-down tape distortion	W2	1.5±1.5	
产品至纸带中心位置 Lead distance between reference and bottom planes	H	20±2	
传送孔孔径 Diameter of sprocket hole	D0	4.0±0.2	
不良切断位置 Portion to cut	L	11.0+0/-1.0	
封装料垂延 Coating extension on lead	e	3.5max	
纸带厚度 thickness of tape	t1	0.5±0.3	
	t2	1.5max	
引线弹性弯曲 Lead flexible blend	Δ S(Δ P)	0±2.0	
引线尾端长度 Lead the end of length	ℓ	1.0max	

□结构(Structure)

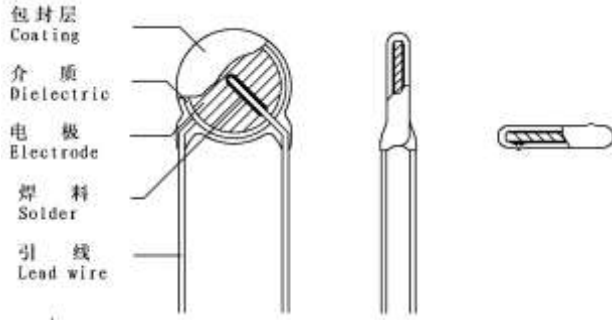

包封层(Coating) : 环氧树脂(Epoxy Resin)

介 质(Dielectric): 陶 瓷 (Ceramic)

电 极(Electrode : 银 (Silver)

焊 料(Solder) : 锡(Alloy Tin)

引 线(Lead Wire) : 镀锡引出线(Lead)

□主要材料(Main Material)

SrCO₃ BaCO₃ TiO₂ Bi₂O₃ CaCO₃ Nb₂O₅ MgO

银膏(Silver paste) 环氧树脂(Epoxy Resin)

□室内条件(Room Condition)

温度(Temp.): 15~35℃ 相对湿度(R.H.): 45~75%

气压(Atm pressure): 86~106kPa(860~1060mbar)

□测试条件(Test Condition)

温度(Temp.): 常规测试 (Routine test): 15~35℃,

有疑义时测试 (Test in case of disagreement): 20±2℃

相对湿度(R.H.): 45~75%

电压(Vol.): 1.0±0.2Vrms 频率(Freq.): 1±0.2KHz

□容量—温度变化曲线 Cap.—Temp. Curve

2B4

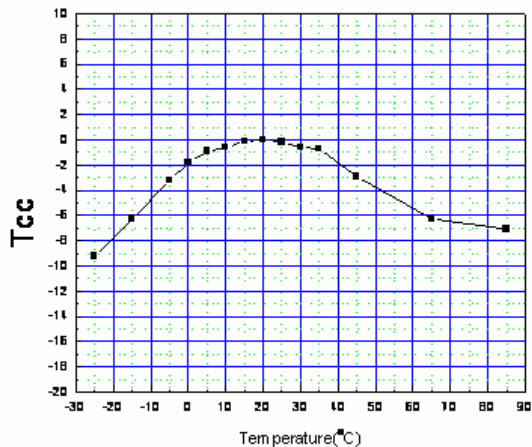

□型号命名方法 Part Code Designation

CT81—2KV—06 b—2B4—221 K—1 T1
 ① ② ③ ④ ⑤ ⑥ ⑦ ⑧ ⑨

①种类 Class

代码 Code	种类 Class
CT81	Ⅱ类高压 Class II High-Voltage

⑤温度特性 Temperature Characteristic

代码 Code	容量变化 Cap. Change
2B4	-10~+10%

②额定电压 Rated Voltage

代码 Code	额定电压 Rated Vol.	代码 Code	额定电压 Rated Vol.
2KV	2000V. DC		
6KV	6000V. DC		

⑥标称容量 Rated Capacitance

代码 Code	静电容量 Capacitance	代码 Code	静电容量 Capacitance
101	100pF	221	220pF
以此类推 And so on			

③主体外径 Body Diameter

代码 Code	最大外径 Max Diameter of Body	代码 Code	最大外径 Max Diameter of Body
06	6.5mm		
07	7.5mm		

⑦容量允差 Tolerance

代码 Code	容量允差 Tolerance
K	± 10%

④引线形式 Lead Shape

代码 Code	形式 Shape
b	直脚 Straight

⑧引线间距 Lead spacing

代码 Code	间距 spacing
1	5.0mm
2	7.5mm
3	10.0mm

⑨包装方式 package Shape

代码 Code	形式 Shape
T1	P0=12.7mm P=12.7mm
T2	P0=12.7mm P=25.4mm
T3	P0=15.0mm P=15.0mm

□ 编带包装 (Taping Package packing)

1、包装数量 (packing quantity):

引线间距 Lead spacing	包装盒分类 Kinds of plastic box	成型方式 Molding mode	包装数量 Quantity per bag	备注 Remark
F=5.0mm	1# 2#	b	2000	包装盒尺寸: Size of plastic box 1#: 336×240×45mm 2#: 336×290×48mm
F=7.5mm	1# 2#	b	1000~2000	

2、包装标识 (packing marking):

示例(Example)	项 目 (Item)	
		公司商标 (Manufacturer's Marking)
		环保标识 RoHS Designation
	物料编码 Code	用户要求时 When the customer require
	规格型号 Model	详见如上表格, (Please see the detail in the upper sheet)
	生产批号 Product lots	生产批号 Product lots
	成型代号 lead shape	用户要求时 When the customer require
	生产日期 Productive date	产品生产时间 the produce time of the product
	数 量 Quantity	每盒的包装数量 the packing quantity per plastic bag

3、外包装 (over-wrap packing):

外包装箱 (over-wrap boxes) (B1:520×370×280mm、B2:358×312×275mm)

装箱数量应为最小包装的整数倍。(The packing quantity should be integral multiple of minimal packaging.)

□规格及试验方法 Specification and Test Method

项 目 ITEM		规 格 SPECIFICATION	试 验 方 法 及 条 件 TEST METHOD AND CONDITION									
1. 存储温度范围 Storage Temp. Range		-40℃~+ 85℃										
2. 使用温度范围 Operating Temp. Range		-25℃~+ 85℃										
3. 外观尺寸 Appearance and Dimension		外观无可见损伤 尺寸在规格内 Appearance has no marked defect. Dimensions shall be within specified tolerance.	外观用目视法观测 尺寸用游标卡尺测量 Appearance be watched on sight Dimension be measured by caliper									
4. 标识 Mark		应清晰可见 Should be discerned easily.	用目视法观测 Be watched on sight									
5. 静电容量 Capacitance		在规格范围内 Within specified tolerance	温度 Temp. 20±2℃ 电压 Vol. 1.0±0.2Vrms 频率 Freq. 1±0.1KHz									
6. 损耗因数 Dissipation Factor		B: 2.5%max	同上 Same condition as capacitance									
7. 绝缘电阻 Insulation Resistance		大于 10,000MΩ 10,000MΩmin	500±50V. DC 的电压充电一分钟。 The insulation Resistance shall be measured with 500±50V. DC within 60±5 sec of charging.									
8. 耐电压 Dielectric Strength	端子间 Between Lead Wires	无不良 No failure.	端子间施加 200%的额定电压一分钟。(6KV:150%) (充放电电流<50mA) Apply a DC voltage of 200% of the rated voltage for 1 min. (Charge/discharge current<50mA) (6KV:150%)									
	端子与外壳间 Body Insulation	无不良 No failure.	如图, 将电容器的引线连在一起, 主体外紧包一层金属箔, 边沿距引线 3-4mm, 在电容器引线和金属箔间施加 200%的额定电压一分钟。(充放电电流<50mA) (6KV:150%) The terminals of the capacitor shall be connected together, A metal foil shall be closely wrapped around the body of the capacitor to the distance of about 3-4 mm from each terminal, A voltage of 200% of the rated is applied between the capacitor lead wires and the metal balls for 1 min. (Charge/discharge current<50mA) (6KV:150%)									
9. 温度特性 Temp. Char.	Ct - C3 C3	B: -10~+10%	静电容量测试须依下列顺序测试。 试验前: 电容器应放置在 85±2℃ 的温度下 1 小时, 然后在常温下恢复 24±2 小时后测试。 The capacitance measurement shall be made at each step specified as following. Capacitance change from the volume of step 1 shall not exceed the limit specified. pre-treatment: The capacitor shall be placed at 85±2℃ for 1 hour, then placed at room condition for 24±2 hours before initial measurement.									
			<table border="1"> <thead> <tr> <th>步骤 (Step)</th> <th>①</th> <th>②</th> <th>③</th> <th>④</th> <th>⑤</th> </tr> </thead> <tbody> <tr> <td>温度 (Temp.)</td> <td>20±2℃</td> <td>-25±2℃</td> <td>20±2℃</td> <td>85±2℃</td> <td>20±2℃</td> </tr> </tbody> </table>	步骤 (Step)	①	②	③	④	⑤	温度 (Temp.)	20±2℃	-25±2℃
步骤 (Step)	①	②	③	④	⑤							
温度 (Temp.)	20±2℃	-25±2℃	20±2℃	85±2℃	20±2℃							

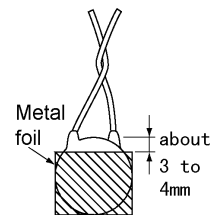

项 目 ITEM	规 格 SPECIFICATION		试 验 方 法 及 条 件 TEST METHOD AND CONDITION															
10. 端子强度 Strength of Lead Wires (c 式不做此 项 Type c none)	抗拉强度 Pull	导线不断裂 电容器不破损 Lead wire shall not cut off and capacitor shall not be damaged	把制品固定,在端子引出方向施加负荷 10N 保持 10±1 秒。 Fix the body of the capacitor and apply a tensile weight gradually to each lead wire in the radial direction of capacitor up to 10N, and keep it for 10±1sec. 															
	弯曲强度 Bending	shall not be damaged	在端子间施加 5N 负荷并弯曲 90°, 回复原后反向弯曲 90°, 每次弯曲时间为 2 至 3 秒, 连续 2 次。 Each lead wire shall be subjected to 5N weight and then a 90° bend, at the point of egress, in one direction return to original position, and then a 90° bend in the opposite direction at the rate of one bend in 2-3 s for 2times.															
11. 耐焊接热 Soldering Effect	外观 Appearance	无显著异常 No marked defect	将端子浸入温度为 260±5℃ 的熔锡内,外保留 1.5-2.0mm 距离主体边缘,并保持 5.0±0.5 秒。 试验前: 电容器应放置在 85±2℃ 的温度下 1 小时, 然后在常温下恢复 24±2 小时后测试。 试验后: 室内条件下恢复 24±2 小时。															
	容量变化 Capacitance Change	B: ±10%max	The lead wires shall be immersed into the melted solder of 260±5℃ up to about 1.5 to 2.0 mm from the main body for 5.0±0.5 sec. Pre-treatment: The capacitor shall be placed at 85±2℃ for 1 hour, then placed at room condition for 24±2 hours before initial measurement. Post-treatment: Capacitor shall be stored for 24±2 hours at room condition. 															
12. 温度循环 Temp. Cycling	外观 Appearance	无显著异常 No marked defect	将电容器放入高低温箱, 按下列步骤循环 5 次。 试验前: 电容器应放置在 85±2℃ 的温度下 1 小时, 然后在常温下恢复 24±2 小时后测试。 试验后: 在室内条件下恢复 24±2 小时测试。															
	容量变化 Capacitance Change	B: ±10%max	The capacitor shall be introduced into the test chamber, and shall be exposed to the temperature conditions as shown in table at 5 cycles. pre-treatment: The capacitor shall be placed at 85±2℃ for 1 hour, then placed at room condition for 24±2 hours before initial measurement. Post-treatment: Capacitor shall be stored for 24±2 hours at room conditions. <table border="1" data-bbox="715 1317 1481 1429"> <thead> <tr> <th>步骤(STEP)</th> <th>1</th> <th>2</th> <th>3</th> <th>4</th> </tr> </thead> <tbody> <tr> <td>温度(TEMP.)</td> <td>-25±3℃</td> <td>20±2℃</td> <td>85±3℃</td> <td>20±2℃</td> </tr> <tr> <td>时间(TIME)</td> <td>30±3min.</td> <td>3min. max</td> <td>30±3min.</td> <td>3min. max</td> </tr> </tbody> </table>		步骤(STEP)	1	2	3	4	温度(TEMP.)	-25±3℃	20±2℃	85±3℃	20±2℃	时间(TIME)	30±3min.	3min. max	30±3min.
步骤(STEP)	1	2	3	4														
温度(TEMP.)	-25±3℃	20±2℃	85±3℃	20±2℃														
时间(TIME)	30±3min.	3min. max	30±3min.	3min. max														
13. 耐振性 Vibration Resistance	外观 Appearance	无显著异常 No marked defect	电容器须焊锡固定好,固定点距电容器主体 3±1.0mm, 并经 10Hz→500Hz 之振动频率,全振幅 1.5mm, 振动时间为 6 小时, 往 X、Y、Z 轴三个方向(各 2 小时)。 试验前: 电容器应放置在 85±2℃ 的温度下 1 小时, 然后在常温下恢复 24±2 小时后测试。 试验后: 在室内条件下恢复 24±2 小时测试。															
	容量变化 Capacitance Change	B: ±10%max	The capacitor shall firmly be soldered to the supporting lead wires about 3±1.0 mm from the body of the capacitor and vibration which is 10 to 500Hz in the vibration frequency range, 1.5mm in total amplitude, for a total of 6 hours, 2 hours each in three mutually perpendicular directions. pre-treatment: The capacitor shall be placed at 85±2℃ for 1 hour, then placed at room condition for 24±2 hours before initial measurement. Post-treatment: Capacitor shall be stored for 24±2 hours at room conditions. 															
14. 易焊性 Solder ability of lead wires	导线上沾锡面积大于 90%。 Lead wire shall be soldered with uniformly coated on the axial direction over 90% of the circumferential direction.		导线须浸入助焊剂后再浸入 245±5℃ 的熔锡内, 松香浓度 25%wt, 距离主体 2.0~2.5mm, 时间 2±0.5 秒。 The lead wires of the capacitor shall be dipped into a alcohol solution of 25% wt rosin and then into molten solder of 245±5℃ for 2±0.5 sec. In both case the depth of dipping is up to about 2.0 to 2.5 mm from the root of the lead wires.															

项目 ITEM	规格 SPECIFICATION		试验方法及条件 TEST METHOD AND CONDITION
15. 碰撞试验 Collision Resistance	外观 Appearance	无显著异常 No marked defect	电容器须焊锡固定好, 固定点距电容器主体 $3 \pm 1.0\text{mm}$, 并施加一加速度为 390m/s^2 , 脉冲时间为 6ms 的碰撞, 次数为 4000 次。 试验前: 电容器应放置在 $85 \pm 2^\circ\text{C}$ 的温度下 1 小时, 然后在常温下恢复 24 ± 2 小时后测试。 试验后: 在室内条件下恢复 24 ± 2 小时测试。 The capacitor shall firmly be soldered to the supporting lead wire about $3 \pm 1.0\text{mm}$ from the body of the capacitor and a collision which is 390m/s^2 in the acceleration, 6ms in the pulse cycle for 4000 times. pre-treatment: The capacitor shall be placed at $85 \pm 2^\circ\text{C}$ for 1 hour, then placed at room condition for 24 ± 2 hours before initial measurement. Post-treatment: Capacitor shall be stored for 24 ± 2 hours at room conditions.
	容量变化 Capacitance Change	B: $\pm 10\%\text{max}$	
16. 湿热循环 Humidity Cycling	外观 Appearance	无显著异常 No marked defect	电容器在温度 $40 \pm 2^\circ\text{C}$, 湿度 $95 \pm 3\%\text{RH}$ 下放置 8 小时, 室温下放置 16 小时, 循环 5 次。 试验后: 在室内条件下恢复 1 至 2 小时。 Set the capacitor for 8 hours at $40 \pm 2^\circ\text{C}$ in $95 \pm 3\%\text{RH}$, then placed at room condition for 16 hours, circulating for 5 times. Post-treatment: The capacitor shall be stored for 1 to 2 hours at room condition.
	容量变化 Capacitance Change	B: $\pm 10\%\text{max}$	
	损耗因数 D. F.	B: $5.0\%\text{max}$	
	绝缘电阻 I. R.	大于 $2500\text{M}\Omega$ $2500\text{M}\Omega\text{min}$	
17. 耐湿性 Humidity (Under Steady State)	外观 Appearance	无显著异常 No marked defect	电容器在温度 $40 \pm 2^\circ\text{C}$, 湿度 $95 \pm 3\%\text{RH}$ 下放置 500 ± 12 小时。 试验前: 电容器应放置在 $85 \pm 2^\circ\text{C}$ 的温度下 1 小时, 然后在常温下恢复 24 ± 2 小时后测试。 试验后: 在室内条件下恢复 24 ± 2 小时。 Set the capacitor for 500 ± 12 hours at $40 \pm 2^\circ\text{C}$ in $95 \pm 3\%\text{RH}$. pre-treatment: The capacitor shall be placed at $85 \pm 2^\circ\text{C}$ for 1 hour, then placed at room condition for 24 ± 2 hours before initial measurement. Post-treatment: The capacitor shall be stored for 24 ± 2 hours at room condition.
	容量变化 Capacitance Change	B: $\pm 10\%\text{max}$	
	损耗因数 D. F.	B: $5.0\%\text{max}$	
	绝缘电阻 I. R.	大于 $2500\text{M}\Omega$ $2500\text{M}\Omega\text{min}$	
18. 寿命试验 Life Test	外观 Appearance	无显著异常 No marked defect	施加 150% 的额定电压并在 $85 \pm 2^\circ\text{C}$ 下放置 1000 小时。(充放电电流限于 50mA 以下) 试验前: 电容器应放置在 $85 \pm 2^\circ\text{C}$ 的温度下 1 小时, 然后在常温下恢复 24 ± 2 小时后测试。 试验后: 在室内条件下恢复 24 ± 2 小时。 Apply a DC voltage of 150% of the rated voltage for 1000 hours at $85 \pm 2^\circ\text{C}$. (Charge/discharge current $\leq 50\text{mA}$). pre-treatment: The capacitor shall be placed at $85 \pm 2^\circ\text{C}$ for 1 hour, then placed at room condition for 24 ± 2 hours before initial measurement. Post-treatment: Capacitor shall be stored for 24 ± 2 hours at room condition
	容量变化 Capacitance Change	B: $\pm 20\%\text{max}$	
	损耗因数 D. F.	B: $5.0\%\text{max}$	
	绝缘电阻 I. R.	大于 $4000\text{M}\Omega$ $4000\text{M}\Omega\text{min}$	