

Features

- ◆ Ultra low capacitance: 0.18 pF typical (I/O to GND)
- ◆ Ultra low leakage: nA level
- ◆ Breakdown Voltage: 6.4 V (typ)
- ◆ Low clamping voltage
- ◆ Complies with following standards:
 - IEC 61000-4-2 (ESD) immunity test
Air discharge: ±20kV
Contact discharge: ±15kV
 - IEC61000-4-4 (EFT) 80A (5/50ns)
 - IEC61000-4-5 (Lightning) : 3 A(8/20µs)
- ◆ ROHS Compliant

Ordering Information

Part Number	Qty per Reel	Reel Size
TPD1E01B04DPLR-TP	3000	7"

Mechanical Characteristics

- ◆ Package: X2SON
- ◆ Ultra low leakage: nA level
- ◆ Case Material: "Green" Molding Compound.
- ◆ UL Flammability Classification Rating 94V-0
- ◆ Moisture Sensitivity: Level 3 per J-STD-020
- ◆ Terminal Connections: See Diagram Below

Applications

- ◆ USB Type-C
- ◆ Thunderbolt 3
- ◆ Set-Top Boxes
- ◆ DisplayPort 1.3
- ◆ PCI Express 3

Dimensions and Pin Configuration

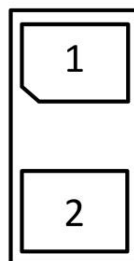

Marking:



R = Specific Device Code
M = Date Code

Absolute Maximum Ratings (Tamb=25°C unless otherwise specified)

Parameter	Symbol	Value	Unit
Peak Pulse Power (8/20μs)	Ppk	30	W
Peak Pulse Current (8/20μs)	IPP	3	A
ESD per IEC 61000-4-2 (Air)	VESD	± 20	kV
ESD per IEC 61000-4-2 (Contact)		± 15	
Operating Temperature Range	TJ	-55 to +125	°C
Storage Temperature Range	Tstg	-55 to +150	°C

Electrical Characteristics (TA=25°C unless otherwise specified)

Parameter	Symbol	Min	Typ	Max	Unit	Test Condition
Reverse Working Voltage	VRWM	-3.6		3.6	V	IIO < 10 nA
Breakdown Voltage	VBR	5.5	6.4	7.5	V	IT = 1mA, any I/O pin to ground
Breakdown Voltage	VBR	-5.5	-6.4	-7.5	V	IT = 1mA, any ground pin to I/O
Reverse Leakage Current	IR			10	nA	VIO = ± 2.5V any I/O pin to ground
Dynamic resistance	RDYN		0.47		Ω	any I/O pin to ground
Clamping Voltage	VC		7.2		V	IPP = 1A (8 x 20μs pulse), any I/O pin to ground
Clamping Voltage	VC		9		V	IPP = 3A (8 x 20μs pulse), any I/O pin to ground
Junction Capacitance	CJ		0.18		pF	VR = 0V, f = 1MHz, between I/O pins

Characteristic Curves

Fig1. 8/20µs Pulse Waveform

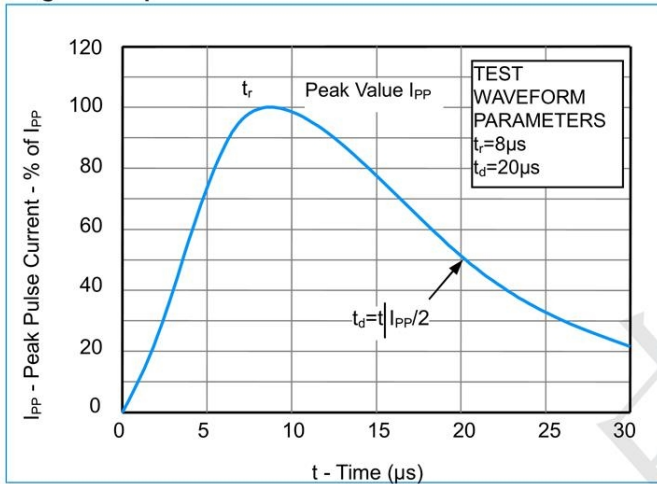

Fig2. ESD Pulse Waveform (according to IEC 61000-4-2)

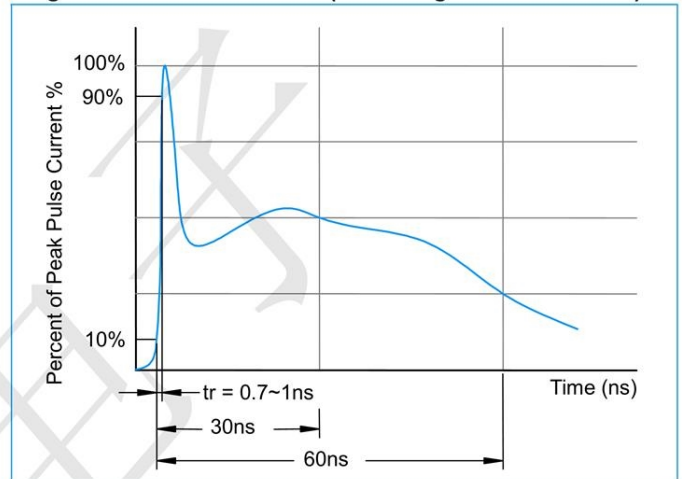
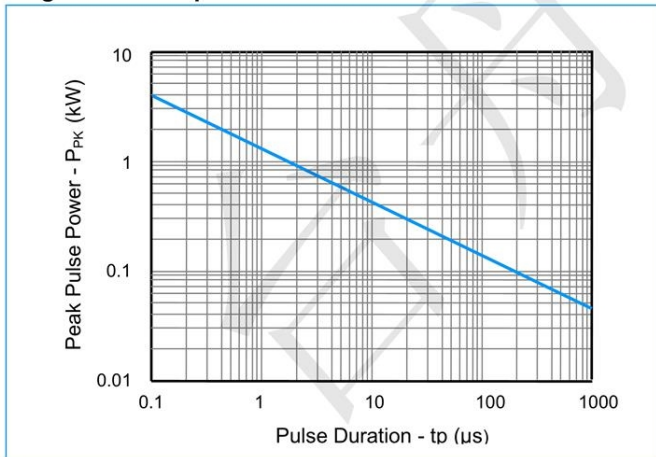
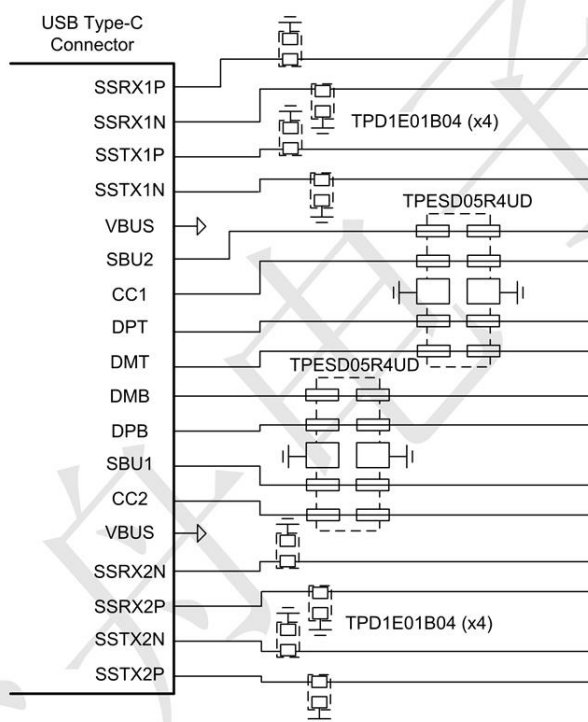

Fig3. Non - Repetitive Peak Pulse Power vs. Pulse Time



Application Information



X2SON Package Outline Drawing (0201)

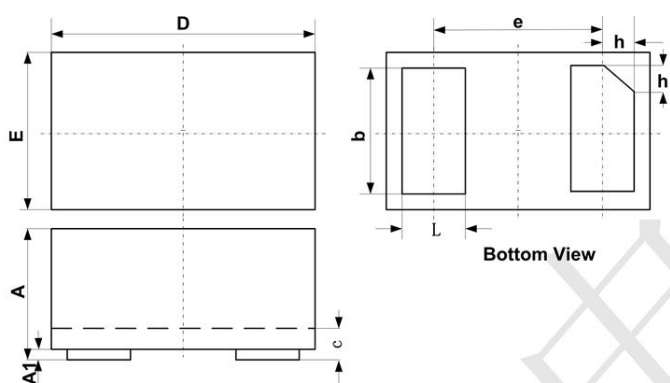

SYM	DIMENSIONS		
	MILLIMETERS		
	MIN	NOM	MAX
A	0.230	0.300	0.330
A1	0.000	0.020	0.050
b	0.215	0.245	0.275
c	0.120	0.150	0.180
D	0.550	0.600	0.650
e	0.355 BSC		
E	0.250	0.300	0.350
L	0.160	0.190	0.220
h	0.079 BSC		

Suggested Land Pattern

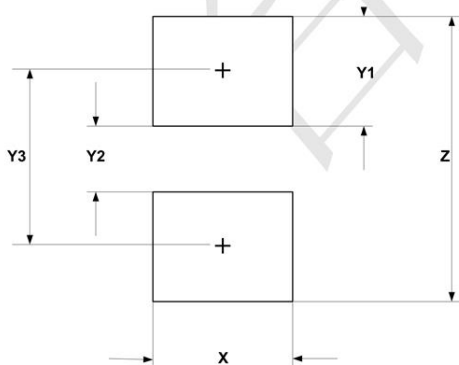

SYM	DIMENSIONS	
	MILLIMETERS	INCHES
X	0.60	0.024
Y1	0.50	0.020
Y2	0.30	0.012
Y3	0.80	0.032
Z	1.30	0.052