

TSD025*****

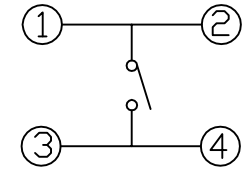

电路图
CIRCUIT DIAGRAM

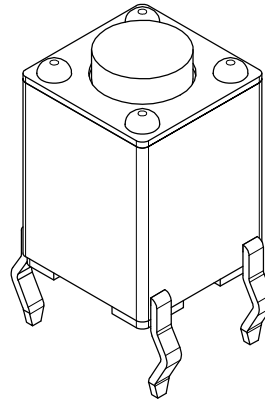
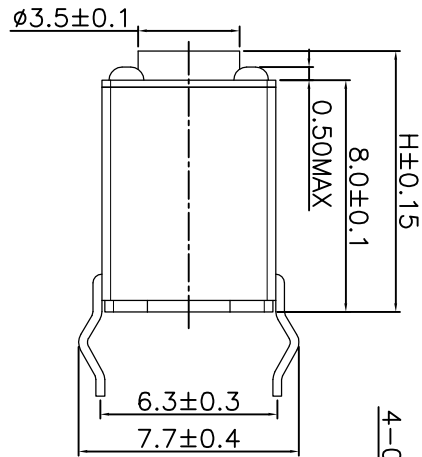
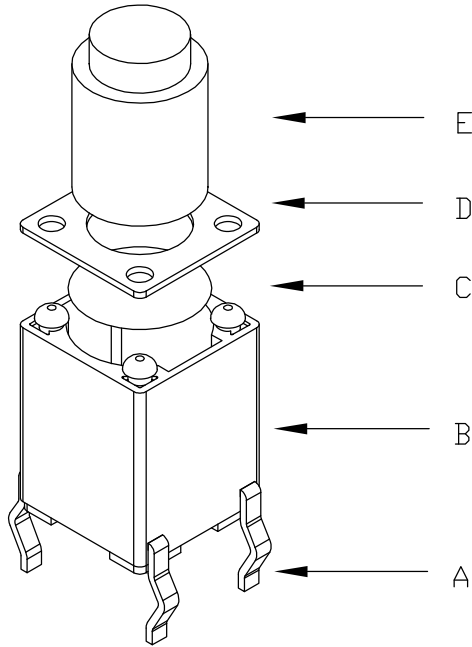
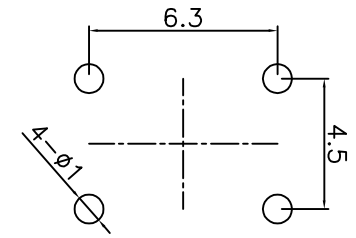

PCB. 焊接图
PCB. WELDING DRAWING

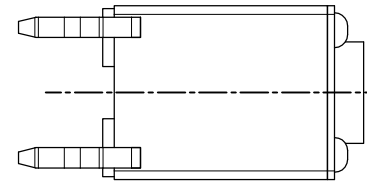
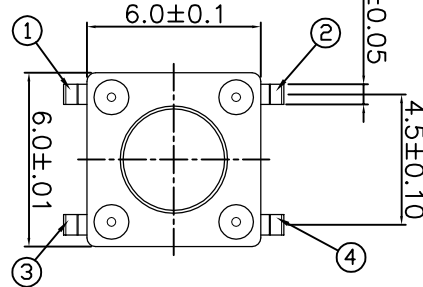

主要技术参数、性能

The Main Thchnology Performance

额定电流、电压 Rate voltage,current	50mA DC12V
接触电阻 Contact resistance	$\leq 100\text{m}\Omega$
按力 Operating force	$\pm 50\text{gf}$
行程 Travel	$0.20 \pm 0.10\text{mm}$
绝缘电阻 Insulated resistance	$\geq 100\text{M}\Omega$
介电强度 Dielectric strength	$\geq 250\text{VAC}/1\text{min}$

T S D 0 2 5

寿命:
A: ≥ 300000 次
B: ≥ 1000000 次
C: ≥ 3000000 次

高度H:
110: 11.0H
115: 11.5H
120: 12.0H
125: 12.5H
130: 13.0H
...

力度:
18: 180g
26: 260g
35: 350g

包装方式:
A: 散件

E	按钮	PPA	1	黑色
D	盖板	铁盖板	1	镀铜锡
C	弹片	不锈钢	1	镀银
B	本体	PPA	1	黑色
A	卡件	黄铜	1	镀银
项目 ITEM	名称 DESCRIPTION	材质 MATERIAL	数量 QTY	表面处理/颜色 FINSH/COLOR

					第一视角 FIRST VIEW			名称/NAME: 轻触开关 TACTILE SWITCH	
								型号/MODEL: TSD025*****	
标记 SING	处数 FREQUENCY	更改文件号 REVISION	签名 APPROVED	日期 DATE	比例 SCALE	1:1	一般公差 GENERAL TOLERANCE		
设计 DESIGN	朱元隆		2021.06.01		单位 UNIT	mm	$\geq 0-2 <$	± 0.10	BZCN 浙江博众电气有限公司 ZHEJIANG BOZHONG ELECTRONIC CO., LTD.
审核 CHECKED	赵晓峰		2021.06.01		重量 WEIGHT		$\geq 2-5 <$	± 0.25	
批准 APPROVED	陈乐峰		2021.06.01				≥ 5	± 0.30	
							角度 ANGLE	$\pm 0.5^\circ$	