

NOTE:

- 1.Rating1:DC12V 3A
Rating2:48V DC/125V AC/250V AC 0.1A
- 2.Operating proce: 110gf MAX
- 3.Electric Life:100,000
- 4.Mechanical Life:500,000
- 5.Ingress protection:IP67

⑧	Handle	—	1	SUS	—	—
⑦	Shrapnel	—	1	Brass	Plating silver	—
⑥	Contact	—	1	Ag	—	—
⑤	Sealed Circle	—	1	Silicone Rubber	—	—
④	Terminal	—	2	Brass(0.50t)	Plating silver	—
③	Plunger	—	1	POM	Black	—
②	Case	—	1	PA	Black	—
①	Cover	—	1	PA	Black	—
ITEM	PART NAME	TER'NO.	QTY.	MATERIAL	FINISHING	REMARK

APPROVALS		DATE		 ELECTRONICS CO.,LTD		
DRAWN	LIUCAN	2021.8.2				
CHECKED				PART NO.	K9-2841R-6HDP	
APPROVALS				TOLERANCES ARE	ANGLE	UNIT: mm SCALE: 1:1 PROJ:
		30~以上	±0.30		±2'	DRAWING NO. SHEET 1 OF 1
		10~30	±0.20			
		5~10	±0.15			
		~ 5	±0.10			

ECN NO.	REV.	DATE.	DESCRIPTION.	CHANGE.	CHECK.	APPRO.
	A		NEW			

K9-284□选型表

K9-2841N-1SDA-1A





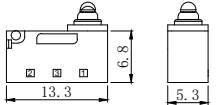





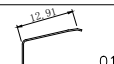

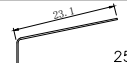
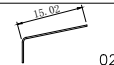
开关系列	名称
K9	防水微动开关

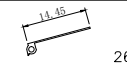
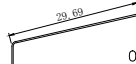

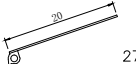

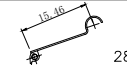
编码	线材长度L	编码	线材长度L
0	无线材省略	C	250mm
A	150mm	D	300mm
B	200mm	其它	...

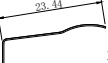
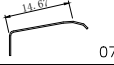
编码	图示	产品规格
4		D型 13.3*5.3*6.8(帽型导芯)













流水号	电线规格	流水号	电线规格
0	无线材省略	5	0.14mm2*6C
1	UL1007 22AWG美标	6	UL1007 24AWG美标
2	AVSS0.3日标	7	特氟龙24AWG
3	AVSS0.5日标	8	VW-1 1015 20AWG
4	UL1007 20AWG美标	9	UL2468 24AWG VW-1 80℃

编码	额定负载
1	3A 12V DC
	0.1A 125/250V AC
	0.1A 48V DC
2	10(1.5)A 250V AC

编码	手柄类型	编码	手柄类型	编码	手柄类型
A	 01	G	 08	R	 25
B	 02	H	 09	L	 26
C	 03	S	 18	P	 27
D	 05	Q	 19	M	 28
E	 06	J	 22	N	无手柄
F	 07	K	 23		











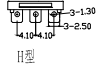
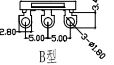
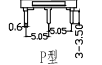
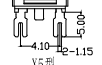
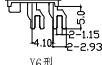
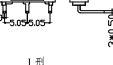
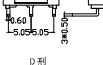
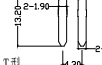









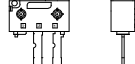



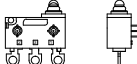

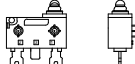
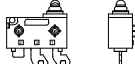

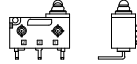
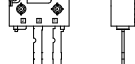

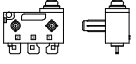
编码	图示	定位类型
N		无定位柱
R		右侧双定位柱
L		左侧双定位柱
D		两侧双定位柱
Q		其它

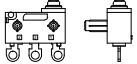
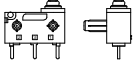
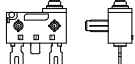
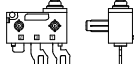
编码	定位柱长度L
0	无定位柱
1	1.5MM
2	2.0MM
3	2.5MM
4	3.0MM
5	3.5MM
6	5.0MM
7	1.3MM

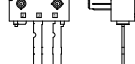
编码	端子类型	编码	端子类型
S		T	
H		E	
B		W	
P		X	
K		Y	
M			
L			
R			

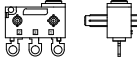
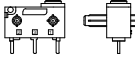
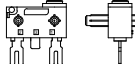
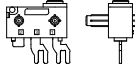
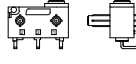

编码	触点类型
D	常开/常闭 SPDT
B	常开 SPST-NO
C	常闭 SPST-NC

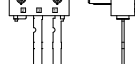
D型 选型表

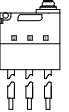
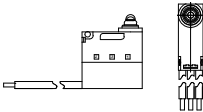
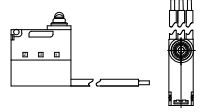
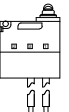
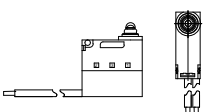
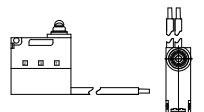
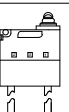
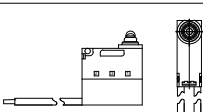
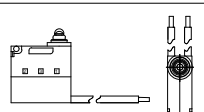
端子类型 定位柱类型		S型	H型	B型	P型	K型	M型	L型	R型	T型	其他/Other
											其他/Other
N											
R											
L											
D											
备注：定位柱长度"L"通常为1.5MM、2.0MM、2.5MM、3.0MM、3.5MM、5.0MM，也可根据客户需求定制长度											

端子类型 触点类型		W	X	Y
D 常开/常闭				
B 常开				
C 常闭				

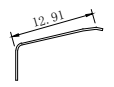
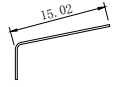
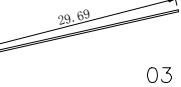
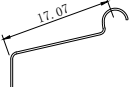
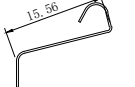
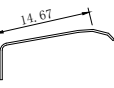
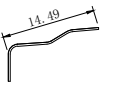
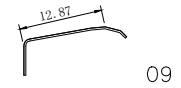
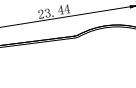
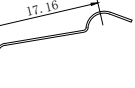
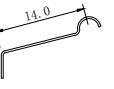
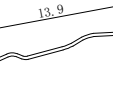
手柄类型

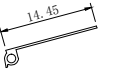
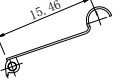
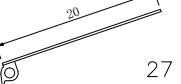
手柄	插入式	 01	 02	 03	 05	 06
		 07	 08	 09	 22	 23
	外扣式	 18	 19	 25		
		 26	 28	 27		