

ROHS

多种规格，可参考选型表

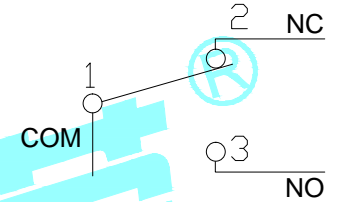

Circuit Diagram

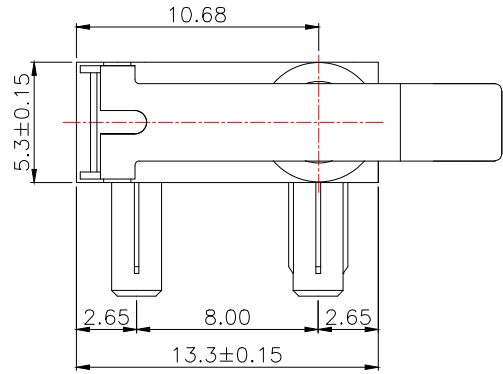
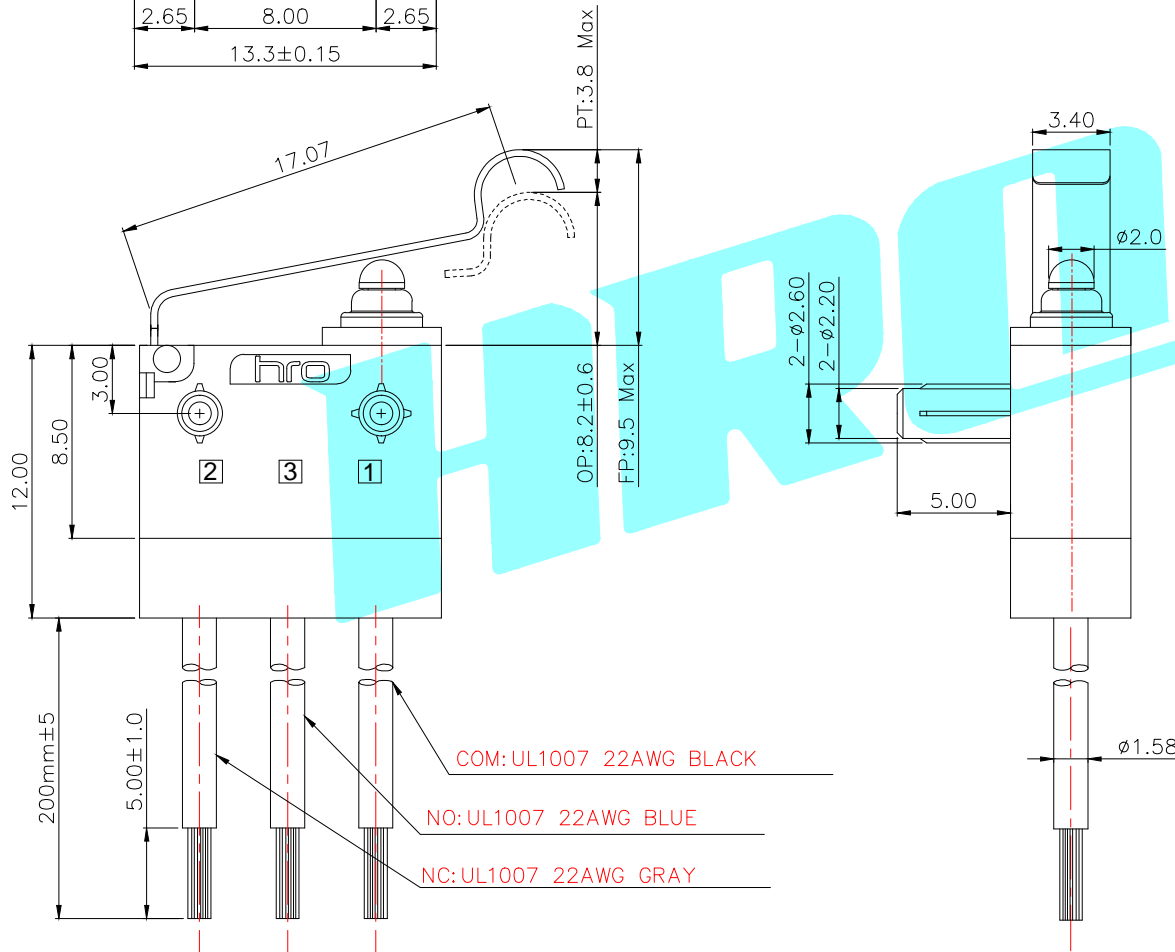

NOTE:

- 1.Rating1:DC12V 3A  
Rating2:48V DC/125V AC/250V AC 0.1A
- 2.Operating force:200gf MAX
- 3.Electric Life:100,000
- 4.Mechanical Life:500,000
- 5.Ingress protection:IP67

| ITEM | PART NAME     | TER'NO. | QTY. | MATERIAL        | FINISHING      | REMARK |
|------|---------------|---------|------|-----------------|----------------|--------|
| ⑧    | Handle        | —       | 1    | SUS             | —              | —      |
| ⑦    | Shrapnel      | —       | 1    | Brass           | Plating silver | —      |
| ⑥    | Contact       | —       | 1    | Ag              | —              | —      |
| ⑤    | Sealed Circle | —       | 1    | Silicone Rubber | —              | —      |
| ④    | Terminal      | —       | 3    | Brass(0.50t)    | Plating silver | —      |
| ③    | Plunger       | —       | 1    | POM             | Black          | —      |
| ②    | Case          | —       | 1    | PA              | Black          | —      |
| ①    | Cover         | —       | 1    | PA              | Black          | —      |

| APPROVALS |        | DATE      |       | HRO 韩荣®<br>ELECTRONICS CO.,LTD |                  |                           |
|-----------|--------|-----------|-------|--------------------------------|------------------|---------------------------|
| DRAWN     | LIUCAN | 2021.7.28 |       | TITLE:                         | MICRO SWITCHS    |                           |
| CHECKED   |        |           |       | PART NO.                       | K9-2841R-6WDD-1B |                           |
| APPROVALS |        |           |       | TOLERANCES ARE                 | ANGLE            | UNIT: mm SCALE: 1:1 PROJ: |
|           |        | 30~以上     | ±0.30 | ±2'                            | DRAWING NO.      | SHEET 1 OF 1              |
|           |        | 10~30     | ±0.20 |                                |                  |                           |
|           |        | 5~10      | ±0.15 |                                |                  |                           |
|           |        | ~ 5       | ±0.10 |                                |                  |                           |

| ECN NO. | REV. | DATE. | DESCRIPTION. | CHANGE. | CHECK. | APPRO. |
|---------|------|-------|--------------|---------|--------|--------|
|         | A    |       | NEW          |         |        |        |

# K9-284□选型表

## K9-2841N-1SDA-1A

| 开关系列 | 名称     |
|------|--------|
| K9   | 防水微动开关 |

| 编码 | 线材长度L | 编码 | 线材长度L |
|----|-------|----|-------|
| 0  | 无线材省略 | C  | 250mm |
| A  | 150mm | D  | 300mm |
| B  | 200mm | 其它 | ...   |

| 编码 | 图示  | 产品规格                  |
|----|---|-----------------------|
| 4  |  | D型 13.3*5.3*6.8(帽型导芯) |













| 流水号 | 电线规格           | 流水号 | 电线规格                  |
|-----|----------------|-----|-----------------------|
| 0   | 无线材省略          | 5   | 0.14mm2*6C            |
| 1   | UL1007 22AWG美标 | 6   | UL1007 24AWG美标        |
| 2   | AVSS0.3日标      | 7   | 特氟龙24AWG              |
| 3   | AVSS0.5日标      | 8   | VW-1 1015 20AWG       |
| 4   | UL1007 20AWG美标 | 9   | UL2468 24AWG VW-1 80℃ |

| 编码 | 额定负载             |
|----|------------------|
| 1  | 3A 12V DC        |
|    | 0.1A 125/250V AC |
|    | 0.1A 48V DC      |
| 2  | 10(1.5)A 250V AC |

| 编码 | 手柄类型   | 编码 | 手柄类型   | 编码 | 手柄类型   |
|----|--|----|--|----|--|
| A  |  01   | G  |  08   | R  |  25 |
| B  |  02   | H  |  09   | L  |  26 |
| C  |  03   | S  |  18   | P  |  27 |
| D  |  05   | Q  |  19   | M  |  28 |
| E  |  06  | J  |  22  | N  | 无手柄  |
| F  |  07 | K  |  23 |    |  |

| 编码 | 图示  | 定位类型   |
|----|---|--------|
| N  |  | 无定位柱   |
| R  |  | 右侧双定位柱 |
| L  |  | 左侧双定位柱 |
| D  |  | 两侧双定位柱 |
| Q  |   | 其它     |

| 编码 | 定位柱长度L |
|----|--------|
| 0  | 无定位柱   |
| 1  | 1.5MM  |
| 2  | 2.0MM  |
| 3  | 2.5MM  |
| 4  | 3.0MM  |
| 5  | 3.5MM  |
| 6  | 5.0MM  |
| 7  | 1.3MM  |

| 编码 | 端子类型  | 编码 | 端子类型  |
|----|---|----|---|
| S  |  | T  |  |
| H  |  | E  |  |
| B  |  | W  |  |
| P  |  | X  |  |
| K  |  | Y  |  |
| M  |  |    |   |
| L  |  |    |   |
| R  |  |    |   |

| 编码 | 触点类型       |
|----|------------|
| D  | 常开/常闭 SPDT |
| B  | 常开 SPST-NO |
| C  | 常闭 SPST-NC |

# D型 选型表

| 端子类型<br>定位柱类型  |   | S型  | H型  | B型  | P型   | K型  | M型  | L型  | R型  | T型  | 其他/Other |
|--|---|---|---|---|--|---|---|---|---|---|----------|
|  |   |  |  |  |  |  |  |  |  |  | 其他/Other |
| N  |  |  |  |  |  |  |  |  |  |  |          |
| R  |  |  |  |  |  |  |  |  |  |  |          |
| L  |  |  |  |  |  |  |  |  |  |  |          |
| D  |  |  |  |  |  |  |  |  |  |  |          |
| 备注：定位柱长度"L"通常为1.5MM、2.0MM、2.5MM、3.0MM、3.5MM、5.0MM，也可根据客户需求定制长度 |   |   |   |   |  |   |   |   |   |   |          |

| 端子类型<br>触点类型 |   | W   | X  | Y |
|--------------|---|---|--|---|
| D<br>常开/常闭   |  |  |  |   |
| B<br>常开      |  |  |  |   |
| C<br>常闭      |  |  |  |   |

## 手柄类型

|    |     |  |  |  |  |  |
|----|-----|--|--|--|--|--|
| 手柄 | 插入式 |  01 |  02 |  03 |  05 |  06 |
|    | 外扣式 |  07 |  08 |  09 |  22 |  23 |
|    |     |  18 |  19 |  25 |  |  |
|    |     |  26 |  28 |  27 |  |  |