

SS32AT THRU SS320AT

SURFACE MOUNT SCHOTTKY BARRIER RECTIFIERS

Forward Current-3.0A

Reverse Voltage-20V to 200V

FEATURES

- ◆ For surface mount applications
- ◆ High forward surge current capability
- ◆ Low power loss,high efficiency
- ◆ Metal silicon junction,majority carriers conduction

MECHANICAL DATA

- ◆ Case: SMA molded plastic body
- ◆ Terminals: Solderable per MIL-STD-750 , Method 2026
- ◆ Weight: Approximated 0.06 grams

PINNING

PIN	DESCRIPTION
1	Cathode
2	Anode

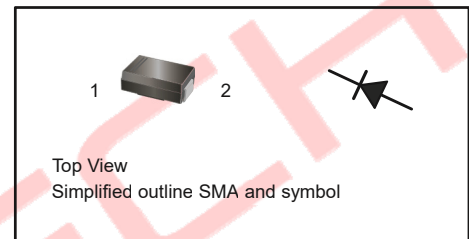

MAXIMUM RATINGS AND ELECTRICAL CHARACTERISTICS

Ratings at 25°C ambient temperature unless otherwise specified.

Single phase half-wave 60 Hz, resistive or inductive load, for capacitive load current derating by 20 %.

PARAMETER	SYMBOL	SS32AT	SS34AT	SS34AT	SS36AT	SS38AT	SS310AT	SS312AT	SS315AT	SS320AT	UNIT	
Maximum Repetitive Peak Reverse Voltage	V_{RRM}	20	40	45	60	80	100	120	150	200	V	
Maximum RMS Voltage	V_{RMS}	14	28	31.5	42	56	70	84	105	140	V	
Maximum DC Blocking Voltage	V_{DC}	20	40	45	60	80	100	120	150	200	V	
Maximum Average Forward Rectified Current at $T_C=75^\circ\text{C}$	$I_{F(AV)}$	3.0									A	
Peak Forward Surge Current (Note1)	I_{FSM}	80					70				A	
Maximum Forward Voltage at 3.0 A	V_F	0.55	0.70			0.85	0.95				V	
Maximum DC Reverse Current at Rated DC Blocking Voltage at $T_A=25^\circ\text{C}$ $T_A=100^\circ\text{C}$	I_R	0.5 5				0.3 3						mA
Typical Junction Capacitance (Note2)	C_J	450				400						pF
Typical Thermal Resistance (Note3)	$R_{\theta JA}$	70									$^\circ\text{C/W}$	
Operating and Storage Temperature Range	T_J, T_{STG}	-55 to +150									$^\circ\text{C}$	

Notes: 1. Measured at 8.3 ms single half sine wave superimposed on rated load (JEDEC Method).

2. Measured at 1MHz and applied reverse voltage of 4 V D.C.

3. P.C.B. mounted with 2.0" X 2.0" (5 X 5 cm) copper pad areas.

SS32AT THRU SS320AT

RATINGS AND CHARACTERISTIC CURVES

Fig.1 Forward Current Derating Curve

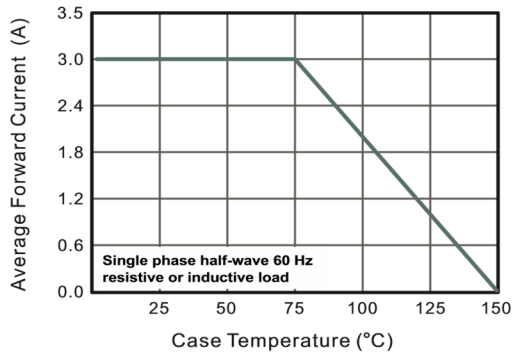

Fig.2 Typical Reverse Characteristics

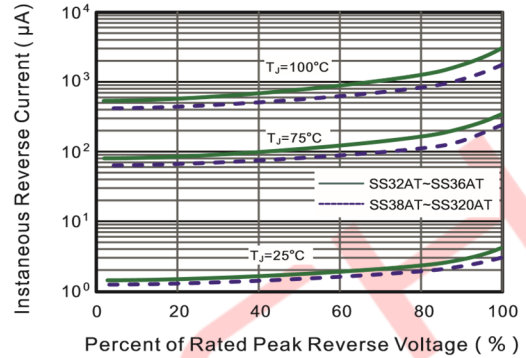

Fig.3 Typical Forward Characteristics

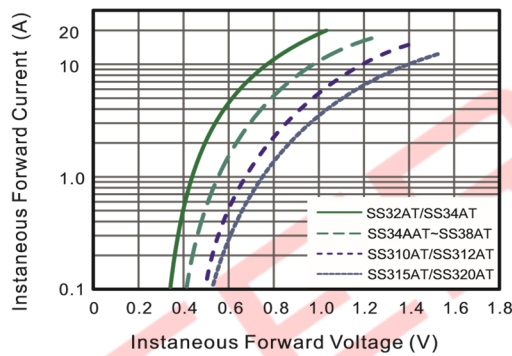

Fig.4 Typical Junction Capacitance

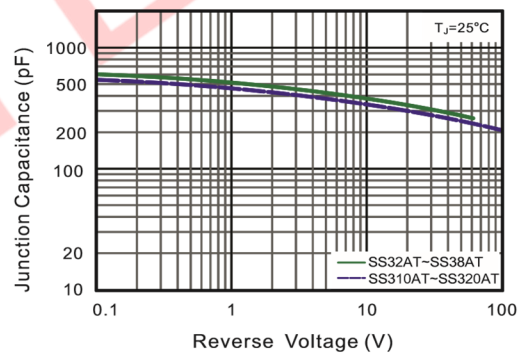

Fig.5 Maximum Non-Repetitive Peak Forward Surge Current

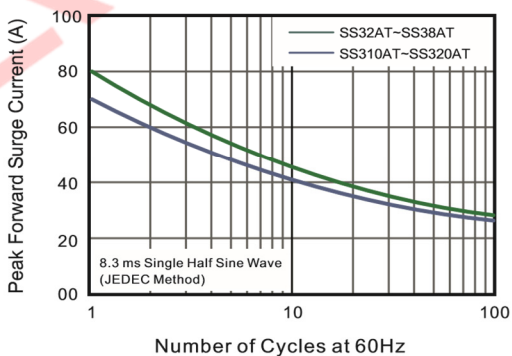
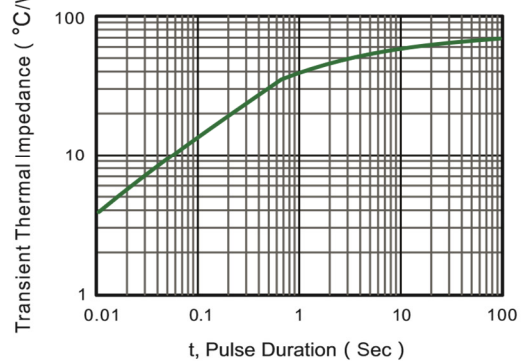

Fig.5- Typical Transient Thermal Impedance



SS32AT THRU SS320AT

PACKAGE OUTLINE

SMA

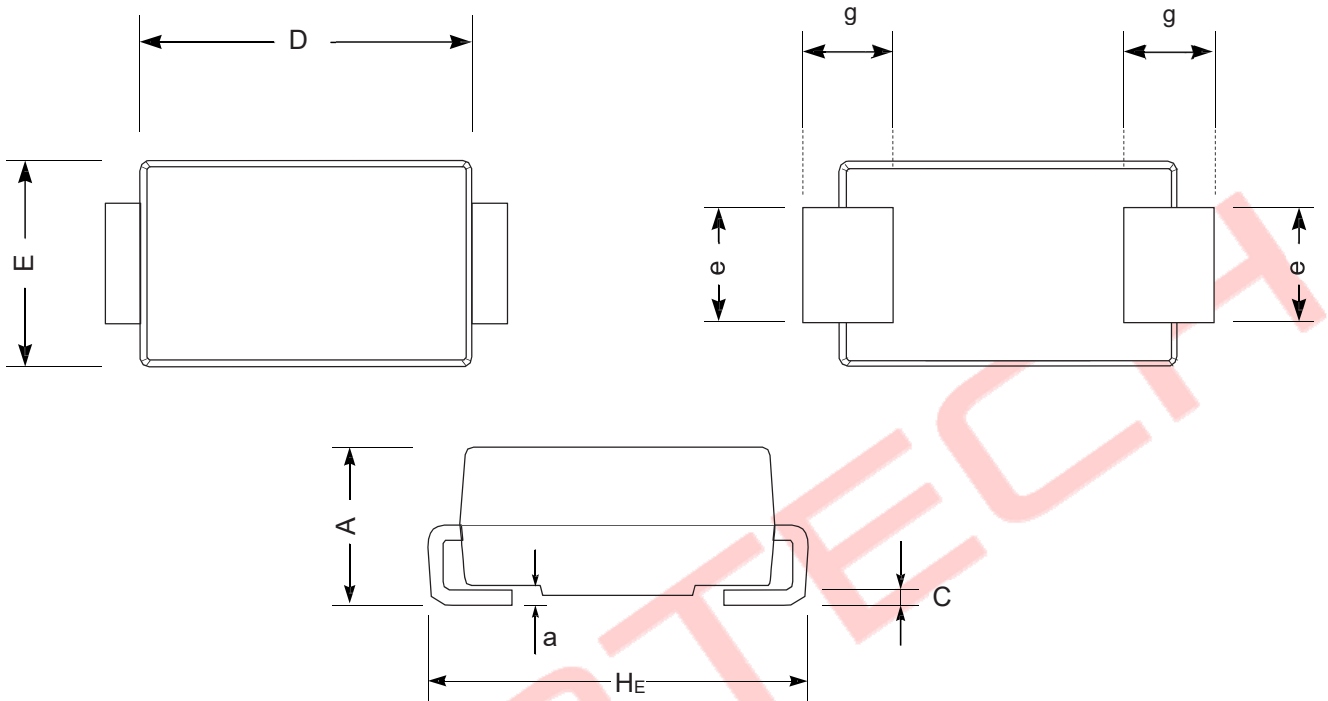

UNIT		A	D	E	HE	C	e	g	a
mm	max	2.2	4.5	2.7	5.2	0.31	1.6	1.5	0.3
	min	1.9	4.0	2.3	4.7	0.15	1.3	0.9	
mil	max	87	181	106	205	12	63	59	12
	min	75	157	91	185	6	51	35	

ORDERING INFORMATION

Device	Package	Shipping
SS32AT thru SS320AT	SMA	5,000/ Tape & Reel (13 inches)