





SOD-123 Plastic-Encapsulate Diodes

SD103AW-SD103CW Schottky Barrier Diode

FEATURES

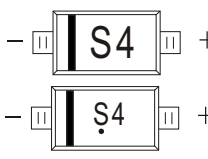
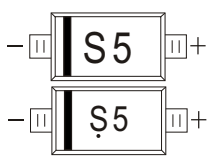
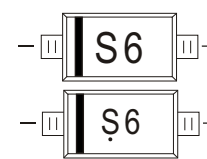
- Low Forward Voltage Drop
- Guard Ring Construction for Transient Protection
- Negligible Reverse Recovery Time
- Low Capacitance

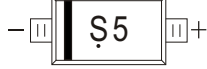
MARKING:

SD103AW:S4	SD103BW:S5	SD103CW:S6
		
		

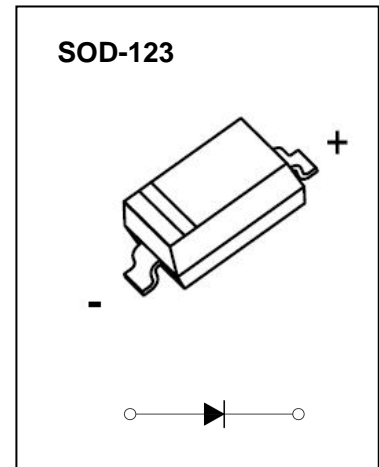

The marking bar indicates the cathode
 Solid dot = Green molding compound device, if none,
 the normal device.

MAXIMUM RATINGS ($T_a=25^\circ\text{C}$ unless otherwise noted)

Symbol	Parameter	Value			Unit
		SD103AW	SD103BW	SD103CW	
V_{RRM}	Peak Repetitive Reverse Voltage	40	30	20	V
V_{RWM}	Working Peak Reverse Voltage				
$V_{R(RMS)}$	RMS Reverse Voltage	28	21	14	V
I_{FM}	Forward Continuous Current	350			mA
I_{FSM}	Non-repetitive Peak Forward Surge Current@ $t=8.3\text{ms}$	2			A
P_D	Power Dissipation	400			mW
$R_{\theta JA}$	Thermal Resistance from Junction to Ambient	250			$^\circ\text{C}/\text{W}$
T_j	Junction Temperature	125			$^\circ\text{C}$
T_{stg}	Storage Temperature	-55~+150			$^\circ\text{C}$

ELECTRICAL CHARACTERISTICS($T_a=25^\circ\text{C}$ unless otherwise specified)

Parameter	Symbol	Test conditions	Min	Typ	Max	Unit
Reverse voltage	$V_{(BR)}$	$I_R=100\mu\text{A}$ SD103AW	40			V
		SD103BW	30			
		SD103CW	20			
Reverse current	I_R	$V_R=30\text{V}$ SD103AW			5	μA
		$V_R=20\text{V}$ SD103BW				
		$V_R=10\text{V}$ SD103CW				
Forward voltage	V_F	$I_F=20\text{mA}$			0.37	V
		$I_F=200\text{mA}$			0.6	
Total capacitance	C_{tot}	$V_R=0\text{V}, f=1\text{MHz}$		50		pF
Reverse recovery time	t_{rr}	$I_F=I_R=200\text{mA}, I_{tr}=0.1\times I_R, R_L=100\Omega$		10		ns

Forward Characteristics

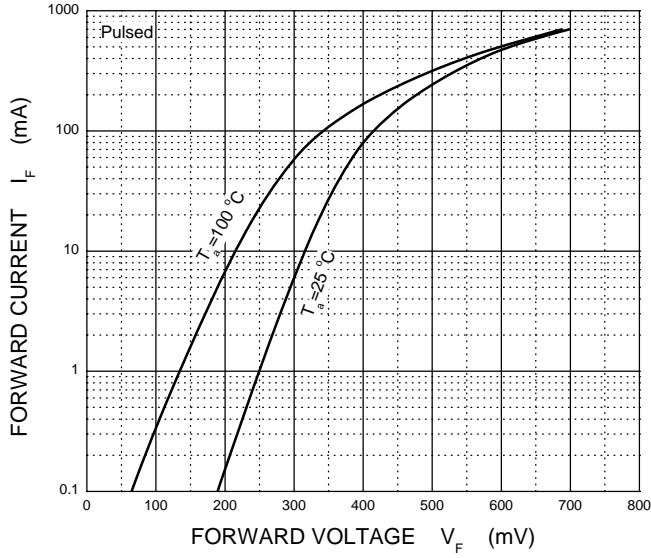

Reverse Characteristics

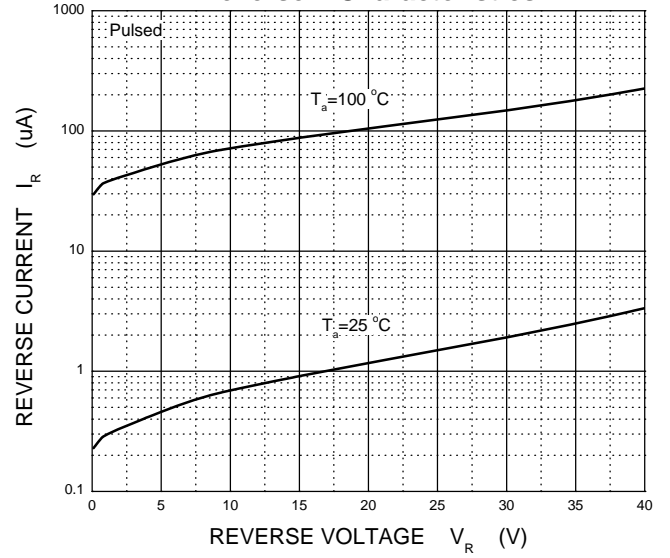

Capacitance Characteristics

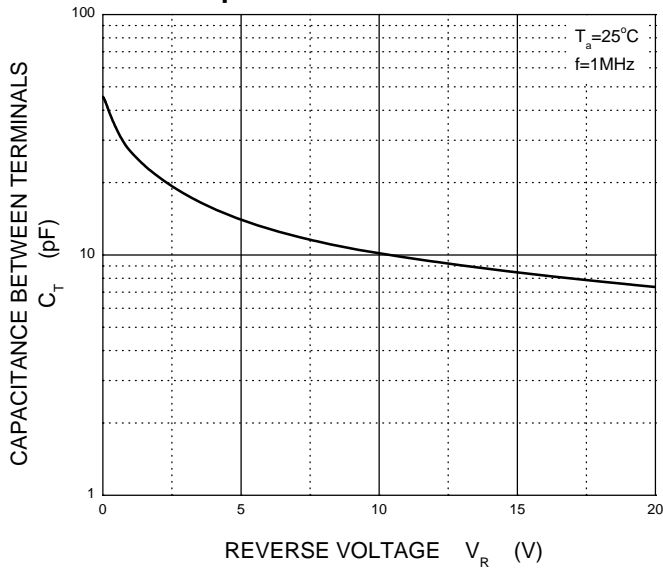

Power Derating Curve

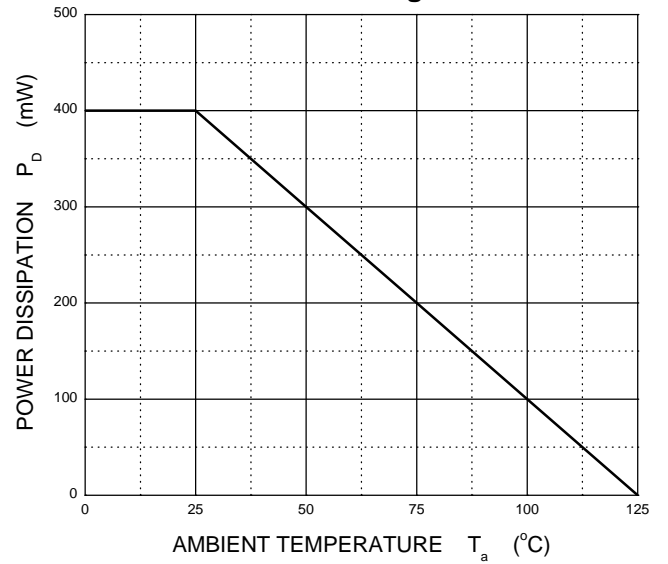

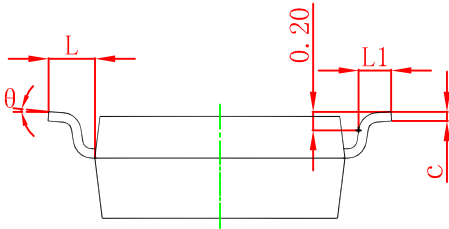
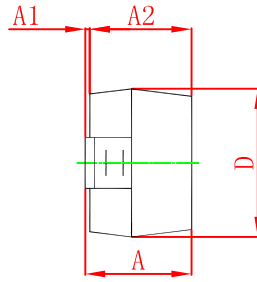
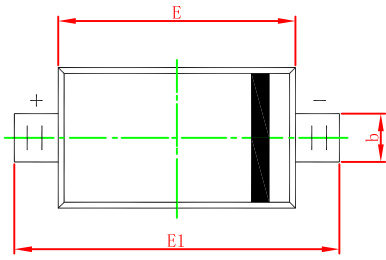

Symbol	Dimensions In Millimeters		Dimensions In Inches	
	Min	Max	Min	Max
A	1.050	1.250	0.041	0.049
A1	0.000	0.100	0.000	0.004
A2	1.050	1.150	0.041	0.045
b	0.450	0.650	0.018	0.026
c	0.080	0.150	0.003	0.006
D	1.500	1.700	0.059	0.067
E	2.600	2.800	0.102	0.110
E1	3.550	3.850	0.140	0.152
L	0.500 REF		0.020 REF	
L1	0.250	0.450	0.010	0.018
θ	0°	8°	0°	8°

SOD-123 Suggested Pad Layout

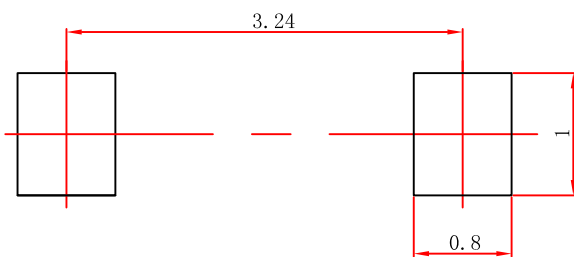

- Note:**
1. Controlling dimension: in millimeters.
 2. General tolerance: $\pm 0.05\text{mm}$.
 3. The pad layout is for reference purposes only.

SOD-123 Embossed Carrier Tape

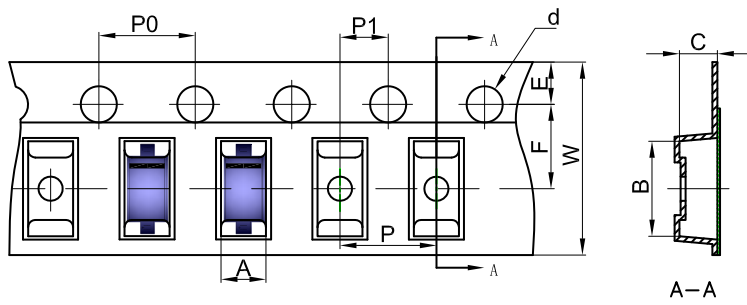

Packaging Description:
 SOD-123 parts are shipped in tape. The carrier tape is made from a dissipative (carbon filled) polycarbonate resin. The cover tape is a multilayer film (Heat Activated Adhesive in nature) primarily composed of polyester film, adhesive layer, sealant, and anti-static sprayed agent. These reeled parts in standard option are shipped with 3,000 units per 7" or 17.8cm diameter reel. The reels are clear in color and is made of polystyrene plastic (anti-static coated).

Dimensions are in millimeter											
Pkg type	A	B	C	d	E	F	P0	P	P1	W	
SOD-123	1.85	3.95	1.57	Ø1.55	1.75	3.50	4.00	4.00	2.00	8.00	

SOD-123 Tape Leader and Trailer

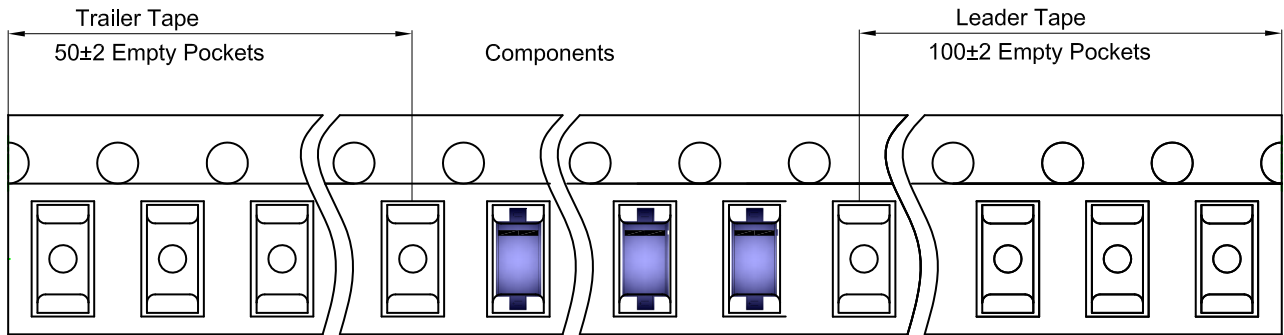

SOD-123 Reel

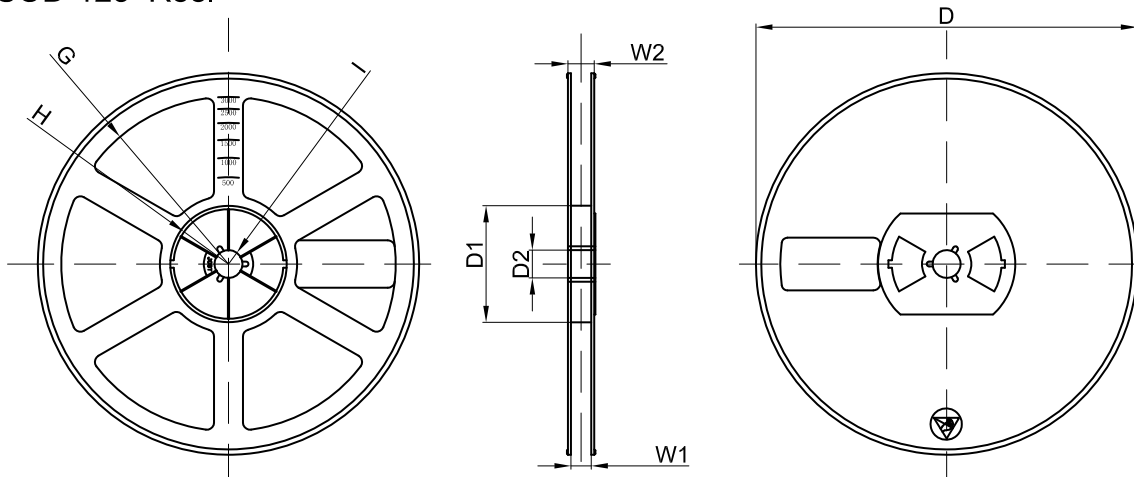

Dimensions are in millimeter								
Reel Option	D	D1	D2	G	H	I	W1	W2
7" Dia	Ø178.00	54.40	13.00	R78.00	R25.60	R6.50	9.50	12.30

REEL	Reel Size	Box	Box Size(mm)	Carton	Carton Size(mm)	G.W.(kg)
3000 pcs	7 inch	45 000 pcs	203×203×195	180 000 pcs	438×438×220	