

## Features

- Low Forward Voltage Drop
- Fast Switching

## PINNING

PIN	DESCRIPTION
1	Cathode
2	Anode

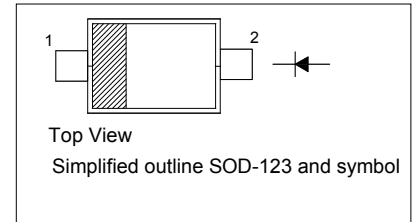

## Absolute Maximum Ratings ( $T_a = 25\text{ }^\circ\text{C}$ )

Parameter	Symbol	Value	Unit
Repetitive Peak Reverse Voltage	$V_{RRM}$	30	V
Reverse Voltage	$V_R$	30	V
Forward Continuous Current	$I_{FM}$	200	mA
Repetitive Peak Forward Current at $t < 1\text{ s}$	$I_{FRM}$	500	mA
Non-repetitive Peak Forward Surge Current at $t < 10\text{ ms}$	$I_{FSM}$	2	A
Power Dissipation	$P_{tot}$	200	mW
Thermal Resistance Junction to Ambient	$R_{\theta JA}$	500	$^\circ\text{C/W}$
Operating and Storage Temperature Range	$T_J, T_{Stg}$	- 55 to + 125	$^\circ\text{C}$

## Characteristics at $T_a = 25\text{ }^\circ\text{C}$

Parameter	Symbol	Min.	Max.	Unit
Reverse Breakdown Voltage at $I_R = 100\text{ }\mu\text{A}$	$V_{(BR)R}$	30	-	V
Reverse Current at $V_R = 25\text{ V}$	$I_R$	-	500	nA
Forward Voltage at $I_F = 200\text{ mA}$	$V_F$	-	1	V
at $I_F = 10\text{ mA}$		-	0.4	V
at $I_F = 50\text{ mA}$		-	0.65	V
at $I_F = 2\text{ mA}$		0.26	0.33	V
at $I_F = 15\text{ mA}$		-	0.45	V
Total Capacitance at $V_R = 1\text{ V}, f = 1\text{ MHz}$	$C_T$	-	10	pF
Reverse Recovery Time at $I_F = I_R = 10\text{ mA}, I_{rr} = 0.1 \times I_R, R_L = 100\text{ }\Omega$	$t_{rr}$	-	5	ns

**Typical Characteristics**

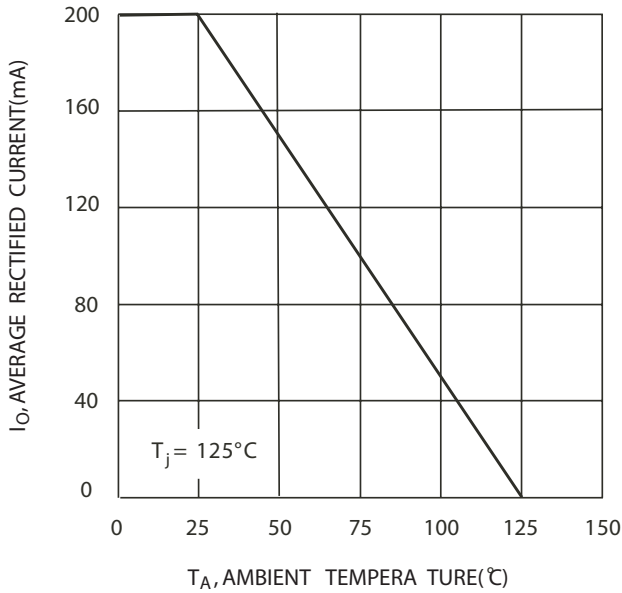

**FIG. 1 Forward Current Derating Curve**

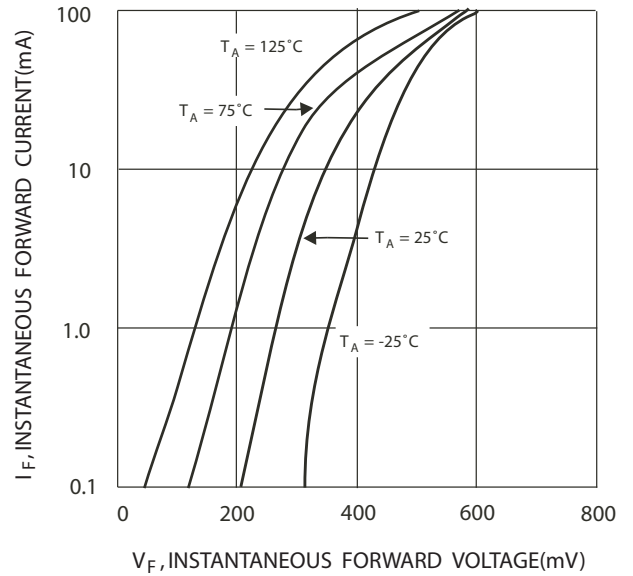

**FIG. 2 Typical Forward Characteristics**

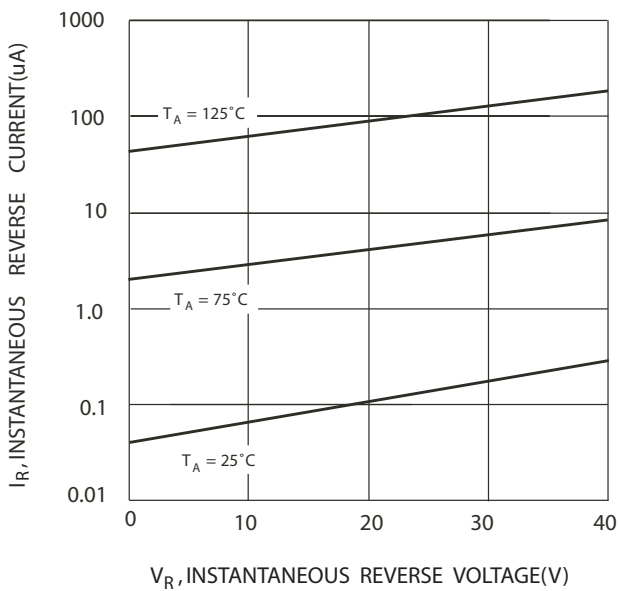

**FIG. 3 Typical Reverse Characteristics**

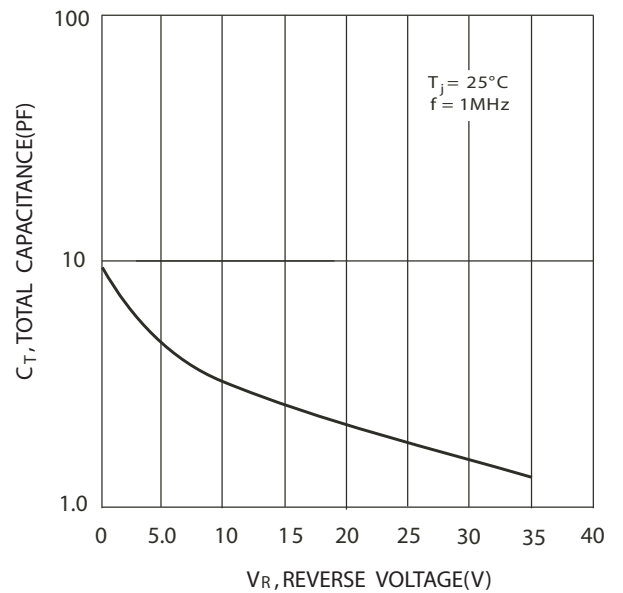
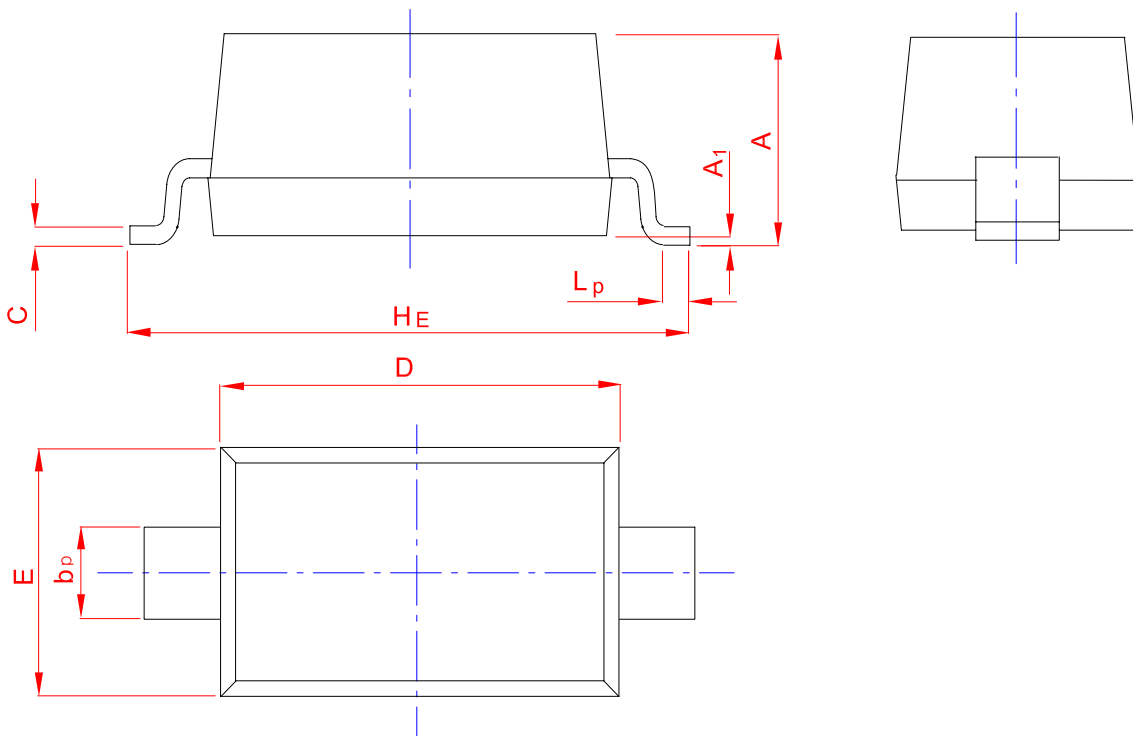
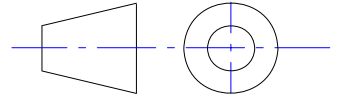

**FIG. 4 Total Capacitance vs. Reverse Voltage**

**PACKAGE OUTLINE**

Plastic surface mounted package; 2 leads

SOD-123



UNIT	A	b <sub>p</sub>	C	D	E	H <sub>E</sub>	A <sub>1</sub>	L <sub>p</sub>
mm	1.20	0.60	0.135	2.75	1.65	3.85	0.10	0.50
	0.90	0.50	0.100	2.55	1.55	3.55	0.01	0.20