

## 3-TERMINAL 0.1A POSITIVE VOLTAGE REGULATORS

### DESCRIPTION

The 78LXX series of fixed voltage monolithic integrated circuit voltage regulators are suitable for applications that required supply up to 100mA.

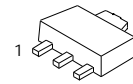

SOT89

### FEATURE

- \*Maximum output current of 100mA
- \*Output voltage of 5V,6V,8V,9V,10V,12V,15V and 24V
- \*Thermal overload protection
- \*Short circuit current limiting

### BLOCK DIAGRAM

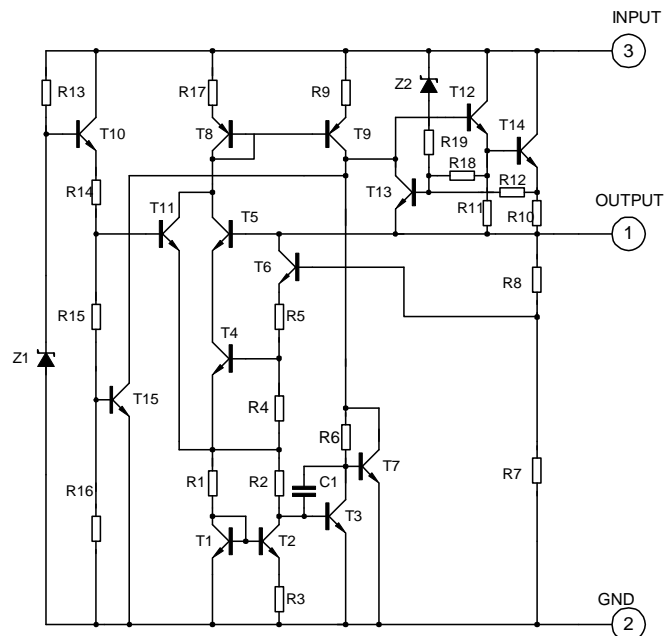

**ABSOLUTE MAXIMUM RATINGS** (Operating temperature range applies unless otherwise specified)

CHARACTERISTICS	SYMBOL	VALUE	UNITS
Input voltage(for $V_o=5,8V$ )	$V_i$	30	V
(for $V_o=12,15V$ )	$V_i$	35	V
High power dissipation	$P_d$	700	mW
Operating Junction Temperature Range	$T_{OPR}$	-20~+120	°C
Storage Temperature Range	$T_{STG}$	-55~+150	°C

**78L05 ELECTRICAL CHARACTERISTICS**

 ( $V_i=10V, I_o=40mA, 0 < T_j < 125^\circ C, C_1=0.33\mu F, C_o=0.1\mu F$ , unless otherwise specified)(Note 1)

Characteristic	Symbol	Test conditions	MIN	TYP	MAX	UNIT
Output Voltage	$V_o$	$T_j=25^\circ C$	4.8	5.0	5.2	V
		$7V \leq V_i \leq 20V, I_o=1mA \sim 40mA$	4.75		5.25	V
		$7V \leq V_i \leq V_{MAX}, I_o=1mA \sim 70mA$	4.75		5.25	V (note 2)
Output Voltage(note 3)	$V_o$	$T_j=25^\circ C$	4.9	5.0	5.1	V
		$7V \leq V_i \leq 20V, I_o=1mA \sim 40mA$	4.85		5.15	V
		$7V \leq V_i \leq V_{MAX}, I_o=1mA \sim 70mA$	4.85		5.15	V (note 2)
Load Regulation	$\Delta V_o$	$T_j=25^\circ C, I_o=1mA \sim 100mA$		11	60	mV
		$T_j=25^\circ C, I_o=1mA \sim 40mA$		5.0	30	mV
Line regulation	$\Delta V_o$	$7V \leq V_i \leq 20V, T_j=25^\circ C$		8	150	mV
		$8V \leq V_i \leq 20V, T_j=25^\circ C$		6	100	mV
Quiescent Current	$I_q$			2.0	5.5	mA
Quiescent Current Change	$\Delta I_q$	$8V \leq V_i \leq 20V$			1.5	mA
	$\Delta I_q$	$1mA \leq V_i \leq 40mA$			0.1	mA
Output Noise Voltage	$V_N$	$10Hz \leq f \leq 100kHz$		40		$\mu V$
Temperature coefficient of $V_o$	$\Delta V_o / \Delta T$	$I_o=5mA$		0.65		$mV/^\circ C$
Ripple Rejection	RR	$8V \leq V_i \leq 20V, f=120Hz, T_j=25^\circ C$	40	49		dB
Dropout Voltage	$V_d$	$T_j=25^\circ C$		1.7		V

**78L06 ELECTRICAL CHARACTERISTICS**

(VI=12V, Io=40mA, 0&lt;Tj&lt;125°C, C1=0.33μF, Co=0.1μF, unless otherwise specified)(Note 1)

Characteristic	Symbol	Test conditions	MIN	TYP	MAX	UNIT
Output Voltage	Vo	Tj=25°C	5.75	6.0	6.25	V
		8.5V≤Vi≤20V, Io=1mA~40mA	5.7		6.3	V
		8.5V≤Vi≤VMAX, Io=1mA~70mA	5.7		6.3	V (note 2)
Output Voltage(note 3)	Vo	Tj=25°C	5.88	6.0	6.12	V
		8.5V≤Vi≤20V, Io=1mA~40mA	5.82		6.18	V
		8.5V≤Vi≤VMAX, Io=1mA~70mA	5.82		6.18	V (note 2)
Load Regulation	ΔVo	Tj=25°C, Io=1mA~100mA		12.8	80	mV
		Tj=25°C, Io=1mA~70mA		5.8	40	mV
Line regulation	ΔVo	8.5V≤Vi≤20V, Tj=25°C		64	175	mV
		9V≤Vi≤20V, Tj=25°C		54	125	mV
Quiescent Current	Iq			2.0	5.5	mA
Quiescent Current Change	ΔIq	9V≤Vi≤20V			1.5	mA
	ΔIq	1mA≤Vi≤40mA			0.1	mA
Output Noise Voltage	VN	10Hz≤f≤100kHz		49		μV
Temperature coefficient of Vo	ΔVo/ΔT	Io=5mA		0.75		mV/°C
Ripple Rejection	RR	10V≤Vi≤20V, f=120Hz, Tj=25°C	38	46		dB
Dropout Voltage	Vd	Tj=25°C		1.7		V

**78L08 ELECTRICAL CHARACTERISTICS**

 (VI=14V, I<sub>o</sub>=40mA, 0<T<sub>j</sub><125°C, C1=0.33μF, Co=0.1μF, unless otherwise specified)(Note 1)

Characteristic	Symbol	Test conditions	MIN	TYP	MAX	UNIT
Output Voltage	V <sub>o</sub>	T <sub>j</sub> =25°C	7.7	8.0	8.3	V
		10.5V≤V <sub>i</sub> ≤23V, I <sub>o</sub> =1mA~40mA	7.6		8.4	V
		10.5V≤V <sub>i</sub> ≤V <sub>MAX</sub> , I <sub>o</sub> =1mA~70mA	7.6		8.4	V (note 2)
Output Voltage(note 3)	V <sub>o</sub>	T <sub>j</sub> =25°C	7.84	8.0	8.16	V
		10.5V≤V <sub>i</sub> ≤23V, I <sub>o</sub> =1mA~40mA	7.76		8.24	V
		10.5V≤V <sub>i</sub> ≤V <sub>MAX</sub> , I <sub>o</sub> =1mA~70mA	7.76		8.24	V (note 2)
Load Regulation	ΔV <sub>o</sub>	T <sub>j</sub> =25°C, I <sub>o</sub> =1mA~100mA		15	80	mV
		T <sub>j</sub> =25°C, I <sub>o</sub> =1mA~70mA		8.0	40	mV
Line regulation	ΔV <sub>o</sub>	10.5V≤V <sub>i</sub> ≤23V, T <sub>j</sub> =25°C		10	175	mV
		11V≤V <sub>i</sub> ≤23V, T <sub>j</sub> =25°C		8	125	mV
Quiescent Current	I <sub>q</sub>			2.0	5.5	mA
Quiescent Current Change	ΔI <sub>q</sub>	11V≤V <sub>i</sub> ≤23V			1.5	mA
	ΔI <sub>q</sub>	1mA≤V <sub>i</sub> ≤40mA			0.1	mA
Output Noise Voltage	V <sub>N</sub>	10Hz≤f≤100kHz		49		μV
Temperature coefficient of V <sub>o</sub>	ΔV <sub>o</sub> /ΔT	I <sub>o</sub> =5mA		0.75		mV/°C
Ripple Rejection	RR	11V≤V <sub>i</sub> ≤23V, f=120Hz, T <sub>j</sub> =25°C	36	45		dB
Dropout Voltage	V <sub>d</sub>	T <sub>j</sub> =25°C		1.7		V



**78L09 ELECTRICAL CHARACTERISTICS**

(VI=15V, Io=40mA, 0&lt;Tj&lt;125°C, C1=0.33μF, Co=0.1μF, unless otherwise specified)(Note 1)

Characteristic	Symbol	Test conditions	MIN	TYP	MAX	UNIT
Output Voltage	Vo	Tj=25°C	8.64	9.0	9.36	V
		11.5V≤Vi≤24V, Io=1mA~40mA	8.55		9.45	V
		11.5V≤Vi≤VMAX, Io=1mA~70mA	8.55		9.45	V (note 2)
Output Voltage(note 3)	Vo	Tj=25°C	8.82	9.0	9.18	V
		11.5V≤Vi≤24V, Io=1mA~40mA	8.73		9.27	V
		11.5V≤Vi≤VMAX, Io=1mA~70mA	8.73		9.27	V (note 2)
Load Regulation	ΔVo	Tj=25°C, Io=1mA~100mA		20	90	mV
		Tj=25°C, Io=1mA~40mA		10	45	mV
Line regulation	ΔVo	11.5V≤Vi≤24V, Tj=25°C		90	200	mV
		13V≤Vi≤24V, Tj=25°C		100	150	mV
Quiescent Current	Iq			2.0	5.5	mA
Quiescent Current Change	ΔIq	13V≤Vi≤24V			1.5	mA
	ΔIq	1mA≤Vi≤40mA			0.1	mA
Output Noise Voltage	VN	10Hz≤f≤100kHz		49		μV
Temperature coefficient of Vo	ΔVo/ΔT	Io=5mA		0.75		mV/°C
Ripple Rejection	RR	12V≤Vi≤23V, f=120Hz, Tj=25°C	36	44		dB
Dropout Voltage	Vd	Tj=25°C		1.7		V

## 78L12 ELECTRICAL CHARACTERISTICS

( $V_I=19V, I_O=40mA, 0 < T_j < 125^\circ C, C_1=0.33\mu F, C_o=0.1\mu F$ , unless otherwise specified)(Note 1)

Characteristic	Symbol	Test conditions	MIN	TYP	MAX	UNIT
Output Voltage	Vo	T <sub>j</sub> =25°C	11.5	12	12.6	V
		14.5V ≤ V <sub>I</sub> ≤ 27V, I <sub>O</sub> =1mA~40mA	11.4		12.6	V
		14.5V ≤ V <sub>I</sub> ≤ V <sub>MAX</sub> , I <sub>O</sub> =1mA~70mA	11.4		12.6	V (note 2)
Output Voltage(note 3)	Vo	T <sub>j</sub> =25°C	11.76	12.0	12.24	V
		14.5V ≤ V <sub>I</sub> ≤ 27V, I <sub>O</sub> =1mA~40mA	11.64		12.36	V
		14.5V ≤ V <sub>I</sub> ≤ V <sub>MAX</sub> , I <sub>O</sub> =1mA~70mA	11.64		12.36	V (note 2)
Load Regulation	ΔVo	T <sub>j</sub> =25°C, I <sub>O</sub> =1mA~100mA		25	150	mV
		T <sub>j</sub> =25°C, I <sub>O</sub> =1mA~40mA		12	75	mV
Line regulation	ΔVo	14.5V ≤ V <sub>I</sub> ≤ 27V, T <sub>j</sub> =25°C		25	300	mV
		16V ≤ V <sub>I</sub> ≤ 27V, T <sub>j</sub> =25°C		20	250	mV
Quiescent Current	I <sub>q</sub>			2.0	5.5	mA
Quiescent Current Change	ΔI <sub>q</sub>	16V ≤ V <sub>I</sub> ≤ 27V			1.5	mA
	ΔI <sub>q</sub>	1mA ≤ I <sub>O</sub> ≤ 40mA			0.1	mA
Output Noise Voltage	V <sub>N</sub>	10Hz ≤ f ≤ 100kHz		80		μV
Temperature coefficient of Vo	ΔVo/ΔT	I <sub>O</sub> =5mA		1.0		mV/°C
Ripple Rejection	RR	15V ≤ V <sub>I</sub> ≤ 25V, f=120Hz, T <sub>j</sub> =25°C	36	42		dB
Dropout Voltage	V <sub>d</sub>	T <sub>j</sub> =25°C		1.7		V

**78L15 ELECTRICAL CHARACTERISTICS**

(VI=23V, Io=40mA, 0&lt;Tj&lt;125°C, C1=0.33μF, Co=0.1μF, unless otherwise specified)(Note 1)

Characteristic	Symbol	Test conditions	MIN	TYP	MAX	UNIT
Output Voltage	Vo	Tj=25°C	14.4	15	15.6	V
		17.5V≤Vi≤30V, Io=1mA~40mA	14.25		15.75	V
		17.5V≤Vi≤VMAX, Io=1mA~70mA	14.25		15.75	V (note 2)
Output Voltage(note 3)	Vo	Tj=25°C	14.7	15.0	15.3	V
		17.5V≤Vi≤30V, Io=1mA~40mA	14.55		15.45	V
		17.5V≤Vi≤VMAX, Io=1mA~70mA	14.55		15.45	V (note 2)
Load Regulation	ΔVo	Tj=25°C, Io=1mA~100mA		20	150	mV
		Tj=25°C, Io=1mA~70mA		25	150	mV
Line regulation	ΔVo	17.5V≤Vi≤30V, Tj=25°C		25	150	mV
		20V≤Vi≤30V, Tj=25°C		15	75	mV
Quiescent Current	Iq			2.2	6.0	mA
Quiescent Current Change	ΔIq	20V≤Vi≤30V			1.5	mA
	ΔIq	1mA≤Vi≤40mA			0.1	mA
Output Noise Voltage	VN	10Hz≤f≤100kHz		90		μV
Temperature coefficient of Vo	ΔVo/ΔT	Io=5mA		1.3		mV/°C
Ripple Rejection	RR	18.5V≤Vi≤28.5V, f=120Hz, Tj=25°C	33	39		dB
Dropout Voltage	Vd	Tj=25°C		1.7		V

**78L18 ELECTRICAL CHARACTERISTICS**

(VI=27V, IO=40mA, 0&lt;Tj&lt;125°C, C1=0.33μF, Co=0.1μF, unless otherwise specified)(Note 1)

Characteristic	Symbol	Test conditions	MIN	TYP	MAX	UNIT
Output Voltage	Vo	Tj=25°C	17.3	18	18.7	V
		21V≤Vi≤33V, IO=1mA~40mA	17.1		18.9	V
		21V≤Vi≤VMAX, IO=1mA~70mA	17.1		18.9	V (note 2)
Output Voltage(note 3)	Vo	Tj=25°C	17.64	18.0	18.36	V
		21V≤Vi≤33V, IO=1mA~40mA	17.46		18.54	V
		21V≤Vi≤VMAX, IO=1mA~70mA	17.46		18.54	V (note 2)
Load Regulation	ΔVo	Tj=25°C, IO=1mA~100mA		30	170	mV
		Tj=25°C, IO=1mA~40mA		15	85	mV
Line regulation	ΔVo	21V≤Vi≤33V, Tj=25°C		145	300	mV
		22V≤Vi≤33V, Tj=25°C		135	250	mV
Quiescent Current	Iq			2.2	6.0	mA
Quiescent Current Change	ΔIq	21V≤Vi≤33V			1.5	mA
	ΔIq	1mA≤Vi≤40mA			0.1	mA
Output Noise Voltage	VN	10Hz≤f≤100kHz		150		μV
Temperature coefficient of Vo	ΔVo/ΔT	IO=5mA		1.8		mV/°C
Ripple Rejection	RR	23V≤Vi≤33V, f=120Hz, Tj=25°C	32	38		dB
Dropout Voltage	Vd	Tj=250°C		1.7		V

## 78L24 ELECTRICAL CHARACTERISTICS

( $V_I=33V, I_o=40mA, 0 < T_j < 125^\circ C, C_1=0.33\mu F, C_o=0.1\mu F$ , unless otherwise specified)(Note 1)

Characteristic	Symbol	Test conditions	MIN	TYP	MAX	UNIT
Output Voltage	Vo	T <sub>j</sub> =25°C	23	24	25	V
		27V ≤ V <sub>I</sub> ≤ 38V, I <sub>o</sub> =1mA~40mA	22.8		25.2	V
		27V ≤ V <sub>I</sub> ≤ V <sub>MAX</sub> , I <sub>o</sub> =1mA~70mA	22.8		25.2	V (note 2)
Output Voltage(note 3)	Vo	T <sub>j</sub> =25°C	23.5	24	24.5	V
		27V ≤ V <sub>I</sub> ≤ 38V, I <sub>o</sub> =1mA~40mA	23.25		24.75	V
		27V ≤ V <sub>I</sub> ≤ V <sub>MAX</sub> , I <sub>o</sub> =1mA~70mA	23.25		24.75	V (note 2)
Load Regulation	ΔVo	T <sub>j</sub> =25°C, I <sub>o</sub> =1mA~100mA		40	200	mV
		T <sub>j</sub> =25°C, I <sub>o</sub> =1mA~40mA		20	100	mV
Line regulation	ΔVo	27V ≤ V <sub>I</sub> ≤ 38V, T <sub>j</sub> =25°C		160	300	mV
		28V ≤ V <sub>I</sub> ≤ 38V, T <sub>j</sub> =25°C		150	250	mV
Quiescent Current	I <sub>q</sub>			2.2	6.0	mA
Quiescent Current Change	ΔI <sub>q</sub>	27V ≤ V <sub>I</sub> ≤ 38V			1.5	mA
	ΔI <sub>q</sub>	1mA ≤ V <sub>I</sub> ≤ 40mA			0.1	mA
Output Noise Voltage	V <sub>N</sub>	10Hz ≤ f ≤ 100kHz		200		μV
Temperature coefficient of Vo	ΔVo/ΔT	I <sub>o</sub> =5mA		2.0		mV/°C
Ripple Rejection	RR	27V ≤ V <sub>I</sub> ≤ 38V, f=120Hz, T <sub>j</sub> =25°C	30	37		dB
Dropout Voltage	V <sub>d</sub>	T <sub>j</sub> =25°C		1.7		V

Note 1: The Maximum steady state usable output current and input voltage are very dependent on the heating sinking and/or lead temperature length of the package. The data above represent pulse test conditions with junction temperatures as indicated at the initiation of test.

Note 2: Power dissipation < 0.75W.

Note 3: Output voltage of 78LXXA.

## TYPICAL APPLICATION

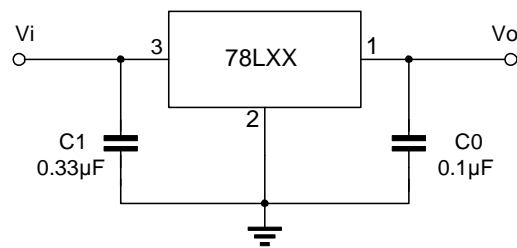

Note 1: To specify an output voltage, substitute voltage value for "XX".

Note 2: Bypass capacitors are recommended for optimum stability and transient response and should be located as close as possible to the regulators.

Fig. 1 78L05/12 Output Voltage vs Ambient Temperature

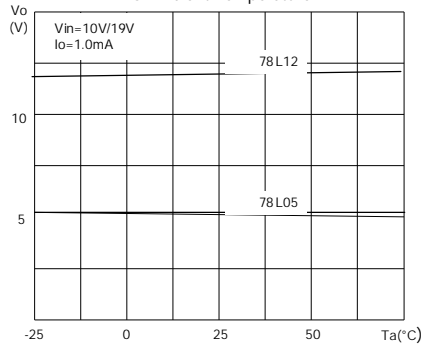

Fig 2 78L05/12 Quiescent Current vs Output Current

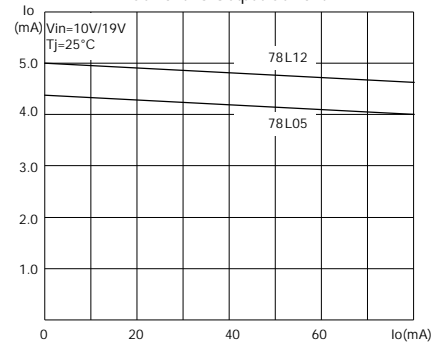

Fig.3 78L05 Quiescent Current vs Input

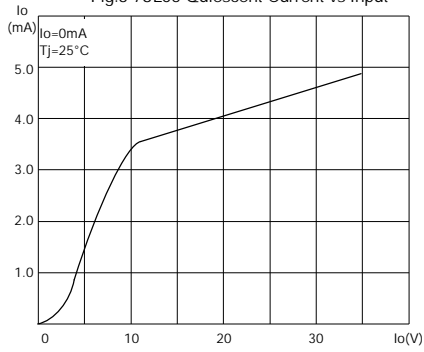

Fig.4 78L05/12/24 Thermal Shutdown

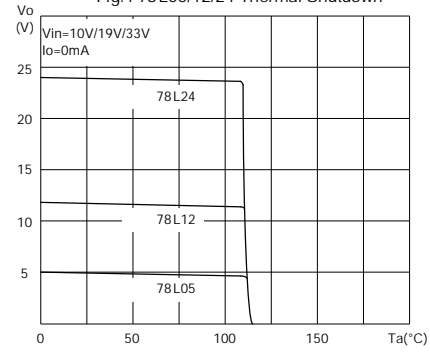

Fig.5 78L05/12/24 Output Characteristics

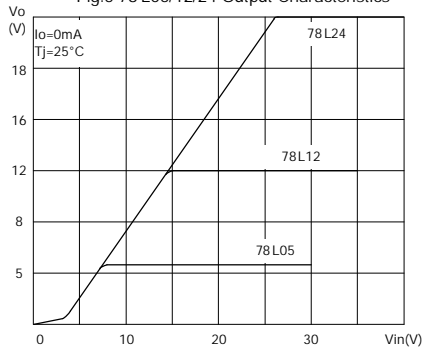
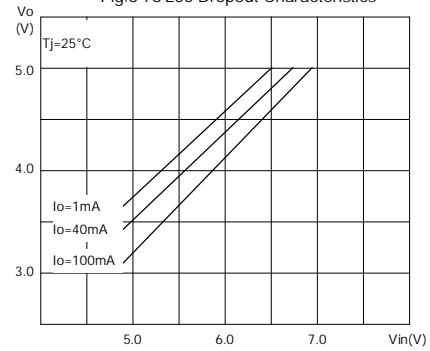

Fig.6 78L05 Dropout Characteristics



## PACKAGE OUTLINE

