



Features

- 1.2V ~ 5.5V Operating Voltage Range
- Ultra-low On-Resistance:
 - $R_{DS(ON)} = 50m\Omega$ at $V_{IN} = 5.5V$
 - $R_{DS(ON)} = 67m\Omega$ at $V_{IN} = 3.3V$
 - $R_{DS(ON)} = 110m\Omega$ at $V_{IN} = 1.8V$
 - $R_{DS(ON)} = 230m\Omega$ at $V_{IN} = 1.2V$
- Continuous Output Current up to 1.5A
- Output Auto-Discharge
- Active High Enable Control
- WLCSP4, 0.76mm × 0.76mm with 0.4mm Pitch

Applications

- Mobile Phones
- Tablets
- Digital Cameras
- GPS
- Portable Devices

Description

The LP5240 is an advanced load switch in an ultra-small package. The internal P-type MOSFET and the slew rate control make it easy to use. An output discharge path is integrated to the external components and simplify the design.

Thanks to the current optimization, LP5240 is suitable for ultra-low current consumption application to save energy. It operates over a wide input voltage range from 1.2V to 5.5V. The device contains a soft-start function to reduce the input inrush current when it is turned on.

The LP5240 is available in a 4-pin WLCSP4 package with 0.4mm pin pitch.

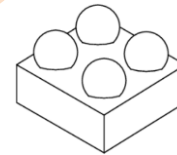

WLCSP4
0.4mm pin pitch
0.76 × 0.76 mm²

Ordering Information

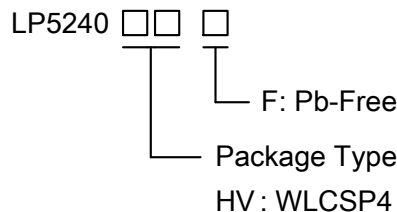

Typical Application Circuit

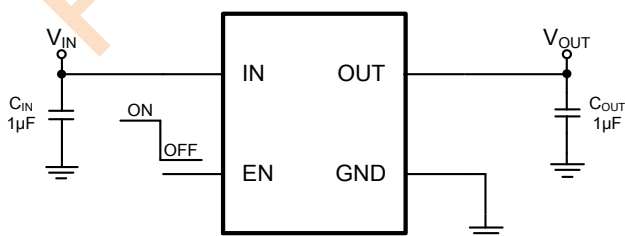

Marking Information

Device	Marking	Package	Shipping
LP5240HVF	LPS C6X	WLCSP4	3K/REEL
Marking indication: C6: Internal code, X: Production week			



Pin Configuration

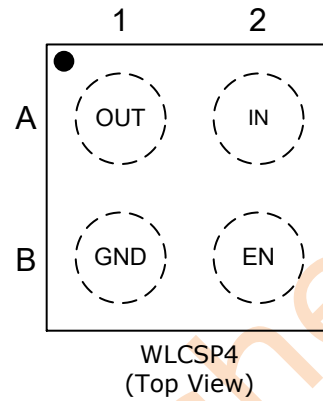
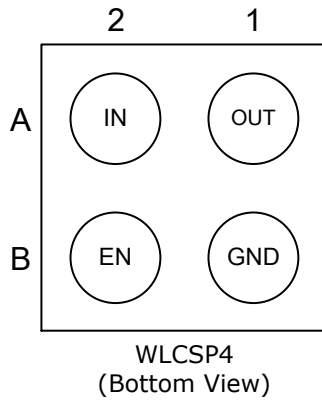

Pin Description

Pin No.	Name	Description
A1	OUT	Load switch output
A2	IN	Load switch input
B1	GND	Ground
B2	EN	Active high enable input

Functional Block Diagram

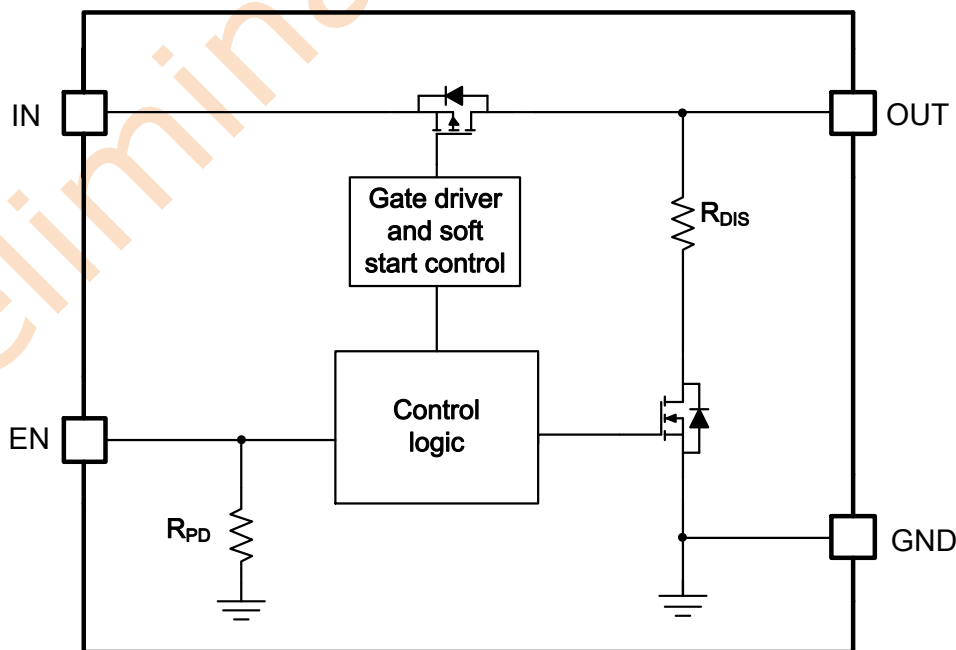



Absolute Maximum Ratings (Note 1)

- IN to GND ----- -0.3V to 8V
- EN to GND ----- -0.3V to 8V
- OUT to GND ----- -0.3V to (V_{IN}+0.3V)
- Maximum Junction Temperature (T_J) ----- 125°C
- Operating Ambient Temperature Range (T_A) ----- -40°C to 85°C
- Maximum Soldering Temperature (At leads, 10 sec) ----- 260°C

*Note 1: Stresses beyond those listed under “Absolute Maximum Ratings” may cause permanent damage to the device. These are stress ratings only, and functional operation of the device at these or any other conditions beyond those indicated in the operational sections of the specifications is not implied. Exposure to absolute maximum rating conditions for extended periods may affect device reliability.

Thermal Information

- Maximum Power Dissipation (P_D, T_A ≤ 25°C) ----- 400mW
- Thermal Resistance (θ_{JA}) (Note 2) ----- 150°C/W

*Note 2: Measured using 2S2P JEDEC standard PCB with ambient temperature < 25°C

Electro-Static Discharge and Latch-up

- HBM (Human Body Model, JEDEC JS-001) ----- 8000V
- CDM (Charged Device Model, JEDEC JS-002) ----- 1000V
- MM (Machine Model, JESD22-A115C) ----- 200V
- Latch-Up (Latch-up, JEDEC Standard JESD78E) ----- ± 200mA

Recommended Operating Conditions

Characteristics	Symbol	Conditions	Min	Max	Units
Input and power supply	V _{IN}		1.2	5.5	V
Maximum dc current	I _{OUT}			1.5	A
Maximum peak current	I _{PEAK}	Effective Duration <1ms		2	A
Ambient Temperature Range	T _A		-40	85	°C
Decoupling input capacitor	C _{IN}		0.1		μF
Decoupling output capacitor	C _{OUT}		0.1		μF



Electrical Characteristics

The parameters are measured under conditions $V_{IN} = 1.2V$ to $5.5V$, $C_{IN} = C_{OUT} = 1\mu F$, $T_A = 25^\circ C$, unless otherwise specified.

Parameter	Symbol	Test Conditions	Min	Typ.	Max	Units
On resistance	$R_{DS(ON)}$	$V_{IN}=5.5V, I_{OUT}=200mA$		50	65	m Ω
		$V_{IN}=3.3V, I_{OUT}=200mA$		67	85	m Ω
		$V_{IN}=1.8V, I_{OUT}=200mA$		110	140	m Ω
		$V_{IN}=1.2V, I_{OUT}=200mA$		230	280	m Ω
Output discharge resistance	R_{DIS}	$V_{IN}=3.3V, V_{EN}=0V$		70	110	Ω
EN pull-down resistor	R_{PD}			6.5		M Ω
EN logic high voltage	V_{IH}	$1.2V \leq V_{IN} \leq 5.5V$	0.8			V
EN logic low voltage	V_{IL}	$1.2V \leq V_{IN} \leq 5.5V$			0.4	V
Input quiescent current	I_Q	$V_{IN} = 4.2V, V_{EN} = 3V, \text{No load}$		180	240	nA
		$V_{IN} = 5.5V, V_{EN} = 3V, \text{No load}$		190	250	
Input standby current	I_{STB}	$V_{IN} = 4.2V, V_{EN} = 0V, \text{No load}$		180	240	nA
		$V_{IN} = 5.5V, V_{EN} = 0V, \text{No load}$		190	250	
Switch shutdown leakage current	I_{SD}	$V_{IN} = 4.2V, V_{EN} = 0V, V_{OUT} = 0V, T_A = -40^\circ C \text{ to } 85^\circ C$		50	580	nA
		$V_{IN} = 5.5V, V_{EN} = 0V, V_{OUT} = 0V, T_A = -40^\circ C \text{ to } 85^\circ C$		65	600	
Enable time (Note 3)	t_{EN}	$V_{IN}=3.6V, C_{OUT}=1\mu F, R_{LOAD}=25\Omega$		170		μs
		$V_{IN}=5.0V, C_{OUT}=1\mu F, R_{LOAD}=25\Omega$		220		μs
Output rising time (Note 3)	t_R	$V_{IN}=3.6V, C_{OUT}=1\mu F, R_{LOAD}=25\Omega$		140		μs
		$V_{IN}=5.0V, C_{OUT}=1\mu F, R_{LOAD}=25\Omega$		160		μs
Disable time (Note 3)	t_{DIS}	$V_{IN}=3.6V, C_{OUT}=1\mu F, R_{LOAD}=25\Omega$		4		μs
		$V_{IN}=5.0V, C_{OUT}=1\mu F, R_{LOAD}=25\Omega$		4		μs
Output falling time (Note 3)	t_F	$V_{IN}=3.6V, C_{OUT}=1\mu F, R_{LOAD}=5\Omega$		14		μs
		$V_{IN}=3.6V, C_{OUT}=1\mu F, R_{LOAD}=25\Omega$		55		μs
		$V_{IN}=3.6V, C_{OUT}=1\mu F, R_{LOAD}=100\Omega$		100		μs

*Note 3: The time period indicated by each parameter is defined as Figure 1.



Timing Diagram

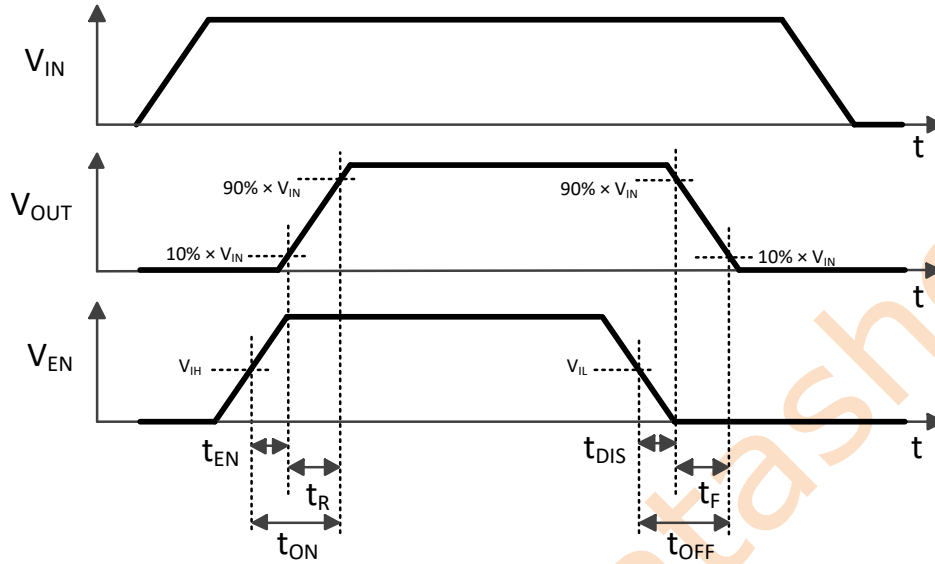

Figure 1. Timing diagram by EN pin toggled

Typical Waveforms

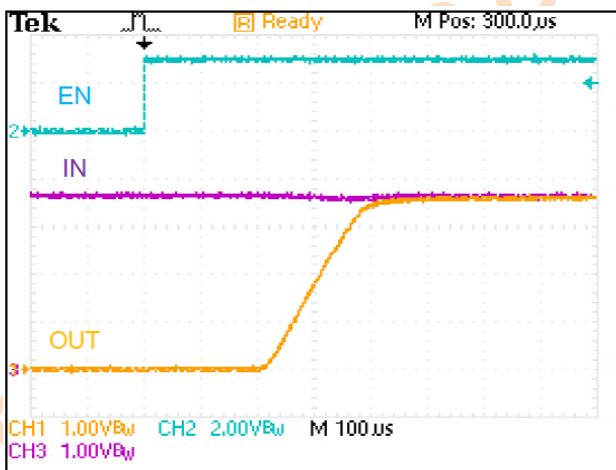

Figure 2. Turn on with EN pin
($C_{IN}=1\mu F$, $C_{OUT}=1\mu F$, $V_{IN}=3.6V$, $R_{LOAD}=25\Omega$)

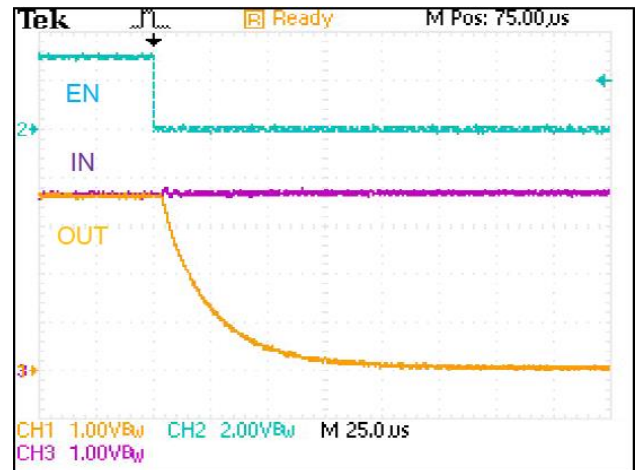

Figure 3. Turn off with EN pin
($C_{IN}=1\mu F$, $C_{OUT}=1\mu F$, $V_{IN}=3.6V$, $R_{LOAD}=25\Omega$)



Typical Characteristics

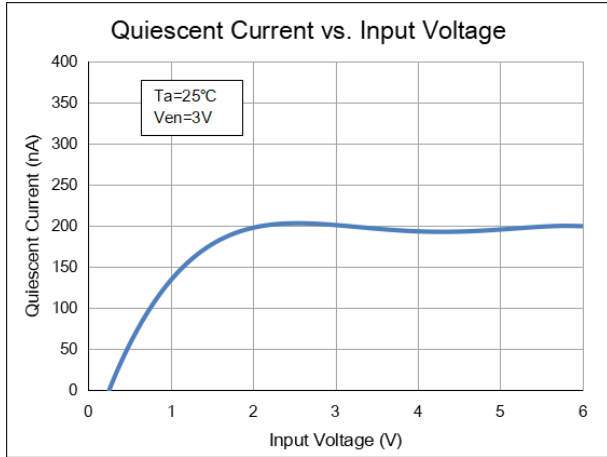

Figure 4. Quiescent Current vs Voltage
($C_{IN}=C_{OUT}=1\mu F$, $T_A=25^\circ C$)

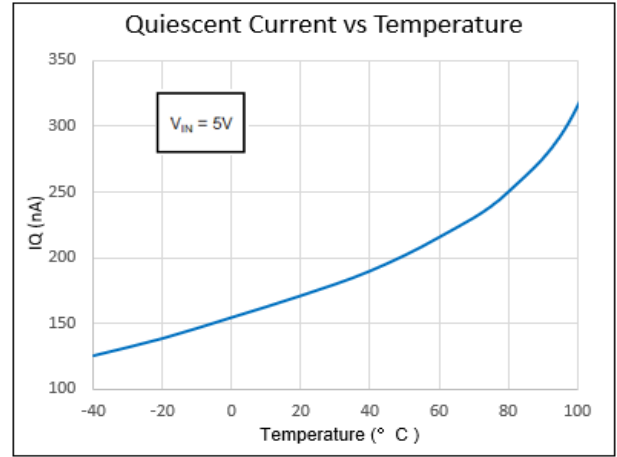

Figure 5. Quiescent Current vs Temperature
($C_{IN}=C_{OUT}=1\mu F$)

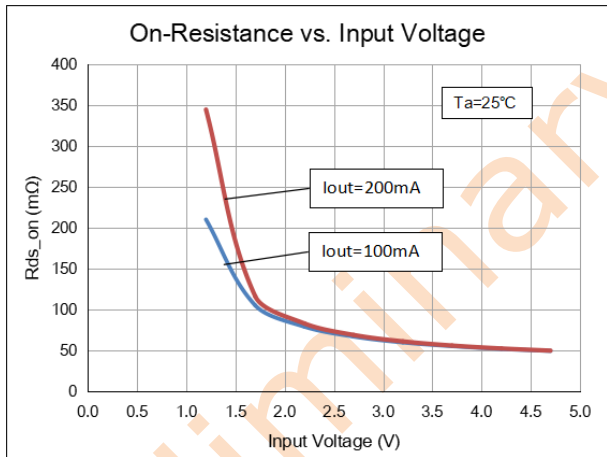

Figure 6 R_{ON} vs Voltage
($C_{IN}=C_{OUT}=1\mu F$, $T_A=25^\circ C$)

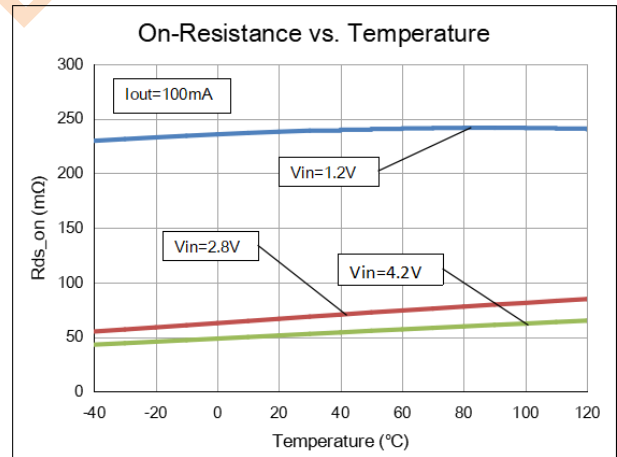

Figure 7 R_{ON} vs Temperature
($C_{IN}=C_{OUT}=1\mu F$)

Function Description

Enable Function

The LP5240 is a single channel load switch in an ultra-small WLCSP package with 1.5A current capability. The device contains a high side, low resistance P-Type MOSFET. The integrated slew rate control makes it suitable for applications that need to limit the input inrush current.

Enable Function

The EN pin is an active high Logic input pin that is compatible with 1.2V control logic. The internal pass element is turned off when EN pin is tied low.

Auto Discharge

The LP5240 has a quick discharge function. When the device is disabled, a discharge resistor is connected between OUT and GND. The resistance is 70Ω (typical).

Soft Start

The device includes a soft-start function in order to limit the input in-rush current and voltage ringing when the EN pin is pulled to a logic high.

Application Information

Capacitors consideration

External capacitors on IN and OUT are recommended in application, 0.1μF at least. Closer placement of the capacitors to the device, both IN and OUT, would be better for stability.

Power Dissipation

The internal power dissipation from the power MOSFET, when it is turned on, is the main source of junction temperature rising. In this case, the power dissipation and the junction temperature in conducting mode can be calculated as following:

$$P_D = R_{DS(ON)} \times (I_{OUT})^2$$

P_D : Power Dissipation (W)

$R_{DS(ON)}$: Power MOSFET on resistance (Ω)

I_{OUT} : Output current (A)

$$T_J = P_D \times \theta_{JA} + T_A$$

T_J : Junction temperature (°C)

θ_{JA} : Package thermal resistance (°C /W) (Note 4)

T_A : Ambient temperature (°C)

***Note 4: The calculation base on thermal resistance is only valid in Lab condition. The value of θ_{JA} could change in customer PCB environment.**



Package Dimensions

WLCSP4, 0.76mm x 0.76mm

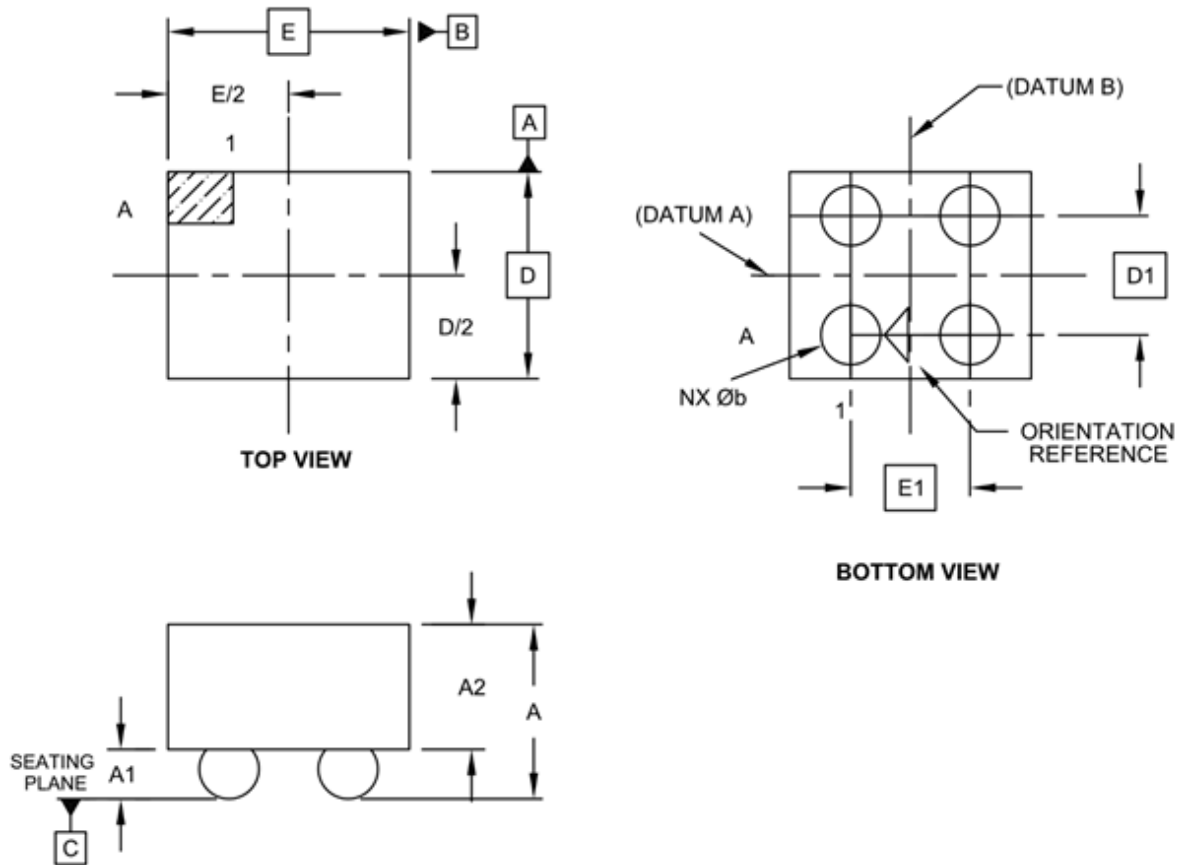

Dimension Limits	Units	MILLIMETERS		
		MIN	NOM	MAX
Number of Contacts	N		4	
Adjacent Column X-Pitch	E1	0.400 BSC		
Adjacent Row Y-Pitch	D1	0.400 BSC		
Overall Height	A	0.570	0.600	0.630
Die Height	A2	0.387	0.400	0.413
Bump Height	A1	0.180	0.200	0.220
Overall Length	E	0.735	0.755	0.775
Overall Width	D	0.735	0.755	0.775
Ball Diameter	b	0.240	0.260	0.280