

TSG001*****

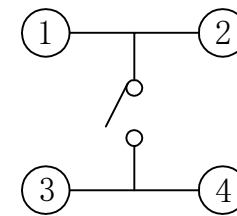

电路图
CIRCUIT DIAGRAM

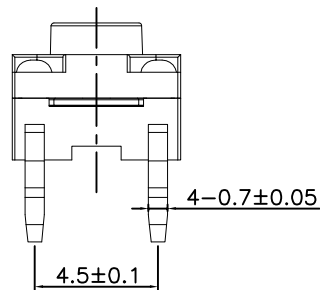
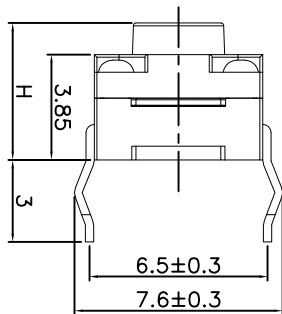
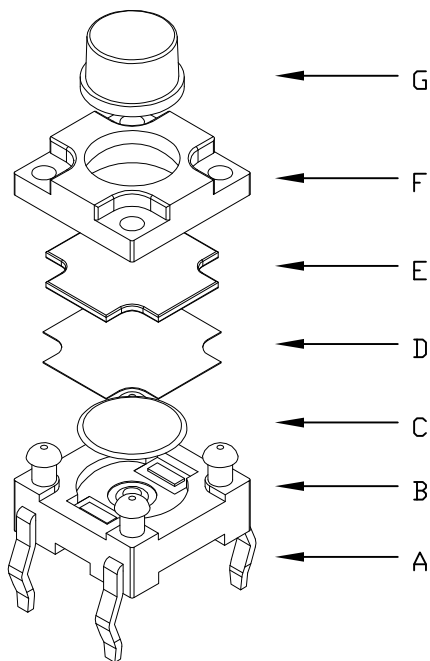
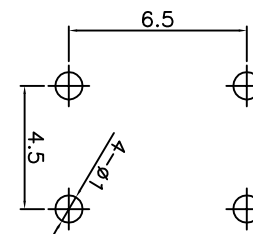
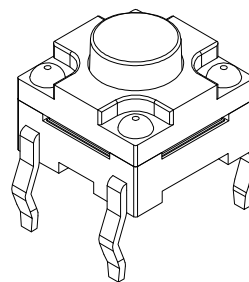
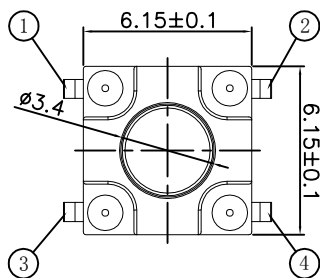

PCB. 焊接图
PCB. WELDING DRAWING

主要技术参数、性能
The Main Thchnology Performance

额定电流、电压 Rate voltage.current	50mA DC12V
接触电阻 Contact resistance	≤100mΩ
按力 Operating force	±50gf
行程 Travel	0.30±0.10mm
绝缘电阻 Insulated resistance	≥100MΩ
介电强度 Dielectric strength	≥250VAC/1min

T S G 0 0 1

寿命:
A: ≥50000次
B: ≥100000次
C: ≥300000次

高度H:
043: 4.3H
045: 4.5H
048: 4.8H
050: 5.0H
055: 5.5H
...
110: 11.0H

力度:
18: 180g
26: 260g

包装方式:
A: 散件
B: 冷封编带
C: 热封编带

项目 ITEM	名称 DESCRIPTION	材质 MATERIAL	数量 QTY	表面处理/颜色 FINSH/COLOR
G	按钮	PPA	1	黑色
F	盖板	PPA	1	黑色
E	防尘胶	硅胶	1	黑色
D	防水层	聚酰亚胺	1	橙黄色
C	弹片	不锈钢	1	镀银
B	本体	PPA	1	黑色
A	卡件	黄铜	1	镀银

标记 SING	处数 FREQUENCY	更改文件号 REVISION	签名 APPROVED	日期 DATE	比例 SCALE	1:1	一般公差 GENERAL TOLERANCE	
设计	DESIGN	朱元隆	2021.06.01	单位 UNIT	mm	≥0~2<	±0.10	
审核	CHECKED	赵晓峰	2021.06.01	重量 WEIGHT		≥2~5<	±0.25	
批准	APPROVED	陈乐峰	2021.06.01			≥5	±0.30	
						角度 ANGLE	±0.5°	

名称/NAME:	轻触开关 TACTILE SWITCH
型号/MODEL:	TSG001*****
BZCN 浙江博众电气有限公司 ZHEJIANG BOZHONG ELECTRONIC CO., LTD.	