

## FEATURES

- Low noise and high gain.  
 $NF=1.1\text{dB TYP.}, G_a=11\text{dB TYP.}$   
 $@V_{CE}=10\text{V}, I_C=7\text{mA}, f=1.0\text{GHz}$
- High power gain.  $MAG=13\text{dB TYP.}$   
 $@V_{CE}=10\text{V}, I_C=20\text{mA}, f=1.0\text{GHz.}$

## APPLICATIONS

- Designed for low noise amplifier at VHF, UHF and CATV band.

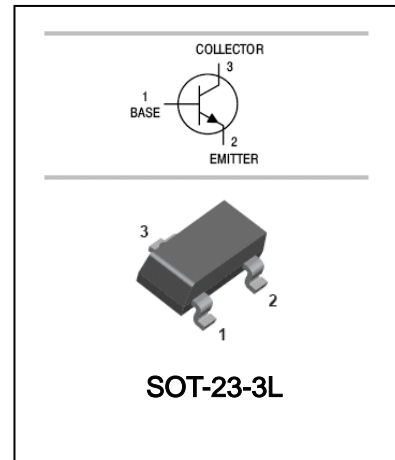

## ORDERING INFORMATION

Type No.	Marking	Package Code
2SC3356-R25	R25	SOT-23-3L

## MAXIMUM RATING @ $T_a=25^\circ\text{C}$ unless otherwise specified

Symbol	Parameter	Value	Units
$V_{CBO}$	Collector-Base Voltage	20	V
$V_{CEO}$	Collector-Emitter Voltage	12	V
$V_{EBO}$	Emitter-Base Voltage	3	V
$I_C$	Collector Current -Continuous	100	mA
$P_C$	Collector Dissipation	200	mW
$T_j, T_{stg}$	Junction and Storage Temperature	-65 to +150	$^\circ\text{C}$

## ELECTRICAL CHARACTERISTICS @ Ta=25°C unless otherwise specified

Parameter	Symbol	Test conditions	MIN	TYP	MAX	UNIT
Collector-base breakdown voltage	$V_{(BR)CBO}$	$I_C=10\mu A, I_E=0$	20			V
Collector-emitter breakdown voltage	$V_{(BR)CEO}$	$I_C=1mA, I_B=0$	12			V
Emitter-base breakdown voltage	$V_{(BR)EBO}$	$I_E=10\mu A, I_C=0$	3			V
Collector cut-off current	$I_{CBO}$	$V_{CB}=10V, I_E=0$			1	$\mu A$
Emitter cut-off current	$I_{EBO}$	$V_{EB}=1V, I_C=0$			1	$\mu A$
DC current gain	$h_{FE}$	$V_{CE}=10V, I_C=20mA$	50	120	300	
Transition frequency	$f_T$	$V_{CE}=10V, I_C=20mA$		7		GHz
Insertion power gain	$ S_{21e} ^2$	$V_{CE}=10V, I_C=20mA, f=1GHz$		11.5		dB
Feed-back capacitance	$C_{re}$	$V_{CB}=10V, I_E=0, f=1MHz$		0.55	1.0	pF
Noise Figure	NF	$V_{CE}=10V, I_C=7mA, f=1GHz$		1.1	2.0	dB

 CLASSIFICATION OF  $h_{FE}$ 

Range	125-250
Marking	R25

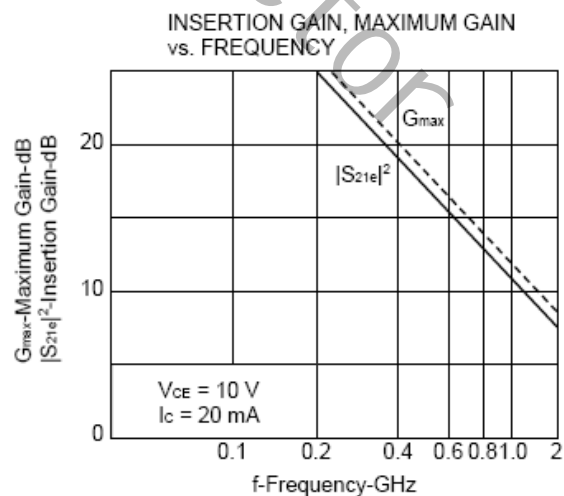
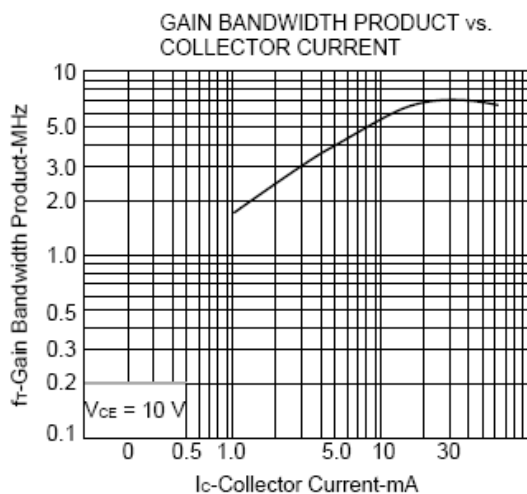
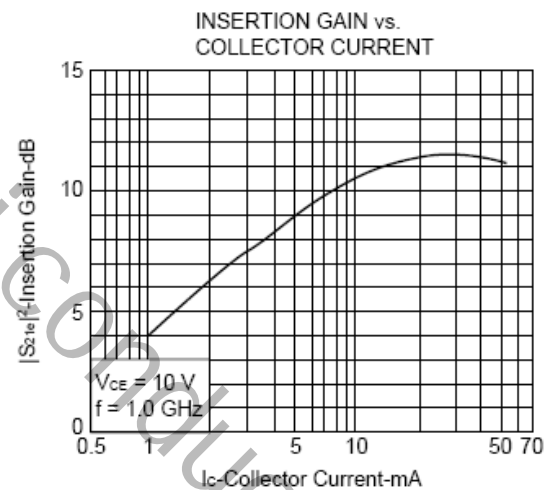
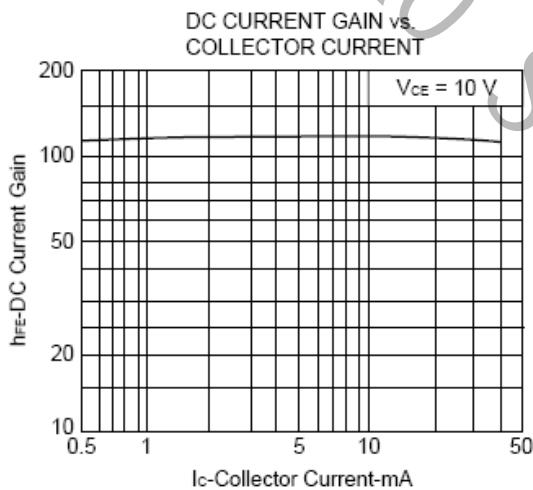
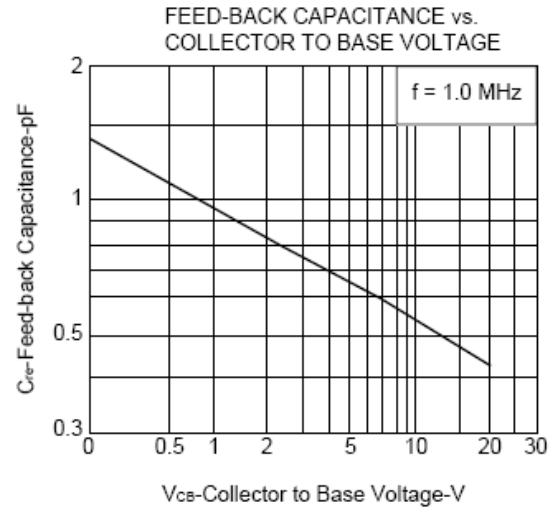
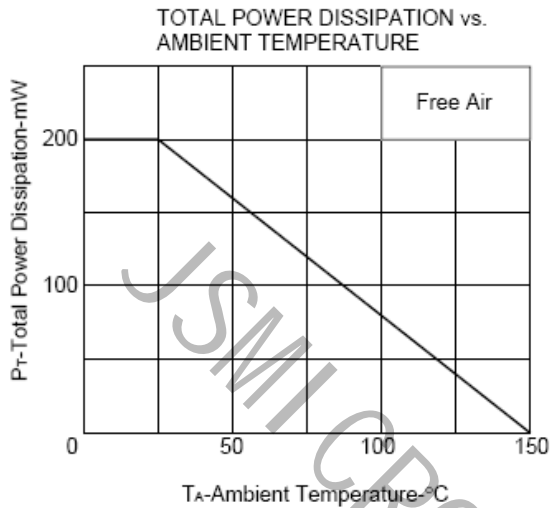
**TYPICAL CHARACTERISTICS @  $T_a=25^\circ\text{C}$  unless otherwise specified**

### PACKAGE OUTLINE

Plastic surface mounted package

SOT-23-3L

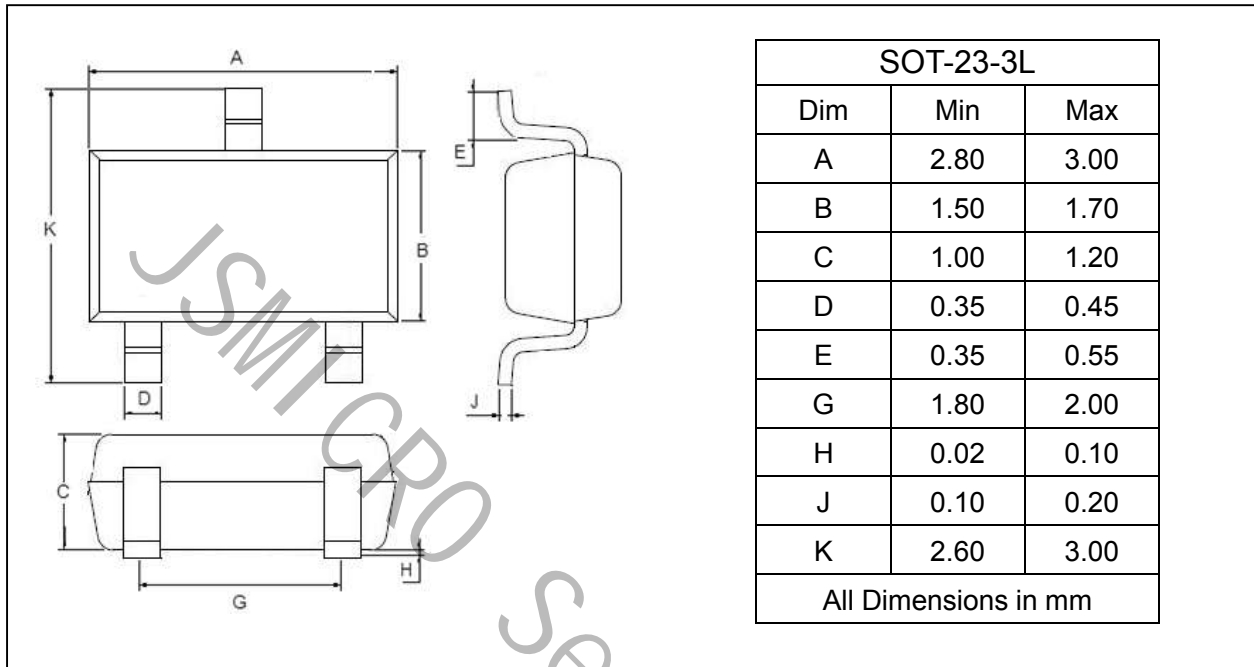

### SOLDERING FOOTPRINT

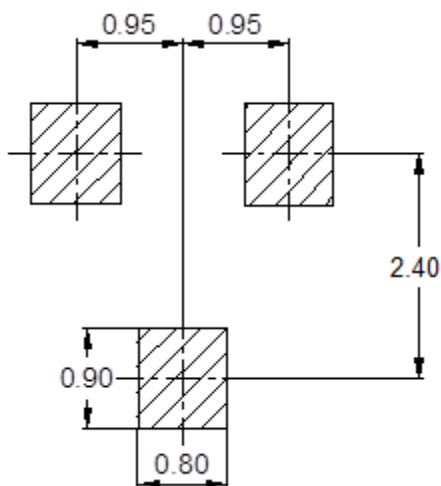

Unit : mm

### PACKAGE INFORMATION

Device	Package	Shipping
2SC3356-R25	SOT-23-3L	3000/Tape&Reel