



BCT646

2:1 MIPI C-PHY,D-PHY(4.5Gbps) 4-Data Lane Switch

BCT646

2:1 MIPI D-PHY(4.5Gbps) 4-Data Lane Switch

GENERAL DESCRIPTION

The BCT646 is a four-data-lane MIPI D-PHY, C-PHY switch. This single-pole, double-throw (SPDT) switch is optimized for switching between two high-speed or low-power MIPI sources. The BCT646 is designed for the MIPI specification and allows connection to a CSI or DSI module.

APPLICATIONS

Cellular Phones, Smart Phones

Displays

Tablets

Laptops

FEATURES

- Switch Type: SPDT(10x)
- Signal Types: MIPI D-PHY,C-PHY
- V_{CC} :1.5 to 5.0V
- Input Signals: 0 to 1.3V
- R_{ON} : 6.5 Ω Typical HS MIPI
6.5 Ω Typical LP MIPI
- ΔR_{ON} : 0.15 Ω Typical HS &LP MIPI
- R_{ON_FLAT} : 0.2 Ω Typical
- I_{CCZ} : 1uA Maximum
- I_{CC} : 35uA Maximum
- O_{IRR} :-25dB Typical
- X_{TALK} :-30dB Typical
- Differential Bandwidth: 4.5 GHz Typical
- Channel-to-Channel Skew: 6ps Typical
- C_{ON} :1.5pF
- 36-Ball WLCSP Package

ORDERING INFORMATION

Order Number	Package Type	Temperature Range	Marking	QTY/Reel
BCT646EWX-TR	WLCSP-36L	-40°C to +85°C	646	3000

ORDER NUMBER

BCT646 X XX -TR

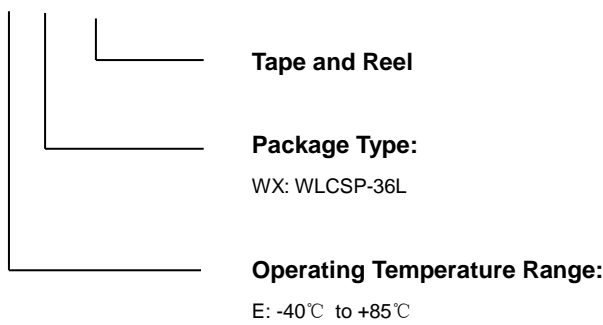

TYPICAL OPERATING CIRCUIT

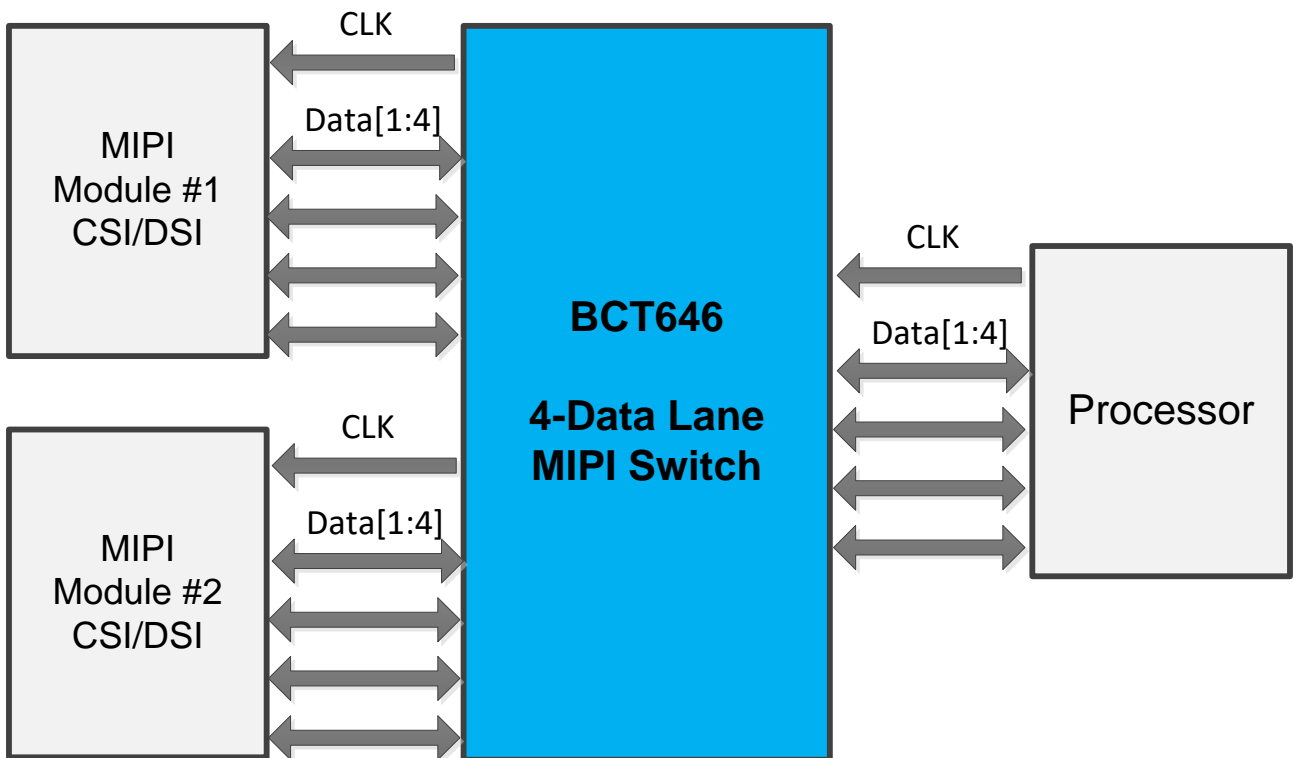

Figure 1. Application Block Diagram



BCT646

2:1 MIPI C-PHY,D-PHY(4.5Gbps) 4-Data Lane Switch

ABSOLUTE MAXIMUM RATINGS

Supply Voltage (V_{CC}).....	-0.5V to +6.0V
DC Input Voltage (SEL, /OE) ⁽¹⁾	-0.5V to V_{CC} V
DC Switch I/O Voltage.....	-0.5V to 1.8V
DC Input Diode Current.....	-50mA
DC Output Current	25mA
Storage Temperature Range.....	-65°C to +150°C
Junction Temperature.....	150°C
Operating Temperature Range.....	-40°C to +85°C
Lead Temperature (Soldering, 10 sec).....	260°C
ESD Susceptibility	
HBM All Pins.....	2.0KV
CDM.....	1KV
IEC 61000-4-2 System (Contact).....	8KV
IEC 61000-4-2 System (Air Gap).....	15KV

CAUTION

This integrated circuit can be damaged by ESD if you don't pay attention to ESD protection. Broadchip recommends that all integrated circuits be handled with appropriate precautions. Failure to observe proper handling and installation procedures can cause damage. ESD damage can range from subtle performance degradation to complete device failure. Precision integrated circuits may be more susceptible to damage because very small parametric changes could cause the device not to meet its published specifications.

Broadchip reserves the right to make any change in circuit design, specification or other related things if necessary without notice at any time. Please contact Broadchip sales office to get the latest datasheet.

RECOMMENDED OPERATING CONDITONS

The Recommended Operating Conditions table defines the conditions for actual device operation. Recommended operating conditions are specified to ensure optimal performance to the datasheet specifications.

Symbol	Parameter	Min.	Max.	Unit	
V_{CC}	Supply Voltage	1.5	5.0	V	
V_{CTRL}	Control Input Voltage(SEL, /OE) ⁽²⁾	0	V_{CC}	V	
V_{SW}	Switch I/O Voltage (CLKn, CLKA _n , CLKB _n , Dn, DAN, DBn)	HS Mode	0	0.3	V
		LP Mode	0	1.3	
T_A	Operating Temperature	-40	+85	°C	

Notes:

1. The input and output negative ratings maybe exceed if the input and output diode current ratings are observed.
2. The control input must be held HIGH or LOW; it must not float.

PIN CONFIGURATION

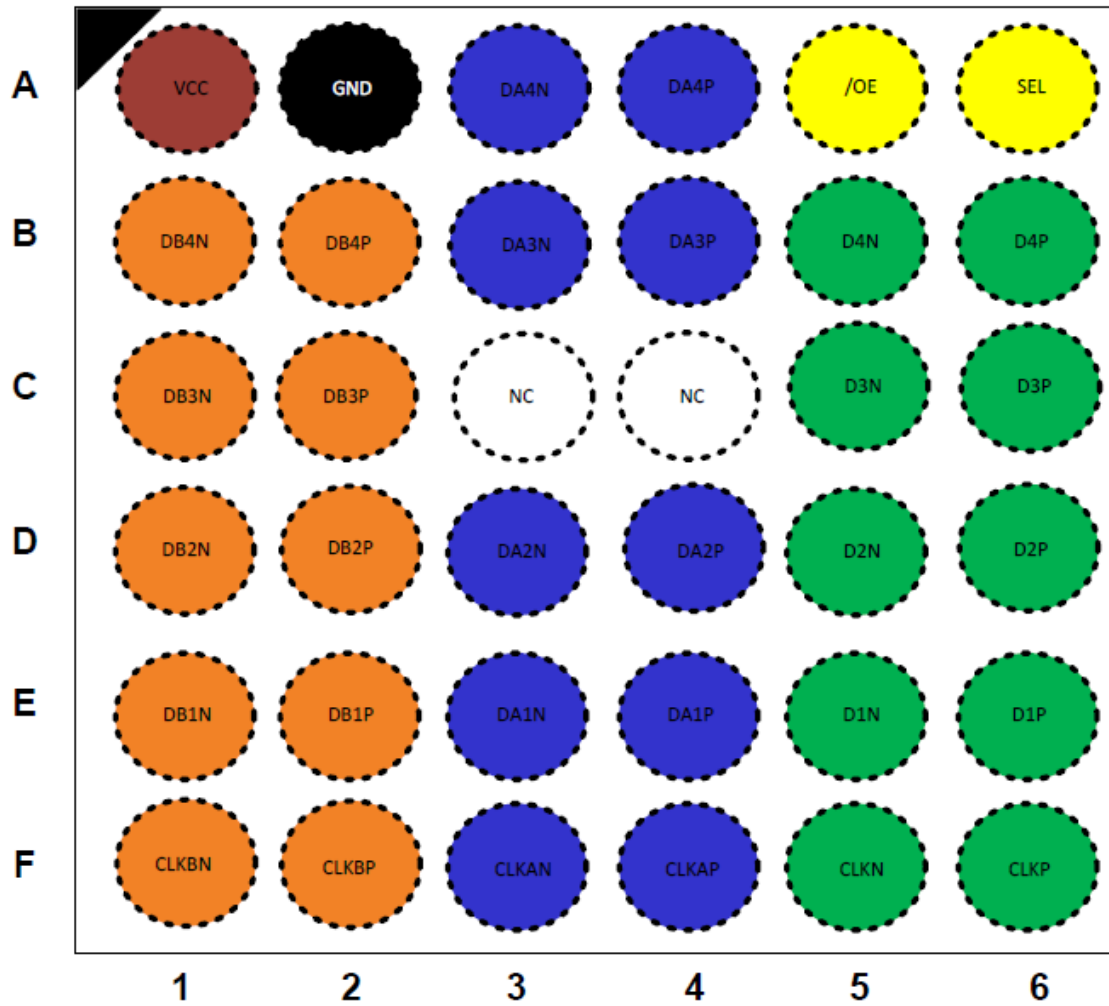

Figure2. Pin Configuration(Top Through View)



BCT646

2:1 MIPI C-PHY,D-PHY(4.5Gbps)

4-Data Lane Switch

Table 1. Ball-to-Pin Mappings

Ball	Pin Name
A1	V _{CC}
A2	GND
A3	DA4N
A4	DA4P
A5	/OE
A6	SEL
B1	DB4N
B2	DB4P
B3	DA3N
B4	DA3P
B5	D4N
B6	D4P
C1	DB3N
C2	DB3P
C3	NC
C4	NC
C5	D3N
C6	D3P
D1	DB2N
D2	DB2P
D3	DA2N
D4	DA2P
D5	D2N
D6	D2P
E1	DB1N
E2	DB1P
E3	DA1N
E4	DA1P
E5	D1N
E6	D1P
F1	CLKBN
F2	CLKBP
F3	CLKAN
F4	CLKAP
F5	CLKN
F6	CLKP

TRUTH TABLE

SEL	/OE	Function
LOW	LOW	CLKP=CLKAP, CLKN=CLKAN, D _N (P/N)=DA _N (P/N)
HIGH	LOW	CLKP=CLKBP, CLKN=CLKBN, D _N (P/N)=DB _N (P/N)
X	HIGH	Clock and Data Ports High Impedance

PIN DESCRIPTION

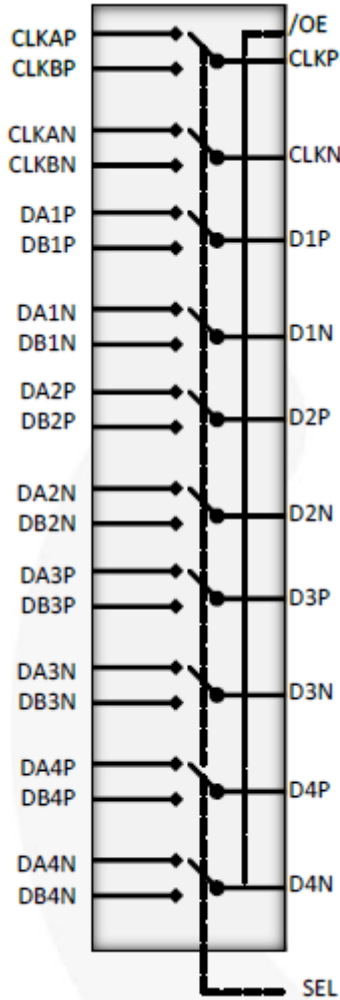

Figure 3. Analog Symbol

Pin Name	Description	
CLKP/N	Common Clock Path	
D1P/N	Common Data Path1	
D2P/N	Common Data Path2	
D3P/N	Common Data Path3	
D4P/N	Common Data Path4	
CLKAP/N	A-Side Clock Path	
DA1P/N	A-Side Data Path 1	
DA2P/N	A-Side Data Path 2	
DA3P/N	A-Side Data Path 3	
DA4P/N	A-Side Data Path 4	
CLKBP/N	B-Side Clock Path	
DB1P/N	B-Side Data Path 1	
DB2P/N	B-Side Data Path 2	
DB3P/N	B-Side Data Path 3	
DB4P/N	B-Side Data Path 4	
SEL	SEL=0	CLKP=CLKAP, CLKN=CLKAN, Dn(P/N)=DAn(P/N)
	SEL=1	CLKP=CLKBP, CLKN=CLKBN, Dn(P/N)=DBn(P/N)
/OE	Output Enable	
VCC	Power	
GND	Ground	
NC	No Connect	

DC ELECTRICAL CHARACTERISTICS

(All typical values are $T_A = 25^\circ\text{C}$, unless otherwise specified.)

PARAMETER	SYM	CONDITIONS	V _{CC} (V)	MIN	TYP	MAX	UNITS
Control Input Leakage(SEL, /OE)	I _{IN}	V _{CNTRL} =0 to V _{CC}	5	-1		1	uA
Input Voltage High	V _{IH}	SEL, /OE	1.5 to 5	1.4			V
Input Voltage Low	V _{IL}	SEL, /OE	1.5 to 5			0.4	V
Off leakage Current of Port CLKAn, DAn, CLKBn, DBn	I _{NO(OFF)} I _{NC(OFF)}	V _{SW} =0≤DATA≤1.3V	5	-1		1	uA
On leakage Current of Common Ports(CLK _n , D _n)	I _{A(ON)}	V _{SW} =0≤DATA≤1.3V	5	-1		1	uA
Power-Off Leakage Current (All I/O Ports)	I _{OFF}	V _{SW} =0 or 1.3V	0	-1		1	uA
Off-State Leakage	I _{OZ}	V _{SW} =0≤DATA≤1.3V, /OE=High	5	-1		1	uA
Switch On Resistance for HS MIPI Applications ⁽³⁾	R _{ON_MIPI_HS}	I _{ON} =-8mA, /OE=0V, SEL=V _{CC} or 0V, CLKA, CLKB, DBn or DAn=0.3V	1.5 to 5		6.5	9	Ω
Switch On Resistance for LP MIPI Applications ⁽³⁾	R _{ON_MIPI_LP}	I _{ON} =-8mA, /OE=0V, SEL=V _{CC} or 0V, CLKA, CLKB, DBn or DAn=1.3V	1.5 to 5		6.5	9	Ω
On Resistance Matching Between HS MIPI Channels ⁽⁴⁾	Δ R _{ON_MIPI_HS}	I _{ON} =-8mA, /OE=0V, SEL=V _{CC} or 0V, CLKA, CLKB, DBn or DAn=0.3V	1.5 to 5		0.15		Ω

DC ELECTRICAL CHARACTERISTICS

(All typical values are $T_A = 25^\circ\text{C}$, unless otherwise specified.)

PARAMETER	SYM	CONDITIONS	V _{CC} (V)	MIN	TYP	MAX	UNITS
On Resistance Matching Between LP MIPI Channels ⁽⁴⁾	Δ R _{ON_MIPI_LP}	I _{ON} =-8mA, /OE=0V, SEL=V _{CC} or 0V, CLKA, CLKB, DBn or DAN=1.3V	1.5 to 5		0.15		Ω
On Resistance Flatness for HS MIPI Signals ⁽⁴⁾	R _{ON_FLAT_MIPI_HS}	I _{ON} =-8mA, /OE=0V, SEL=V _{CC} or 0V, CLKA, CLKB, DBn or DAN=0 to 0.3V	1.5 to 5		0.2		Ω
On Resistance Flatness for LP MIPI Signals ⁽⁴⁾	R _{ON_FLAT_MIPI_LP}	I _{ON} =-8mA, /OE=0V, SEL=V _{CC} or 0V, CLKA, CLKB, DBn or DAN=0 to 1.3V	1.5 to 5		0.2		Ω
Quiescent Hi-Z Supply Current	I _{CCZ}	V _{SEL} =0 or V _{CC} , I _{OUT} =0, /OE=V _{CC}	5			1	μA
Quiescent Supply Current (Includes Charge Pump)	I _{CC}	V _{SEL} =0 or V _{CC} , I _{OUT} =0, /OE=0V	5			35	μA

Notes:

3. Measured by the voltage drop between A and B pins at the indicated current through the switch. On resistance is determined by the lower of the voltage on the two (A or B ports).
4. Guaranteed by characterization

AC ELECTRICAL CHARACTERISTICS

(All values are for V_{CC}=3.3V at T_A=25°C unless otherwise specified.)

PARAMETER	SYM	CONDITIONS	V _{CC} (V)	MIN	TYP	MAX	UNITS
Initialization Time VCC to Output ⁽⁵⁾	t _{INIT}	R _L =50 Ω , C _L =0pF, V _{SW} =0.6V	1.5 to 5		60		μs
Enable Turn-On Time, /OE to Output	t _{EN}	R _L =50 Ω , C _L =0pF, V _{SW} =0.6V	1.5 to 5		60	150	μs
Disable Turn-off Time, /OE to Output	t _{DIS}	R _L =50 Ω , C _L =0pF, V _{SW} =0.6V	1.5 to 5		35	250	ns
Turn-On Time SEL to Output	t _{ON}	R _L =50 Ω , C _L =0pF, V _{SW} =0.6V	1.5 to 5		350	1100	ns

AC ELECTRICAL CHARACTERISTICS

(All values are for $V_{CC}=3.3V$ at $T_A=25^{\circ}C$ unless otherwise specified.)

PARAMETER	SYM	CONDITIONS	V_{CC} (V)	MIN	TYP	MAX	UNITS
Turn-Off Time SEL to Output	t_{OFF}	$R_L=50\Omega$, $C_L=0pF$, $V_{SW}=0.6V$	1.5 to 5		125	800	ns
Break-Before-Make Time	t_{BBM}	$R_L=50\Omega$, $C_L=0pF$, $V_{SW}=0.6V$	1.5 to 5	50		450	ns
Propagation Delay ⁽⁵⁾	t_{PD}	$C_L=0pF$, $R_L=50\Omega$	1.5 to 5		0.25		ns
Off Isolation for MIPI ⁽⁵⁾	O_{IRR}	$f=1250MHz$, $R_L=50\Omega$, /OE=HIGH, $V_{SW}=200mV_{PP}$	1.5 to 5		-25		dB
Crosstalk for MIPI ⁽⁵⁾	X_{TALK}	$f=1250MHz$, $R_L=50\Omega$, /OE=High, $V_{SW}=200mV_{PP}$	1.5 to 5		-30		dB
		$f=1250MHz$, $R_L=50\Omega$, /OE=Low, $V_{SW}=200mV_{PP}$	1.5 to 5		-30		dB
Differential -3db Bandwidth ⁽⁵⁾	BW	$C_L=0pF$, $R_L=50\Omega$, $V_{SW}=200mV_{PP}$	1.5 to 5		4.5		GHz

Note:

5. Guaranteed by characterization.

HIGH-SPEED-RELATED AC ELECTRICAL CHARACTERISTICS

PARAMETER	SYM	CONDITIONS	V_{CC} (V)	MIN	TYP	MAX	UNITS
HS Mode Skew of Opposite Transitions of the Same Output ⁽⁶⁾	$t_{SK(P)}$	$R_L=50\Omega$, $C_L=0pF$, $V_{SW}=0.3V$	1.5 to 5		6		ps

Note:

6. Guaranteed by characterization.

CAPACITANCE

PARAMETER	SYM	CONDITIONS	V_{CC} (V)	MIN	TYP	MAX	UNITS
Control Pin Input Capacitance ⁽⁷⁾	C_{IN}	$V_{CC}=0V$, $f=1MHz$	0		2.1		pF
Output On Capacitance ⁽⁷⁾	C_{ON}	$V_{CC}=3.3V$, /OE=0V, $f=1250MHz$ (In HS common value)	3.3		1.5		
Output Off Capacitance ⁽⁷⁾	C_{OFF}	V_{CC} and /OE=3.3V, $f=1250MHz$ (Both sides in HS common value)	3.3		0.9		

Note:

7. Guaranteed by characterization.

TEST DIAGRAMS

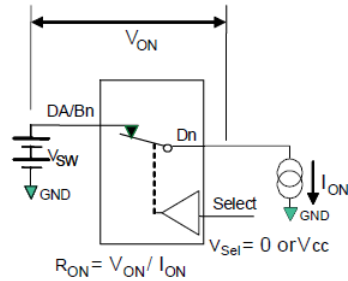
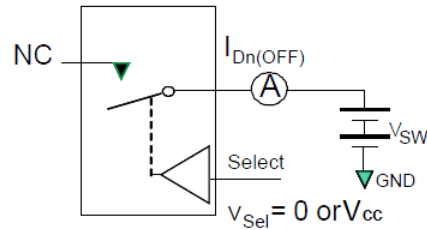
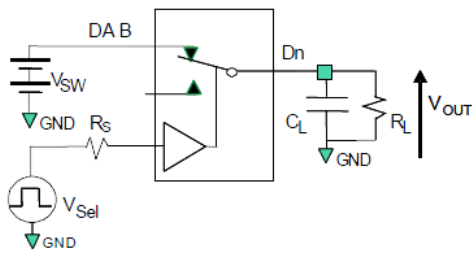

Figure 4. On Resistance



**Each switch port is tested separately

Figure 5. Off Leakage



$R_L, R_S, \text{ and } C_L$ are functions of the application environment (see AC Tables for specific values). C_L includes test fixture and stray capacitance

Figure 6. AC Test Circuit Board

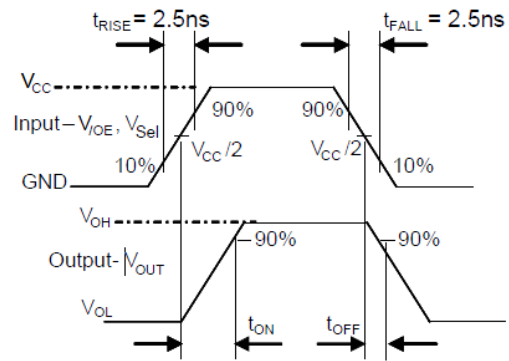

Figure 7. Turn-On/Turn-Off waveform

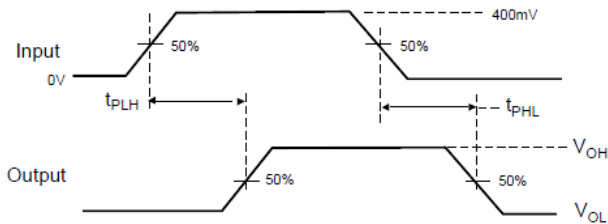

Figure 8. Propagation Delay ($t_{RtF} < 500ps$)

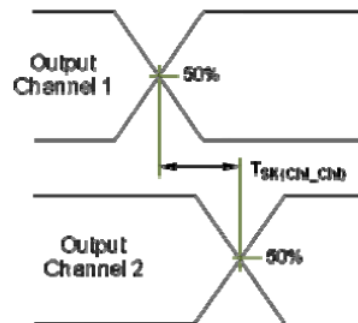

Figure 9. Channel to Channel Skew

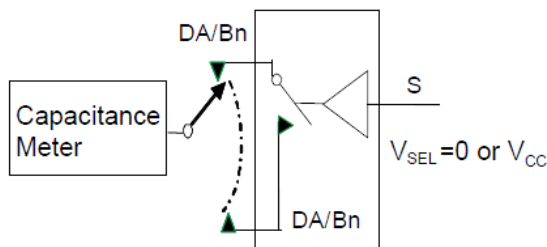

Figure 10. Channel Off Capacitance

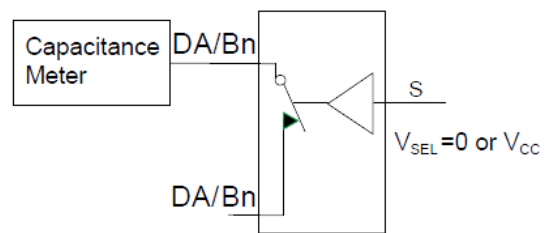

Figure 11. Channel On Capacitance

TEST DIAGRAMS(CONTINUED)

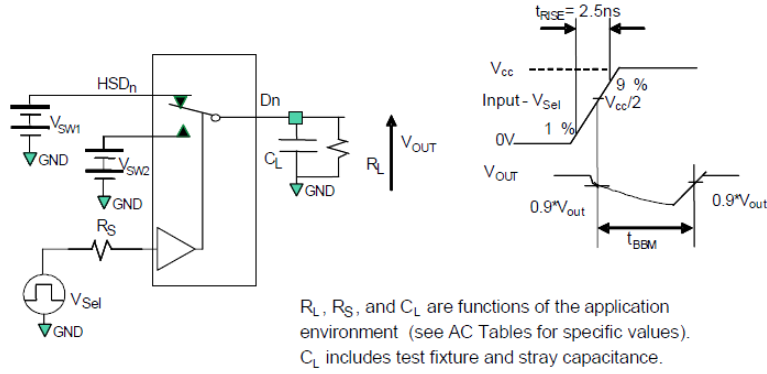
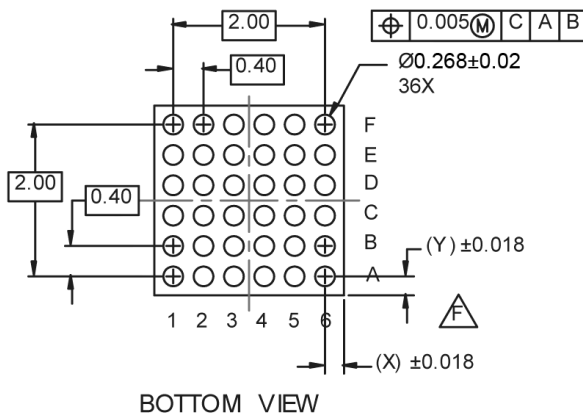
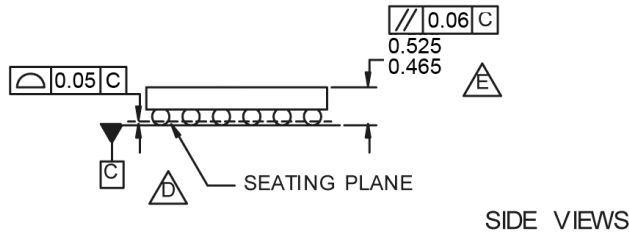
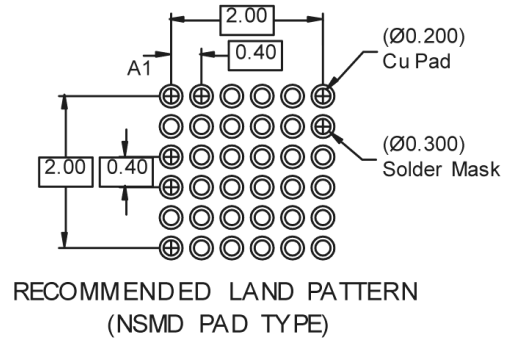
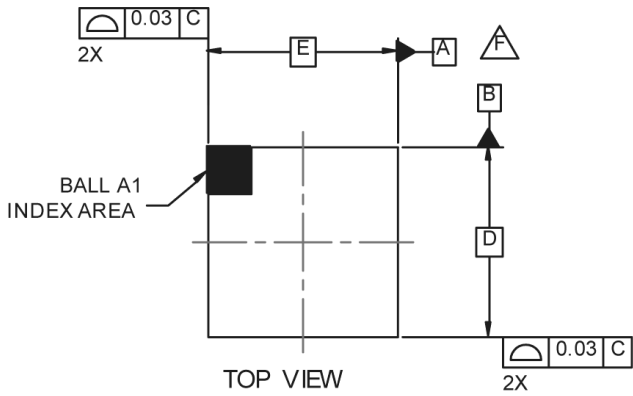





Figure 12. Break-Before-Make Interval Timing

PACKAGE OUTLINE DIMENSIONS



NOTES

- A. NO JEDEC REGISTRATION APPLIES.
- B. DIMENSIONS ARE IN MILLIMETERS.
- C. DIMENSIONS AND TOLERANCE PER ASMEY14.5M, 1994.
-  DATUM C IS DEFINED BY THE SPHERICAL CROWNS OF THE BALLS.
-  PACKAGE NOMINAL HEIGHT IS 495±30 MICRONS (465-525 MICRONS).
-  FOR DIMENSIONS D, E, X, AND Y SEE PRODUCT DATASHEET.
- G. DRAWING FILNAME: MKT-UC036AArev1.

Product-Specific Dimensions (Unit: mm)

Product	Package	D	E	X	Y
BCT646EWX-TR	36-Ball WLCSP	2.370 ±0.02	2.370 ±0.02	0.175	0.175