

Specification for Approval

Date: 2021/08/16

Customer : 天诚科技

TAI-TECH P/N: ACM4532F2NV-510T02-D

CUSTOMER P/N:

DESCRIPTION:

QUANTITY:

| | |
|----------------------------|--|
| REMARK: | |
| Customer Approval Feedback | |
| | |

西北臺慶科技股份有限公司
TAI-TECH Advanced Electronics Co., Ltd

代理商:

- 深圳市天诚科技有限公司
 Shenzhen TsaSun Technology Co., Ltd.
 Room 209, 2/F, Block A, Tengfei Industrial Building, No.6,
 Taohua Road, Futian District, Shenzhen
 TEL: 0755-8335 8885 / 0755-8335 9885
 E-mail: sales@tsasun.com
 www.tsacoil.com

- 西北臺慶科技股份有限公司
 TAI-TECH Advanced Electronics Co., Ltd
Headquarter:
 NO.1 YOU 4TH ROAD, YOUTH INDUSTRIAL DISTRICT, YANG-MEI,
 TAO-YUAN HSIEN, TAIWAN, R.O.C.
 TEL: +886-3-4641148 FAX: +886-3-4643565
 http://www.tai-tech.com.tw
 E-mail: sales@tai-tech.com.tw

- 臺慶精密電子(昆山)有限公司
 TAI-TECH ADVANCED ELECTRONICS(KUNSHAN) CO., LTD
 SHINWHA ROAD, KUNJIA HI-TECH INDUSTRIAL PARK, KUN-SHAN,
 JIANG-SU, CHINA
 TEL: +86-512-57619396 FAX: +86-512-57619688
 E-mail: hui@tai-tech.com.tw

Sales Dep.

| APPROVED | CHECKED |
|----------|---------|
| 夏曉曼 | 夏曉曼 |

R&D Center

| APPROVED | CHECKED | DRAWN |
|----------|---------|-------|
| 羅宜春 | 梁周虎 | 卜文娟 |

Wire Wound Type Common Mode Filter

ACM4532F2NV-510T02-D

1. Features

1. High common mode impedance at high frequency effects excellent noise suppression performance.
2. ACM4532F2NV series realizes small size and low profile. 4.5x3.2x2.8 mm.
3. 100% Lead(Pb) & Halogen-Free and RoHS compliant.
4. High reliability -Reliability tests comply with AEC-Q200



2. Dimension

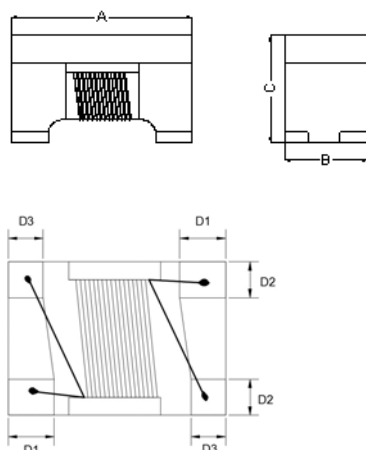

Recommended PC Board Pattern

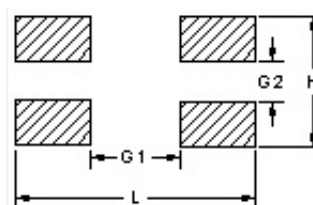

| Series | A(mm) | B(mm) | C(mm) | D1(mm) | D2(mm) | D3(mm) | L(mm) | H(mm) | G1(mm) | G2(mm) |
|----------|---------|---------|---------|----------|----------|----------|-------|-------|--------|--------|
| 4532F2NV | 4.5±0.2 | 3.2±0.2 | 2.8±0.2 | 0.75±0.2 | 0.85±0.2 | 0.60±0.2 | 5.0 | 3.6 | 3.4 | 1.7 |

3. Part Numbering

ACM
4532
F
2
N
V
-
510
T
02
-
D

A B C D E F G H I J

- A: Series
 B: Dimension
 C: Material Ferrite Core
 D: Number of Lines 2=2 lines
 E: Type N45
 F: Category Code V=Vehicle
 G: Inductance 510=51uH
 H: Packaging T=Taping and Reel
 I: Rated Current 02=230mA
 J: Control S/N

4. Specification

| TAI-TECH Part Number | Common mode Impedance (Ω) [10MHz] | | Inductance (μH)+50/-30% [100kHz/0.1V] | DC Resistance (Ω) max. | Rated Current (mA) | Rated Volt. (Vdc) | IR (MΩ) min. |
|-------------------------|---|-----------|---|------------------------------|--------------------------|-------------------------|--------------------|
| | 1000 min. | 2800 typ. | | | | | |
| ACM4532F2NV-510T02-D | 1000 min. | 2800 typ. | 51 | 1.0 | 230 | 50 | 10 |

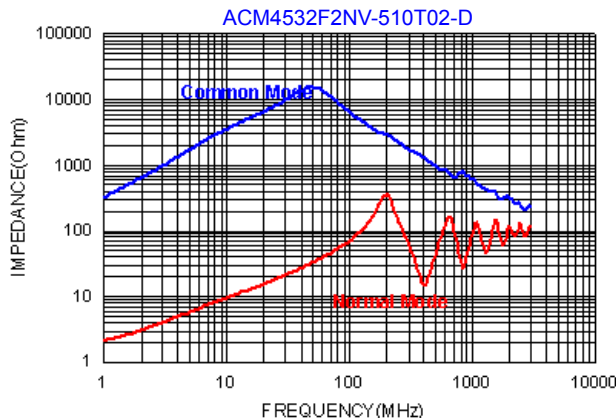

5.Schematic Diagram

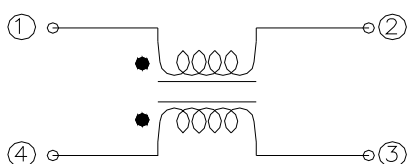

6. MEASURING CIRCUITS 2LINE

Common mode

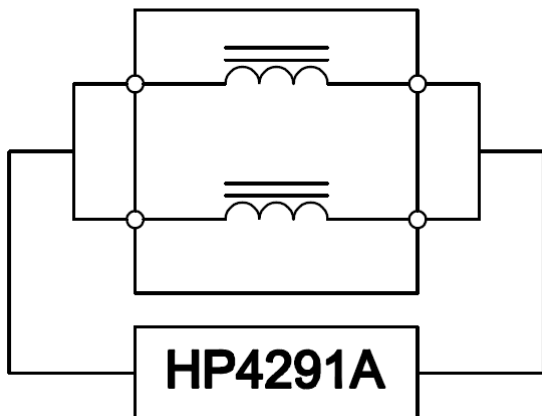

Differential mode

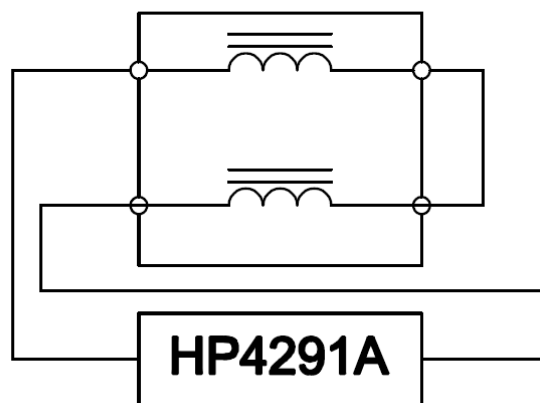

7. Materials

| No. | Description | Specification |
|-----|-------------|----------------------|
| a. | Upper Plate | Ferrite |
| b. | Core | Ferrite Core |
| c. | Termination | Tin (Pb Free) |
| d. | Wire | Enameled Copper Wire |

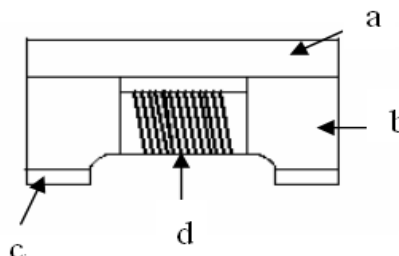

8. Reliability and Test Condition

| Item | Performance | Test Condition | | | | | | | | | | | | | | | |
|--|---|---|---|----------------------------|--------------------------|-----------|----------------------------|-----|-----|---|-----------|------|------|-----|---|-----------|------|
| Operating temperature | -55~+150°C (Including self - temperature rise) | | | | | | | | | | | | | | | | |
| Storage temperature and Humidity range | -55~+125°C (on board) | | | | | | | | | | | | | | | | |
| Electrical Performance Test | | | | | | | | | | | | | | | | | |
| L(common mode) | Refer to standard electrical characteristics list. | Agilent-4291A+ Agilent -16197A | | | | | | | | | | | | | | | |
| DCR | | Agilent-4338B | | | | | | | | | | | | | | | |
| I.R. | | Agilent4339 | | | | | | | | | | | | | | | |
| Temperature Rise Test | Rated Current < 1A ΔT 20°C Max Rated Current \geq 1A ΔT 40°C Max | 1.Applied the allowed DC current. 2.Temperature measured by digital surface thermometer | | | | | | | | | | | | | | | |
| Reliability Test | | | | | | | | | | | | | | | | | |
| High Temperature Exposure(Storage) AEC-Q200 | Appearance : No damage. Impedance : within \pm 15% of initial value Inductance : within \pm 10% of initial value Q : Shall not exceed the specification value. RDC : within \pm 15% of initial value and shall not exceed the specification value | Preconditioning: Run through IR reflow for 2 times.(IPC/JEDEC J-STD-020DCclassification Reflow Profiles Temperature : 150 \pm 2°C Duration : 1000hrs Min. Measured at room temperature after placing for 24 \pm 2 hrs | | | | | | | | | | | | | | | |
| Temperature Cycling AEC-Q200 | | Preconditioning: Run through IR reflow for 2 times.(IPC/JEDEC J-STD-020DCclassification Reflow Profiles Condition for 1 cycle Step1 : -55 \pm 2°C 30min Min. Step2 : 150 \pm 2°C transition time 1min MAX. Step3 : 150 \pm 2°C 30min Min. Step4 : Low temp. transition time 1min MAX. Number of cycles : 1000 Measured at room temperature after placing for 24 \pm 2 hrs | | | | | | | | | | | | | | | |
| Moisture Resistance | | Preconditioning: Run through IR reflow for 2 times.(IPC/JEDEC J-STD-020DCclassification Reflow Profiles 1.Baked at50°C for 25hrs, measured at room temperature after placing for 4 hrs. 2.Raise temperature to 65 \pm 2°C 90-100%RH in 2.5hrs, and keep 3 hours, cool down to 25°C in 2.5hrs. 3.Raise temperature to 65 \pm 2°C 90-100%RH in 2.5hrs, and keep 3 hours, cool down to 25°C in 2.5hrs,keep at 25°C for 2hrs then keep at -10°C for 3hrs 4.Keep at 25°C 80-100%RH for 15min and vibrate at the frequency of 10 to 55 Hz to 10 Hz, measure at room temperature after placing for 1~2 hrs. | | | | | | | | | | | | | | | |
| Biased Humidity (AEC-Q200) | | Preconditioning: Run through IR reflow for 2 times.(IPC/JEDEC J-STD-020DCclassification Reflow Profiles Humidity : 85 \pm 3%R.H, Temperature : 85°C \pm 2°C Duration : 1000hrs Min with 100% rated current. Measured at room temperature after placing for24 \pm 2hrs | | | | | | | | | | | | | | | |
| High Temperature Operational Life (AEC-Q200) | | Preconditioning: Run through IR reflow for 2 times.(IPC/JEDEC J-STD-020DCclassification Reflow Profiles Temperature : 150 \pm 2°C Duration : 1000hrs Min. with 100% rated current. Measured at room temperature after placing for24 \pm 2hrs | | | | | | | | | | | | | | | |
| External Visual | | Appearance : No damage. | Inspect device construction, marking and workmanship. Electrical Test not required. | | | | | | | | | | | | | | |
| Physical Dimension | According to the product specification size measurement | According to the product specification size measurement | | | | | | | | | | | | | | | |
| Resistance to Solvents | Appearance : No damage. | Add aqueous wash chemical - OKEM clean or equivalent. | | | | | | | | | | | | | | | |
| Mechanical Shock | Appearance : No damage. Impedance : within \pm 15% of initial value Inductance : within \pm 10% of initial value Q : Shall not exceed the specification value. RDC : within \pm 15% of initial value and shall not exceed the specification value | <table border="1"> <thead> <tr> <th>Type</th> <th>Peak value (g's)</th> <th>Normal duration (D) (ms)</th> <th>Wave form</th> <th>Velocity change (Vi)ft/sec</th> </tr> </thead> <tbody> <tr> <td>SMD</td> <td>100</td> <td>6</td> <td>Half-sine</td> <td>12.3</td> </tr> <tr> <td>Lead</td> <td>100</td> <td>6</td> <td>Half-sine</td> <td>12.3</td> </tr> </tbody> </table> shocks in each direction along 3 perpendicular axes. | Type | Peak value (g's) | Normal duration (D) (ms) | Wave form | Velocity change (Vi)ft/sec | SMD | 100 | 6 | Half-sine | 12.3 | Lead | 100 | 6 | Half-sine | 12.3 |
| Type | Peak value (g's) | Normal duration (D) (ms) | Wave form | Velocity change (Vi)ft/sec | | | | | | | | | | | | | |
| SMD | 100 | 6 | Half-sine | 12.3 | | | | | | | | | | | | | |
| Lead | 100 | 6 | Half-sine | 12.3 | | | | | | | | | | | | | |

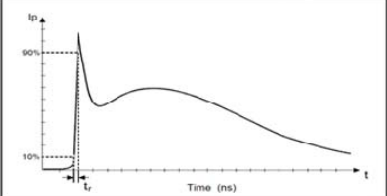
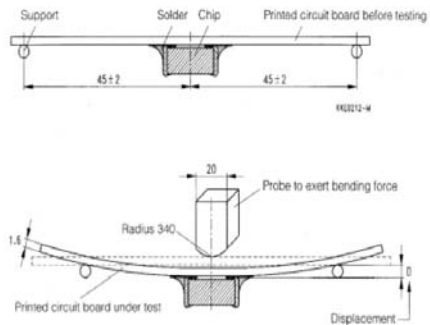
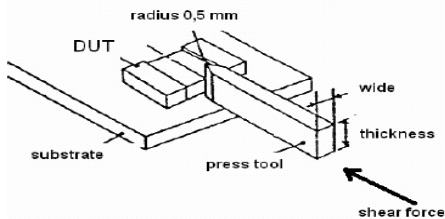
| Item | Performance | Test Condition | | | | | | | | |
|------------------------------|--|---|-----------------------|---------|--|-----------------------|--------------------|------|----------------|---|
| Vibration | | IPC/JEDEC J-STD-020D Classification Reflow Profiles Oscillation Frequency: 10~2K~10Hz for 20 minute Equipment : Vibration checker Total Amplitude: 1.52mm±10% Testing Time : 12 hours(20 minutes, 12 cycles each of 3 orientations) | | | | | | | | |
| Resistance to Soldering Heat | Appearance : No damage. Impedance : within±15% of initial value Inductance : within±10% of initial value Q : Shall not exceed the specification value. RDC : within ±15% of initial value and shall not exceed the specification value | Test condition : <table border="1" data-bbox="965 371 1422 524"> <thead> <tr> <th>Temperature(°C)</th> <th>Time(s)</th> <th>Temperature ramp/immersion and emersion rate</th> <th>Number of heat cycles</th> </tr> </thead> <tbody> <tr> <td>260±5(solder temp)</td> <td>10±1</td> <td>25mm/s ±6 mm/s</td> <td>1</td> </tr> </tbody> </table> | Temperature(°C) | Time(s) | Temperature ramp/immersion and emersion rate | Number of heat cycles | 260±5(solder temp) | 10±1 | 25mm/s ±6 mm/s | 1 |
| Temperature(°C) | Time(s) | Temperature ramp/immersion and emersion rate | Number of heat cycles | | | | | | | |
| 260±5(solder temp) | 10±1 | 25mm/s ±6 mm/s | 1 | | | | | | | |
| Thermal shock (AEC-Q200) | | Preconditioning: Run through IR reflow for 2 times.(IPC/JEDEC J-STD-020D Classification Reflow Profiles Condition for 1 cycle Step1 : -55±2°C 15±1min Step2 : 150±2°C within 20Sec. Step3 : 150±2°C 15±1min Number of cycles : 300 Measured at room tempratur after placing fo24±2hrs | | | | | | | | |
| ESD | Appearance : No damage. |  | | | | | | | | |
| Solderability | More than 95% of the terminal electrode should be covered with solder. | Steam Aging: 16 hours ± 15 min Preheat: 150°C, 60sec. Solder: Sn96.5% Ag3% Cu0. 5% Temperature: 245±5°C Flux for lead free: Rosin. 9.5% Dip time: 4±1sec. Depth: completely cover the termination | | | | | | | | |
| Electrical Characterization | Refer Specification for Approval | Summary to show Min, Max, Mean and Standard deviation . | | | | | | | | |
| Flammability | Electrical Test not required. | V-0 or V-1 are acceptable. | | | | | | | | |
| Board Flex | Appearance : No damage | Preconditioning: Run through IR reflow for 2 times.(IPC/JEDEC J-STD-020D Classification Reflow Profiles Place the 100mm X 40mm board into a fixture similar to the one shown in below Figure with the component facing down. The apparatus shall consist of mechanical means to apply a force which will bend the board (D) x = 2 mm minimum. The duration of the applied forces shall be 60 (+ 5) sec. The force is to be applied only once to the board.  | | | | | | | | |
| Terminal Strength(SMD) | Appearance : No damage | Preconditioning: Run through IR reflow for 2 times.(IPC/JEDEC J-STD-020D Classification Reflow Profiles With the component mounted on a PCB with the device to be tested, apply a 17.7 N (1.8 Kg) force to the side of a device being tested. This force shall be applied for 60 +1 seconds. Also the force shall be applied gradually as not to apply a shock to the component being tested.  | | | | | | | | |

9. Soldering and Mounting

9-1. Soldering

Mildly activated rosin fluxes are preferred. TAI-TECH terminations are suitable for all wave and re-flow soldering systems. If hand soldering cannot be avoided, the preferred technique is the utilization of hot air soldering tools.

9-1.1 Solder re-flow:

Recommended temperature profiles for re-flow soldering in Figure 1.

9-1.2 Soldering Iron(Figure 2):

Products attachment with a soldering iron is discouraged due to the inherent process control limitations. In the event that a soldering iron must be employed the following precautions are recommended.

- Preheat circuit and products to 150°C
- Never contact the ceramic with the iron tip
- Use a 20 watt soldering iron with tip diameter of 1.0mm
- 350°C tip temperature (max)
- 1.0mm tip diameter (max)
- Limit soldering time to 4~5 sec.

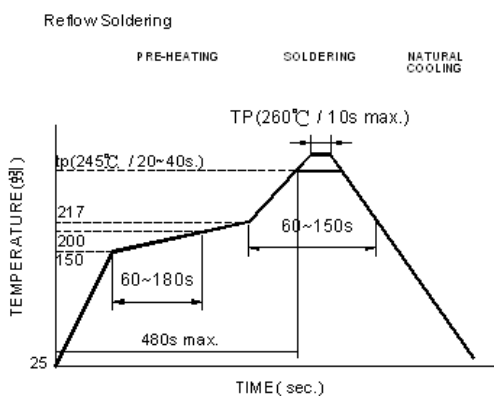

Reflow times: 3 times max.

Fig.1

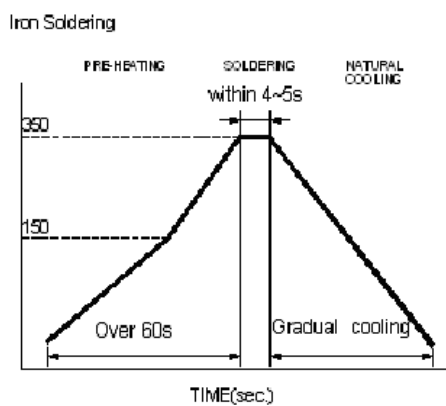

Iron Soldering times: 1 times max.

Fig.2

10. Packaging Information

10-1. Reel Dimension

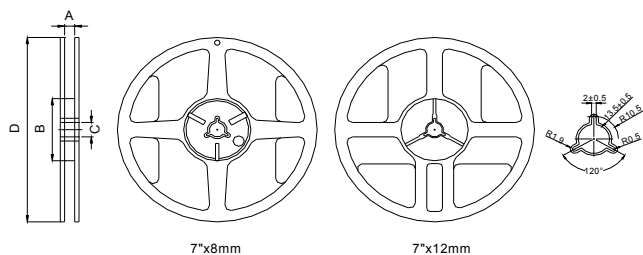

| Type | A(mm) | B(mm) | C(mm) | D(mm) |
|---------|----------|-------|----------|-------|
| 7"x12mm | 13.5±0.5 | 60±2 | 13.5±0.5 | 178±2 |

10-2. Tape Dimension / 12mm

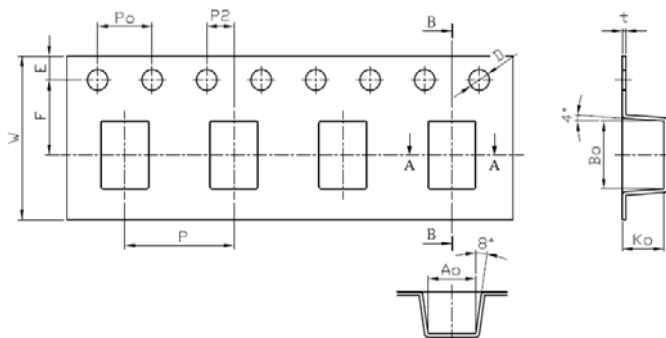

| Series | P(mm) | Po(mm) | P2(mm) | Bo(mm) | Ao(mm) | Ko(mm) | D(mm) | E(mm) | F(mm) | W(mm) | t(mm) |
|------------|-----------|-----------|-----------|-----------|-----------|-----------|-----------------|-----------|-----------|------------|-----------|
| ACM4532F2N | 8.00±0.10 | 4.00±0.10 | 2.00±0.05 | 4.90±0.10 | 3.60±0.10 | 3.00±0.10 | 1.05+0.10/-0.00 | 1.75±0.10 | 5.50±0.05 | 12.00±0.10 | 0.26±0.05 |

10-3. Packaging Quantity

| Chip size | Chip/Reel | Inner Box | Middle Box | Carton |
|------------|-----------|-----------|------------|--------|
| ACM4532F2N | 500 | 2000 | 10000 | 20000 |

10-4. Tearing Off Force

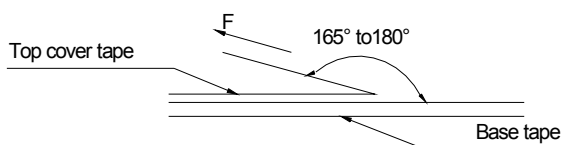

The force for tearing off cover tape is 15 to 80 grams in the arrow direction under the following conditions.

| Room Temp. (°C) | Room Humidity (%) | Room atm (hPa) | Tearing Speed mm/min |
|-----------------|-------------------|----------------|----------------------|
| 5~35 | 45~85 | 860~1060 | 300 |

Application Notice

- Storage Conditions(component level)
 - To maintain the solderability of terminal electrodes:
 1. TAI-TECH products meet IPC/JEDEC J-STD-020D standard-MSL, level 1.
 2. Temperature and humidity conditions: Less than 40°C and 60% RH.
 3. Recommended products should be used within 12 months form the time of delivery.
 4. The packaging material should be kept where no chlorine or sulfur exists in the air.
- Transportation
 1. Products should be handled with care to avoid damage or contamination from perspiration and skin oils.
 2. The use of tweezers or vacuum pick up is strongly recommended for individual components.
 3. Bulk handling should ensure that abrasion and mechanical shock are minimized.

測試報告

Test Report

號碼(No.) : CE/2018/34305 日期(Date) : 2018/03/22

頁數(Page): 1 of 14

西北臺慶科技股份有限公司 / TAI-TECH ADVANCED ELECTRONICS CO., LTD.

(臺慶精密電子(昆山)有限公司 / TAI-TECH ADVANCED ELECTRONICS (KUN-SHAN) CO. LTD.)

(慶邦電子元器件(泗洪)有限公司 / TAIPAQ ELECTRONICS (SI-HONG) CO., LTD.)

桃園市楊梅區幼獅工業區幼四路1號 / NO. 1, YOU 4TH ROAD, YOUTH INDUSTRIAL DISTRICT, YANG-MEI, TAO-YUAN CITY, TAIWAN, R. O. C.

(江蘇省昆山市蓬朗昆嘉高科技工業區郭澤路 / GUO-ZE ROAD, KUNJIA HI-TECH INDUSTRIAL PARK, KUN-SHAN, JIANG-SU, CHINA)

(中國, 江蘇省, 宿遷市, 泗洪縣, 經濟開發區杭州路南側, 建設北路東側 / THE SOUTH HANGZHOU ROAD AND THE EAST JIANSHE ROAD, ECONOMIC DEVELOPMENT ZONE, SIHONG COUNTY, SUQIANCITY, JIANGSU PROVINCE, P, R, CHINA)



以下測試樣品係由申請廠商所提供及確認 (The following sample(s) was/were submitted and identified by/on behalf of the applicant as):

樣品名稱(Sample Description) : WIREWOUND SERIES
樣品型號(Style/Item No.) : WCM、WCL、HSF、HDMI、DVI、BCM、PCM、TCM、LCM、LPF、TXF、ACM、DCM、WIH、BPH、TNH、YCM、STF SERIES
收件日期(Sample Receiving Date) : 2018/03/15
測試期間(Testing Period) : 2018/03/15 TO 2018/03/22

=====
測試結果(Test Results) : 請參閱下一頁 (Please refer to following pages).

Troy Chang, Manager - Tech
Signed for and on behalf of
SGS TAIWAN LTD.
Chemical Laboratory - Taipei



This document is issued by the Company subject to its General Conditions of Service printed overleaf, available on request or accessible at <http://www.sgs.com/en/Terms-and-Conditions.aspx> and, for electronic format documents, subject to Terms and Conditions for Electronic Documents at <http://www.sgs.com/en/Terms-and-Conditions/terms-e-document.aspx>. Attention is drawn to the limitation of liability, indemnification and jurisdiction issues defined therein. Any holder of this document is advised that information contained hereon reflects the Company's findings at the time of its intervention only and within the limits of client's instruction, if any. The Company's sole responsibility is to its Client and this document does not exonerate parties to a transaction from exercising all their rights and obligations under the transaction documents. This document cannot be reproduced, except in full, without prior written approval of the Company. Any unauthorized alteration, forgery or falsification of the content or appearance of this document is unlawful and offenders may be prosecuted to the fullest extent of the law. Unless otherwise stated the results shown in this test report refer only to the sample(s) tested.



測試報告

Test Report

號碼(No.) : CE/2018/34305 日期(Date) : 2018/03/22

頁數(Page): 2 of 14

西北臺慶科技股份有限公司 / TAI-TECH ADVANCED ELECTRONICS CO., LTD.

(臺慶精密電子(昆山)有限公司 / TAI-TECH ADVANCED ELECTRONICS (KUN-SHAN) CO. LTD.)

(慶邦電子元器件(泗洪)有限公司 / TAIPAQ ELECTRONICS (SI-HONG) CO., LTD.)

桃園市楊梅區幼獅工業區幼四路1號 / NO. 1, YOU 4TH ROAD, YOUTH INDUSTRIAL DISTRICT, YANG-MEI, TAO-YUAN CITY, TAIWAN, R. O. C.

(江蘇省昆山市蓬朗昆嘉高科技工業區郭澤路 / GUO-ZE ROAD, KUNJIA HI-TECH INDUSTRIAL PARK, KUN-SHAN, JIANG-SU, CHINA)

(中國, 江蘇省, 宿遷市, 泗洪縣, 經濟開發區杭州路南側, 建設北路東側 / THE SOUTH HANGZHOU ROAD AND THE EAST JIANSHE ROAD, ECONOMIC DEVELOPMENT ZONE, SIHONG COUNTY, SUQIANCITY, JIANGSU PROVINCE, P, R, CHINA)



測試結果(Test Results)

測試部位(PART NAME)No. 1 : 整體混測 (MIXED ALL PARTS)

| 測試項目 (Test Items) | 單位 (Unit) | 測試方法 (Method) | 方法偵測 極限值 (MDL) | 結果 (Result) |
|----------------------------------|--------------|--|----------------------|----------------|
| | | | | No. 1 |
| 鎘 / Cadmium (Cd) | mg/kg | 參考IEC 62321-5 (2013), 以感應耦合電漿原子發射光譜儀檢測. / With reference to IEC 62321-5 (2013) and performed by ICP-AES. | 2 | n. d. |
| 鉛 / Lead (Pb) | mg/kg | | 2 | n. d. |
| 汞 / Mercury (Hg) | mg/kg | | 2 | n. d. |
| 六價鉻 / Hexavalent Chromium Cr(VI) | mg/kg | 參考IEC 62321-7-2 (2017), 以UV-VIS 檢測. / With reference to IEC 62321-7-2 (2017) and performed by UV-VIS. | 8 | n. d. |
| 多溴聯苯總和 / Sum of PBBs | mg/kg | 參考IEC 62321-6 (2015), 以氣相層析/質譜儀檢測. / With reference to IEC 62321-6 (2015) and performed by GC/MS. | - | n. d. |
| 一溴聯苯 / Monobromobiphenyl | mg/kg | | 5 | n. d. |
| 二溴聯苯 / Dibromobiphenyl | mg/kg | | 5 | n. d. |
| 三溴聯苯 / Tribromobiphenyl | mg/kg | | 5 | n. d. |
| 四溴聯苯 / Tetrabromobiphenyl | mg/kg | | 5 | n. d. |
| 五溴聯苯 / Pentabromobiphenyl | mg/kg | | 5 | n. d. |
| 六溴聯苯 / Hexabromobiphenyl | mg/kg | | 5 | n. d. |
| 七溴聯苯 / Heptabromobiphenyl | mg/kg | | 5 | n. d. |
| 八溴聯苯 / Octabromobiphenyl | mg/kg | | 5 | n. d. |
| 九溴聯苯 / Nonabromobiphenyl | mg/kg | | 5 | n. d. |
| 十溴聯苯 / Decabromobiphenyl | mg/kg | 5 | n. d. | |

This document is issued by the Company subject to its General Conditions of Service printed overleaf, available on request or accessible at <http://www.sgs.com.tw/Terms-and-Conditions.aspx> and, for electronic format documents, subject to Terms and Conditions for Electronic Documents at <http://www.sgs.com.tw/Terms-and-Conditions/Electronic-Documents.aspx>. Attention is drawn to the limitation of liability, indemnification and jurisdiction issues defined therein. Any holder of this document is advised that information contained hereon reflects the Company's findings at the time of its intervention only and within the limits of client's instruction, if any. The Company's sole responsibility is to its Client and this document does not exonerate parties to a transaction from exercising all their rights and obligations under the transaction documents. This document cannot be reproduced, except in full, without prior written approval of the Company. Any unauthorized alteration, forgery or falsification of the content or appearance of this document is unlawful and offenders may be prosecuted to the fullest extent of the law. Unless otherwise stated the results shown in this test report refer only to the sample(s) tested.

測試報告

Test Report

號碼(No.) : CE/2018/34305

日期(Date) : 2018/03/22

頁數(Page): 3 of 14

西北臺慶科技股份有限公司 / TAI-TECH ADVANCED ELECTRONICS CO., LTD.

(臺慶精密電子(昆山)有限公司 / TAI-TECH ADVANCED ELECTRONICS (KUN-SHAN) CO. LTD.)

(慶邦電子元器件(泗洪)有限公司 / TAIPAQ ELECTRONICS (SI-HONG) CO., LTD.)

桃園市楊梅區幼獅工業區幼四路1號 / NO. 1, YOU 4TH ROAD, YOUTH INDUSTRIAL DISTRICT, YANG-MEI, TAO-YUAN CITY, TAIWAN, R. O. C.

(江蘇省昆山市蓬朗昆嘉高科技工業區郭澤路 / GUO-ZE ROAD, KUNJIA HI-TECH INDUSTRIAL PARK, KUN-SHAN, JIANG-SU, CHINA)

(中國, 江蘇省, 宿遷市, 泗洪縣, 經濟開發區杭州路南側, 建設北路東側 / THE SOUTH HANGZHOU ROAD AND THE EAST JIANSHE ROAD, ECONOMIC DEVELOPMENT ZONE, SIHONG COUNTY, SUQIANCITY, JIANGSU PROVINCE, P, R, CHINA)



| 測試項目 (Test Items) | 單位 (Unit) | 測試方法 (Method) | 方法偵測 極限值 (MDL) | 結果 (Result) |
|--|--------------|---|----------------------|----------------|
| | | | | No. 1 |
| 多溴聯苯醚總和 / Sum of PBDEs | mg/kg | 參考IEC 62321-6 (2015), 以氣相層析/質譜儀檢測. / With reference to IEC 62321-6 (2015) and performed by GC/MS. | - | n. d. |
| 一溴聯苯醚 / Monobromodiphenyl ether | mg/kg | | 5 | n. d. |
| 二溴聯苯醚 / Dibromodiphenyl ether | mg/kg | | 5 | n. d. |
| 三溴聯苯醚 / Tribromodiphenyl ether | mg/kg | | 5 | n. d. |
| 四溴聯苯醚 / Tetrabromodiphenyl ether | mg/kg | | 5 | n. d. |
| 五溴聯苯醚 / Pentabromodiphenyl ether | mg/kg | | 5 | n. d. |
| 六溴聯苯醚 / Hexabromodiphenyl ether | mg/kg | | 5 | n. d. |
| 七溴聯苯醚 / Heptabromodiphenyl ether | mg/kg | | 5 | n. d. |
| 八溴聯苯醚 / Octabromodiphenyl ether | mg/kg | | 5 | n. d. |
| 九溴聯苯醚 / Nonabromodiphenyl ether | mg/kg | | 5 | n. d. |
| 十溴聯苯醚 / Decabromodiphenyl ether | mg/kg | 5 | n. d. | |
| 六溴環十二烷及所有主要被辨別出的異構物 / Hexabromocyclododecane (HBCDD) and all major diastereoisomers identified (α -HBCDD, β -HBCDD, γ -HBCDD) (CAS No.: 25637-99-4 and 3194-55-6 (134237-51-7, 134237-50-6, 134237-52-8)) | mg/kg | 參考IEC 62321 (2008), 以氣相層析/質譜儀檢測. / With reference to IEC 62321 (2008). Analysis was performed by GC/MS. | 5 | n. d. |
| 鹵素 / Halogen | | | | |
| 鹵素(氟) / Halogen-Fluorine (F) (CAS No.: 14762-94-8) | mg/kg | 參考BS EN 14582 (2016), 以離子層析儀分析. / With reference to BS EN 14582 (2016). Analysis was performed by IC. | 50 | n. d. |
| 鹵素(氯) / Halogen-Chlorine (Cl) (CAS No.: 22537-15-1) | mg/kg | | 50 | n. d. |
| 鹵素(溴) / Halogen-Bromine (Br) (CAS No.: 10097-32-2) | mg/kg | | 50 | n. d. |
| 鹵素(碘) / Halogen-Iodine (I) (CAS No.: 14362-44-8) | mg/kg | | 50 | n. d. |

This document is issued by the Company subject to its General Conditions of Service printed overleaf, available on request or accessible at <http://www.sgs.com/en/Terms-and-Conditions.aspx> and, for electronic format documents, subject to Terms and Conditions for Electronic Documents at <http://www.sgs.com/en/Terms-and-Conditions.aspx>. Attention is drawn to the limitation of liability, indemnification and jurisdiction issues defined therein. Any holder of this document is advised that information contained hereon reflects the Company's findings at the time of its intervention only and within the limits of client's instruction, if any. The Company's sole responsibility is to its Client and this document does not exonerate parties to a transaction from exercising all their rights and obligations under the transaction documents. This document cannot be reproduced, except in full, without prior written approval of the Company. Any unauthorized alteration, forgery or falsification of the content or appearance of this document is unlawful and offenders may be prosecuted to the fullest extent of the law. Unless otherwise stated the results shown in this test report refer only to the sample(s) tested.



測試報告

Test Report

號碼(No.) : CE/2018/34305

日期(Date) : 2018/03/22

頁數(Page): 4 of 14

西北臺慶科技股份有限公司 / TAI-TECH ADVANCED ELECTRONICS CO., LTD.

(臺慶精密電子(昆山)有限公司 / TAI-TECH ADVANCED ELECTRONICS (KUN-SHAN) CO. LTD.)

(慶邦電子元器件(泗洪)有限公司 / TAIPAQ ELECTRONICS (SI-HONG) CO., LTD.)

桃園市楊梅區幼獅工業區幼四路1號 / NO. 1, YOU 4TH ROAD, YOUTH INDUSTRIAL DISTRICT, YANG-MEI, TAO-YUAN CITY, TAIWAN, R. O. C.

(江蘇省昆山市蓬朗昆嘉高科技工業區郭澤路 / GUO-ZE ROAD, KUNJIA HI-TECH INDUSTRIAL PARK, KUN-SHAN, JIANG-SU, CHINA)

(中國, 江蘇省, 宿遷市, 泗洪縣, 經濟開發區杭州路南側, 建設北路東側 / THE SOUTH HANGZHOU ROAD AND THE EAST JIANSHE ROAD, ECONOMIC DEVELOPMENT ZONE, SIHONG COUNTY, SUQIANCITY, JIANGSU PROVINCE, P, R, CHINA)



| 測試項目 (Test Items) | 單位 (Unit) | 測試方法 (Method) | 方法偵測 極限值 (MDL) | 結果 (Result) |
|---|--------------|--|----------------------|----------------|
| | | | | No. 1 |
| 鄰苯二甲酸丁苯甲酯 / BBP (Butyl Benzyl phthalate) (CAS No. : 85-68-7) | mg/kg | 參考IEC 62321-8 (2017), 以氣相層析儀/質譜儀檢測. / With reference to IEC 62321-8 (2017). Analysis was performed by GC/MS. | 50 | n. d. |
| 鄰苯二甲酸二丁酯 / DBP (Dibutyl phthalate) (CAS No. : 84-74-2) | mg/kg | | 50 | n. d. |
| 鄰苯二甲酸二(2-乙基己基)酯 / DEHP (Di-(2-ethylhexyl) phthalate) (CAS No. : 117-81-7) | mg/kg | | 50 | n. d. |
| 鄰苯二甲酸二異丁酯 / DIBP (Di-isobutyl phthalate) (CAS No. : 84-69-5) | mg/kg | | 50 | n. d. |
| 鄰苯二甲酸二異癸酯 / DIDP (Di-isodecyl phthalate) (CAS No. : 26761-40-0; 68515-49-1) | mg/kg | | 50 | n. d. |
| 鄰苯二甲酸二異壬酯 / DINP (Di-isononyl phthalate) (CAS No. : 28553-12-0; 68515-48-0) | mg/kg | | 50 | n. d. |
| 鄰苯二甲酸二正辛酯 / DNOP (Di-n-octyl phthalate) (CAS No. : 117-84-0) | mg/kg | | 50 | n. d. |
| 鄰苯二甲酸二正己酯 / DNHP (Di-n-hexyl phthalate) (CAS No. : 84-75-3) | mg/kg | | 50 | n. d. |
| 鄰苯二甲酸二戊酯 / DNPP (Di-n-pentyl phthalate) (CAS No. : 131-18-0) | mg/kg | | 50 | n. d. |
| 銻 / Antimony (Sb) | mg/kg | 參考US EPA 3052 (1996), 以感應耦合電漿原子發射光譜儀檢測. / With reference to US EPA 3052 (1996). Analysis was performed by ICP-AES. | 2 | n. d. |
| 鈹 / Beryllium (Be) | mg/kg | | 2 | n. d. |

This document is issued by the Company subject to its General Conditions of Service printed overleaf, available on request or accessible at <http://www.sgs.com.tw/Terms-and-Conditions.aspx> and, for electronic format documents, subject to Terms and Conditions for Electronic Documents at <http://www.sgs.com.tw/Terms-and-Conditions/Electronic-Documents.aspx>. Attention is drawn to the limitation of liability, indemnification and jurisdiction issues defined therein. Any holder of this document is advised that information contained hereon reflects the Company's findings at the time of its intervention only and within the limits of client's instruction, if any. The Company's sole responsibility is to its Client and this document does not exonerate parties to a transaction from exercising all their rights and obligations under the transaction documents. This document cannot be reproduced, except in full, without prior written approval of the Company. Any unauthorized alteration, forgery or falsification of the content or appearance of this document is unlawful and offenders may be prosecuted to the fullest extent of the law. Unless otherwise stated the results shown in this test report refer only to the sample(s) tested.



測試報告

Test Report

號碼(No.) : CE/2018/34305

日期(Date) : 2018/03/22

頁數(Page): 5 of 14

西北臺慶科技股份有限公司 / TAI-TECH ADVANCED ELECTRONICS CO., LTD.

(臺慶精密電子(昆山)有限公司 / TAI-TECH ADVANCED ELECTRONICS (KUN-SHAN) CO. LTD.)

(慶邦電子元器件(泗洪)有限公司 / TAIPAQ ELECTRONICS (SI-HONG) CO., LTD.)

桃園市楊梅區幼獅工業區幼四路1號 / NO. 1, YOU 4TH ROAD, YOUTH INDUSTRIAL DISTRICT, YANG-MEI, TAO-YUAN CITY, TAIWAN, R. O. C.

(江蘇省昆山市蓬朗昆嘉高科技工業區郭澤路 / GUO-ZE ROAD, KUNJIA HI-TECH INDUSTRIAL PARK, KUN-SHAN, JIANG-SU, CHINA)

(中國, 江蘇省, 宿遷市, 泗洪縣, 經濟開發區杭州路南側, 建設北路東側 / THE SOUTH HANGZHOU ROAD AND THE EAST JIANSHE ROAD, ECONOMIC DEVELOPMENT ZONE, SIHONG COUNTY, SUQIANCITY, JIANGSU PROVINCE, P, R, CHINA)



| 測試項目 (Test Items) | 單位 (Unit) | 測試方法 (Method) | 方法偵測 極限值 (MDL) | 結果 (Result) |
|--|--------------|---|----------------------|----------------|
| | | | | No. 1 |
| 全氟辛烷磺酸 / Perfluorooctane sulfonates (PFOS-Acid, Metal Salt, Amide) | mg/kg | 參考US EPA 3550C (2007), 以液相層析/質譜儀檢測. / With reference to US EPA 3550C (2007). Analysis was performed by LC/MS. | 10 | n. d. |
| 全氟辛酸 / PFOA (CAS No. : 335-67-1) | mg/kg | | 10 | n. d. |
| 聚氯乙烷 / PVC | ** | 以紅外光譜分析及焰色法檢測. / Analysis was performed by FTIR and FLAME Test. | - | Negative |

備註(Note) :

1. mg/kg = ppm ; 0.1wt% = 1000ppm
2. n. d. = Not Detected (未檢出)
3. MDL = Method Detection Limit (方法偵測極限值)
4. "-" = Not Regulated (無規格值)
5. **= Qualitative analysis (No Unit) 定性分析(無單位)
6. Negative = Undetectable 陰性(未偵測到); Positive = Detectable 陽性(已偵測到)
7. 樣品的測試是基於申請人要求混合測試, 報告中的混合測試結果不代表其中個別單一材質的含量. (The samples was/were analyzed on behalf of the applicant as mixing sample in one testing. The above results was/were only given as the informality value.)

PFOS參考資訊(Reference Information) : 持久性有機污染物 POPs - (EU) 757/2010

PFOS濃度在物質或製備中不得超過0.001%(10ppm), 在半成品、成品或零部件中不得超過0.1%(1000ppm), 在紡織品或塗層材料中不得超過1µg/m²。

(Outlawing PFOS as substances or preparations in concentrations above 0.001% (10ppm), in semi-finished products or articles or parts at a level above 0.1%(1000ppm), in textiles or other coated materials above 1µg/m².)

This document is issued by the Company subject to its General Conditions of Service printed overleaf, available on request or accessible at <http://www.sgs.com/en/Service/Terms-and-Conditions.aspx> and, for electronic format documents, subject to Terms and Conditions for Electronic Documents at <http://www.sgs.com/en/Service/Terms-and-Conditions/Service-Documents.aspx>. Attention is drawn to the limitation of liability, indemnification and jurisdiction issues defined therein. Any holder of this document is advised that information contained hereon reflects the Company's findings at the time of its intervention only and within the limits of client's instruction, if any. The Company's sole responsibility is to its Client and this document does not exonerate parties to a transaction from exercising all their rights and obligations under the transaction documents. This document cannot be reproduced, except in full, without prior written approval of the Company. Any unauthorized alteration, forgery or falsification of the content or appearance of this document is unlawful and offenders may be prosecuted to the fullest extent of the law. Unless otherwise stated the results shown in this test report refer only to the sample(s) tested.

測試報告 Test Report

號碼(No.) : CE/2018/34305

日期(Date) : 2018/03/22

頁數(Page): 6 of 14



西北臺慶科技股份有限公司 / TAI-TECH ADVANCED ELECTRONICS CO., LTD.

(臺慶精密電子(昆山)有限公司 / TAI-TECH ADVANCED ELECTRONICS (KUN-SHAN) CO. LTD.)

(慶邦電子元器件(泗洪)有限公司 / TAIPAQ ELECTRONICS (SI-HONG) CO., LTD.)

桃園市楊梅區幼獅工業區幼四路1號 / NO. 1, YOU 4TH ROAD, YOUTH INDUSTRIAL DISTRICT, YANG-MEI, TAO-YUAN CITY, TAIWAN, R. O. C.

(江蘇省昆山市蓬朗昂嘉高科技工業區郭澤路 / GUO-ZE ROAD, KUNJIA HI-TECH INDUSTRIAL PARK, KUN-SHAN, JIANG-SU, CHINA)

(中國, 江蘇省, 宿遷市, 泗洪縣, 經濟開發區杭州路南側, 建設北路東側 / THE SOUTH HANGZHOU ROAD AND THE EAST JIANSHE ROAD, ECONOMIC DEVELOPMENT ZONE, SIHONG COUNTY, SUQIANCITY, JIANGSU PROVINCE, P, R, CHINA)

重金屬流程圖 / Analytical flow chart of Heavy Metal

根據以下的流程圖之條件, 樣品已完全溶解。(六價鉻測試方法除外)

These samples were dissolved totally by pre-conditioning method according to below flow chart. (Cr⁶⁺ test method excluded)

- 測試人員: 王志瑋 / Technician: JR Wang
- 測試負責人: 張啟興 / Supervisor: Troy Chang

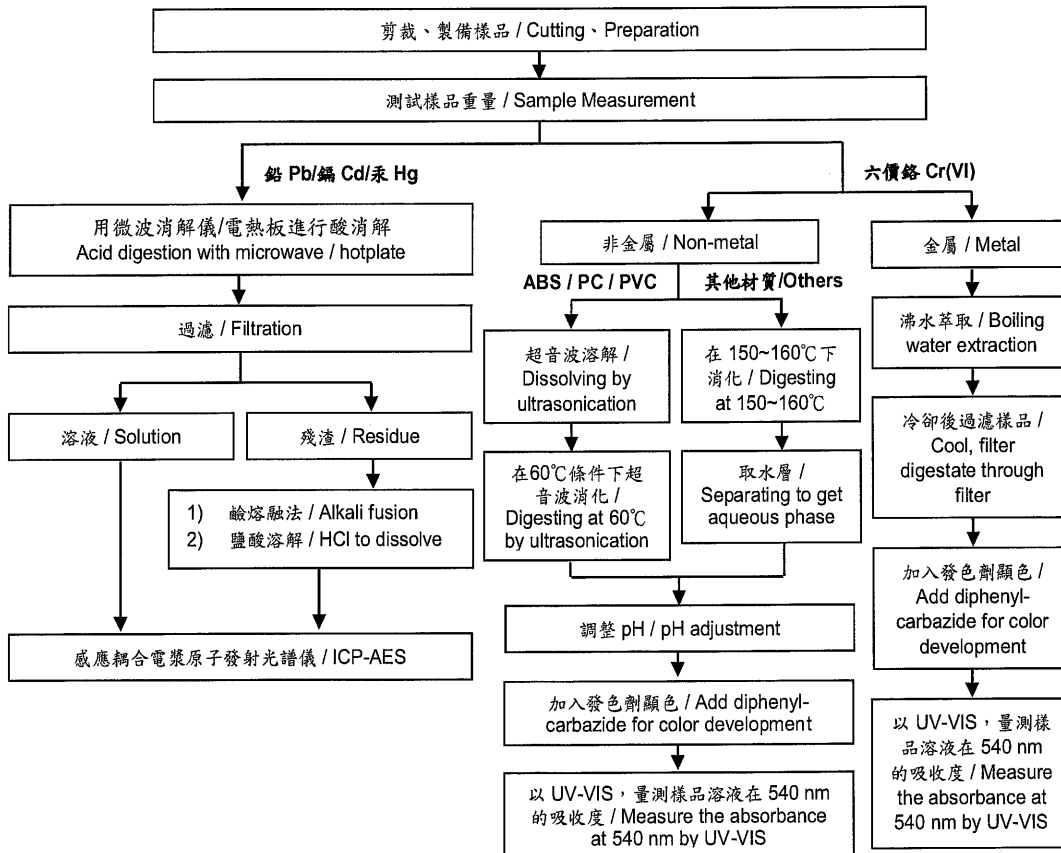

This document is issued by the Company subject to its General Conditions of Service printed overleaf, available on request or accessible at <http://www.sgs.com.tw/Terms-and-Conditions.aspx> and, for electronic format documents, subject to Terms and Conditions for Electronic Documents at <http://www.sgs.com.tw/Terms-and-Conditions/ETerms-Document.aspx>. Attention is drawn to the limitation of liability, indemnification and jurisdiction issues defined therein. Any holder of this document is advised that information contained hereon reflects the Company's findings at the time of its intervention only and within the limits of client's instruction, if any. The Company's sole responsibility is to its Client and this document does not exonerate parties to a transaction from exercising all their rights and obligations under the transaction documents. This document cannot be reproduced, except in full, without prior written approval of the Company. Any unauthorized alteration, forgery or falsification of the content or appearance of this document is unlawful and offenders may be prosecuted to the fullest extent of the law. Unless otherwise stated the results shown in this test report refer only to the sample(s) tested.

測試報告

Test Report

號碼(No.) : CE/2018/34305

日期(Date) : 2018/03/22

頁數(Page): 7 of 14

西北臺慶科技股份有限公司 / TAI-TECH ADVANCED ELECTRONICS CO., LTD.

(臺慶精密電子(昆山)有限公司 / TAI-TECH ADVANCED ELECTRONICS (KUN-SHAN) CO. LTD.)

(慶邦電子元器件(泗洪)有限公司 / TAIPAQ ELECTRONICS (SI-HONG) CO., LTD.)

桃園市楊梅區幼獅工業區幼四路1號 / NO. 1, YOU 4TH ROAD, YOUTH INDUSTRIAL DISTRICT, YANG-MEI, TAO-YUAN CITY, TAIWAN, R. O. C.

(江蘇省昆山市蓬朗昆嘉高科技工業區郭澤路 / GUO-ZE ROAD, KUNJIA HI-TECH INDUSTRIAL PARK, KUN-SHAN, JIANG-SU, CHINA)

(中國, 江蘇省, 宿遷市, 泗洪縣, 經濟開發區杭州路南側, 建設北路東側 / THE SOUTH HANGZHOU ROAD AND THE EAST JIANSHE ROAD, ECONOMIC DEVELOPMENT ZONE, SIHONG COUNTY, SUQIANCITY, JIANGSU PROVINCE, P, R, CHINA)



多溴聯苯/多溴聯苯醚分析流程圖 / Analytical flow chart - PBB/PBDE

- 測試人員: 涂雅苓 / Technician: Yaling Tu
- 測試負責人: 張啟興 / Supervisor: Troy Chang

初次測試程序 / First testing process ———→

選擇性篩檢程序 / Optional screen process→

確認程序 / Confirmation process - - - ->

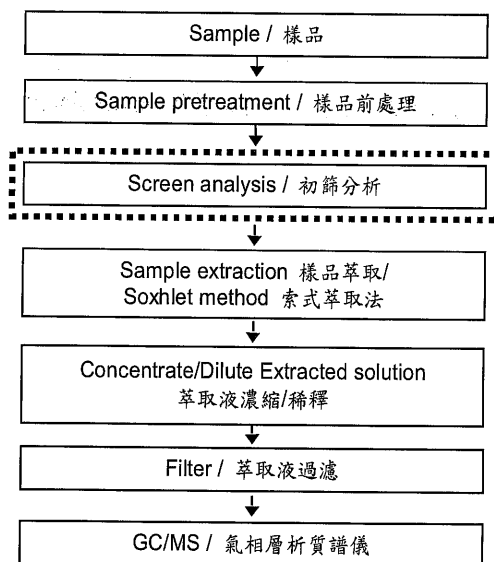

This document is issued by the Company subject to its General Conditions of Service printed overleaf, available on request or accessible at http://www.sgs.com.tw/Terms_and_Conditions.aspx and, for electronic format documents, subject to Terms and Conditions for Electronic Documents at http://www.sgs.com.tw/terms_and_conditions/terms_document.aspx. Attention is drawn to the limitation of liability, indemnification and jurisdiction issues defined therein. Any holder of this document is advised that information contained hereon reflects the Company's findings at the time of its intervention only and within the limits of client's instruction, if any. The Company's sole responsibility is to its Client and this document does not exonerate parties to a transaction from exercising all their rights and obligations under the transaction documents. This document cannot be reproduced, except in full, without prior written approval of the Company. Any unauthorized alteration, forgery or falsification of the content or appearance of this document is unlawful and offenders may be prosecuted to the fullest extent of the law. Unless otherwise stated the results shown in this test report refer only to the sample(s) tested.

測試報告

Test Report

號碼(No.) : CE/2018/34305 日期(Date) : 2018/03/22

頁數(Page): 8 of 14

西北臺慶科技股份有限公司 / TAI-TECH ADVANCED ELECTRONICS CO., LTD.

(臺慶精密電子(昆山)有限公司 / TAI-TECH ADVANCED ELECTRONICS (KUN-SHAN) CO. LTD.)

(慶邦電子元器件(泗洪)有限公司 / TAIPAQ ELECTRONICS (SI-HONG) CO., LTD.)

桃園市楊梅區幼獅工業區幼四路1號 / NO. 1, YOU 4TH ROAD, YOUTH INDUSTRIAL DISTRICT, YANG-MEI, TAO-YUAN CITY, TAIWAN, R. O. C.

(江蘇省昆山市蓬朗昆嘉高科技工業區郭澤路 / GUO-ZE ROAD, KUNJIA HI-TECH INDUSTRIAL PARK, KUN-SHAN, JIANG-SU, CHINA)

(中國, 江蘇省, 宿遷市, 泗洪縣, 經濟開發區杭州路南側, 建設北路東側 / THE SOUTH HANGZHOU ROAD AND THE EAST JIANSHE ROAD, ECONOMIC DEVELOPMENT ZONE, SIHONG COUNTY, SUQIANCITY, JIANGSU PROVINCE, P, R, CHINA)



可塑劑分析流程圖 / Analytical flow chart - Phthalate

- 測試人員：徐毓明 / Technician: Andy Hsu
- 測試負責人：張啟興 / Supervisor : Troy Chang

【測試方法/Test method: IEC 62321-8】

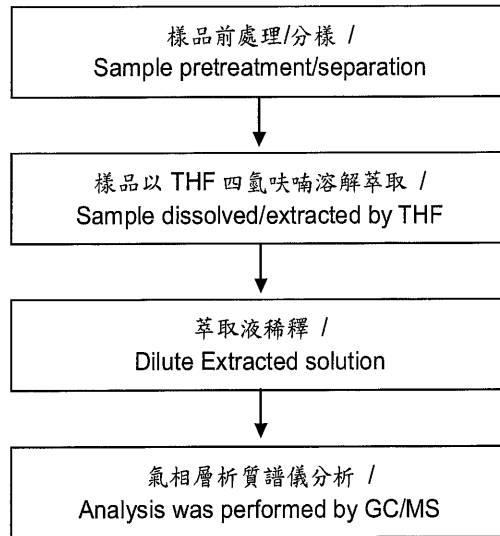

This document is issued by the Company subject to its General Conditions of Service printed overleaf, available on request or accessible at <http://www.sgs.com/en/Terms-and-Conditions.aspx> and, for electronic format documents, subject to Terms and Conditions for Electronic Documents at <http://www.sgs.com/en/Terms-and-Conditions/Terms-and-Conditions-Document.aspx>. Attention is drawn to the limitation of liability, indemnification and jurisdiction issues defined therein. Any holder of this document is advised that information contained hereon reflects the Company's findings at the time of its intervention only and within the limits of client's instruction, if any. The Company's sole responsibility is to its Client and this document does not exonerate parties to a transaction from exercising all their rights and obligations under the transaction documents. This document cannot be reproduced, except in full, without prior written approval of the Company. Any unauthorized alteration, forgery or falsification of the content or appearance of this document is unlawful and offenders may be prosecuted to the fullest extent of the law. Unless otherwise stated the results shown in this test report refer only to the sample(s) tested.

測試報告

Test Report

號碼(No.) : CE/2018/34305 日期(Date) : 2018/03/22

頁數(Page): 9 of 14

西北臺慶科技股份有限公司 / TAI-TECH ADVANCED ELECTRONICS CO., LTD.

(臺慶精密電子(昆山)有限公司 / TAI-TECH ADVANCED ELECTRONICS (KUN-SHAN) CO. LTD.)

(慶邦電子元器件(泗洪)有限公司 / TAIPAQ ELECTRONICS (SI-HONG) CO., LTD.)

桃園市楊梅區幼獅工業區幼四路1號 / NO. 1, YOU 4TH ROAD, YOUTH INDUSTRIAL DISTRICT, YANG-MEI, TAO-YUAN CITY, TAIWAN, R. O. C.

(江蘇省昆山市蓬朗昆嘉高科技工業區郭澤路 / GUO-ZE ROAD, KUNJIA HI-TECH INDUSTRIAL PARK, KUN-SHAN, JIANG-SU, CHINA)

(中國, 江蘇省, 宿遷市, 泗洪縣, 經濟開發區杭州路南側, 建設北路東側 / THE SOUTH HANGZHOU ROAD AND THE EAST JIANSHE ROAD, ECONOMIC DEVELOPMENT ZONE, SIHONG COUNTY, SUQIANCITY, JIANGSU PROVINCE, P, R, CHINA)



六溴環十二烷分析流程圖 / Analytical flow chart - HBCDD

- 測試人員：涂雅苓 / Technician: Yaling Tu
- 測試負責人：張啟興 / Supervisor: Troy Chang

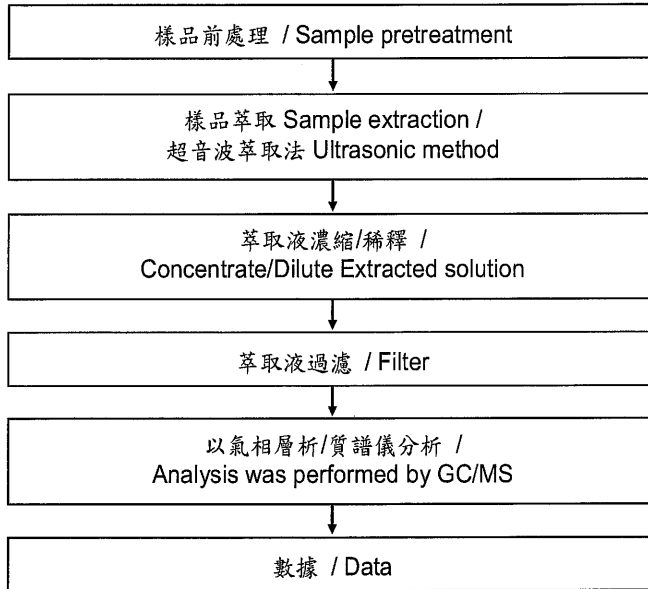

This document is issued by the Company subject to its General Conditions of Service printed overleaf, available on request or accessible at <http://www.sgs.com.tw/Terms-and-Conditions.aspx> and, for electronic format documents, subject to Terms and Conditions for Electronic Documents at <http://www.sgs.com.tw/Terms-and-Conditions/Terms-Documents.aspx>. Attention is drawn to the limitation of liability, indemnification and jurisdiction issues defined therein. Any holder of this document is advised that information contained hereon reflects the Company's findings at the time of its intervention only and within the limits of client's instruction, if any. The Company's sole responsibility is to its Client and this document does not exonerate parties to a transaction from exercising all their rights and obligations under the transaction documents. This document cannot be reproduced, except in full, without prior written approval of the Company. Any unauthorized alteration, forgery or falsification of the content or appearance of this document is unlawful and offenders may be prosecuted to the fullest extent of the law. Unless otherwise stated the results shown in this test report refer only to the sample(s) tested.

測試報告 Test Report

號碼(No.) : CE/2018/34305

日期(Date) : 2018/03/22

頁數(Page): 10 of 14

西北臺慶科技股份有限公司 / TAI-TECH ADVANCED ELECTRONICS CO., LTD.

(臺慶精密電子(昆山)有限公司 / TAI-TECH ADVANCED ELECTRONICS (KUN-SHAN) CO. LTD.)

(慶邦電子元器件(泗洪)有限公司 / TAIPAQ ELECTRONICS (SI-HONG) CO., LTD.)

桃園市楊梅區幼獅工業區幼四路1號 / NO. 1, YOU 4TH ROAD, YOUTH INDUSTRIAL DISTRICT, YANG-MEI, TAO-YUAN CITY, TAIWAN, R. O. C.

(江蘇省昆山市蓬朗昆嘉高科技工業區郭澤路 / GUO-ZE ROAD, KUNJIA HI-TECH INDUSTRIAL PARK, KUN-SHAN, JIANG-SU, CHINA)

(中國, 江蘇省, 宿遷市, 泗洪縣, 經濟開發區杭州路南側, 建設北路東側 / THE SOUTH HANGZHOU ROAD AND THE EAST JIANSHE ROAD, ECONOMIC DEVELOPMENT ZONE, SIHONG COUNTY, SUQIANCITY, JIANGSU PROVINCE, P, R, CHINA)



鹵素分析流程圖 / Analytical flow chart - Halogen

- 測試人員: 陳思臻 / Technician: Rita Chen
- 測試負責人: 張啟興 / Supervisor: Troy Chang

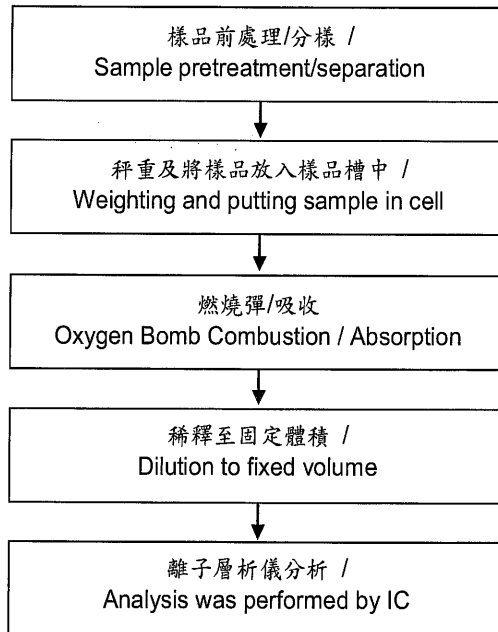

This document is issued by the Company subject to its General Conditions of Service printed overleaf, available on request or accessible at http://www.sgs.com.tw/Terms_and_Conditions.asp, and, for electronic format documents, subject to Terms and Conditions for Electronic Documents at http://www.sgs.com.tw/Terms_and_Conditions/Electronic_Document.asp. Attention is drawn to the limitation of liability, indemnification and jurisdiction issues defined therein. Any holder of this document is advised that information contained hereon reflects the Company's findings at the time of its intervention only and within the limits of client's instruction, if any. The Company's sole responsibility is to its Client and this document does not exonerate parties to a transaction from exercising all their rights and obligations under the transaction documents. This document cannot be reproduced, except in full, without prior written approval of the Company. Any unauthorized alteration, forgery or falsification of the content or appearance of this document is unlawful and offenders may be prosecuted to the fullest extent of the law. Unless otherwise stated the results shown in this test report refer only to the sample(s) tested.



測試報告

Test Report

號碼(No.) : CE/2018/34305

日期(Date) : 2018/03/22

頁數(Page): 11 of 14

西北臺慶科技股份有限公司 / TAI-TECH ADVANCED ELECTRONICS CO., LTD.

(臺慶精密電子(昆山)有限公司 / TAI-TECH ADVANCED ELECTRONICS (KUN-SHAN) CO. LTD.)

(慶邦電子元器件(泗洪)有限公司 / TAIPAQ ELECTRONICS (SI-HONG) CO., LTD.)

桃園市楊梅區幼獅工業區幼四路1號 / NO. 1, YOU 4TH ROAD, YOUTH INDUSTRIAL DISTRICT, YANG-MEI, TAO-YUAN CITY, TAIWAN, R. O. C.

(江蘇省昆山市蓬朗昆嘉高科技工業區郭澤路 / GUO-ZE ROAD, KUNJIA HI-TECH INDUSTRIAL PARK, KUN-SHAN, JIANG-SU, CHINA)

(中國, 江蘇省, 宿遷市, 泗洪縣, 經濟開發區杭州路南側, 建設北路東側 / THE SOUTH HANGZHOU ROAD AND THE EAST JIANSHE ROAD, ECONOMIC DEVELOPMENT ZONE, SIHONG COUNTY, SUQIANCITY, JIANGSU PROVINCE, P, R, CHINA)



全氟辛酸/全氟辛烷磺酸分析流程圖 / Analytical flow chart - PFOA/PFOS

- 測試人員：涂雅苓 / Technician: Yaling Tu
- 測試負責人：張啟興 / Supervisor: Troy Chang

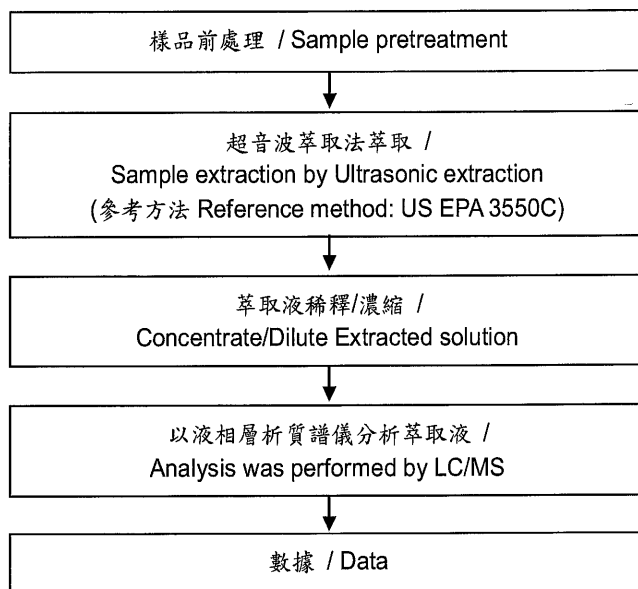

This document is issued by the Company subject to its General Conditions of Service printed overleaf, available on request or accessible at http://www.sgs.com.tw/Terms_and_Conditions.aspx and, for electronic format documents, subject to Terms and Conditions for Electronic Documents at http://www.sgs.com.tw/Terms_and_Conditions/English_Document.aspx. Attention is drawn to the limitation of liability, indemnification and jurisdiction issues defined therein. Any holder of this document is advised that information contained hereon reflects the Company's findings at the time of its intervention only and within the limits of client's instruction, if any. The Company's sole responsibility is to its Client and this document does not exonerate parties to a transaction from exercising all their rights and obligations under the transaction documents. This document cannot be reproduced, except in full, without prior written approval of the Company. Any unauthorized alteration, forgery or falsification of the content or appearance of this document is unlawful and offenders may be prosecuted to the fullest extent of the law. Unless otherwise stated the results shown in this test report refer only to the sample(s) tested.

測試報告

Test Report

號碼(No.) : CE/2018/34305

日期(Date) : 2018/03/22

頁數(Page): 12 of 14

西北臺慶科技股份有限公司 / TAI-TECH ADVANCED ELECTRONICS CO., LTD.



(臺慶精密電子(昆山)有限公司 / TAI-TECH ADVANCED ELECTRONICS (KUN-SHAN) CO. LTD.)

(慶邦電子元器件(泗洪)有限公司 / TAIPAQ ELECTRONICS (SI-HONG) CO., LTD.)

桃園市楊梅區幼獅工業區幼四路1號 / NO. 1, YOU 4TH ROAD, YOUTH INDUSTRIAL DISTRICT, YANG-MEI, TAO-YUAN CITY, TAIWAN, R. O. C.

(江蘇省昆山市蓬朗昆嘉高科技工業區郭澤路 / GUO-ZE ROAD, KUNJIA HI-TECH INDUSTRIAL PARK, KUN-SHAN, JIANG-SU, CHINA)

(中國, 江蘇省, 宿遷市, 泗洪縣, 經濟開發區杭州路南側, 建設北路東側 / THE SOUTH HANGZHOU ROAD AND THE EAST JIANSHE ROAD, ECONOMIC DEVELOPMENT ZONE, SIHONG COUNTY, SUQIANCITY, JIANGSU PROVINCE, P, R, CHINA)

聚氯乙烯物質判定分析流程圖 / Analysis flow chart - PVC

- 測試人員: 涂雅苓 / Technician: Yaling Tu
- 測試負責人: 張啟興 / Supervisor: Troy Chang

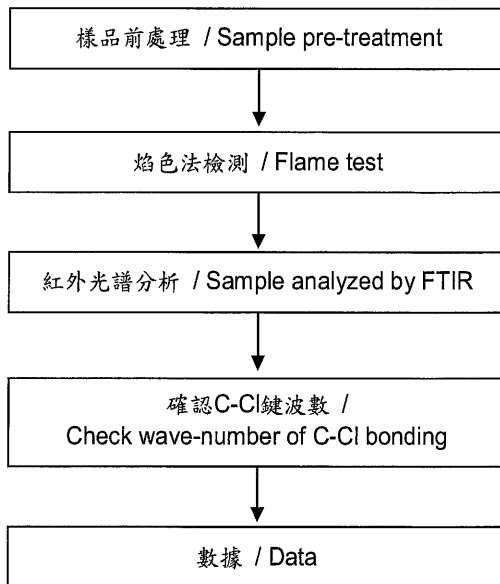

This document is issued by the Company subject to its General Conditions of Service printed overleaf, available on request or accessible at <http://www.sgs.com/en/Terms-and-Conditions.aspx> and, for electronic format documents, subject to Terms and Conditions for Electronic Documents at <http://www.sgs.com/en/Terms-and-Conditions.aspx>. Attention is drawn to the limitation of liability, indemnification and jurisdiction issues defined therein. Any holder of this document is advised that information contained hereon reflects the Company's findings at the time of its intervention only and within the limits of client's instruction, if any. The Company's sole responsibility is to its Client and this document does not exonerate parties to a transaction from exercising all their rights and obligations under the transaction documents. This document cannot be reproduced, except in full, without prior written approval of the Company. Any unauthorized alteration, forgery or falsification of the content or appearance of this document is unlawful and offenders may be prosecuted to the fullest extent of the law. Unless otherwise stated the results shown in this test report refer only to the sample(s) tested.



測試報告

Test Report

號碼(No.) : CE/2018/34305

日期(Date) : 2018/03/22

頁數(Page): 13 of 14

西北臺慶科技股份有限公司 / TAI-TECH ADVANCED ELECTRONICS CO., LTD.



(臺慶精密電子(昆山)有限公司 / TAI-TECH ADVANCED ELECTRONICS (KUN-SHAN) CO. LTD.)

(慶邦電子元器件(泗洪)有限公司 / TAIPAQ ELECTRONICS (SI-HONG) CO., LTD.)

桃園市楊梅區幼獅工業區幼四路1號 / NO. 1, YOU 4TH ROAD, YOUTH INDUSTRIAL DISTRICT, YANG-MEI, TAO-YUAN CITY, TAIWAN, R. O. C.

(江蘇省昆山市蓬朗昆嘉高科技工業區郭澤路 / GUO-ZE ROAD, KUNJIA HI-TECH INDUSTRIAL PARK, KUN-SHAN, JIANG-SU, CHINA)

(中國, 江蘇省, 宿遷市, 泗洪縣, 經濟開發區杭州路南側, 建設北路東側 / THE SOUTH HANGZHOU ROAD AND THE EAST JIANSHE ROAD, ECONOMIC DEVELOPMENT ZONE, SIHONG COUNTY, SUQIANCITY, JIANGSU PROVINCE, P, R, CHINA)

根據以下的流程圖之條件, 樣品已完全溶解。 / These samples were dissolved totally by pre-conditioning method according to below flow chart.

- 測試人員: 王志瑋 / Technician: JR Wang
- 測試負責人: 張啟興 / Supervisor: Troy Chang

元素以 ICP-AES 分析的消化流程圖 (Flow Chart of digestion for the elements analysis performed by ICP-AES)

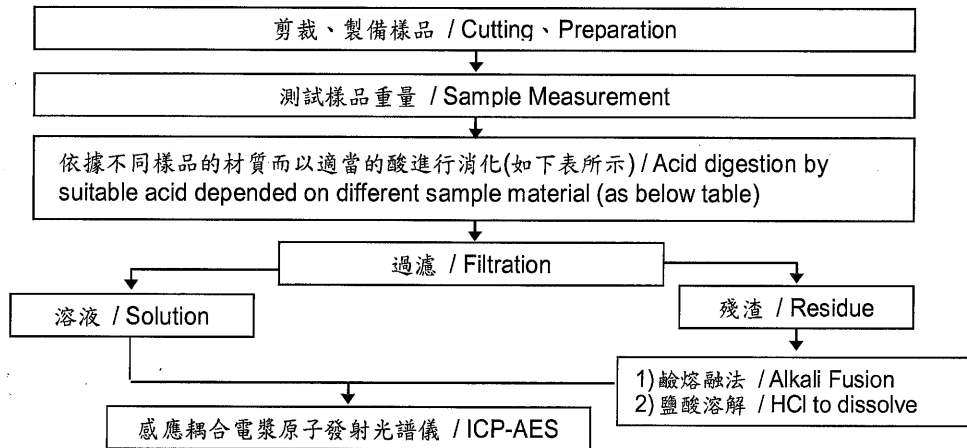

| | |
|--|---|
| 鋼, 銅, 鋁, 焊錫 / Steel, copper, aluminum, solder | 王水, 硝酸, 鹽酸, 氫氟酸, 雙氧水 / Aqua regia, HNO ₃ , HCl, HF, H ₂ O ₂ |
| 玻璃 / Glass | 硝酸, 氫氟酸 / HNO ₃ /HF |
| 金, 鈷, 鈀, 陶瓷 / Gold, platinum, palladium, ceramic | 王水 / Aqua regia |
| 銀 / Silver | 硝酸 / HNO ₃ |
| 塑膠 / Plastic | 硫酸, 雙氧水, 硝酸, 鹽酸 / H ₂ SO ₄ , H ₂ O ₂ , HNO ₃ , HCl |
| 其他 / Others | 加入適當的試劑至完全溶解 / Added appropriate reagent to total digestion |

This document is issued by the Company subject to its General Conditions of Service printed overleaf, available on request or accessible at <http://www.sgs.com/ta/terms-and-conditions.html> and, for electronic format documents, subject to Terms and Conditions for Electronic Documents at <http://www.sgs.com/ta/terms-and-conditions.html>. Attention is drawn to the limitation of liability, indemnification and jurisdiction issues defined therein. Any holder of this document is advised that information contained hereon reflects the Company's findings at the time of its intervention only and within the limits of client's instruction, if any. The Company's sole responsibility is to its Client and this document does not exonerate parties to a transaction from exercising all their rights and obligations under the transaction documents. This document cannot be reproduced, except in full, without prior written approval of the Company. Any unauthorized alteration, forgery or falsification of the content or appearance of this document is unlawful and offenders may be prosecuted to the fullest extent of the law. Unless otherwise stated the results shown in this test report refer only to the sample(s) tested.

測試報告

Test Report

號碼(No.) : CE/2018/34305

日期(Date) : 2018/03/22

頁數(Page): 14 of 14

西北臺慶科技股份有限公司 / TAI-TECH ADVANCED ELECTRONICS CO., LTD.

(臺慶精密電子(昆山)有限公司 / TAI-TECH ADVANCED ELECTRONICS (KUN-SHAN) CO. LTD.)

(慶邦電子元器件(泗洪)有限公司 / TAIPAQ ELECTRONICS (SI-HONG) CO., LTD.)

桃園市楊梅區幼獅工業區幼四路1號 / NO. 1, YOU 4TH ROAD, YOUTH INDUSTRIAL DISTRICT, YANG-MEI, TAO-YUAN CITY, TAIWAN, R. O. C.

(江蘇省昆山市蓬朗昆嘉高科技工業區郭澤路 / GUO-ZE ROAD, KUNJIA HI-TECH INDUSTRIAL PARK, KUN-SHAN, JIANG-SU, CHINA)

(中國, 江蘇省, 宿遷市, 泗洪縣, 經濟開發區杭州路南側, 建設北路東側 / THE SOUTH HANGZHOU ROAD AND THE EAST JIANSHE ROAD, ECONOMIC DEVELOPMENT ZONE, SIHONG COUNTY, SUQIANCITY, JIANGSU PROVINCE, P, R, CHINA)



* 照片中如有箭頭標示, 則表示為實際檢測之樣品/部位. *

(The tested sample / part is marked by an arrow if it's shown on the photo.)

CE/2018/34305

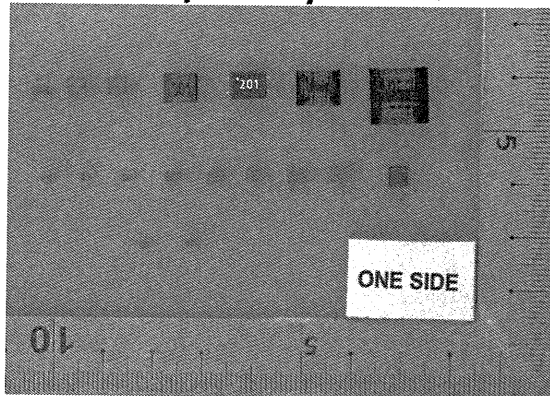

CE/2018/34305

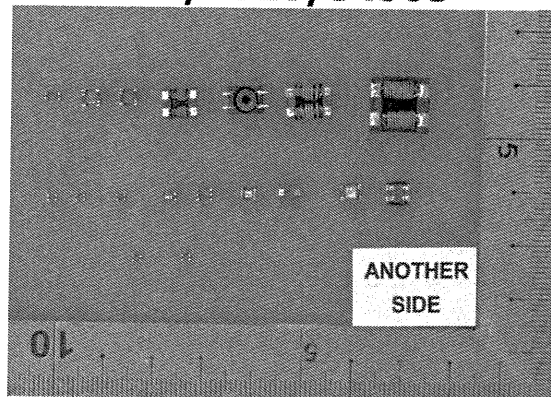

** 報告結尾 (End of Report) **

This document is issued by the Company subject to its General Conditions of Service printed overleaf, available on request or accessible at <http://www.sgs.com/en/Terms-and-Conditions.aspx> and, for electronic format documents, subject to Terms and Conditions for Electronic Documents at <http://www.sgs.com/en/Terms-and-Conditions-for-Electronic-Documents.aspx>. Attention is drawn to the limitation of liability, indemnification and jurisdiction issues defined therein. Any holder of this document is advised that information contained hereon reflects the Company's findings at the time of its intervention only and within the limits of client's instruction, if any. The Company's sole responsibility is to its Client and this document does not exonerate parties to a transaction from exercising all their rights and obligations under the transaction documents. This document cannot be reproduced, except in full, without prior written approval of the Company. Any unauthorized alteration, forgery or falsification of the content or appearance of this document is unlawful and offenders may be prosecuted to the fullest extent of the law. Unless otherwise stated the results shown in this test report refer only to the sample(s) tested.