

Nano-Power, RRIO, 2.3V, Push-Pull Output Comparator with Voltage Reference

FEATURES

- Low supply current: $3.5\mu\text{A}$ (TYP) at $V_s=2.3\text{V}$
- Supply Range: $+2.3\text{V}$ to $+5.5\text{V}$
- Integrated Voltage Reference: 1.2V
- Low input offset voltage: $V_{os}(\text{max}) = 3.5\text{mV}$ at $V_s=5\text{V}$
- Rail-to-Rail Input
- Push-Pull Output
- Operating Temperature Range: -40°C to $+85^\circ\text{C}$
- *Micro* SIZE PACKAGES: SOT23-6, DFN1.6*1.6-6L

APPLICATIONS

- RC TIMERS
- MULTIVIBRATORS
- WINDOW DETECTORS
- SYSTEM MONITORING
- SENSOR SYSTEMS: Smoke Detectors, Light Sensors, Alarms

DESCRIPTION

The RS8912 is a push-pull output comparator. It features an uncommitted on-chip voltage reference and have low quiescent current, input common-mode range 200mV beyond the supply rails, and single-supply operation from 2.3V to 5.5V . The integrated 1.2V series voltage reference offers low $42\mu\text{V}/^\circ\text{C}$ drift, is stable with up to 10nF capacitive load, and can provide up to $350\mu\text{A}$ (TYP) of output current.

Featuring a push-pull output stage, the RS8912 allows for operation with absolute minimum power consumption when driving any capacitive or resistive load.

The RS8912 is available in Green SOT23-6 and DFN1.6*1.6-6L package, it is specified at the full temperature range of -40°C to $+85^\circ\text{C}$.

Device Information ⁽¹⁾

PART NUMBER	PACKAGE	BODY SIZE (NOM)
RS8912	SOT23-6	$1.60\text{mm} \times 2.92\text{mm}$
	DFN1.6*1.6-6L	$1.60\text{mm} \times 1.60\text{mm}$

(1) For all available packages, see the orderable addendum at the end of the data sheet.

Pin Configuration and Functions (Top View)

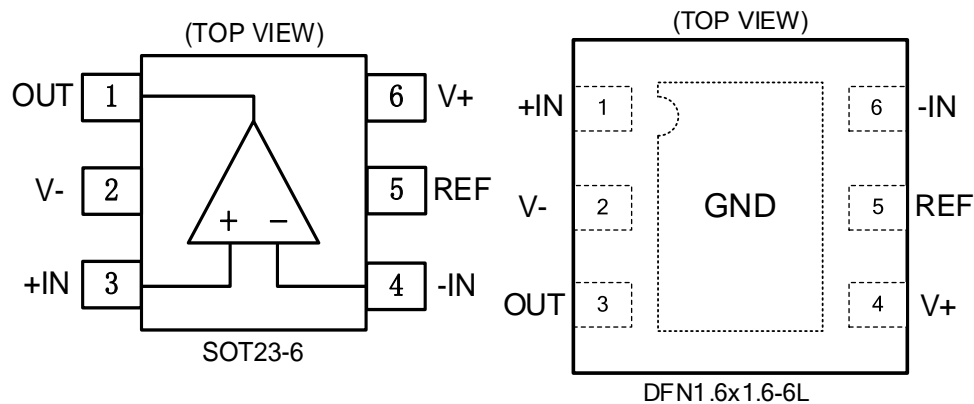

Pin Description

NAME	PIN		I/O ⁽¹⁾	DESCRIPTION
	SOT23-6	DFN1.6x1.6-6L		
OUT	1	3	O	Output
V-	2	2	P	Negative (lowest) power supply
+IN	3	1	I	Noninverting input
-IN	4	6	I	Inverting input
REF	5	5	O	Voltage Reference
V+	6	4	P	Positive (highest) power supply

(1)I=Input, O=Output, P=Power

SPECIFICATIONS

Absolute Maximum Ratings

Over operating free-air temperature range (unless otherwise noted) ⁽¹⁾

		MIN	MAX	UNIT
Voltage	Supply, $V_s=(V+) - (V-)$		7	V
	Input pin (IN+, IN-) ⁽²⁾	(V-)-0.5	(V+) +0.5	
	Signal output pin ⁽³⁾	(V-)-0.5	(V+) +0.5	
Current	Signal input pin (IN+, IN-) ⁽²⁾	-10	10	mA
	Signal output pin ⁽³⁾	-10	10	mA
	Output short-circuit ⁽⁴⁾	Continuous		
Temperature	Operating range, T_A	-40	85	°C
	Junction, T_J		150	
	Storage, T_{stg}	-65	150	

(1) Stresses above these ratings may cause permanent damage. Exposure to absolute maximum conditions for extended periods may degrade device reliability. These are stress ratings only, and functional operation of the device at these or any other conditions beyond those specified is not implied.

(2) Input terminals are diode-clamped to the power-supply rails. Input signals that can swing more than 0.5V beyond the supply rails should be current-limited to 10mA or less.

(3) Output terminals are diode-clamped to the power-supply rails. Output signals that can swing more than 0.5V beyond the supply rails should be current-limited to ± 10 mA or less.

(4) Short-circuit to ground, one amplifier per package.

ESD Ratings

			VALUE	UNIT
$V_{(ESD)}$	Electrostatic discharge	Human-body model (HBM)	± 3000	V
		Machine Model (MM)	± 200	

Recommended Operating Conditions

Over operating free-air temperature range (unless otherwise noted)

		MIN	NOM	MAX	UNIT
Supply voltage, $V_s= (V+) - (V-)$	Single-supply	2.3		5.5	V
	Dual-supply	± 1.15		± 2.75	

Thermal Information:RS8912

THERMAL METRIC ⁽¹⁾		RS8912	UNIT
		6PINS	
		SOT23-6	
$R_{\theta JA}$	Junction-to-ambient thermal resistance	214.7	°C/W
$R_{\theta JC(top)}$	Junction-to-case(top) thermal resistance	127.1	°C/W
$R_{\theta JB}$	Junction-to-board thermal resistance	60.0	°C/W
Ψ_{JT}	Junction-to-top characterization parameter	33.4	°C/W
Ψ_{JB}	Junction-to-board characterization parameter	59.8	°C/W
$R_{\theta JC(bot)}$	Junction-to-case(bottom) thermal resistance	N/A	°C/W

PACKAGE/ORDERING INFORMATION

Orderable Device	Package Type	Pin	Channel	Op Temp(°C)	Device Marking ⁽¹⁾	Package Qty
RS8912XH	SOT23-6	6	1	-40°C~85°C	8912	Tape and Reel,3000
RS8912XUTDL6	DFN1.6*1.6-6L	6	1	-40°C~85°C	8912	Tape and Reel,3000

NOTE:

- (1) There may be additional marking, which relates to the lot trace code information(data code and vendor code), the logo or the environmental category on the device.

ELECTRICAL CHARACTERISTICS: $V_S=2.3V$

 (At $T_A = +25^\circ C$, $V_+ = 2.3V$, $V_- = 0V$, $V_{CM} = V_S/2$, unless otherwise noted.)

PARAMETER		CONDITIONS	RS8912			UNITS
			MIN	TYP	MAX	
POWER SUPPLY						
V_S	Operating Voltage Range		2.3		5.5	V
I_Q	Quiescent Current			3.5	8	μA
PSRR	Power-Supply Rejection Ratio	$V_S = 2.3V$ to $5.5V$, $V_{CM} = (V) + 0.5V$		70		dB
INPUT						
V_{OS}	Input Offset Voltage	$V_{CM} = 0V$		1	5	mV
		$V_{CM} = 2.3V$		1	5	
$\Delta V_{OS}/\Delta T$	Input Offset Voltage Drift	$V_{CM} = V_S/2$, $-40^\circ C \leq T_A \leq 85^\circ C$		2		$\mu V/^\circ C$
I_B	Input Bias Current			1	10	pA
V_{CM}	Common-Mode Voltage Range	$T_A = -40^\circ C$ to $85^\circ C$	(V-)-0.1		(V+)+0.1	V
CMRR	Common-Mode Rejection Ratio	$V_{CM} = 0V$ to $2.3V$		70		dB
OUTPUT						
V_{OH}	Output Swing From Upper Rail	$I_O = 25\mu A$	2.208	2.237		V
		$I_O = 95\mu A$	2.011	2.095		
V_{OL}	Output Swing From Lower Rail	$I_O = 25\mu A$		55	80	mV
		$I_O = 95\mu A$		205	289	
I_{SC}	Short Circuit Sink Current	$V_S = 2.3V$		-1	-0.62	mA
	Short Circuit Source Current	$V_S = 2.3V$	0.57	1		mA
SWITCHING						
T_{PHL}	Propagation Delay H To L	Overdrive = 10 mV		135		μs
		Overdrive = 100 mV		21		
T_{PLH}	Propagation Delay L To H	Overdrive = 10 mV		123		μs
		Overdrive = 100 mV		40		
T_R	Rise Time	Overdrive = 100 mV		30		us
T_F	Fall Time	Overdrive = 100 mV		30		us
	Noise of V_{REF}	$f = 0.1Hz$ to $10Hz$		20		μV_{RMS}
VOLTAGE REFERENCE						
V_{REF}	Reference Voltage	$I_{REF} = 0mA$	1.176	1.200	1.224	V
	Reference Voltage Drift			42		$\mu V/^\circ C$
	Reference Output Current (Source)		60	80		μA

ELECTRICAL CHARACTERISTICS: $V_S=5V$

 (At $T_A = +25^\circ C$, $V_+ = 5V$, $V_- = 0V$, $V_{CM} = V_S/2$, unless otherwise noted.)

PARAMETER		CONDITIONS	RS8912			UNITS
			MIN	TYP	MAX	
POWER SUPPLY						
V_S	Operating Voltage Range		2.3		5.5	V
I_Q	Quiescent Current			4.85	10	μA
PSRR	Power-Supply Rejection Ratio	$V_S = 2.3V$ to $5.5V$, $V_{CM} = (V_+) + 0.5V$		70		dB
INPUT						
V_{OS}	Input Offset Voltage	$V_{CM} = 0V$		1	3.5	mV
		$V_{CM} = 5V$		1	3.5	
$\Delta V_{OS}/\Delta T$	Input Offset Voltage Drift	$V_{CM} = V_S/2$, $-40^\circ C \leq T_A \leq 85^\circ C$		2		$\mu V/^\circ C$
I_B	Input Bias Current			1	10	pA
V_{CM}	Common-Mode Voltage Range	$T_A = -40^\circ C$ to $85^\circ C$	(V_-)-0.1		(V_+)+0.1	V
CMRR	Common-Mode Rejection Ratio	$V_{CM} = 0V$ to $5V$		70		dB
OUTPUT						
V_{OH}	Output Swing From Upper Rail	$I_O = 25\mu A$	4.915	4.935		V
		$I_O = 95\mu A$	4.720	4.785		
V_{OL}	Output Swing From Lower Rail	$I_O = 25\mu A$		55	72	mV
		$I_O = 95\mu A$		215	280	
I_{SC}	Short Circuit Sink Current	$V_S = 5V$		-2.25	-2.2	mA
	Short Circuit Source Current	$V_S = 5V$	2.15	2.23		mA
SWITCHING						
T_{PHL}	Propagation Delay H To L	Overdrive = 10 mV		67		μs
		Overdrive = 100 mV		12		
T_{PLH}	Propagation Delay L To H	Overdrive = 10 mV		68		
		Overdrive = 100 mV		12		
T_R	Rise Time	Overdrive = 100 mV		12		us
T_F	Fall Time	Overdrive = 100 mV		12		us
	Noise of V_{REF}	$f = 0.1Hz$ to $10Hz$		20		μV_{RMS}
VOLTAGE REFERENCE						
V_{REF}	Reference Voltage	$I_{REF} = 0mA$	1.176	1.200	1.224	V
	Reference Voltage Drift			42		$\mu V/^\circ C$
	Reference Output Current (Source)		200	350		μA

TYPICAL CHARACTERISTICS

At $T_A = +25^\circ\text{C}$, $V_S=5\text{V}$, $V_{CM} = V_S/2$, $C_L=15\text{pF}$ unless otherwise noted.

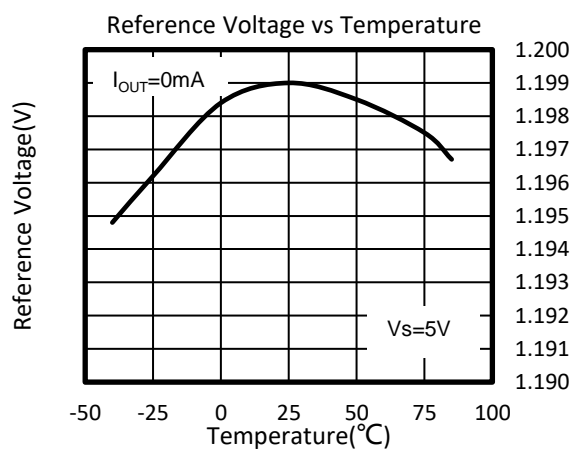
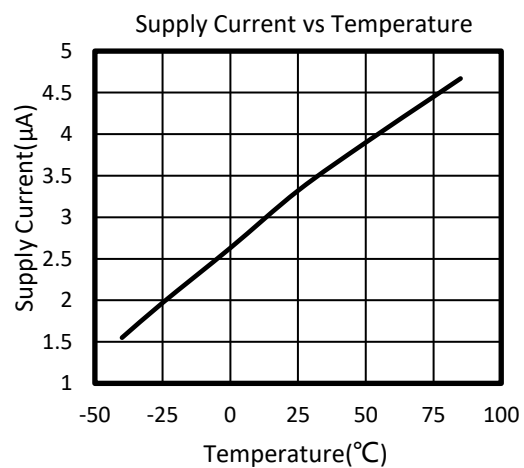
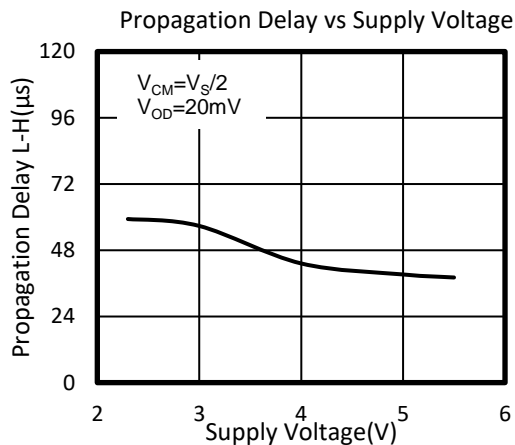
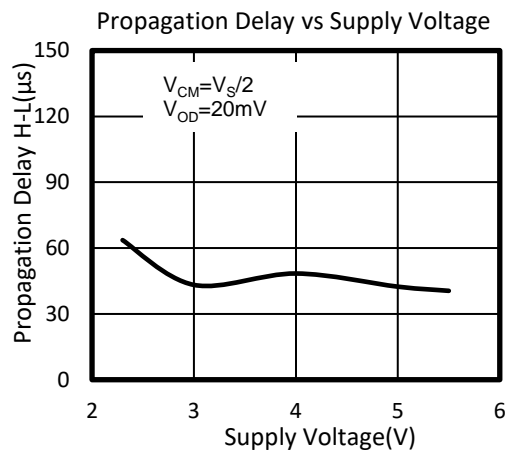
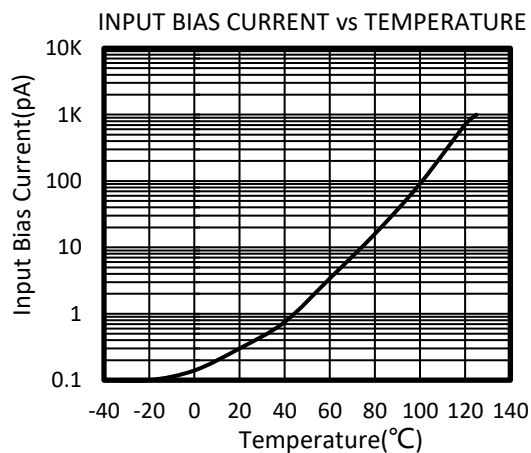
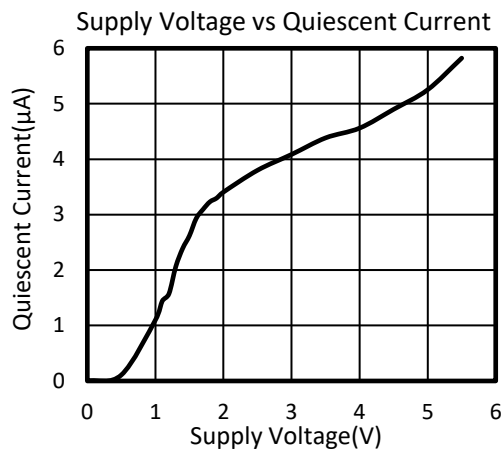

TYPICAL CHARACTERISTICS

At $T_A = +25^\circ\text{C}$, $V_S=5\text{V}$, $V_{CM} = V_S/2$, $C_L=15\text{pF}$ unless otherwise noted.

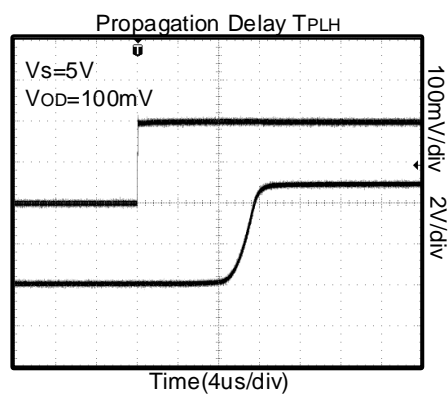
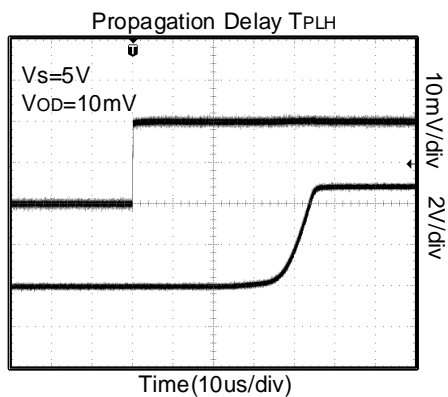
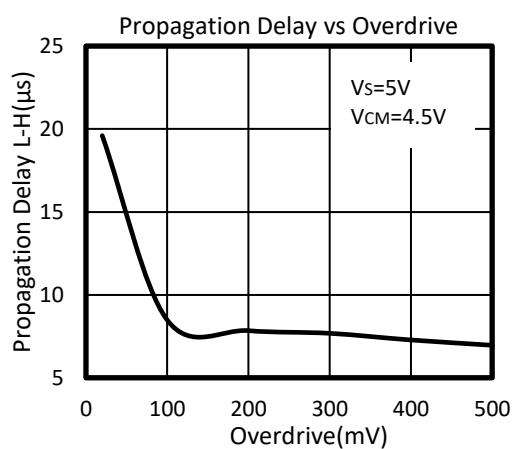
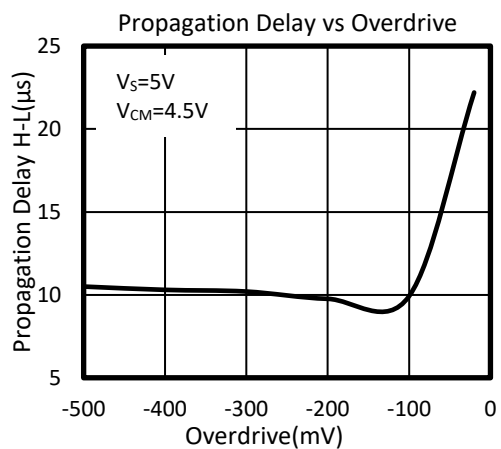
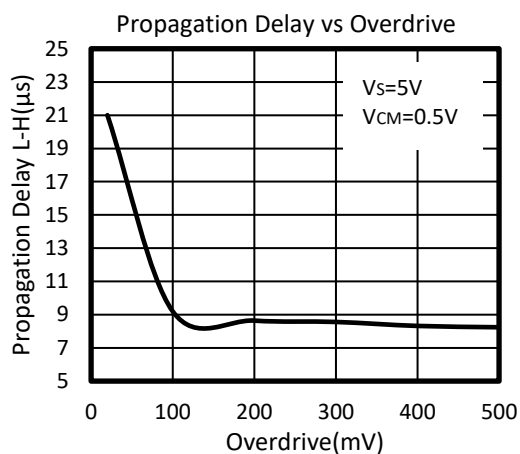
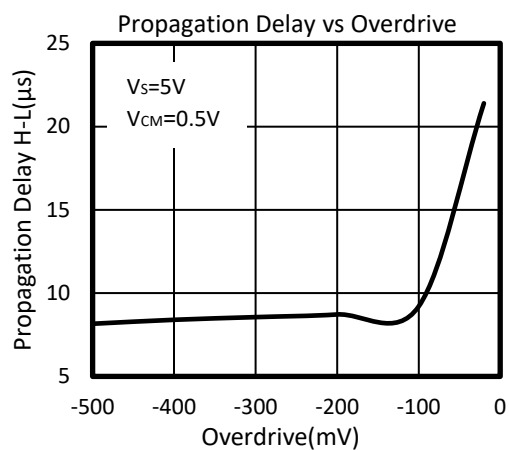

TYPICAL CHARACTERISTICS

At $T_A = +25^\circ\text{C}$, $V_S = 5\text{V}$, $V_{CM} = V_S/2$, $C_L = 15\text{pF}$ unless otherwise noted.

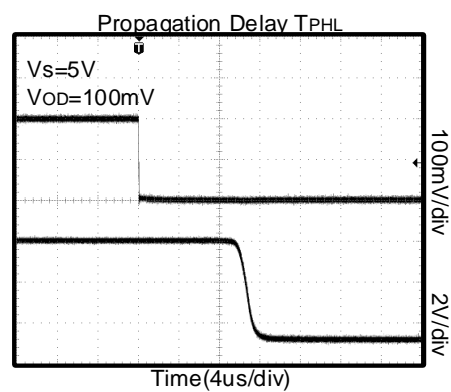
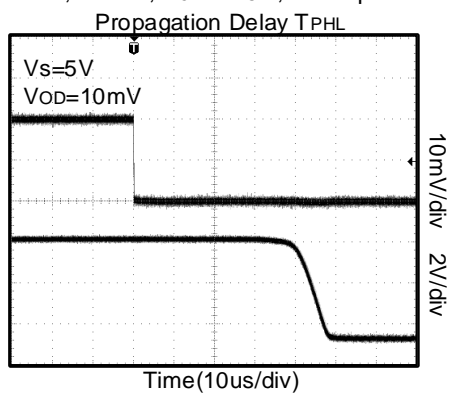

PACKAGE OUTLINE DIMENSIONS

SOT23-6

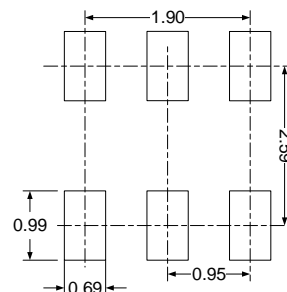
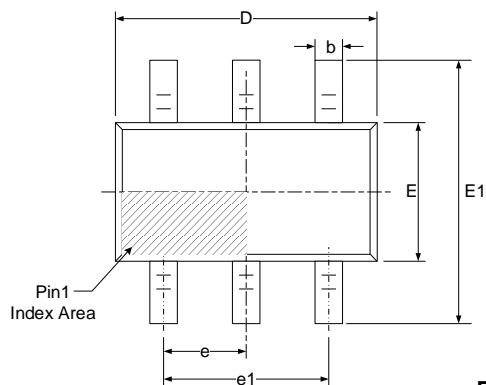
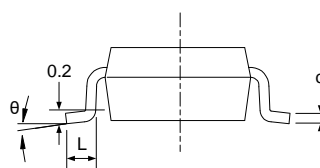
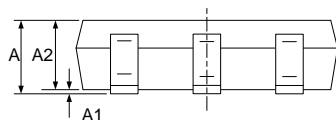

RECOMMENDED LAND PATTERN (Unit: mm)

Symbol	Dimensions In Millimeters		Dimensions In Inches	
	Min	Max	Min	Max
A	1.050	1.250	0.041	0.049
A1	0.000	0.100	0.000	0.004
A2	1.050	1.150	0.041	0.045
b	0.300	0.500	0.012	0.020
c	0.100	0.200	0.004	0.008
D	2.820	3.020	0.111	0.119
E	1.500	1.700	0.059	0.067
E1	2.650	2.950	0.104	0.116
e	0.950(BSC)		0.037(BSC)	
e1	1.800	2.000	0.071	0.079
L	0.300	0.600	0.012	0.024
θ	0°	8°	0°	8°

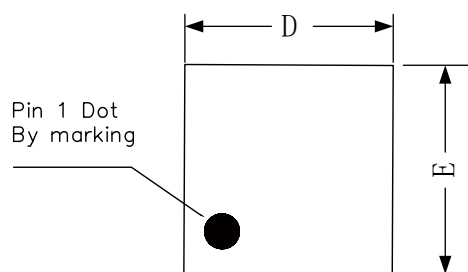
DFN1.6x1.6-6L

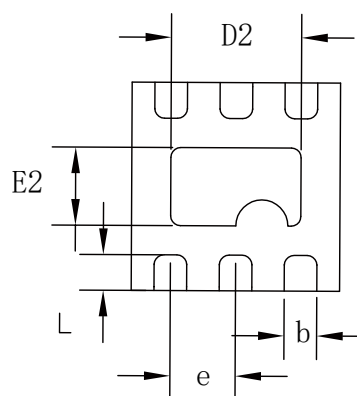

TOP VIEW



BOTTOM VIEW

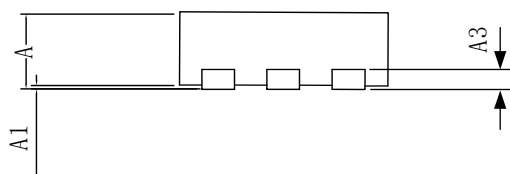

SIDE VIEW

Symbol	Dimensions In Millimeters		Dimensions In Inches	
	Min	Max	Min	Max
A	0.500	0.600	0.020	0.024
A1	0.000	0.050	0.000	0.002
A3	0.150 REF		0.006 REF	
D	1.550	1.650	0.061	0.065
E	1.550	1.650	0.061	0.065
D2	0.900	1.050	0.035	0.041
E2	0.500	0.650	0.020	0.025
L	0.200	0.300	0.008	0.012
b	0.200	0.300	0.008	0.012
e	0.500 BSC		0.020 BSC	