

## 产 品 规 格 书

### SPECIFICATIONS FOR PRODUCT

产品类型 TYPE : SMD3225

产品规格 SPEC : 24MHz/3225/8PF/10PPM

产品型号 P/N : CJ13-240000810B20

日期 DATE : 2021/05/06

<b>核准及签名</b>			<b>部门</b>
R&D APPR. SIGNATURED			DEPT.
<b>拟制</b>	<b>审核</b>	<b>批准</b>	频率器件事业部
ISSUE	CHECK	APPROVAL	
Ivan 2021/05/06	Abbey 2021/05/06	Ken 2021/05/06	



**SMCE3225 4 pads Crystal Resonator**

**CJ13-240000810B20**

1. Scope:

- 1.1 This specification applies to the RoHS/SONY compliance quartz crystal unit with a frequency of 24MHz which will be used in crystal oscillator applications.

2. Construction:

- 2.1 Type of Quartz Resonator: SMCE3225 4pads

3. Electrical Characteristics

- 3.1 Nominal Frequency(f): 24MHz
- 3.2 Load Capacitance( $C_L$ ): 8pF
- 3.3 Frequency Tolerance( $\Delta f/f$ ):  $\pm 10$ ppm
- 3.4 Frequency Temperature Stability:  $\pm 20$ ppm
- 3.5 Resonance Resistance(ohm): 40ohms Max
- 3.6 Osc mode: Fundamental mode
- 3.7 Shunt Capacitance( $C_0$ ):  $< 2$ pF
- 3.8 Drive Level( $D_L$ ):  $< 100$  $\mu$ W
- 3.9 Operating Temperature Range( $T_{OPR}$ ): -40 to + 85
- 3.10 Storage Temperature Range( $T_{STG}$ ): -55 to + 125°C
- 3.11 Insulation Resistance(IR):  $> 500$  M ohms
- 3.12 Aging( $\Delta f_A$ ):  $\pm 3$ ppm per Year

## 4. Reliability Specifications

This is the quality control and quality assurance and reliability tests performance data for the RoHS/

SONY compliance 24MHz SMCE3225 4pads crystal resonators

related to the specification and approval sheet provided by JSCJ .

Standard test condition (TEMP.: 20±5°C. Relative humidity: 65±20%)

For any discrepancy in GO/NG, test will be done at TEMP.25±2°C, R.H. 65±5%.

NO.	PROCESS	SPECIFICATION	TEST METHOD
4.1	Temperature Cycle (GB/T 2423.22-2002, Method Nb)	Frequency change after test $\pm 5$ ppm. Resonance resistance change after test $\leq 10$ ohms.	10 cycles from -55°C to 125°C. Measurement taken after DUT being left at room temperature for 24±2 hours.
4.2	Low Temperature Storage (GB/T 2423.1-2001, Method Aa)	Frequency change after test $\pm 5$ ppm. Resonance resistance change after test $\leq 10$ ohms.	Spending 72 hrs at -55°C±3°C constant temperature. Measurement taken after DUT being left at room temperature for 24±2 hours.
4.3	High Temperature Storage (GB/T 2423.2-2001, Method Ba)	Frequency change after test $\pm 5$ ppm. Resonance resistance change after test $\leq 10$ ohms.	Spending 72 hrs at 125°C±3°C constant temperature. Measurement taken after DUT being left at room temperature for 24±2 hours.
4.4	Humidity (GB/T 2423.3-2006, Method Cab)	Frequency change after test $\pm 5$ ppm. Resonance resistance change after test $\leq 10$ ohms.	Spending 96 hrs at 40 °C ± 3 °C, with 93 %R.H, Then keep the DUT in dry oven at 40 ± 5 °C for 24 hour. Measurement taken after DUT being left at room temperature for 1 to 2 hours.
4.5	Vibration (GB/T 2423.10-1995, Method Fc)	Frequency change after test $\pm 5$ ppm. Resonance resistance change after test $\leq 10$ ohms.	Apply 0.75mm vibration at sweep frequency 10~500 Hz, 10 cycles in each direction of 3 axis. Measurement taken after 1 hour.
4.6	Shock (GB/T 2423.5-1995, Method Ea)	Frequency change after test $\pm 5$ ppm. Resonance resistance change after test $\leq 10$ ohms. and exhibit no visible damage.	Peak 1000m/s <sup>2</sup> , normal width 6ms half sine wave form, 3.7m/s, 3 perpendicular axis of samples, 3 cycles / direction, total 18 cycles. Measurement taken after 1 hour.
4.7	Drop (GB/T 2423.8-1995, Method Ed)	Frequency change after test $\pm 5$ ppm. Resonance resistance change after test $\leq 10$ ohms. and exhibit no visible damage.	Free drop to the steel plate with thickness of 3 mm from 1.00 m heights for 3 times.
4.8	Solderability (IEC60068-2-58, Test Td:)	Terminals shall be covered more than 95% with solder.	Passed through the re-flow oven under the following condition. Preheat 150 to 180°C for 60 to 120sec, and soldering time for 20s ± 5s at 235°C, peak soldering time for 10s ± 1s between 240 and 250°C. There is no need to do functional test. 8-12X magnifier.
4.9	Terminal Strength (JIS-C-6429 Method 1 & 2 )	No visible damage	Mount on a glass-epoxy board (100x50x1.6mm), then bend to 2mm displacement (velocity 1mm/sec) and keep for 5 seconds. or pulling force 1.8kg for at least 60 seconds.
4.10	Resistance to Soldering Heat (IEC60068-2-58, Test Td: Table 4)	Frequency change after test $\pm 5$ ppm. Resonance resistance change after test $\leq 10$ ohms.	Passed through the re-flow oven under the following condition. Preheat 150 to 180°C for 60 to 120sec, and soldering time for 60s max at 235°C, peak soldering time for 20s max at 265°C max. Measurement taken after DUT being left at room temperature for at least 2 hours.
4.11	OTHERS		

---

## Recommended Reflow soldering conditon

---

### 5. Recommended Reflow soldering condition (SMD)

Solder profile

Peak:  $260 \pm 5^\circ\text{C}$  Soldering zone:  $230^\circ\text{C}$  or more,  $30 \pm 10\text{s}$ . Pre-heating zone 1:  $150 \sim 180^\circ\text{C}$ ,  $90 \pm 30\text{s}$

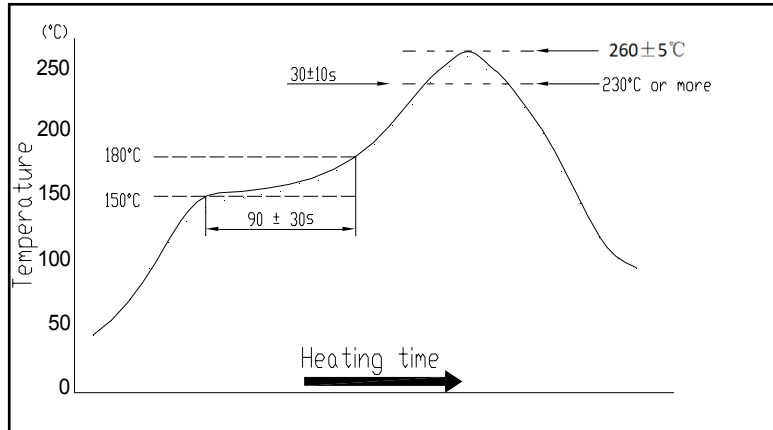

Temperature profile for reflow soldering

### 6. Soldering iron method

Bit temperature:  $350 \pm 10^\circ\text{C}$  Application time of soldering iron:  $3+1\text{ s}$ . For other procedures, refer to IEC 60068-2-20.

## Package Outline Dimensions

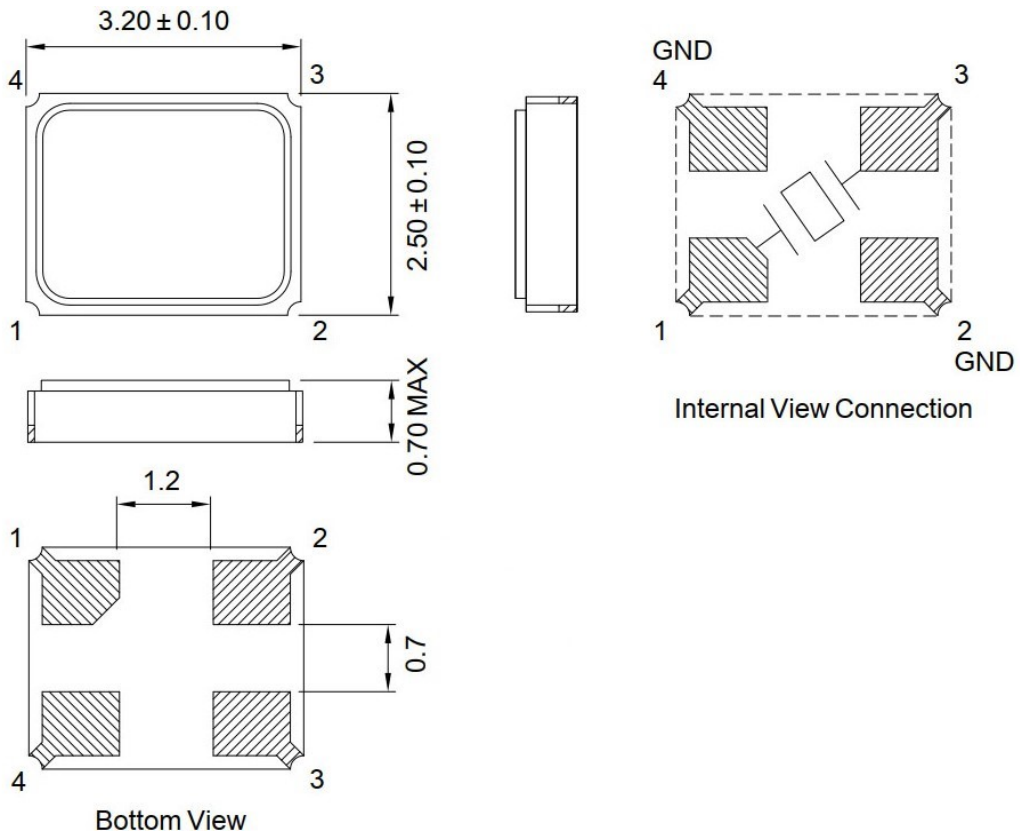

## Suggested Pad Layout

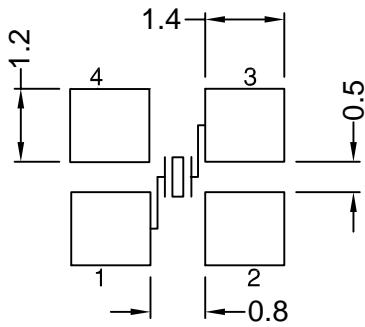

---

## Inside Structure

---



No.	Components	Materials
1	Package	Ceramic( $\text{Al}_2\text{O}_3$ )
2	Lid	KV(Fe/Ni/Co)
3	Crystal blank	$\text{SiO}_2$
4	Electrode	Ag, Cr
5	Silver glue	Ag, $\text{CH}_3\text{OH}$ , $\text{SiO}_2$

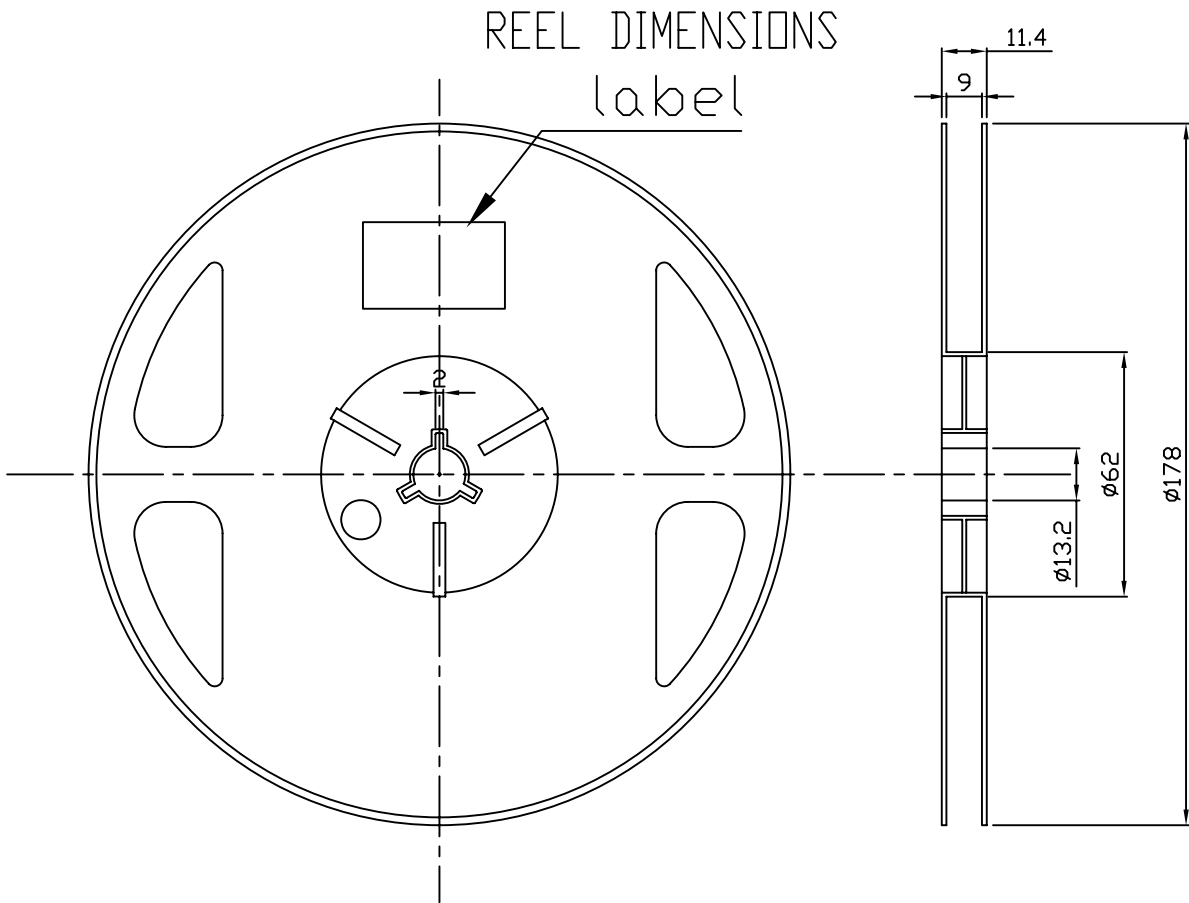

EMBOSSED TYPE DIMENSIONS

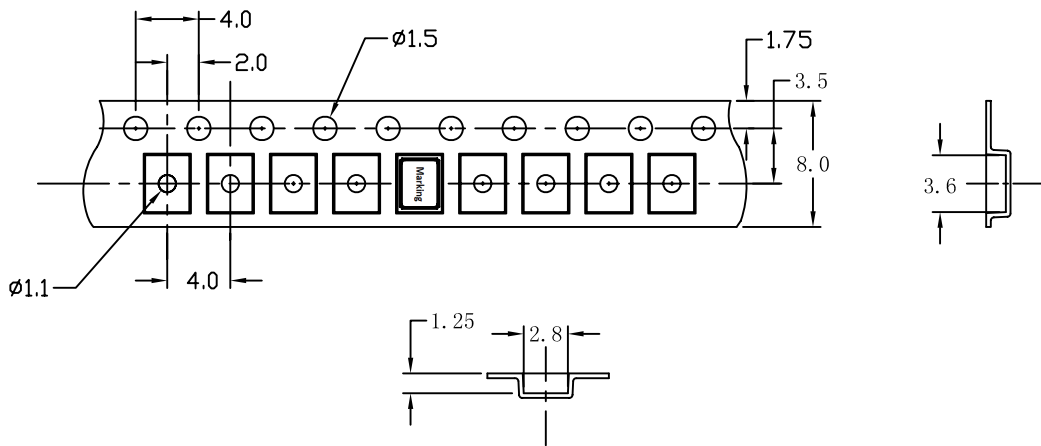

USER FEED DIRECTION

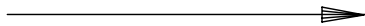

# Package

## Inside package

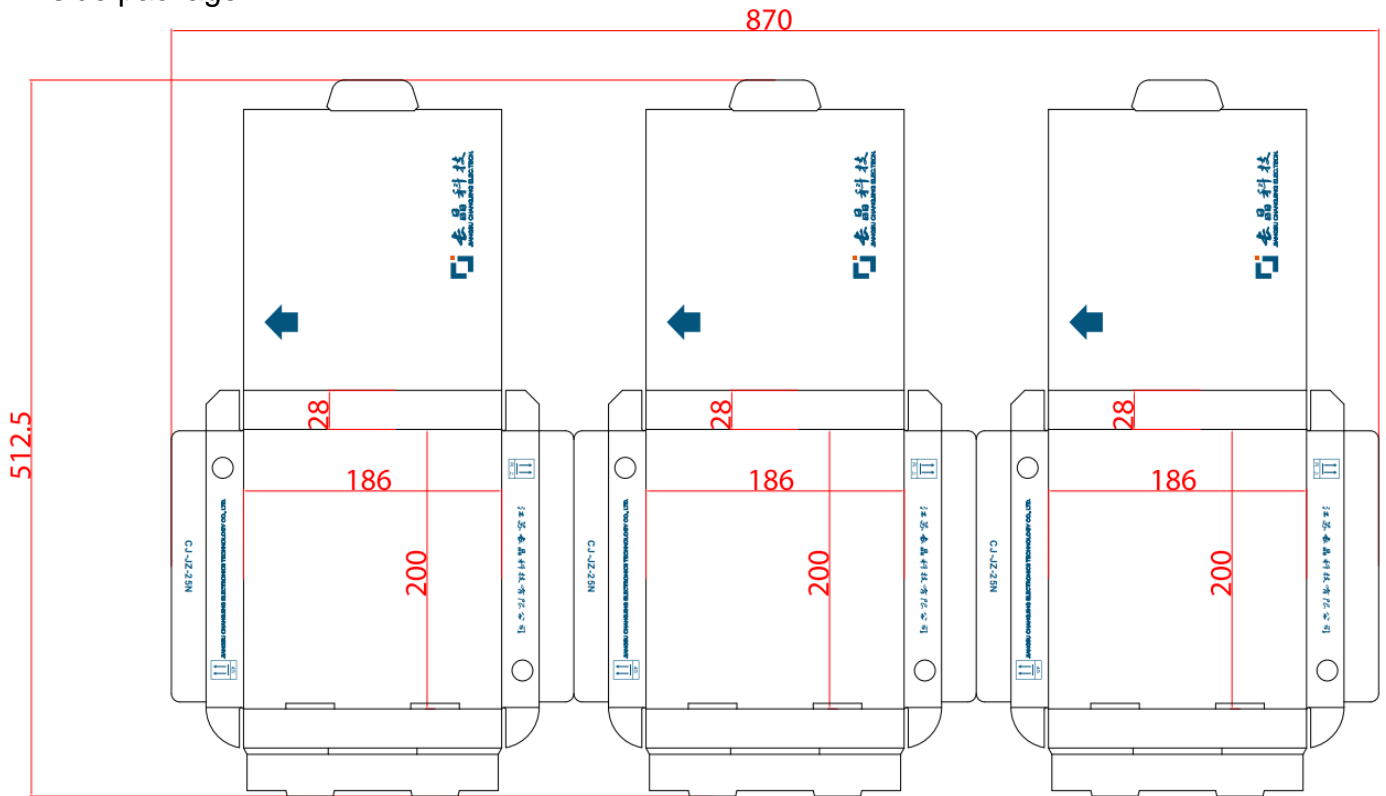

## Outside package

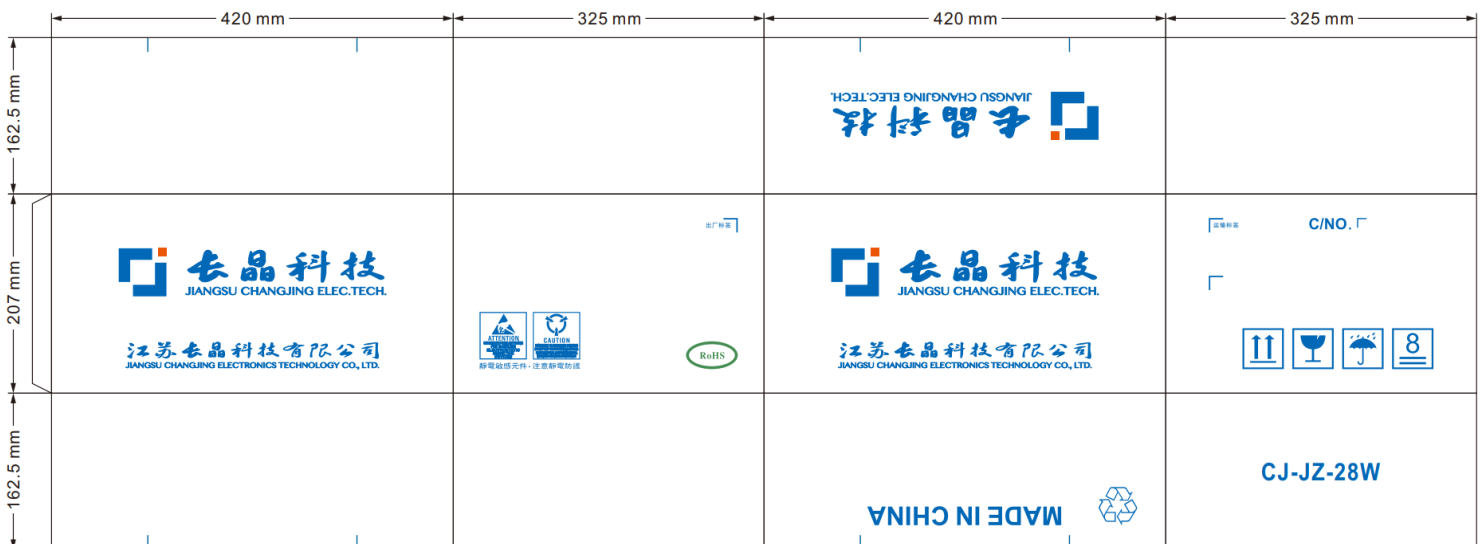

### NOTICE

JSCJ reserve the right to make modifications,enhancements, improvements, corrections or other changes without further notice to any product herein.JSCJ does not assume any liability arising out of the application or use of any product described herein.