

P-Channel Enhancement-Mode MOSFET (-30V, -5.3A)

PRODUCT SUMMARY		
V_{DS}	I_D	$R_{DS(on)}$ (m Ω) Max
-30V	-5.3A	60 @ $V_{GS} = -10\text{V}$, $I_D = -5.3\text{A}$
		90 @ $V_{GS} = -4.5\text{V}$, $I_D = -4.2\text{A}$

Features

- Advanced Trench Process Technology
- High Density Cell Design for Ultra Low On-Resistance
- Fully Characterized Avalanche Voltage and Current
- Improved Shoot-Through FOM
- Ordering information : GS9435(Lead(Pb)-free and halogen-free)

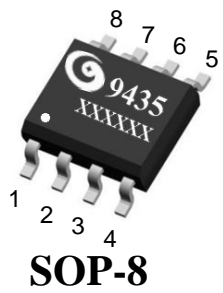
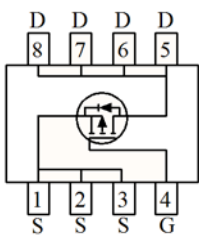

 <p>SOP-8</p>	<p>Pin 1 / 2 / 3: Source Pin 4: Gate Pin 5 / 6 / 7 / 8: Drain</p>	
--	---	--

Absolute Maximum Ratings ($T_A=25^\circ\text{C}$, unless otherwise noted)

Symbol	Parameter	Ratings	Units
V_{DS}	Drain-Source Voltage	-30	V
V_{GS}	Gate-Source Voltage	± 20	V
I_D	Drain Current (Continuous)	-5.3	A
I_{DM}^a	Drain Current (Pulsed)	-20	A
P_D	Total Power Dissipation @ $T_A=25^\circ\text{C}$	2.5	W
I_S	Maximum Diode Forward Current	-2.6	A
I_{AS}^c	Avalanche Current @ $L=0.1\text{mH}$	-12	A
E_{AS}^c	Avalanche energy @ $L=0.1\text{mH}$	7.2	mJ
T_j, T_{stg}	Operating Junction and Storage Temperature Range	-55 to +150	$^\circ\text{C}$
$R_{\theta JA}^b$	Thermal Resistance Junction to Ambient (PCB mounted)	50	$^\circ\text{C}/\text{W}$

Note: a: Repetitive Rating; Pulse width limited by the maximum junction temperature.

b: 1-in² 2oz Cu PCB board

c: Repetitive rating, pulse width limited by junction temperature $T_j=25^\circ\text{C}$

Electrical Characteristics (T_A=25°C, unless otherwise noted)

Symbol	Characteristic	Test Conditions	Min.	Typ.	Max.	Unit
• Off Characteristics						
BV _{DSS}	Drain-Source Breakdown Voltage	V _{GS} =0V, I _D =-250μA	-30	-	-	V
I _{DSS}	Zero Gate Voltage Drain Current	V _{DS} =-24V, V _{GS} =0V	-	-	-1	μA
I _{GSS}	Gate-Body Leakage Current	V _{GS} =±20V, V _{DS} =0V	-	-	±100	nA
• On Characteristics^d						
V _{GS(th)}	Gate Threshold Voltage	V _{DS} =V _{GS} , I _D =-250μA	-1	-	-3	V
R _{DS(on)}	Drain-Source On-State Resistance	V _{GS} =10V, I _D =-5.3A	-	50	60	mΩ
		V _{GS} =-4.5V, I _D =-4.2A	-	70	90	
g _{FS}	Forward Transconductance	V _{DS} =-10V, I _D =-5.3A	-	10	-	S
• Dynamic Characteristics^e						
C _{iss}	Input Capacitance	V _{DS} =-15V, V _{GS} =0V, f=1MHz	-	553	-	pF
C _{oss}	Output Capacitance		-	93	-	
C _{rss}	Reverse Transfer Capacitance		-	63	-	
• Switching Characteristics^e						
Q _g	Total Gate Charge	V _{DS} =-15V, I _D =-5.3A, V _{GS} =-10V	-	9.86	-	nC
Q _{gs}	Gate-Source Charge		-	3.65	-	
Q _{gd}	Gate-Drain Charge		-	1.92	-	
t _{d(on)}	Turn-on Delay Time	V _{DD} =-15V, R _L =5Ω, I _D =-3A, V _{GS} =-10V, R _{GEN} =6Ω	-	11.0	-	nS
t _r	Turn-on Rise Time		-	2.85	-	
t _{d(off)}	Turn-off Delay Time		-	23.05	-	
t _f	Turn-off Fall Time		-	3.19	-	
• Drain-Source Diode Characteristics						
V _{SD}	Drain-Source Diode Forward Voltage	V _{GS} =0V, I _S =-2.6A	-	-	-1.3	V

Note: d:Pulse Test: Pulse Width ≤300us, Duty Cycle≤2%

e: Guaranteed by design, not subject to production testing.

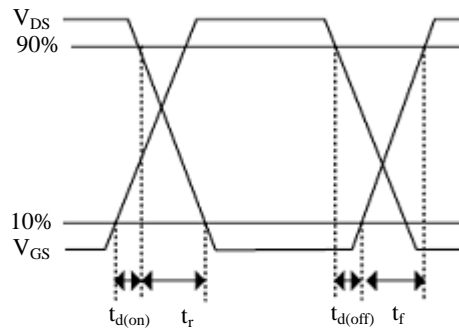
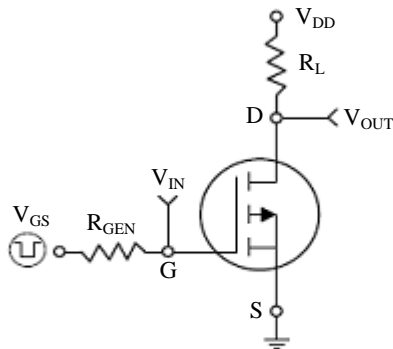

Switching Test Circuit and Switching Waveforms

Characteristics Curve

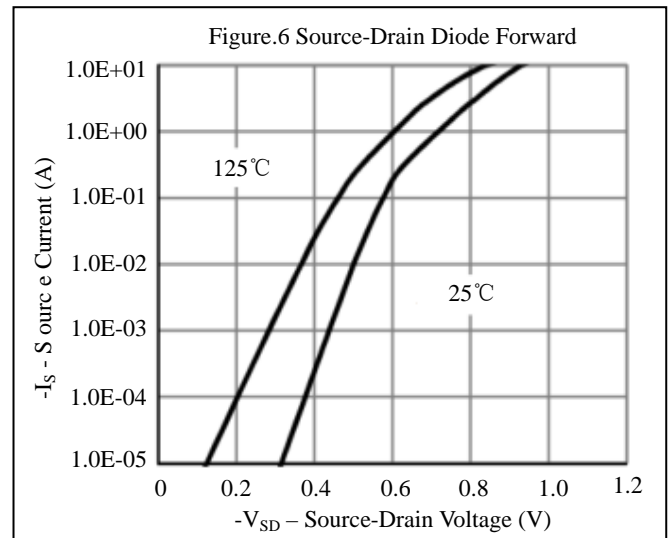
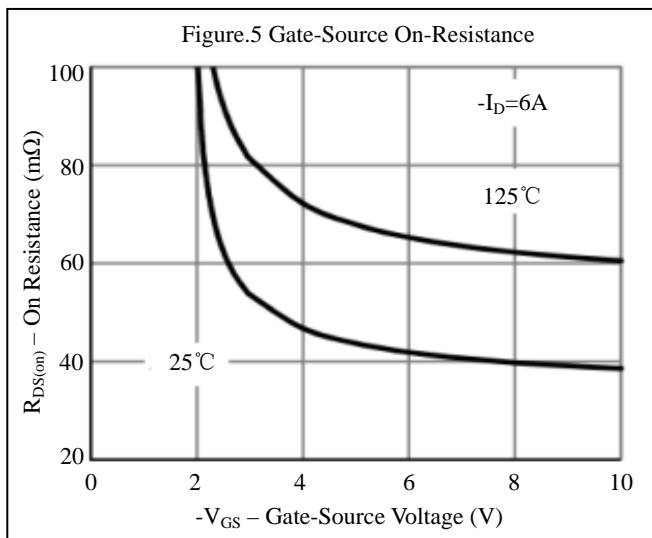
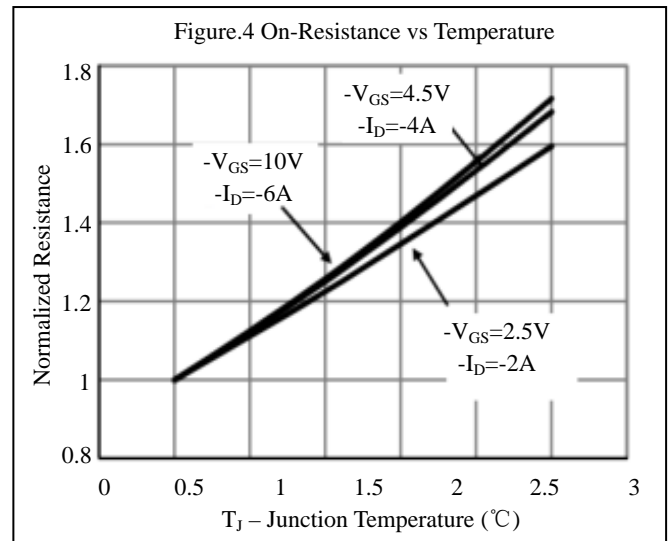
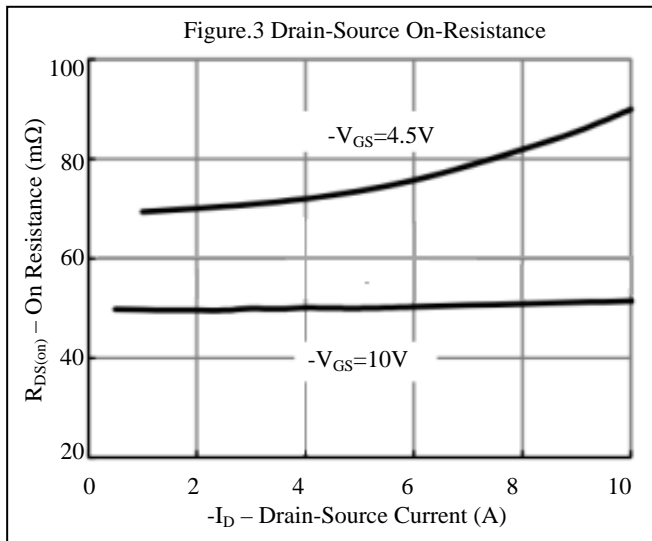
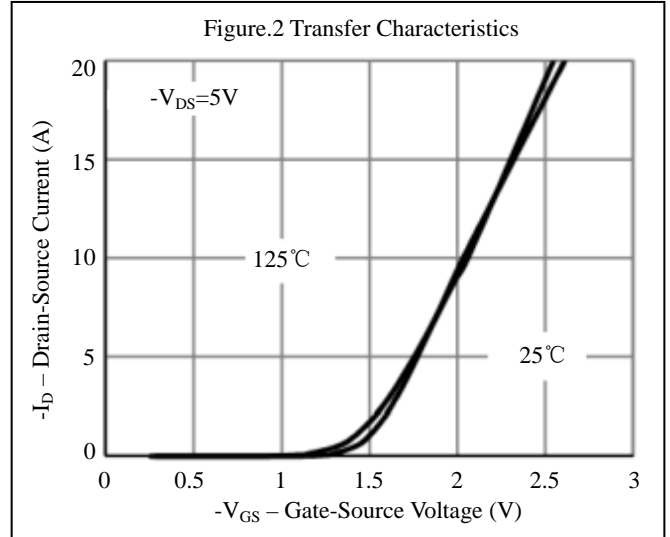
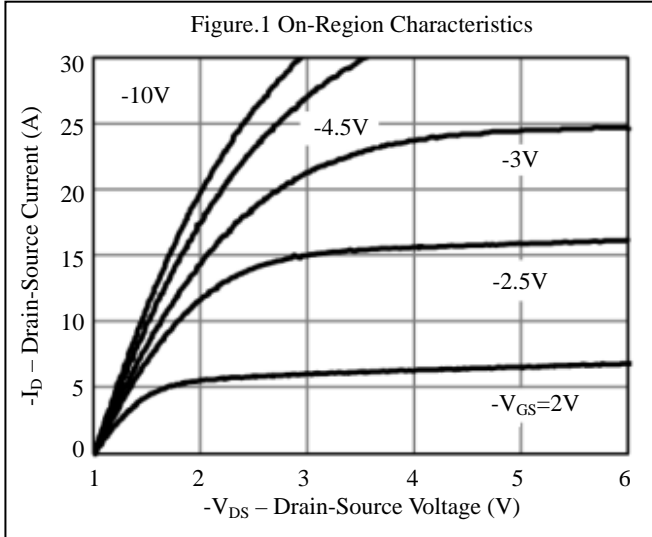

Characteristics Curve

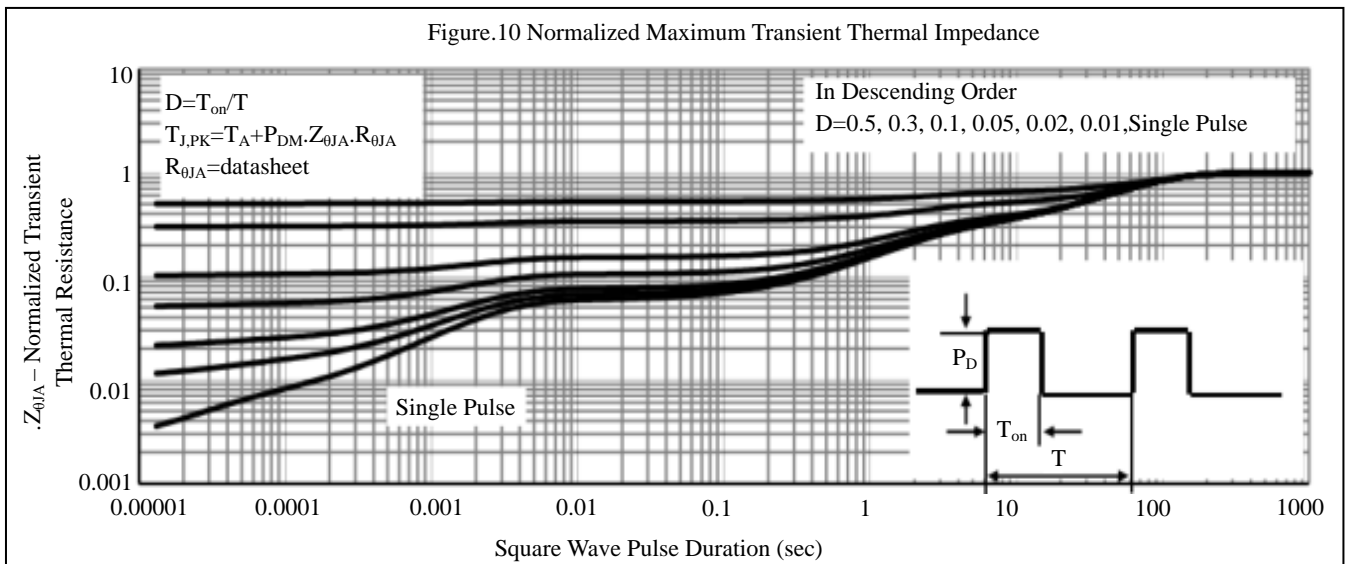
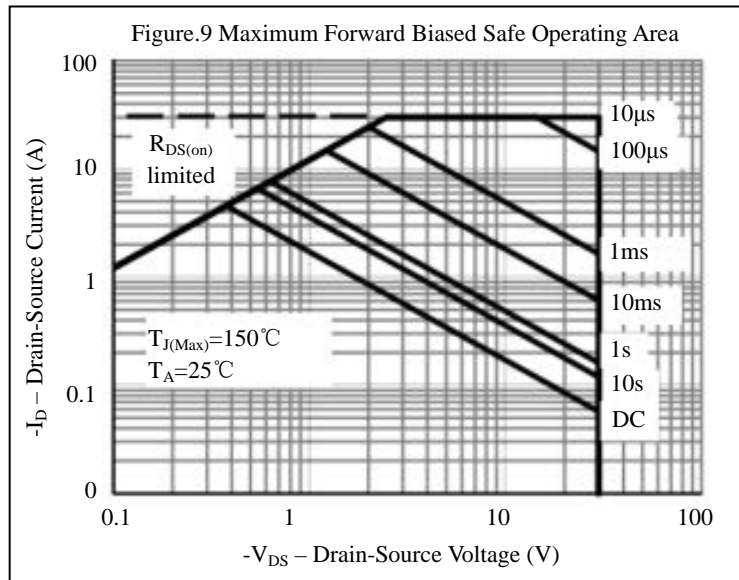
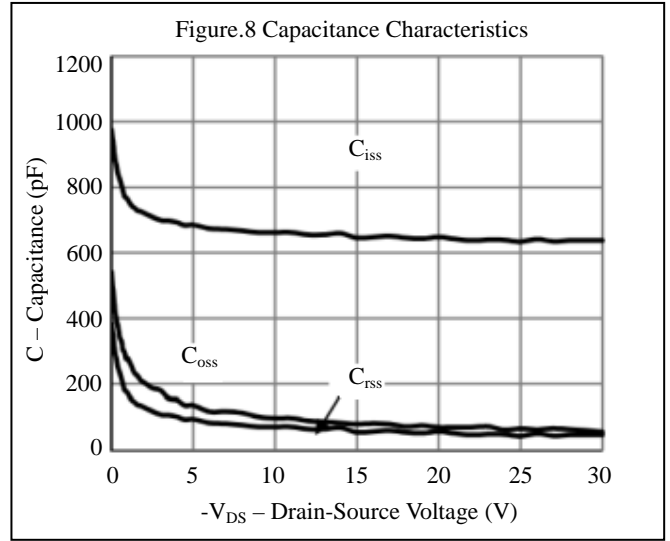
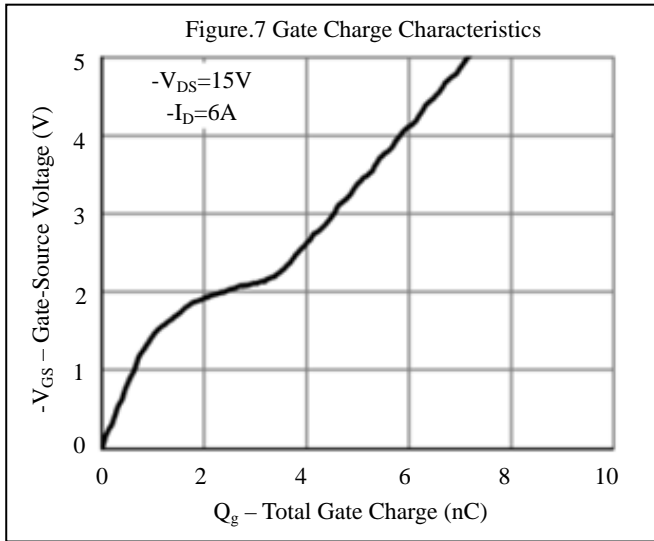

SOP-8 PACKAGE OUTLINE DIMENSIONS

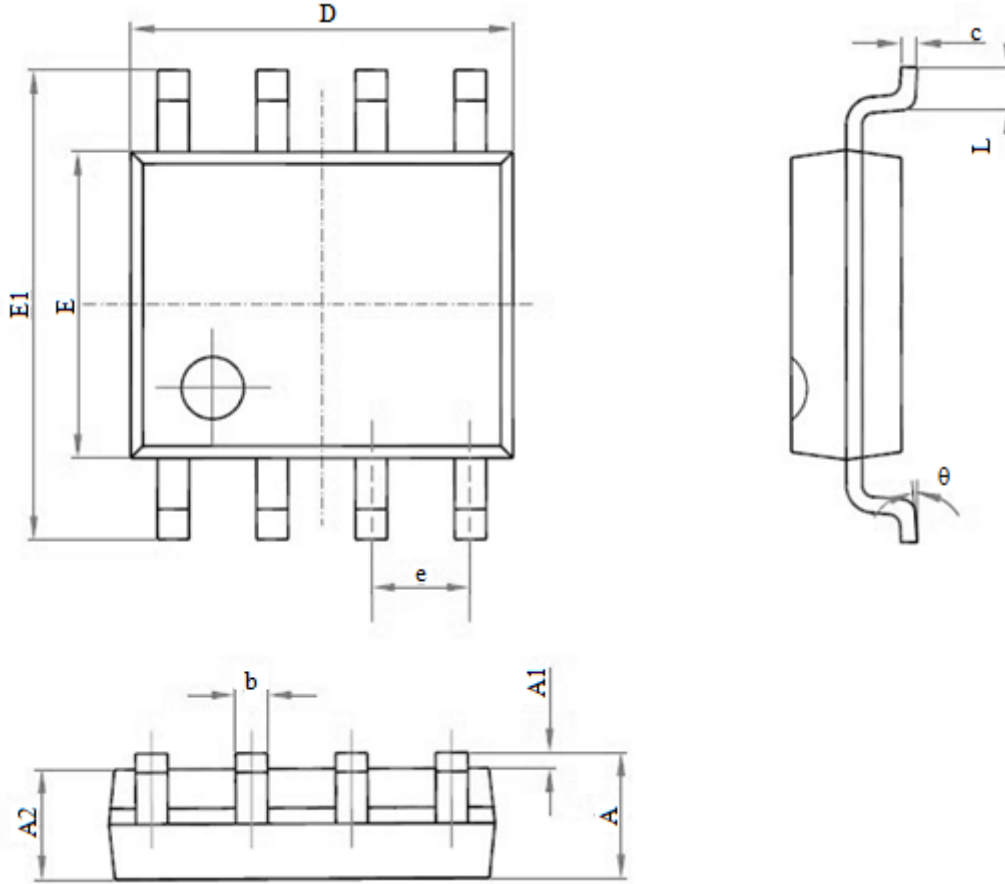

Symbol	Dimensions In Millimeters (MM)		Dimensions In Inches (MIL)	
	Min	Max	Min	Max
A	1.350	1.750	0.053	0.069
A1	0.100	0.250	0.004	0.010
A2	1.350	1.550	0.053	0.061
b	0.310	0.510	0.013	0.020
c	0.170	0.250	0.006	0.010
D	4.700	5.100	0.185	0.200
E	3.800	4.000	0.150	0.157
E1	5.800	6.200	0.228	0.244
e	1.270(BSC)		0.050(BSC)	
L	0.400	1.270	0.016	0.050
theta	0°	8°	0°	8°



Notice

1. Specification of the products displayed herein is subject to change without notice. Continuous development may necessitate changes in technical data without notice. GEMMICRO or anyone on its behalf assumes no responsibility or liability for any errors or inaccuracies.

2. Stresses beyond those listed under “Absolute Maximum Ratings” may cause permanent damage to the device. These are stress ratings only and functional operation of the device at these or any other conditions beyond those indicated in the operational sections of the specifications are not implied. Exposure to absolute maximum rating conditions for extended periods may affect device reliability.