

## Dual N-Channel High Density Trench MOSFET (20V, 6.0A)

### PRODUCT SUMMARY

$V_{DS}$	$I_D$	$R_{DS(on)}$ (m-ohm) Max
20V	6.0A	24 @ $V_{GS} = 4.0V, I_D=6.0A$
		30 @ $V_{GS} = 2.5V, I_D=4.3A$

### Features

- Advanced Trench Process Technology
- High Density Cell Design for Ultra Low On-Resistance
- Rugged and reliable
- Surface Mount package.
- Ordering information : GC6820 (Lead (Pb) -free)  
GC6820-G (Lead (Pb) -free and halogen-free)

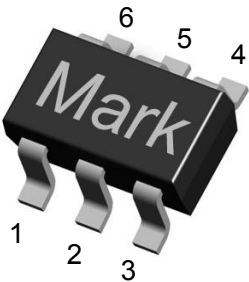

**GC6820 Pin Assignment & Symbol**

6-Lead Plastic **SOT-23-6L**  
Pin 1:G1 2: S2 3: G2  
4: D2 5: S1 6: D1

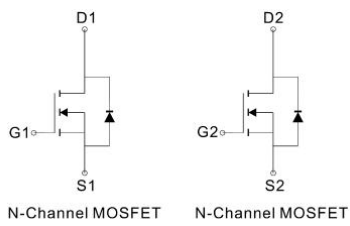

### Absolute Maximum Ratings ( $T_A=25^\circ C$ , unless otherwise noted)

Symbol	Parameter	Ratings	Units
$V_{DS}$	Drain-Source Voltage	20	V
$V_{GS}$	Gate-Source Voltage	$\pm 12$	V
$I_D$	Drain Current (Continuous)	6	A
$I_{DM}$	Drain Current (Pulsed) <sup>a</sup>	20	A
$P_D$	Maximum Power Dissipation <sup>a</sup> @ $T_A=25^\circ C$	1.25	W
$I_S$	Maximum Diode Forward Current	1.7	A
$T_j, T_{stg}$	Operating Junction and Storage Temperature Range	-55 to +150	$^\circ C$
$R_{\theta JA}$	Thermal Resistance Junction to Ambient (PCB mounted) <sup>b</sup>	100	$^\circ C/W$

a: Repetitive Rating: Pulse width limited by the maximum junction temperature.  
b: 1-in<sup>2</sup> 2oz Cu PCB board

## Electrical Characteristics (T<sub>A</sub>=25°C, unless otherwise noted)

Symbol	Characteristic	Test Conditions	Min.	Typ.	Max.	Unit
<b>• Off Characteristics</b>						
BV <sub>DSS</sub>	Drain-Source Breakdown Voltage	V <sub>GS</sub> =0V, I <sub>D</sub> =250uA	20	-	-	V
I <sub>DSS</sub>	Zero Gate Voltage Drain Current	V <sub>DS</sub> =20V, V <sub>GS</sub> =0V	-	-	1	uA
I <sub>GSS</sub>	Gate-Body Leakage Current	V <sub>GS</sub> =±12V, V <sub>DS</sub> =0V	-	-	±100	nA
<b>• On Characteristics</b>						
V <sub>GS(th)</sub>	Gate Threshold Voltage	V <sub>DS</sub> =V <sub>GS</sub> , I <sub>D</sub> =250uA	0.6	0.67	1.2	V
R <sub>DS(on)</sub>	Drain-Source On-State Resistance	V <sub>GS</sub> =4.0V, I <sub>D</sub> =6.0A	-	21	24	mΩ
		V <sub>GS</sub> =2.5V, I <sub>D</sub> =4.3A	-	25	30	
<b>• Dynamic Characteristics</b>						
C <sub>iss</sub>	Input Capacitance	V <sub>DS</sub> =8V, V <sub>GS</sub> =0V, f=1MHz	-	560	-	PF
C <sub>oss</sub>	Output Capacitance		-	170	-	
C <sub>rss</sub>	Reverse Transfer Capacitance		-	140	-	
<b>• Switching Characteristics</b>						
Q <sub>g</sub>	Total Gate Charge	V <sub>DS</sub> =10V, I <sub>D</sub> =3.0A, V <sub>GS</sub> =4.5V	-	5	-	nC
Q <sub>gs</sub>	Gate-Source Charge		-	0.9	-	
Q <sub>gd</sub>	Gate-Drain Charge		-	1.4	-	
t <sub>d(on)</sub>	Turn-on Delay Time	V <sub>DD</sub> =10V, R <sub>L</sub> =10Ω, I <sub>D</sub> =1A, V <sub>GEN</sub> =4.5V, R <sub>G</sub> =6Ω	-	5.9	-	nS
t <sub>r</sub>	Turn-on Rise Time		-	7.45	-	
t <sub>d(off)</sub>	Turn-off Delay Time		-	16	-	
t <sub>f</sub>	Turn-off Fall Time		-	3.96	-	
<b>• Drain-Source Diode Characteristics</b>						
V <sub>SD</sub>	Drain-Source Diode Forward Voltage	V <sub>GS</sub> =0V, I <sub>S</sub> =1.7A	-	-	1.2	V

Note: Pulse Test: Pulse Width ≤300us, Duty Cycle≤2%

## Characteristics Curve

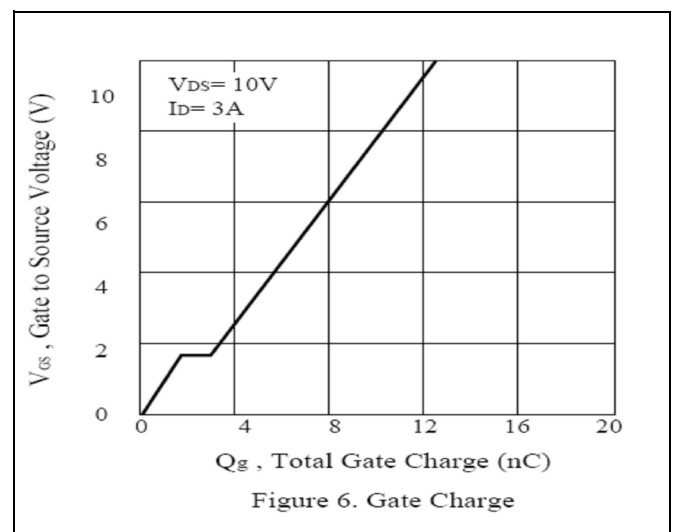
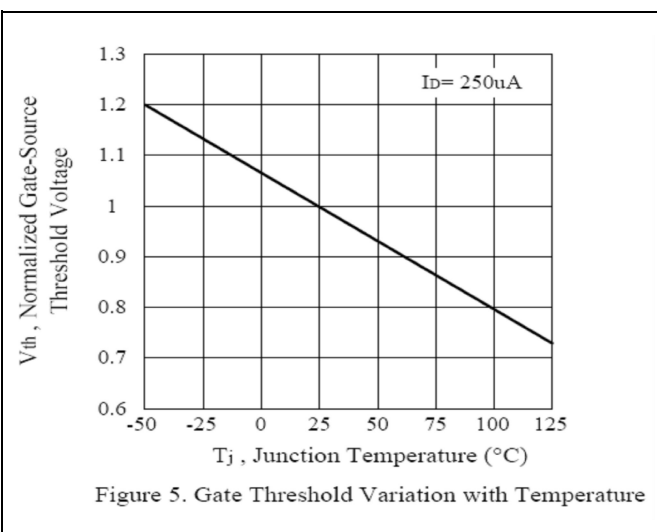
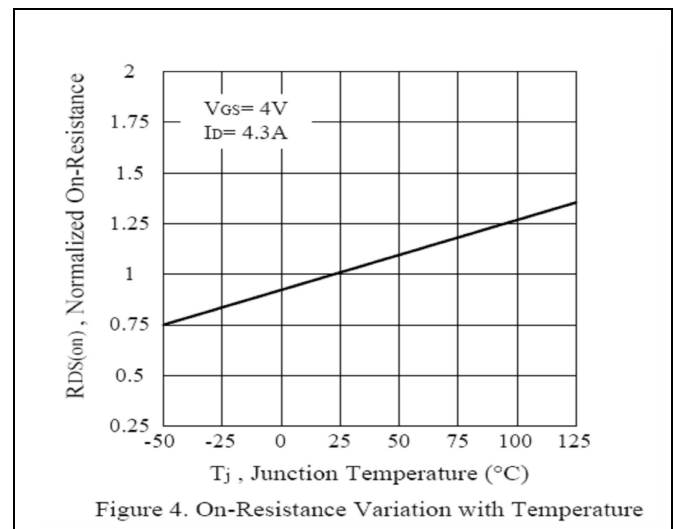
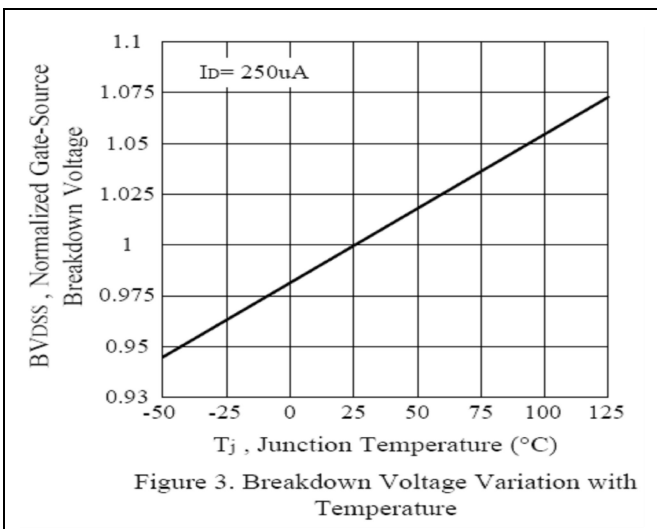
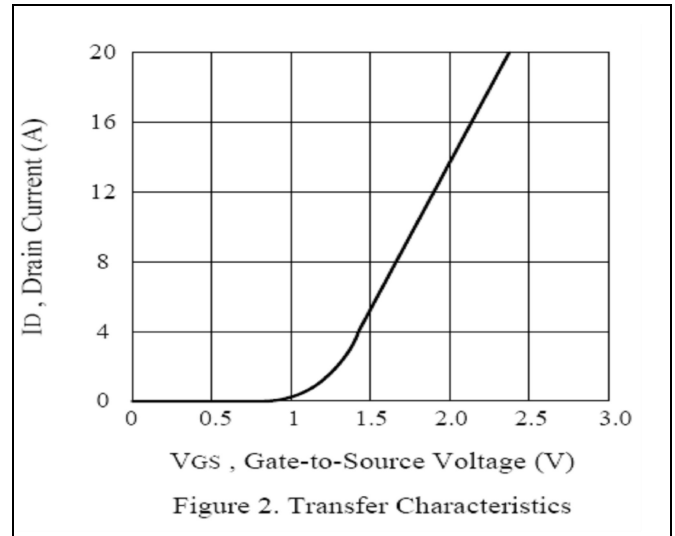
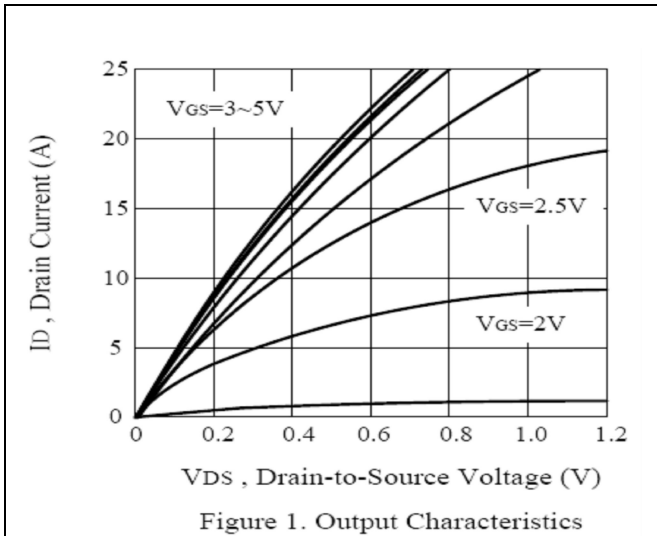

## Characteristics Curve

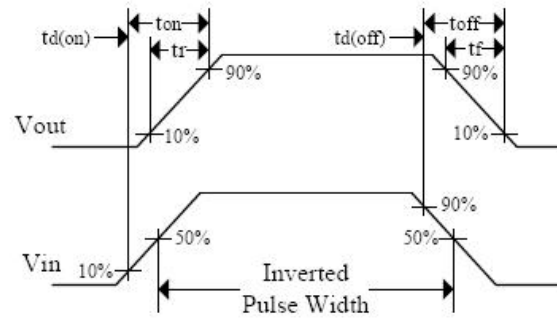
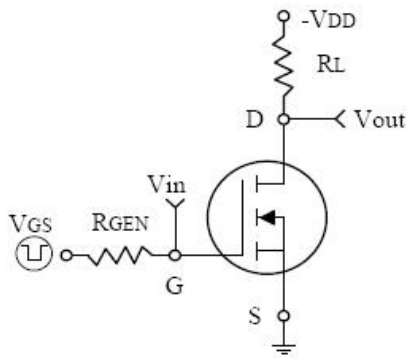
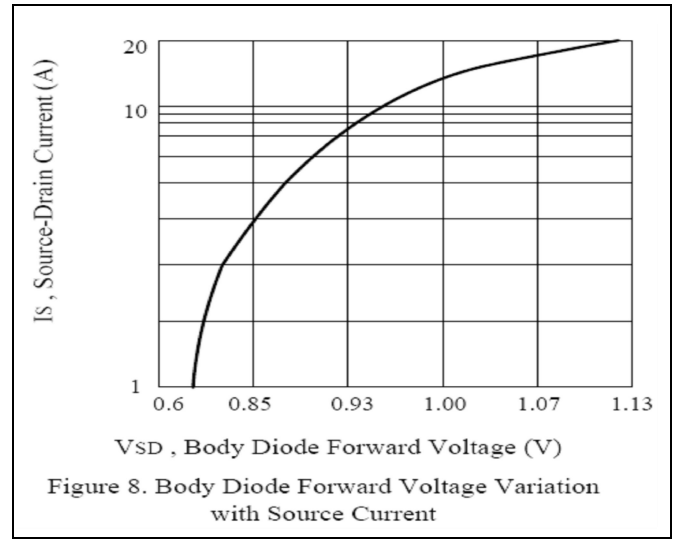
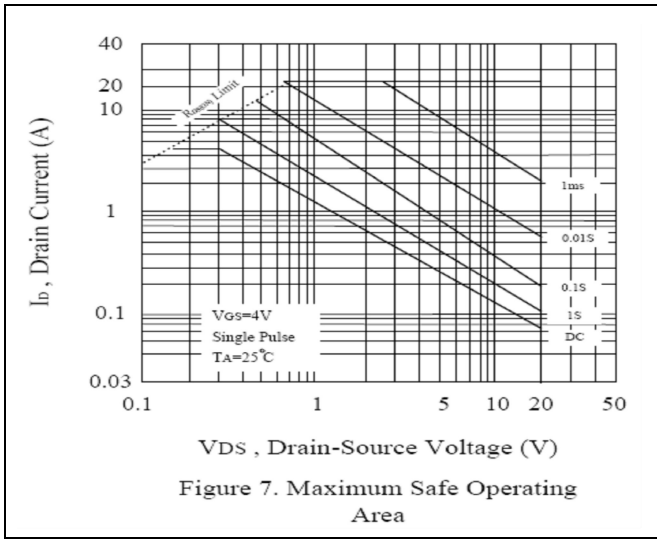

Switching Test Circuit and Switching Waveforms

## SOT-23-6L PACKAGE OUTLINE DIMENSIONS

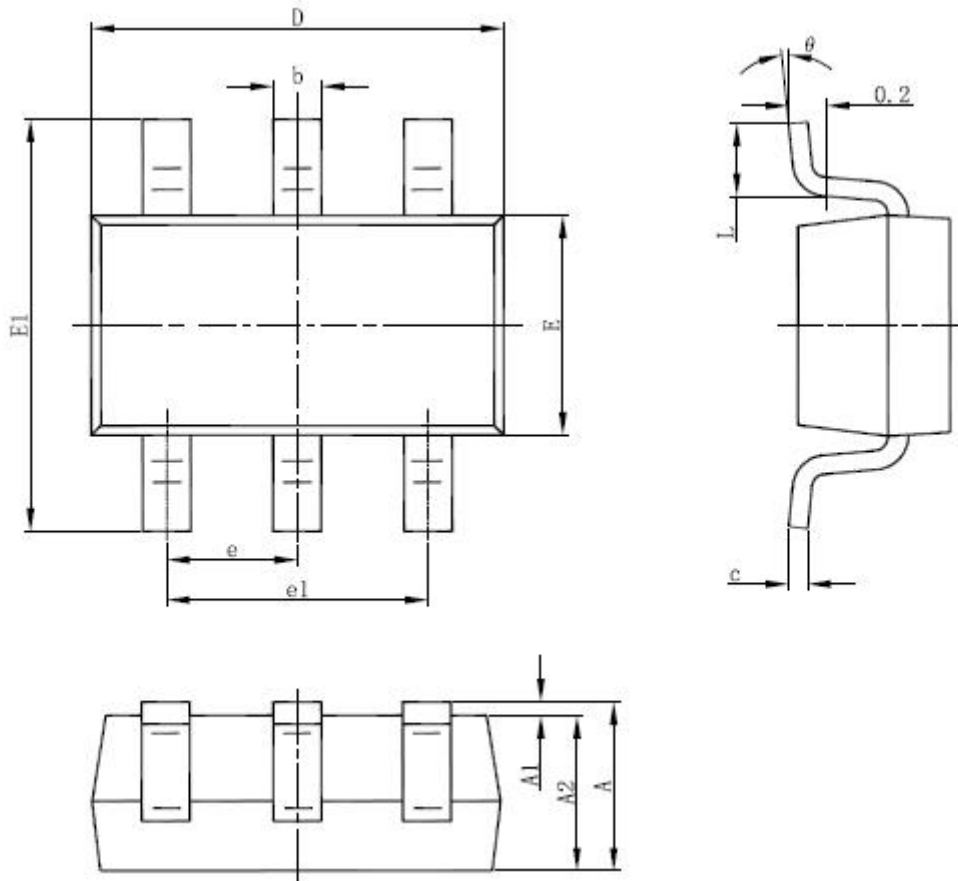

Symbol	Dimensions In Millimeters		Dimensions In Inches	
	Min	Max	Min	Max
A	1.050	1.250	0.041	0.049
A1	0.000	0.100	0.000	0.004
A2	1.050	1.150	0.041	0.045
b	0.300	0.500	0.012	0.020
c	0.100	0.200	0.004	0.008
D	2.820	3.020	0.111	0.119
E	1.500	1.700	0.059	0.067
E1	2.650	2.950	0.104	0.116
e	0.950(BSC)		0.037(BSC)	
e1	1.800	2.000	0.071	0.079
L	0.300	0.600	0.012	0.024
theta	0°	8°	0°	8°



**Notice**

1. Specification of the products displayed herein is subject to change without notice. Continuous development may necessitate changes in technical data without notice. GEMMICRO or anyone on its behalf assumes no responsibility or liability for any errors or inaccuracies.

2. Stresses beyond those listed under “Absolute Maximum Ratings” may cause permanent damage to the device. These are stress ratings only and functional operation of the device at these or any other conditions beyond those indicated in the operational sections of the specifications are not implied. Exposure to absolute maximum rating conditions for extended periods may affect device reliability.