

NCP81158

Synchronous Buck MOSFET Driver

The NCP81158 is a high-performance dual MOSFET gate driver in a small 3 mm x 3 mm package, optimized to drive the gates of both high-side and low-side power MOSFETs in a synchronous buck converter. The driver outputs can be placed into a high-impedance state via the tri-state PWM and EN inputs. The NCP81158 comes packaged with an integrated boost diode to minimize external components. A VCC UVLO function guarantees the outputs are low when the supply voltage is low.

Features

- Space-efficient 3 mm x 3 mm DFN8 thermally-enhanced Package
- VCC Range of 4.5 V to 5.5 V
- Internal Bootstrap Diode
- 5 V 3-stage PWM Input
- Diode Braking Capability via EN Mid-state
- Adaptive Anti-cross Conduction Circuit Protects Against Cross-conduction during FET Turn-on and Turn-off
- Output Disable Control Turns Off Both MOSFETs via Enable Pin
- VCC Undervoltage Lockout
- These Devices are Pb-free, Halogen-free/BFR-free and are RoHS Compliant

Typical Applications

- Power Solutions for Notebook and Desktop Systems



ON Semiconductor®

www.onsemi.com



DFN8
CASE 506BJ

MARKING DIAGRAM

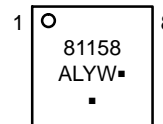

81158 = Specific Device Code
A = Assembly Location
L = Wafer Lot
Y = Year
W = Work Week
▪ = Pb-Free Package

(Note: Microdot may be in either location)

PINOUT DIAGRAM

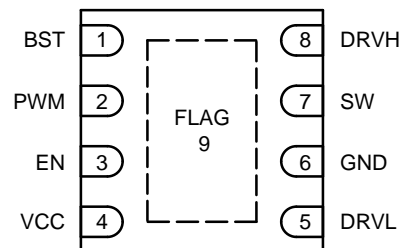

ORDERING INFORMATION

Device	Package	Shipping†
NCP81158MNTXG	DFN8 (Pb-Free)	3000 / Tape & Reel

†For information on tape and reel specifications, including part orientation and tape sizes, please refer to our Tape and Reel Packaging Specifications Brochure, BRD8011/D.

NCP81158

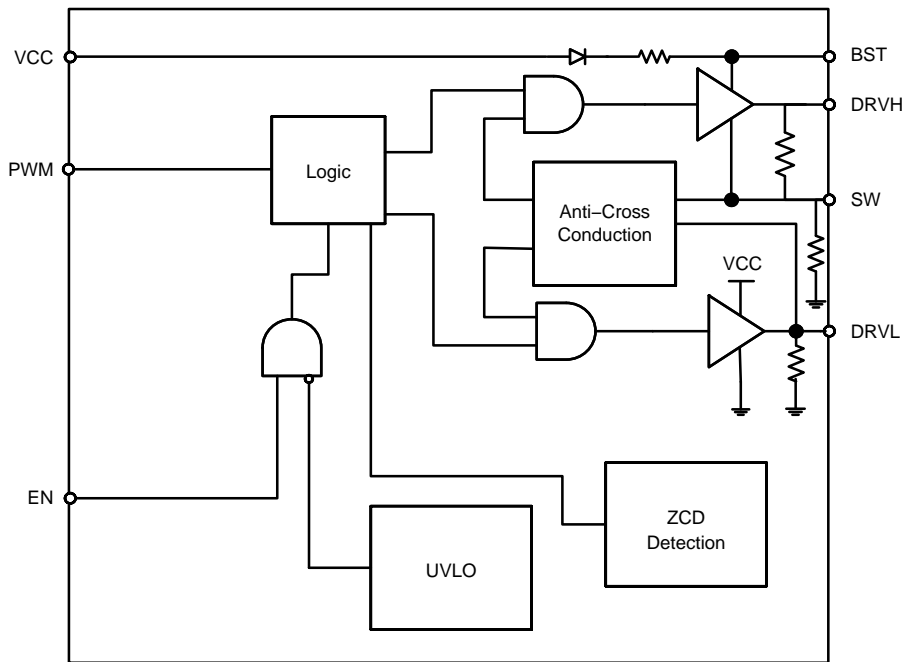

Figure 1. Block Diagram

PIN DESCRIPTIONS

Pin No.	Symbol	Description
1	BST	Floating bootstrap supply pin for high side gate driver. Connect the bootstrap capacitor between this pin and the SW pin.
2	PWM	Control input. The PWM signal has three distinctive states: Low = Low Side FET Enabled, Mid = Diode Emulation Enabled, High = High Side FET Enabled.
3	EN	Logic input. A logic high to enable the part and a logic low to disable the part. Three states logic input: EN = High to enable the gate driver; EN = Low to disable the driver; EN = Mid to go into diode mode (both high and low side gate drive signals are low)
4	VCC	Power supply input. Connect a bypass capacitor (0.1 μ F) from this pin to ground.
5	DRVL	Low side gate drive output. Connect to the gate of low side MOSFET.
6	GND	Bias and reference ground. All signals are referenced to this node.
7	SW	Switch node. Connect this pin to the source of the high side MOSFET and drain of the low side MOSFET.
8	DRVH	High side gate drive output. Connect to the gate of high side MOSFET.
9	FLAG	Thermal flag. There is no electrical connection to the IC. Connect to ground plane.

NCP81158

ABSOLUTE MAXIMUM RATINGS

ELECTRICAL INFORMATION

Symbol	Pin Name	V _{MAX}	V _{MIN}
V _{CC}	Main Supply Voltage Input	6.5 V 7.5 V < 80 ns	-0.3 V
BST	Bootstrap Supply Voltage	35 V wrt/ GND 40 V ≤ 50 ns wrt/ GND 6.5 V wrt/ SW 7.7 V < 50 ns wrt/ SW	-0.3 V wrt/SW
SW	Switching Node (Bootstrap Supply Return)	35 V 40 V ≤ 80 ns	-5 V -10 V (200 ns)
DRVH	High Side Driver Output	BST + 0.3 V SW + 7 V (< 80 ns)	-0.3 V wrt/SW -2 V (< 200 ns) wrt/SW
DRVL	Low Side Driver Output	V _{CC} + 0.3 V 7 V (< 80 ns)	-0.3 V DC -5 V (< 200 ns)
PWM	DRVH and DRVL Control Input	6.5 V	-0.3 V
EN	Enable Pin	6.5 V	-0.3 V
GND	Ground	0 V	0 V

Stresses exceeding those listed in the Maximum Ratings table may damage the device. If any of these limits are exceeded, device functionality should not be assumed, damage may occur and reliability may be affected.

*All signals referenced to AGND unless noted otherwise.

THERMAL INFORMATION

Symbol	Parameter	Value	Unit
R _{θJA}	Thermal Characteristic QFN Package (Note 1)	119	°C/W
T _J	Operating Junction Temperature Range (Note 2)	-40 to 150	°C
T _A	Operating Ambient Temperature Range	-40 to +100	°C
T _{STG}	Maximum Storage Temperature Range	-55 to +150	°C
MSL	Moisture Sensitivity Level – QFN Package	1	

*The maximum package power dissipation must be observed.

- 1 in² Cu, 1 oz. thickness.
- JESD 51-7 (1S2P Direct-Attach Method) with 1 LFM.

NCP81158 ELECTRICAL CHARACTERISTICS (-40°C < T_A < +100°C; 4.5 V < V_{CC} < 5.5 V, 4.5 V < BST-SWN < 5.5 V, 4.5 V < BST < 30 V, 0 V < SWN < 21 V, unless otherwise noted)

Parameter	Test Conditions	Min	Typ	Max	Unit
-----------	-----------------	-----	-----	-----	------

SUPPLY VOLTAGE

VCC Operation Voltage		4.5		5.5	V
-----------------------	--	-----	--	-----	---

UNDERVOLTAGE LOCKOUT

VCC Start Threshold		3.8	4.35	4.5	V
VCC UVLO Hysteresis		150	200	250	mV

SUPPLY CURRENT

Shutdown Mode	I _{CC} + I _{BST} , EN = GND		1.0	2.0	μA
Normal Mode	I _{CC} + I _{BST} , EN = 5 V, PWM = OSC		4.7		mA
Standby Current	I _{CC} + I _{BST} , EN = HIGH, PWM = LOW, No loading on DRVH & DRVL		0.9		mA
Standby Current	I _{CC} + I _{BST} , EN = HIGH, PWM = HIGH, No loading on DRVH & DRVL		1.1		mA

BOOTSTRAP DIODE

Forward Voltage	V _{CC} = 5 V, forward bias current = 2 mA	0.1	0.4	0.6	V
-----------------	--	-----	-----	-----	---

NCP81158

NCP81158 ELECTRICAL CHARACTERISTICS ($-40^{\circ}\text{C} < T_A < +100^{\circ}\text{C}$; $4.5\text{ V} < V_{CC} < 5.5\text{ V}$, $4.5\text{ V} < \text{BST-SWN} < 5.5\text{ V}$, $4.5\text{ V} < \text{BST} < 30\text{ V}$, $0\text{ V} < \text{SWN} < 21\text{ V}$, unless otherwise noted)

Parameter	Test Conditions	Min	Typ	Max	Unit
-----------	-----------------	-----	-----	-----	------

PWM INPUT

PWM Input High		3.4			V
PWM Mid-State		1.3		2.7	V
PWM Input Low				0.7	V
ZCD Blanking Timer			350		ns

HIGH SIDE DRIVER

Output Impedance, Sourcing Current	$V_{\text{BST}} - V_{\text{SW}} = 5\text{ V}$		0.9	1.7	Ω
Output Impedance, Sinking Current	$V_{\text{BST}} - V_{\text{SW}} = 5\text{ V}$		0.7	1.7	Ω
DRVH Rise Time t_{rDRVH}	$V_{\text{CC}} = 5\text{ V}$, 3 nF load, $V_{\text{BST}} - V_{\text{SW}} = 5\text{ V}$		16	25	ns
DRVH Fall Time t_{fDRVH}	$V_{\text{CC}} = 5\text{ V}$, 3 nF load, $V_{\text{BST}} - V_{\text{SW}} = 5\text{ V}$		11	18	ns
DRVH Turn-Off Propagation Delay t_{pdDRVH}	$C_{\text{LOAD}} = 3\text{ nF}$	10		30	ns
DRVH Turn-On Propagation Delay t_{pdhDRVH}	$C_{\text{LOAD}} = 3\text{ nF}$	10		40	ns
SW Pulldown Resistance	SW to PGND		45		k Ω
DRVH Pulldown Resistance	DRVH to SW, $\text{BST-SW} = 0\text{ V}$		45		k Ω

LOW SIDE DRIVER

Output Impedance, Sourcing Current			0.9	1.7	Ω
Output Impedance, Sinking Current			0.4	0.8	Ω
DRVH Rise Time t_{rDRVH}	$C_{\text{LOAD}} = 3\text{ nF}$		16	25	ns
DRVH Fall Time t_{fDRVH}	$C_{\text{LOAD}} = 3\text{ nF}$		11	15	ns
DRVH Turn-Off Propagation Delay t_{pdDRVH}	$C_{\text{LOAD}} = 3\text{ nF}$	10		30	ns
DRVH Turn-On Propagation Delay t_{pdhDRVH}	$C_{\text{LOAD}} = 3\text{ nF}$	5.0		25	ns
DRVH Pulldown Resistance	DRVH to PGND, $V_{\text{CC}} = \text{PGND}$		45		k Ω

EN INPUT

Input Voltage High		3.3			V
Input Voltage Mid		1.35		1.8	V
Input Voltage Low				0.6	V
Input bias current		-1.0		1.0	μA
Propagation Delay Time			20	40	ns

SW NODE

SW Node Leakage Current				20	μA
Zero Cross Detection Threshold Voltage			-6.0		mV

Product parametric performance is indicated in the Electrical Characteristics for the listed test conditions, unless otherwise noted. Product performance may not be indicated by the Electrical Characteristics if operated under different conditions.

Table 1. DECODER TRUTH TABLE

Input	ZCD	DRVH	DRVH
PWM High (Enable High)	ZCD Reset	Low	High
PWM Mid (Enable High)	Positive Current Through the Inductor	High	Low
PWM Mid (Enable High)	Zero Current Through the Inductor	Low	Low
PWM Low (Enable High)	ZCD Reset	High	Low
Enable at Mid	X	Low	Low

NCP81158

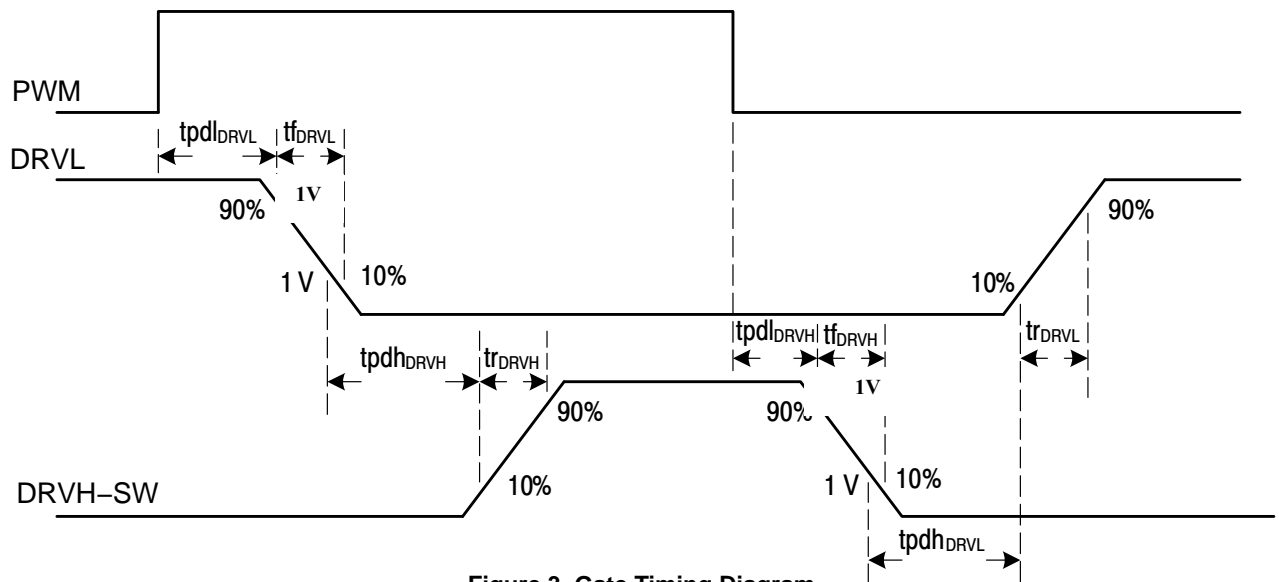

Figure 3. Gate Timing Diagram

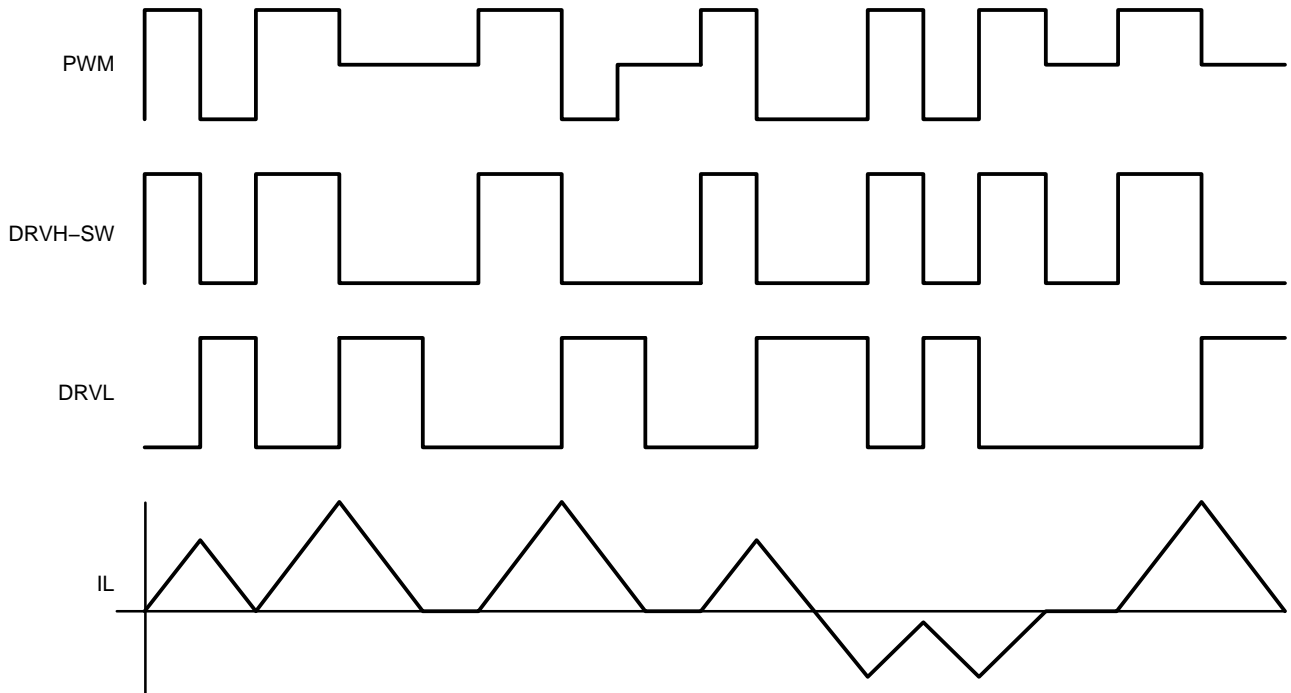

Figure 4. Timing Diagram

APPLICATION INFORMATION

The NCP81158 gate driver is a single-phase MOSFET driver designed for driving N-channel MOSFETs in a synchronous buck converter topology.

Low-Side Driver

The low-side driver is designed to drive a ground-referenced low- $R_{DS(on)}$ N-channel MOSFET. The voltage supply for the low-side driver is internally connected to the VCC and GND pins.

High-Side Driver

The high-side driver is designed to drive a floating low- $R_{DS(on)}$ N-channel MOSFET. The gate voltage for the high-side driver is developed by a bootstrap circuit referenced to the SW pin.

The bootstrap circuit is comprised of the integrated diode and an external bootstrap capacitor. When the NCP81158 is starting up, the SW pin is held at ground, allowing the

bootstrap capacitor to charge up to VCC through the bootstrap diode. When the PWM input is driven high, the high-side driver will turn on the high-side MOSFET using the stored charge of the bootstrap capacitor. As the high-side MOSFET turns on, the SW pin rises. When the high-side MOSFET is fully turned on, SW will settle to VIN and BST will settle to VIN + VCC (excluding parasitic ringing).

Bootstrap Circuit

The bootstrap circuit relies on an external charge storage capacitor (C_{BST}) and an integrated diode to provide current to the high-side driver. A multi-layer ceramic capacitor (MLCC) with a value greater than 100 nF should be used for C_{BST}.

Power Supply Decoupling

The NCP81158 can source and sink relatively large currents to the gate pins of the MOSFETs. In order to maintain a constant and stable supply voltage, a low-ESR capacitor should be placed near the VCC and GND pins. A MLCC between 1 µF and 4.7 µF is typically used.

Undervoltage Lockout

DRVH and DRVL are low until VCC reaches the VCC UVLO threshold, typically 4.35 V. Once VCC reaches this threshold, the PWM signal will control DRVH and DRVL. There is a 200 mV hysteresis on VCC UVLO. There are pull-down resistors on DRVH, DRVL and SW to prevent the gates of the MOSFETs from accumulating enough charge to turn on when the driver is powered off.

Three-State EN Input

Placing EN into a logic-high and logic-low will turn the driver on and off, respectively, as long as VCC is greater than the UVLO threshold. The EN threshold limits are specified in the electrical characteristics table in this datasheet. Setting the voltage on EN to a mid-state level will pull both DRVH and DRVL low.

Setting EN to the mid-state level can be used for body diode braking to quickly reduce the inductor current. By turning the LS FET off and having the current conduct through the LS FET body diode, the voltage at the switch node will be at a greater negative potential compared to having the LS FET on. This greater negative potential on switch node allows there to be a greater voltage across the output inductor, since the opposite terminal of the inductor is connected to the converter output voltage. The larger voltage across the inductor causes there to be a greater inductor current slew rate, allowing the current to decrease at a faster rate.

Three-State PWM Input

Switching PWM between logic-high and logic-low states will allow the driver to operate in continuous conduction

mode as long as VCC is greater than the UVLO threshold and EN is high. The threshold limits are specified in the electrical characteristics table in this datasheet. Refer to Figure 21 for the gate timing diagrams and Table 1 for the EN/PWM logic table.

When PWM is set above PWM_{HI}, DRVL will first turn off after a propagation delay of t_{pd}DRVL. To ensure non-overlap between DRVL and DRVH, there is a delay of t_{pd}DRVH from the time DRVL falls to 1 V, before DRVH is allowed to turn on.

When PWM falls below PWM_{LO}, DRVH will first turn off after a propagation delay of t_{pd}DRVH. To ensure non-overlap between DRVH and DRVL, there is a delay of t_{pd}DRVL from the time DRVH – SW falls to 1 V, before DRVL is allowed to turn on.

When PWM enters the mid-state voltage range, DRVL goes high after the non-overlap delay, and stays high for the duration of the ZCD blanking + debounce timers. Once these timers expire, SW is monitored for zero current detection and pulls DRVL low once zero current is detected.

Thermal Considerations

As power in the NCP81158 increases, it might become necessary to provide some thermal relief. The maximum power dissipation supported by the device is dependent upon board design and layout. Mounting pad configuration on the PCB, the board material, and the ambient temperature affect the rate of junction temperature rise for the part. When the NCP81158 has good thermal conductivity through the PCB, the junction temperature will be relatively low with high power applications. The maximum dissipation the NCP81158 can handle is given by:

$$P_{D(MAX)} = \frac{[T_{J(MAX)} - T_A]}{R_{\theta JA}} \quad (\text{eq. 1})$$

Since T_J is not recommended to exceed 150°C, the NCP81158, soldered on to a 645 mm² copper area, using 1 oz. copper and FR4, can dissipate up to 1.05 W when the ambient temperature (T_A) is 25°C. The power dissipated by the NCP81158 can be calculated from the following equation:

$$P_D \approx VCC \cdot [(n_{HS} \cdot Q_{gHS} + n_{LS} \cdot Q_{gLS}) \cdot f + I_{standby}] \quad (\text{eq. 2})$$

Where n_{HS} and n_{LS} are the number of high-side and low-side FETs, respectively, Q_{gHS} and Q_{gLS} are the gate charges of the high-side and low-side FETs, respectively and f is the switching frequency of the converter.

MECHANICAL CASE OUTLINE

PACKAGE DIMENSIONS

ON Semiconductor®



SCALE 2:1

DFN8 3x3, 0.5P
CASE 506BJ-01
ISSUE O

DATE 08 NOV 2007

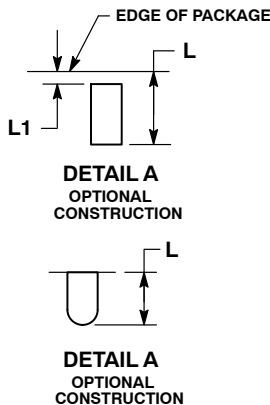

- NOTES:
1. DIMENSIONS AND TOLERANCING PER ASME Y14.5M, 1994.
 2. CONTROLLING DIMENSION: MILLIMETERS.
 3. DIMENSION b APPLIES TO PLATED TERMINAL AND IS MEASURED BETWEEN 0.15 AND 0.30 MM FROM TERMINAL.
 4. COPLANARITY APPLIES TO THE EXPOSED PAD AS WELL AS THE TERMINALS.

MILLIMETERS		
DIM	MIN	MAX
A	0.80	1.00
A1	0.00	0.05
A3	0.20	REF
b	0.18	0.30
D	3.00	BSC
D2	1.64	1.84
E	3.00	BSC
E2	1.35	1.55
e	0.50	BSC
K	0.20	---
L	0.30	0.50
L1	0.00	0.03

GENERIC MARKING DIAGRAM*

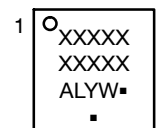

- XXXXX = Specific Device Code
- A = Assembly Location
- L = Wafer Lot
- Y = Year
- W = Work Week
- = Pb-Free Package

(Note: Microdot may be in either location)
*This information is generic. Please refer to device data sheet for actual part marking.
Pb-Free indicator, "G" or microdot "▪", may or may not be present.

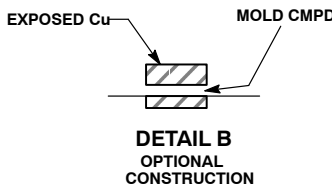
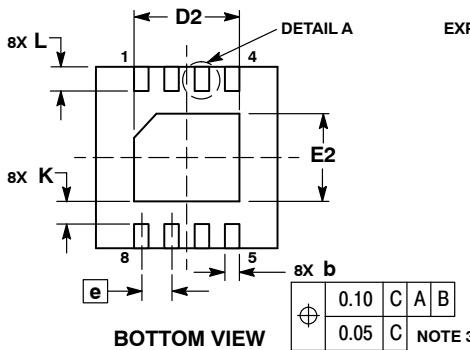

SOLDEMASK DEFINED MOUNTING FOOTPRINT

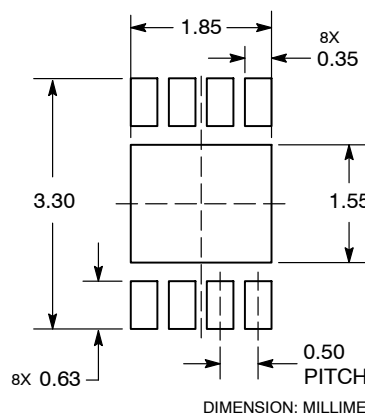

*For additional information on our Pb-Free strategy and soldering details, please download the ON Semiconductor Soldering and Mounting Techniques Reference Manual, SOLDERRM/D.

DOCUMENT NUMBER:	98AON25786D	Electronic versions are uncontrolled except when accessed directly from the Document Repository. Printed versions are uncontrolled except when stamped "CONTROLLED COPY" in red.
DESCRIPTION:	DFN8 3X3, 0.5P	PAGE 1 OF 1

ON Semiconductor and ON are trademarks of Semiconductor Components Industries, LLC dba ON Semiconductor or its subsidiaries in the United States and/or other countries. ON Semiconductor reserves the right to make changes without further notice to any products herein. ON Semiconductor makes no warranty, representation or guarantee regarding the suitability of its products for any particular purpose, nor does ON Semiconductor assume any liability arising out of the application or use of any product or circuit, and specifically disclaims any and all liability, including without limitation special, consequential or incidental damages. ON Semiconductor does not convey any license under its patent rights nor the rights of others.

onsemi, **Onsemi**, and other names, marks, and brands are registered and/or common law trademarks of Semiconductor Components Industries, LLC dba "**onsemi**" or its affiliates and/or subsidiaries in the United States and/or other countries. **onsemi** owns the rights to a number of patents, trademarks, copyrights, trade secrets, and other intellectual property. A listing of **onsemi**'s product/patent coverage may be accessed at www.onsemi.com/site/pdf/Patent-Marking.pdf. **onsemi** reserves the right to make changes at any time to any products or information herein, without notice. The information herein is provided "as-is" and **onsemi** makes no warranty, representation or guarantee regarding the accuracy of the information, product features, availability, functionality, or suitability of its products for any particular purpose, nor does **onsemi** assume any liability arising out of the application or use of any product or circuit, and specifically disclaims any and all liability, including without limitation special, consequential or incidental damages. Buyer is responsible for its products and applications using **onsemi** products, including compliance with all laws, regulations and safety requirements or standards, regardless of any support or applications information provided by **onsemi**. "Typical" parameters which may be provided in **onsemi** data sheets and/or specifications can and do vary in different applications and actual performance may vary over time. All operating parameters, including "Typicals" must be validated for each customer application by customer's technical experts. **onsemi** does not convey any license under any of its intellectual property rights nor the rights of others. **onsemi** products are not designed, intended, or authorized for use as a critical component in life support systems or any FDA Class 3 medical devices or medical devices with a same or similar classification in a foreign jurisdiction or any devices intended for implantation in the human body. Should Buyer purchase or use **onsemi** products for any such unintended or unauthorized application, Buyer shall indemnify and hold **onsemi** and its officers, employees, subsidiaries, affiliates, and distributors harmless against all claims, costs, damages, and expenses, and reasonable attorney fees arising out of, directly or indirectly, any claim of personal injury or death associated with such unintended or unauthorized use, even if such claim alleges that **onsemi** was negligent regarding the design or manufacture of the part. **onsemi** is an Equal Opportunity/Affirmative Action Employer. This literature is subject to all applicable copyright laws and is not for resale in any manner.

PUBLICATION ORDERING INFORMATION

LITERATURE FULFILLMENT:

Email Requests to: orderlit@onsemi.com

onsemi Website: www.onsemi.com

TECHNICAL SUPPORT

North American Technical Support:

Voice Mail: 1 800-282-9855 Toll Free USA/Canada

Phone: 011 421 33 790 2910

Europe, Middle East and Africa Technical Support:

Phone: 00421 33 790 2910

For additional information, please contact your local Sales Representative