

Dual 5 A High Speed Low-Side MOSFET Drivers with Enable



ON Semiconductor®

www.onsemi.com

NCP81071

NCP81071 is a high speed dual low-side MOSFETs driver. It is capable of providing large peak currents into capacitive loads. This driver can deliver 5 A peak current at the Miller plateau region to help reduce the Miller effect during MOSFETs switching transition. This driver also provides enable functions to give users better control capability in different applications. ENA and ENB are implemented on pin 1 and pin 8 which were previously unused in the industry standard pin-out. They are internally pulled up to driver's input voltage for active high logic and can be left open for standard operations. This part is available in MSOP8-EP package, SOIC8 package and WDFN8 3 mm x 3 mm package.

Features

- High Current Drive Capability ± 5 A
- TTL/CMOS Compatible Inputs Independent of Supply Voltage
- Industry Standard Pin-out
- High Reverse Current Capability (6 A) Peak
- Enable Functions for Each Driver
- 8 ns Typical Rise and 8 ns Typical Fall Times with 1.8 nF Load
- Typical Propagation Delay Times of 20 ns with Input Falling and 20 ns with Input Rising
- Input Voltage from 4.5 V to 20 V
- Dual Outputs can be Paralleled for Higher Drive Current
- These Devices are Pb-Free, Halogen Free/BFR Free and are RoHS Compliant

Applications

- Server Power
- Telecommunication, Datacenter Power
- Synchronous Rectifier
- Switch Mode Power Supply
- DC/DC Converter
- Power Factor Correction
- Motor Drive
- Renewable Energy, Solar Inverter

MARKING DIAGRAMS



SOIC-8
D SUFFIX
CASE 751

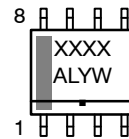

MSOP-8
Z SUFFIX
CASE 846AM

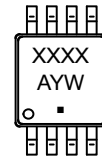

WDFN8
MN SUFFIX
CASE 511CD

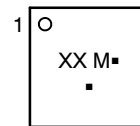

XX = Specific Device Code
A = Assembly Location
L = Wafer Lot
Y = Year
W = Work Week
M = Date Code
▪ = Pb-Free Package

(Note: Microdot may be in either location)

PIN CONNECTIONS

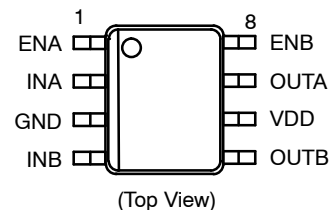

ORDERING INFORMATION

See detailed ordering and shipping information in the package dimensions section on page 11 of this data sheet.

NCP81071

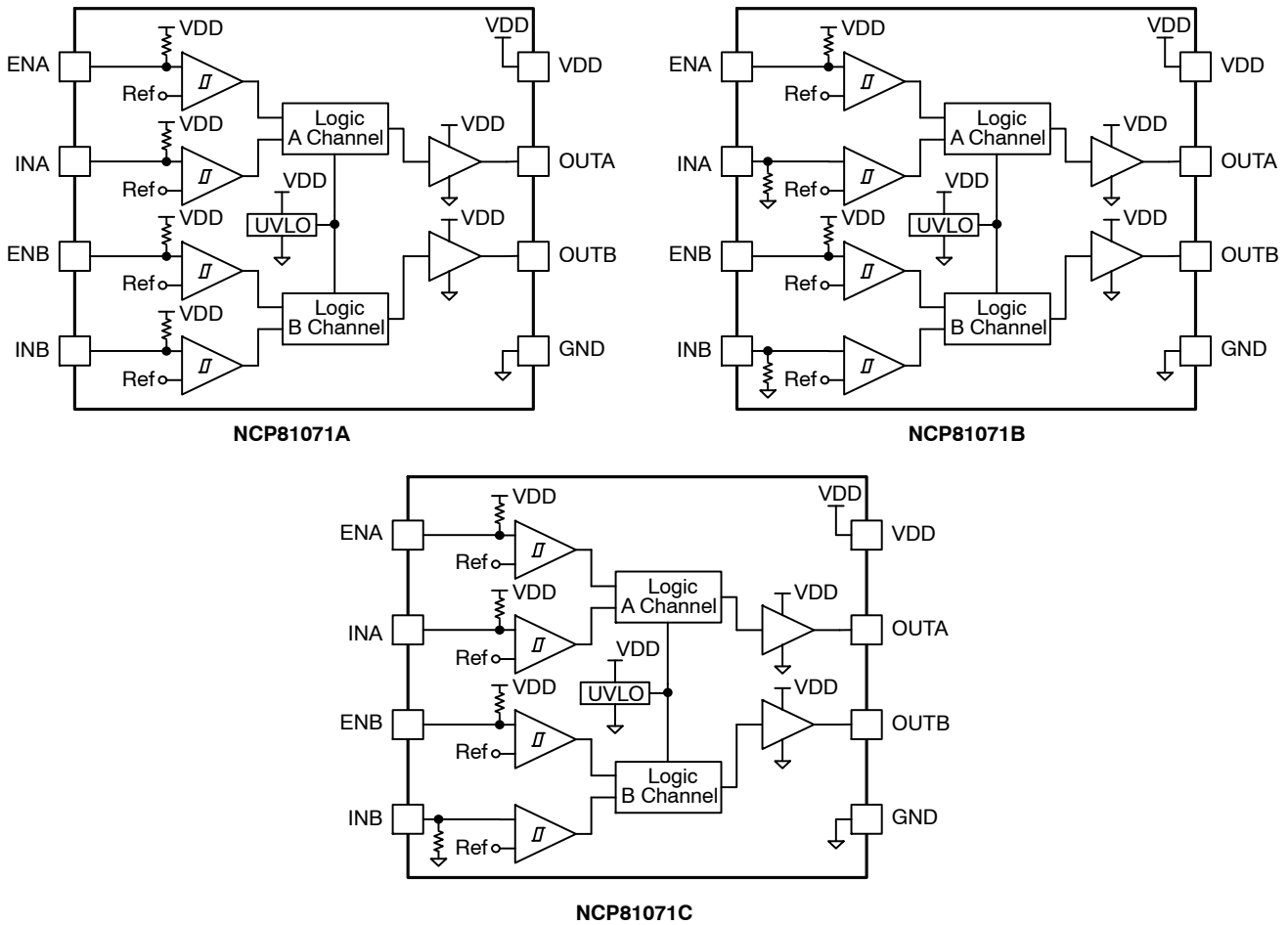

Figure 1. NCP81071 Block Diagram

Table 1. PIN DESCRIPTION

Pin No.	Symbol	Description
1	ENA	Enable input for the driver channel A with logic compatible threshold and hysteresis. This pin is used to enable and disable the driver output. It is internally pulled up to VDD with a 200 kΩ resistor for active high operation. The output of the pin when the device is disabled will be always low.
2	INA	Input of driver channel A which has logic compatible threshold and hysteresis. If not used, this pin should be connected to either VDD or GND. It should not be left unconnected.
3	GND	Common ground. This ground should be connected very closely to the source of the power MOSFET.
4	INB	Input of driver channel B which has logic compatible threshold and hysteresis. If not used, this pin should be connected to either VDD or GND. It should not be left unconnected.
5	OUTB	Output of driver channel B. The driver is able to provide 5 A drive current to the gate of the power MOSFET.
6	VDD	Supply voltage. Use this pin to connect the input power for the driver device.
7	OUTA	Output of driver channel A. The driver is able to provide 5 A drive current to the gate of the power MOSFET.
8	ENB	Enable input for the driver channel B with logic compatible threshold and hysteresis. This pin is used to enable and disable the driver output. It is internally pulled up to VDD with a 200 kΩ resistor for active high operation. The output of the pin when the device is disabled will be always low.

NCP81071

TYPICAL APPLICATION CIRCUIT

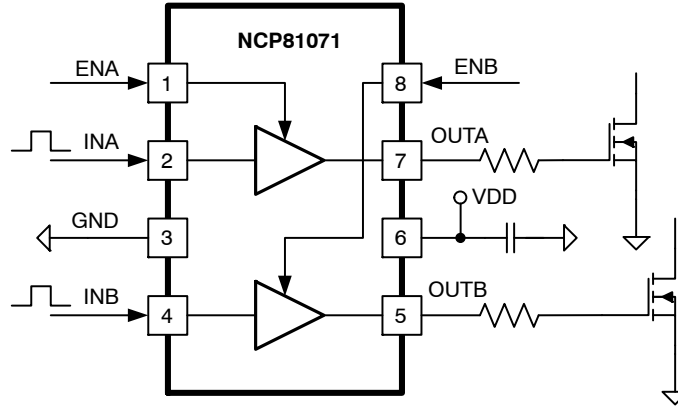

Table 2. ABSOLUTE MAXIMUM RATINGS

		Value		Unit
		Min	Max	
Supply Voltage	VDD	-0.3	24	V
Output Current (DC)	I _{out_dc}	0.3		A
Reverse Current (Pulse < 1 μs)			6.0	A
Output Current (Pulse < 0.5 μs)	I _{out_pulse}	6.0		A
Input Voltage	INA, INB	-6.0	VDD+0.3	V
Enable Voltage	ENA, ENB	-0.3	VDD+0.3	V
Output Voltage	OUTA, OUTB	-0.3	VDD+0.3	V
Output Voltage (Pulse < 0.5 μs)	OUTA, OUTB	-3.0	VDD+3.0	V
Junction Operation Temperature	T _J	-40	150	°C
Storage Temperature	T _{stg}	-65	160	°C
Electrostatic Discharge	Human body model, HBM	4000		V
	Charge device model, CDM	1000		V
OUTA OUTB Latch-up Protection		500		mA

Stresses exceeding those listed in the Maximum Ratings table may damage the device. If any of these limits are exceeded, device functionality should not be assumed, damage may occur and reliability may be affected.

Table 3. RECOMMENDED OPERATING CONDITIONS

Parameter	Rating	Unit
VDD supply Voltage	4.5 to 20	V
INA, INB input voltage	-5.0 to VDD	V
ENA, ENB input voltage	0 to VDD	V
Junction Temperature Range	-40 to +140	°C

Functional operation above the stresses listed in the Recommended Operating Ranges is not implied. Extended exposure to stresses beyond the Recommended Operating Ranges limits may affect device reliability.

Table 4. THERMAL INFORMATION

Package	θ _{JA} (°C/W)	θ _{JC} (°C/W)	Ψ _{JT} (°C/W) (Note 1)
SOIC-8	115	50	
MSOP-8 EP	39	4.7	11
WDFN8 3x3	39	4.7	

1. Ψ_{JT}: approximate thermal impedance, junction-to-case top.

NCP81071

Table 5. INPUT/OUTPUT TABLE

ENA	ENB	INA	INB	NCP81071A		NCP81071B		NCP81071C	
				OUTA	OUTB	OUTA	OUTB	OUTA	OUTB
H	H	L	L	H	H	L	L	H	L
H	H	L	H	H	L	L	H	H	H
H	H	H	L	L	H	H	L	L	L
H	H	H	H	L	L	H	H	L	H
L	L	Any	Any	L	L	L	L	L	L
Any	Any	x (Note 2)	x (Note 2)	L	L	L	L	L	L
x (Note 2)	x (Note 2)	L	L	H	H	L	L	H	L
x (Note 2)	x (Note 2)	L	H	H	L	L	H	H	H
x (Note 2)	x (Note 2)	H	L	L	H	H	L	L	L
x (Note 2)	x (Note 2)	H	H	L	L	H	H	L	H

2. Floating condition, internal resistive pull up or pull down configures output condition

PRODUCT MATRIX

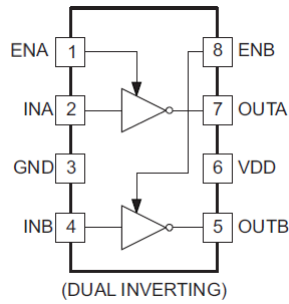

NCP81071A

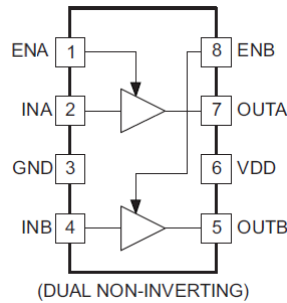

NCP81071B

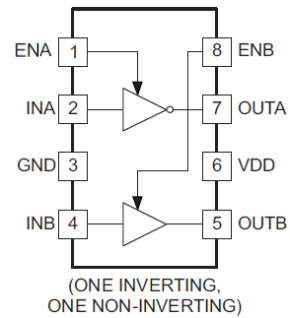

NCP81071C

NCP81071

Table 6. ELECTRICAL CHARACTERISTICS

(Typical values: $V_{DD} = 12\text{ V}$, $1\ \mu\text{F}$ from V_{DD} to GND, $T_A = T_J = -40^\circ\text{C}$ to 140°C , typical at $T_{AMB} = 25^\circ\text{C}$, unless otherwise specified)

Parameter	Symbol	Test Conditions	Min	Typ	Max	Units
SUPPLY VOLTAGE						
VDD Under Voltage Lockout (rising)	V_{CCR}	VDD rising	3.5	4.0	4.5	V
VDD Under Voltage Lockout (hysteresis)	V_{CCH}			400		mV
Operating Current (no switching)	I_{DD}	INA = 0, INB = 5 V, ENA = ENB = 0 INA = 5 V, INB = 0, ENA = ENB = 0 INA = 0, INB = 5 V, ENA = ENB = 5 V INA = 5 V, INB = 0, ENA = ENB = 5 V		1.4	3	mA
VDD Under Voltage Lockout to Output Delay (Note 3)		VDD rising		10		μs

INPUTS

High Threshold	V_{thH}	Input rising from logic low	1.8	2.0	2.2	V
Low Threshold	V_{thL}	Input falling from logic high	0.8	1.0	1.2	V
INA, INB Pull-Up Resistance		OUTA = OUTB = Inverter Configuration		200		$k\Omega$
INA, INB Pull-Down Resistance		OUTA = OUTB = Buffer Configuration		200		$k\Omega$

OUTPUTS

Output Resistance High	R_{OH}	IOU _T = -10 mA		0.8	2	Ω
Output Resistance Low	R_{OL}	IOU _T = +10 mA		0.8	2	Ω
Peak Source Current (Note 4)	I_{Source}	OUTA/OUTB = GND 200 ns Pulse		5		A
Miller Plateau Source Current (Note 4)	I_{Source}	OUTA/OUTB = 5.0 V 200 ns Pulse		4.5		A
Peak Sink Current (Note 4)	I_{Sink}	OUTA/OUTB = VDD 200 ns Pulse		5		A
Miller Plateau Sink Current (Note 4)	I_{Sink}	OUTA/OUTB = 5.0 V 200 ns Pulse		3.5		A

ENABLE

High-Level Input Voltage	V_{IN_H}	Low to High Transition	1.8	2.0	2.2	V
Low-Level Input Voltage	V_{IN_L}	High to Low Transition	0.8	1.0	1.2	V
ENA, ENB pull-up resistance				200		$k\Omega$
Propagation Delay Time (EN to OUT) (Notes 3, 5)	t_{d3}	$C_{Load} = 1.8\text{ nF}$	16	20	29	ns
Propagation Delay Time (EN to OUT) (Notes 3, 5)	t_{d4}	$C_{Load} = 1.8\text{ nF}$	16	20	29	ns

SWITCHING CHARACTERISTICS

Propagation Delay Time Low to High, IN Rising (IN to OUT) (Notes 3, 5)	t_{d1}	$C_{Load} = 1.8\text{ nF}$	16	20	29	ns
Propagation Delay Time High to Low, IN Falling (IN to OUT) (Notes 3, 5)	t_{d2}	$C_{Load} = 1.8\text{ nF}$	16	20	29	ns
Rise Time (Note 5)	t_r	$C_{Load} = 1.8\text{ nF}$		8	15	ns
Fall Time (Note 5)	t_f	$C_{Load} = 1.8\text{ nF}$		8	15	ns
Delay Matching between 2 Channels (Note 6)	t_m	INA = INB, OUTA and OUTB at 50% Transition Point		1	4	ns

Product parametric performance is indicated in the Electrical Characteristics for the listed test conditions, unless otherwise noted. Product performance may not be indicated by the Electrical Characteristics if operated under different conditions.

3. Guaranteed by design.

4. Not production tested, guaranteed by design and statistical analysis.

5. See timing diagrams in Figure 2, Figure 3, Figure 4 and Figure 5.

6. Guaranteed by characterization.

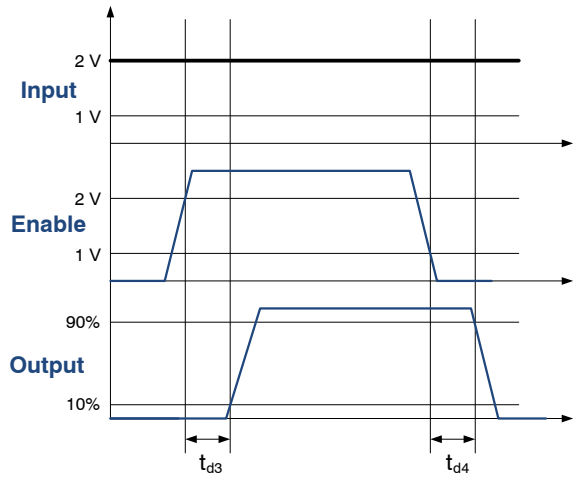

Figure 2. Enable Function for Non-inverting Input Driver Operation

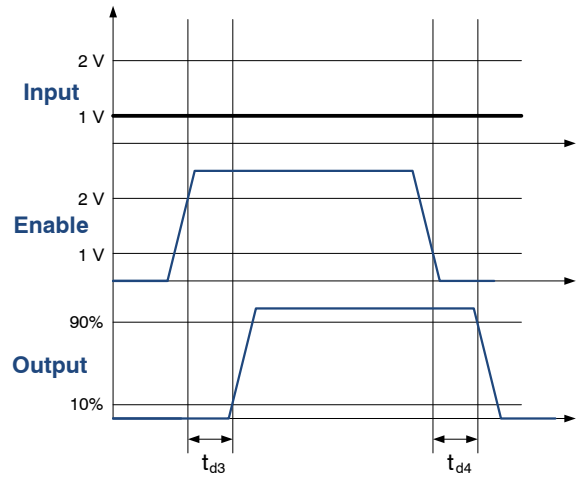

Figure 3. Enable Function for Inverting Input Driver Operation

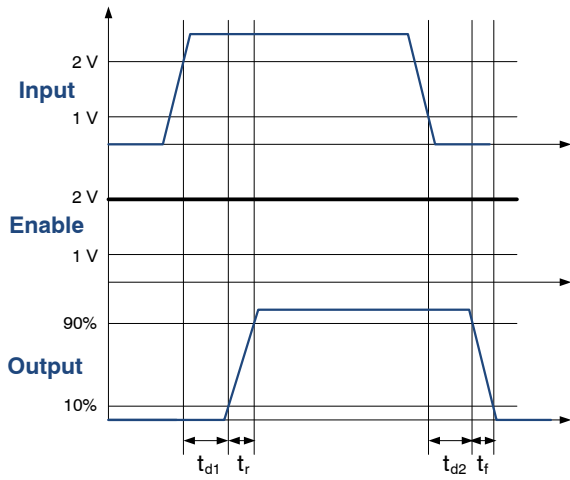

Figure 4. Non-inverting Input Driver Operation

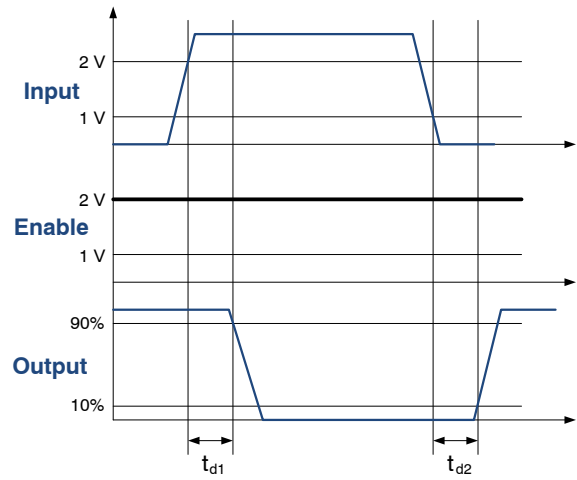

Figure 5. Inverting Input Driver Operation

TYPICAL CHARACTERISTICS

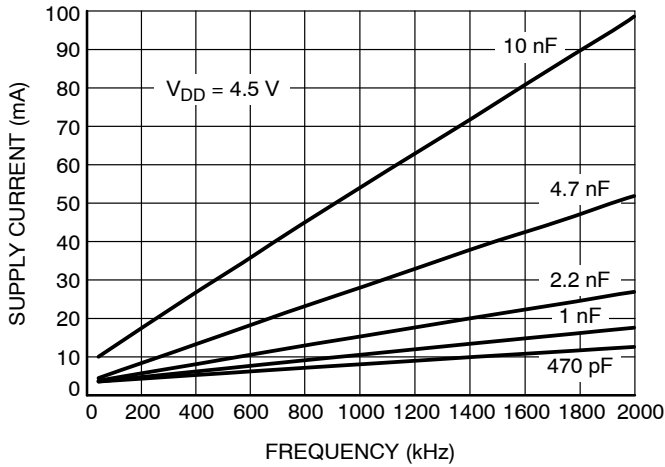

Figure 6. Supply Current vs. Switching Frequency ($V_{DD} = 4.5\text{ V}$)



Figure 7. Supply Current vs. Switching Frequency ($V_{DD} = 8.0\text{ V}$)

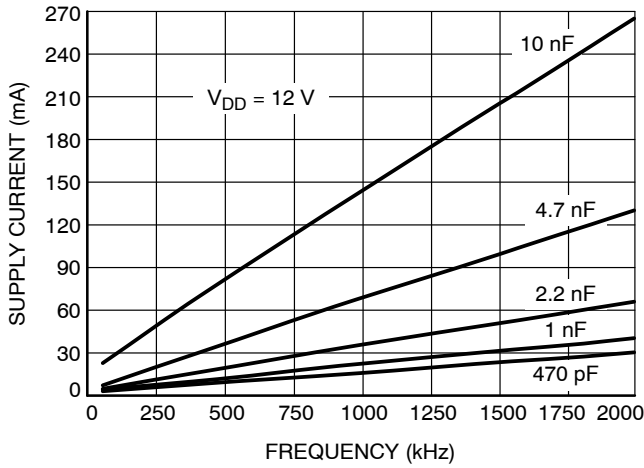

Figure 8. Supply Current vs. Switching Frequency ($V_{DD} = 12\text{ V}$)



Figure 9. Supply Current vs. Switching Frequency ($V_{DD} = 15\text{ V}$)

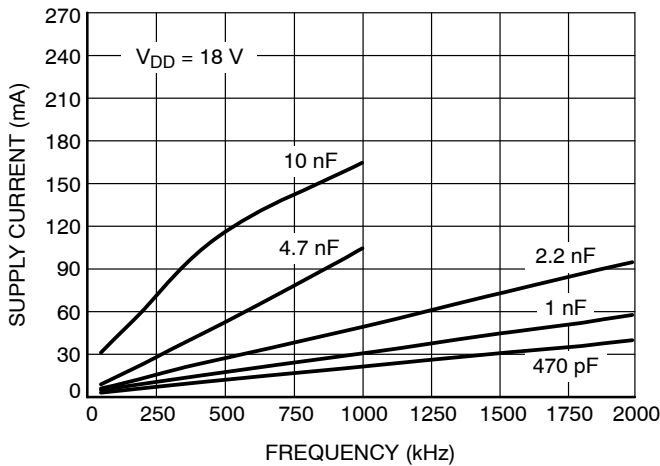

Figure 10. Supply Current vs. Switching Frequency ($V_{DD} = 18\text{ V}$)

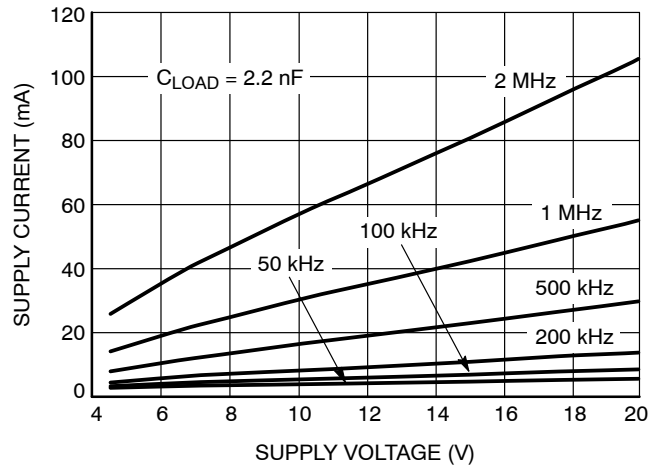

Figure 11. Supply Current vs. Supply Voltage ($C_{LOAD} = 2.2\text{ nF}$)

NCP81071

TYPICAL CHARACTERISTICS

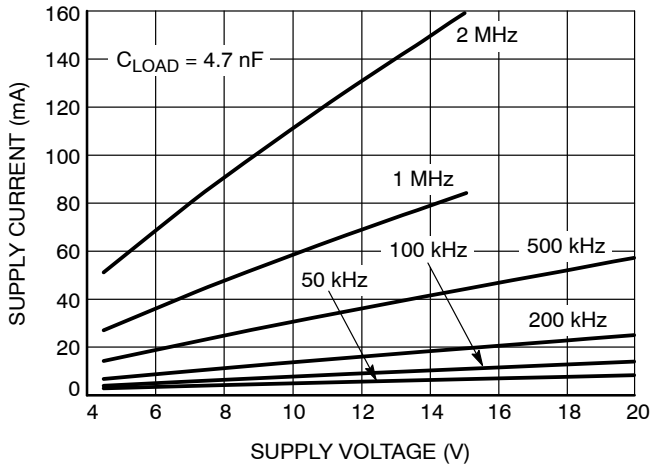

Figure 12. Supply Current vs. Supply Voltage ($C_{LOAD} = 4.7 \text{ nF}$)



Figure 13. Supply Current vs. Supply Voltage (NCP81071A)

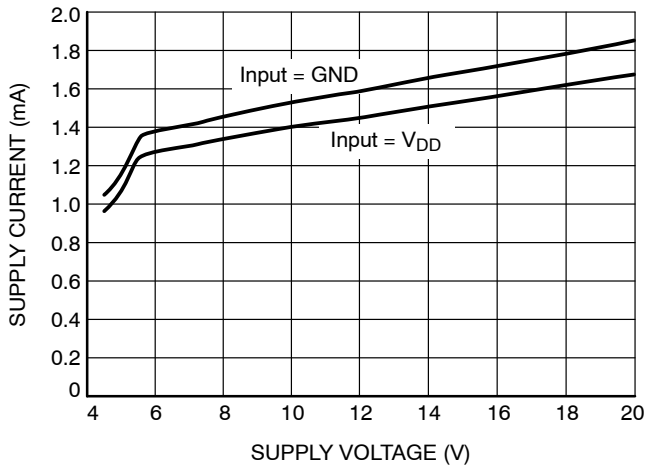

Figure 14. Supply Current vs. Supply Voltage (NCP81071B)

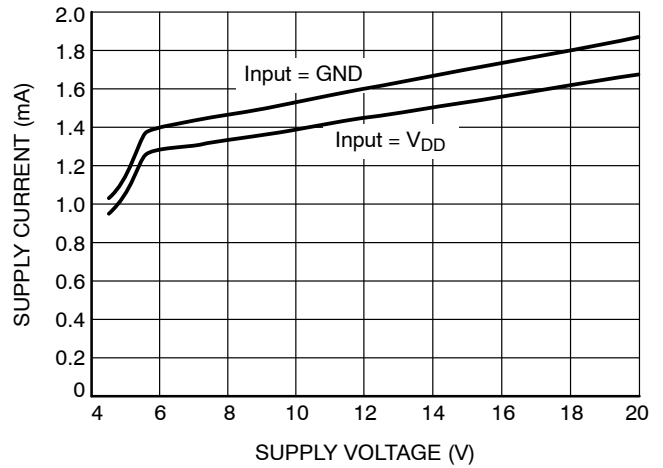

Figure 15. Supply Current vs. Supply Voltage (NCP81071C)

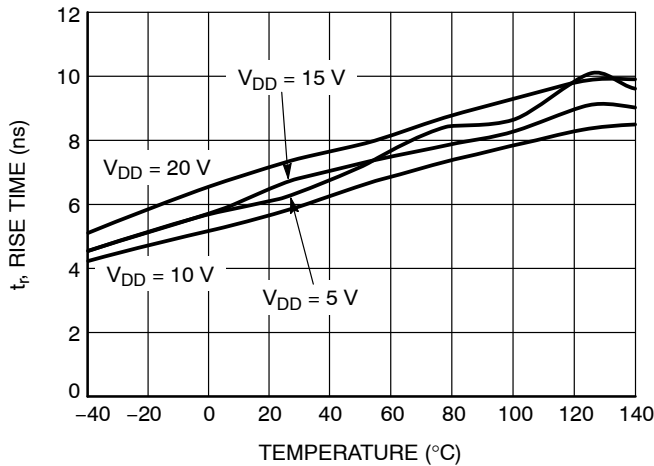

Figure 16. Rise Time vs. Temperature

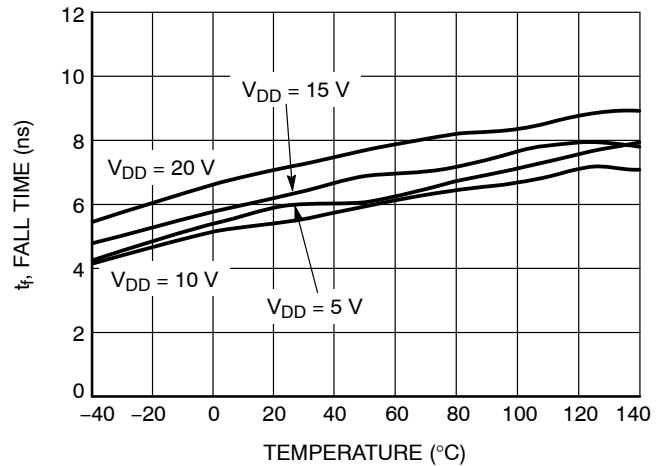

Figure 17. Fall Time vs. Temperature

NCP81071

TYPICAL CHARACTERISTICS

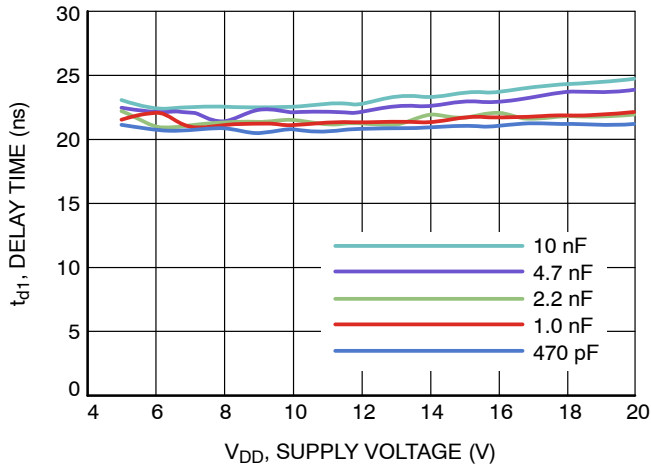

Figure 18. Propagation Delay t_{d1} vs. Supply Voltage

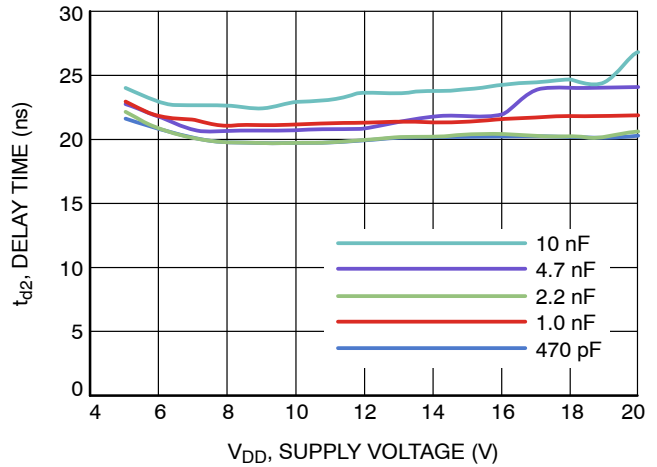

Figure 19. Propagation Delay t_{d2} vs. Supply Voltage

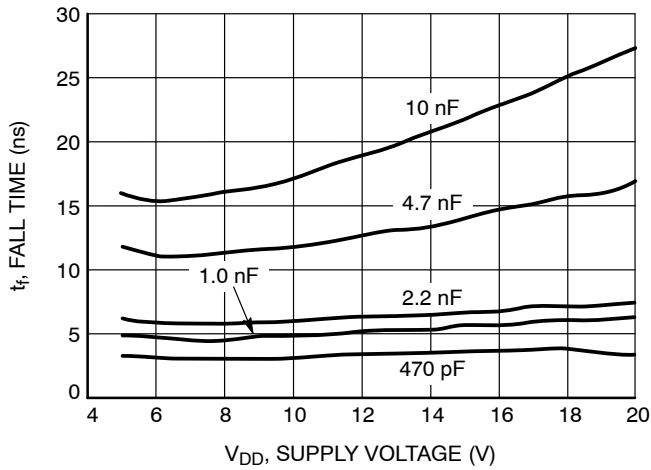

Figure 20. Fall Time t_f vs. Supply Voltage

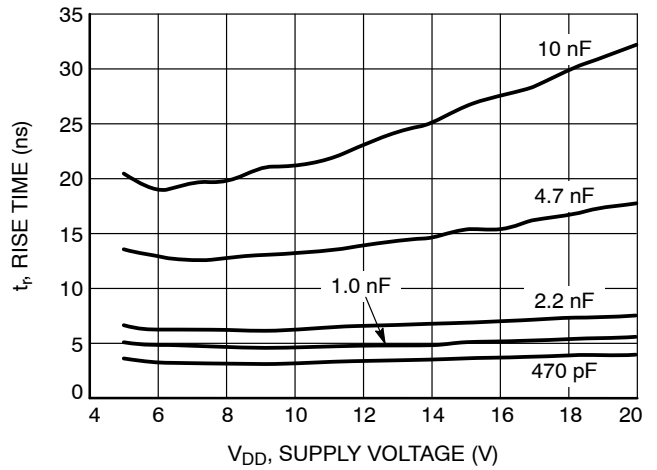

Figure 21. Rise Time t_r vs. Supply Voltage



Figure 22. Output Behavior vs. Supply Voltage NCP81071A (Inverting) 10 nF between Output and GND, INA = GND, ENA = VDD



Figure 23. Output Behavior vs. Supply Voltage NCP81071A (Inverting) 10 nF between Output and GND, INA = GND, ENA = VDD

NCP81071

TYPICAL CHARACTERISTICS

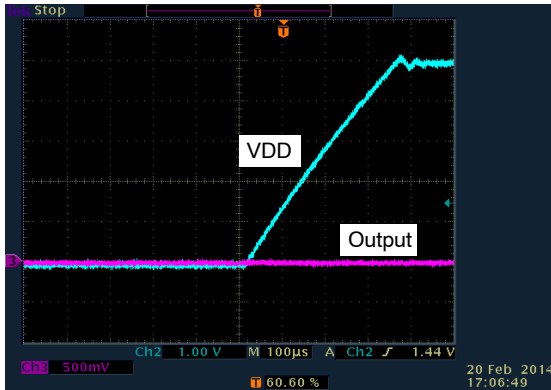

Figure 24. Output Behavior vs. Supply Voltage NCP81071A (Inverting) 10 nF between Output and GND, INA = VDD, ENA = VDD

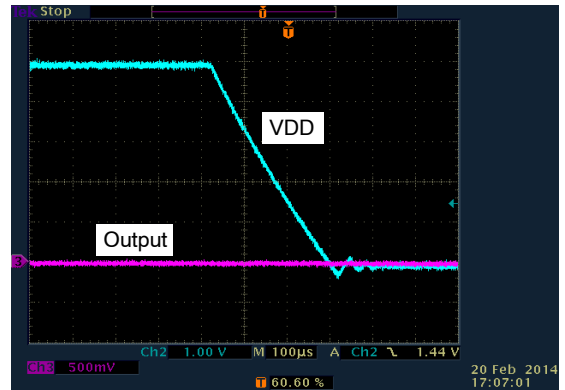

Figure 25. Output Behavior vs. Supply Voltage NCP81071A (Inverting) 10 nF between Output and GND, INA = VDD, ENA = VDD

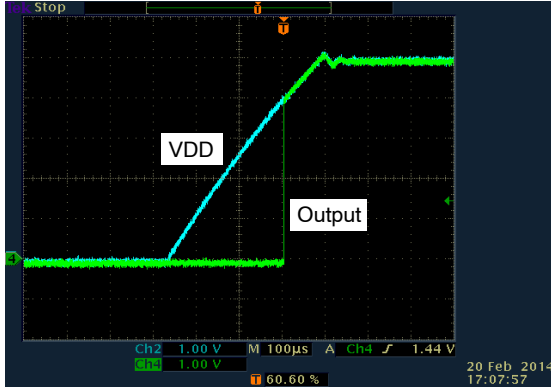

Figure 26. Output Behavior vs. Supply Voltage NCP81071B (Non-inverting) 10 nF between Output and GND, INA = VDD, ENA = VDD

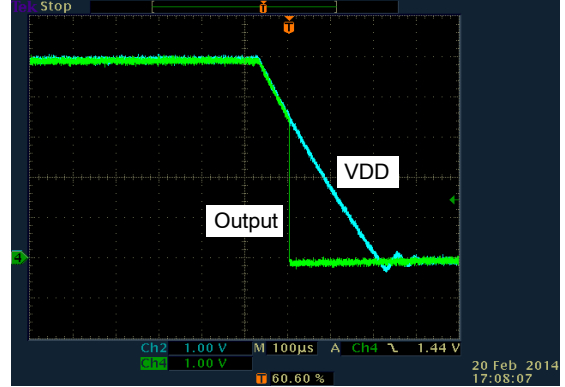

Figure 27. Output Behavior vs. Supply Voltage NCP81071B (Non-inverting) 10 nF between Output and GND, INA = VDD, ENA = VDD

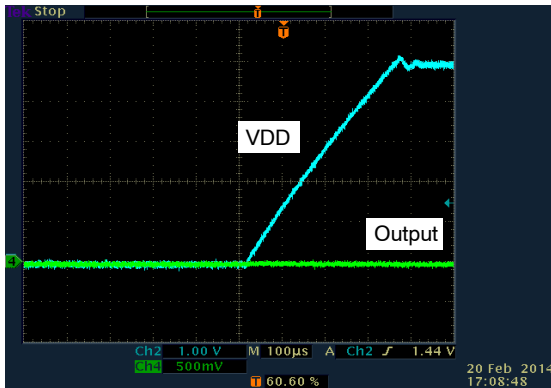

Figure 28. Output Behavior vs. Supply Voltage NCP81071B (Non-inverting) 10 nF between Output and GND, INA = GND, ENA = VDD

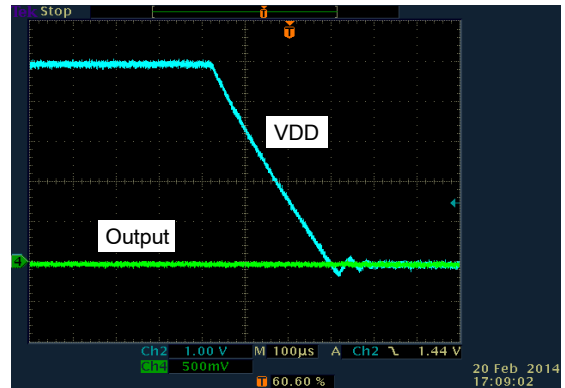

Figure 29. Output Behavior vs. Supply Voltage NCP81071B (Non-inverting) 10 nF between Output and GND, INA = GND, ENA = VDD

NCP81071

LAYOUT GUIDELINES

The switching performance of NCP81071 highly depends on the design of PCB board. The following layout design guidelines are recommended when designing boards using these high speed drivers.

Place the driver as close as possible to the driven MOSFET.

Place the bypass capacitor between VDD and GND as close as possible to the driver to improve the noise filtering. It is preferred to use low inductance components such as chip capacitor and chip resistor. If vias are used, connect several paralleled vias to reduce the inductance of the vias.

Minimize the turn-on/sourcing current and turn-off/sinking current paths in order to minimize stray inductance. Otherwise high di/dt established in these loops with stray inductance can induce significant voltage spikes on the output of the driver and MOSFET Gate terminal.

Keep power loops as short as possible by paralleling the source and return traces (flux cancellation).

Keep low level signal lines away from high level power lines with a lot of switching noise.

Place a ground plane for better noise shielding. Beside noise shielding, ground plane is also useful for heat dissipation.

NCP81071 DFN and MSOP package have thermal pad for: 1) quiet GND for all the driver circuits; 2) heat sink for the driver. This pad must be connected to a ground plane and no switching currents from the driven MOSFET should pass through the ground plane under the driver. To maximize the heatsinking capability, it is recommended several ground layers are added to connect to the ground plane and thermal pad. A via array within the area of package can conduct the heat from the package to the ground layers and the whole PCB board. The number of vias and the size of ground plane are determined by the power dissipation of NCP81071 (VDD voltage, switching frequency and load condition), the air flow condition and its maximum junction temperature.

ORDERING INFORMATION

Part Number	Output Configuration	Temperature Range (°C)	Package Type	Shipping [†]
NCP81071ADR2G	dual inverting	-40 to +140	SOIC-8 (Pb-Free)	2500 / Tape & Reel
NCP81071BDR2G	dual non inverting			
NCP81071CDR2G	One inverting one non inverting			
NCP81071AZR2G	dual inverting		MSOP8 EP (Pb-Free)	3000 / Tape & Reel
NCP81071BZR2G	dual non inverting			
NCP81071CZR2G	One inverting one non inverting			
NCP81071AMNTXG	dual inverting		WDFN8 (Pb-Free)	3000 / Tape & Reel
NCP81071BMNTXG	dual non inverting			
NCP81071CMNTXG	One inverting one non inverting			

[†]For information on tape and reel specifications, including part orientation and tape sizes, please refer to our Tape and Reel Packaging Specifications Brochure, BRD8011/D.

MECHANICAL CASE OUTLINE

PACKAGE DIMENSIONS

ON Semiconductor®



SCALE 2:1

WDFN8 3x3, 0.65P
CASE 511CD
ISSUE O

DATE 29 APR 2014

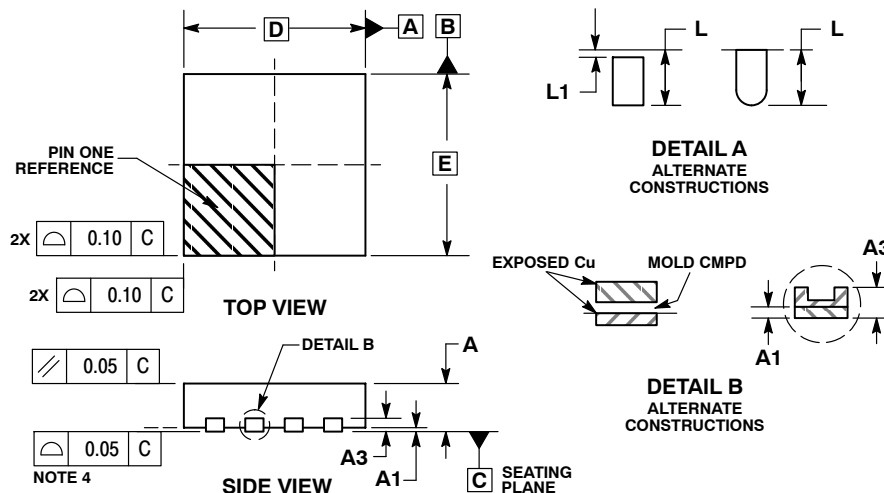

- NOTES:
1. DIMENSIONING AND TOLERANCING PER ASME Y14.5M, 1994.
 2. CONTROLLING DIMENSION: MILLIMETERS.
 3. DIMENSION b APPLIES TO PLATED TERMINAL AND IS MEASURED BETWEEN 0.15 AND 0.30 MM FROM TERMINAL TIP.
 4. COPLANARITY APPLIES TO THE EXPOSED PAD AS WELL AS THE TERMINALS.

DIM	MILLIMETERS	
	MIN	MAX
A	0.70	0.80
A1	0.00	0.05
A3	0.20 REF	
b	0.25	0.35
D	3.00 BSC	
D2	2.05	2.25
E	3.00 BSC	
E2	1.10	1.30
e	0.65 BSC	
K	0.20	---
L	0.30	0.50
L1	0.00	0.15

GENERIC MARKING DIAGRAM*

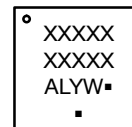

- A = Assembly Location
- L = Wafer Lot
- Y = Year
- W = Work Week
- = Pb-Free Package

(Note: Microdot may be in either location)

*This information is generic. Please refer to device data sheet for actual part marking. Pb-Free indicator, "G" or microdot "▪", may or may not be present.

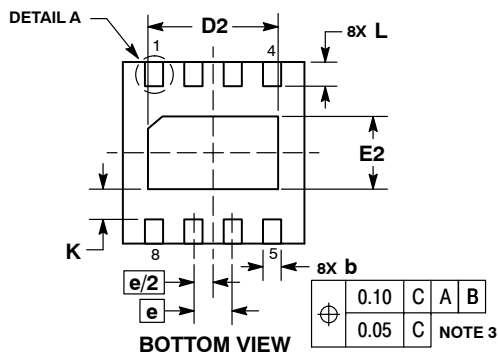

RECOMMENDED SOLDERING FOOTPRINT*

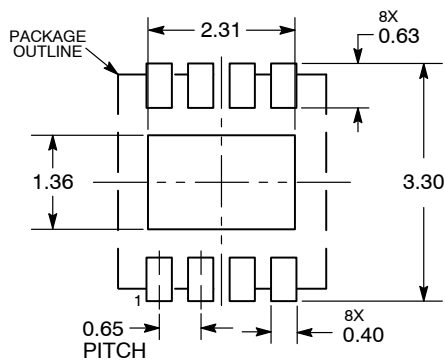

*For additional information on our Pb-Free strategy and soldering details, please download the ON Semiconductor Soldering and Mounting Techniques Reference Manual, SOLDERRM/D.

DOCUMENT NUMBER:	98AON84944F	Electronic versions are uncontrolled except when accessed directly from the Document Repository. Printed versions are uncontrolled except when stamped "CONTROLLED COPY" in red.
DESCRIPTION:	WDFN8, 3X3, 0.65P	PAGE 1 OF 1

ON Semiconductor and ON are trademarks of Semiconductor Components Industries, LLC dba ON Semiconductor or its subsidiaries in the United States and/or other countries. ON Semiconductor reserves the right to make changes without further notice to any products herein. ON Semiconductor makes no warranty, representation or guarantee regarding the suitability of its products for any particular purpose, nor does ON Semiconductor assume any liability arising out of the application or use of any product or circuit, and specifically disclaims any and all liability, including without limitation special, consequential or incidental damages. ON Semiconductor does not convey any license under its patent rights nor the rights of others.

MECHANICAL CASE OUTLINE PACKAGE DIMENSIONS

ON Semiconductor®



SCALE 1:1

SOIC-8 NB
CASE 751-07
ISSUE AK

DATE 16 FEB 2011



- NOTES:
1. DIMENSIONING AND TOLERANCING PER ANSI Y14.5M, 1982.
 2. CONTROLLING DIMENSION: MILLIMETER.
 3. DIMENSION A AND B DO NOT INCLUDE MOLD PROTRUSION.
 4. MAXIMUM MOLD PROTRUSION 0.15 (0.006) PER SIDE.
 5. DIMENSION D DOES NOT INCLUDE DAMBAR PROTRUSION. ALLOWABLE DAMBAR PROTRUSION SHALL BE 0.127 (0.005) TOTAL IN EXCESS OF THE D DIMENSION AT MAXIMUM MATERIAL CONDITION.
 6. 751-01 THRU 751-06 ARE OBSOLETE. NEW STANDARD IS 751-07.

DIM	MILLIMETERS		INCHES	
	MIN	MAX	MIN	MAX
A	4.80	5.00	0.189	0.197
B	3.80	4.00	0.150	0.157
C	1.35	1.75	0.053	0.069
D	0.33	0.51	0.013	0.020
G	1.27 BSC		0.050 BSC	
H	0.10	0.25	0.004	0.010
J	0.19	0.25	0.007	0.010
K	0.40	1.27	0.016	0.050
M	0°	8°	0°	8°
N	0.25	0.50	0.010	0.020
S	5.80	6.20	0.228	0.244

SOLDERING FOOTPRINT*



*For additional information on our Pb-Free strategy and soldering details, please download the ON Semiconductor Soldering and Mounting Techniques Reference Manual, SOLDERRM/D.

GENERIC MARKING DIAGRAM*



XXXXXX = Specific Device Code
 A = Assembly Location
 L = Wafer Lot
 Y = Year
 W = Work Week
 ■ = Pb-Free Package

XXXXXX = Specific Device Code
 A = Assembly Location
 Y = Year
 WW = Work Week
 ■ = Pb-Free Package

*This information is generic. Please refer to device data sheet for actual part marking. Pb-Free indicator, "G" or microdot "•", may or may not be present. Some products may not follow the Generic Marking.

STYLES ON PAGE 2

DOCUMENT NUMBER:	98ASB42564B	Electronic versions are uncontrolled except when accessed directly from the Document Repository. Printed versions are uncontrolled except when stamped "CONTROLLED COPY" in red.
DESCRIPTION:	SOIC-8 NB	PAGE 1 OF 2

ON Semiconductor and ON are trademarks of Semiconductor Components Industries, LLC dba ON Semiconductor or its subsidiaries in the United States and/or other countries. ON Semiconductor reserves the right to make changes without further notice to any products herein. ON Semiconductor makes no warranty, representation or guarantee regarding the suitability of its products for any particular purpose, nor does ON Semiconductor assume any liability arising out of the application or use of any product or circuit, and specifically disclaims any and all liability, including without limitation special, consequential or incidental damages. ON Semiconductor does not convey any license under its patent rights nor the rights of others.

SOIC-8 NB
CASE 751-07
ISSUE AK

DATE 16 FEB 2011

- | | | | |
|--|---|---|---|
| <p>STYLE 1:
 PIN 1. EMITTER
 2. COLLECTOR
 3. COLLECTOR
 4. EMITTER
 5. EMITTER
 6. BASE
 7. BASE
 8. EMITTER</p> | <p>STYLE 2:
 PIN 1. COLLECTOR, DIE, #1
 2. COLLECTOR, #1
 3. COLLECTOR, #2
 4. COLLECTOR, #2
 5. BASE, #2
 6. EMITTER, #2
 7. BASE, #1
 8. EMITTER, #1</p> | <p>STYLE 3:
 PIN 1. DRAIN, DIE #1
 2. DRAIN, #1
 3. DRAIN, #2
 4. DRAIN, #2
 5. GATE, #2
 6. SOURCE, #2
 7. GATE, #1
 8. SOURCE, #1</p> | <p>STYLE 4:
 PIN 1. ANODE
 2. ANODE
 3. ANODE
 4. ANODE
 5. ANODE
 6. ANODE
 7. ANODE
 8. COMMON CATHODE</p> |
| <p>STYLE 5:
 PIN 1. DRAIN
 2. DRAIN
 3. DRAIN
 4. DRAIN
 5. GATE
 6. GATE
 7. SOURCE
 8. SOURCE</p> | <p>STYLE 6:
 PIN 1. SOURCE
 2. DRAIN
 3. DRAIN
 4. SOURCE
 5. SOURCE
 6. GATE
 7. GATE
 8. SOURCE</p> | <p>STYLE 7:
 PIN 1. INPUT
 2. EXTERNAL BYPASS
 3. THIRD STAGE SOURCE
 4. GROUND
 5. DRAIN
 6. GATE 3
 7. SECOND STAGE Vd
 8. FIRST STAGE Vd</p> | <p>STYLE 8:
 PIN 1. COLLECTOR, DIE #1
 2. BASE, #1
 3. BASE, #2
 4. COLLECTOR, #2
 5. COLLECTOR, #2
 6. EMITTER, #2
 7. EMITTER, #1
 8. COLLECTOR, #1</p> |
| <p>STYLE 9:
 PIN 1. EMITTER, COMMON
 2. COLLECTOR, DIE #1
 3. COLLECTOR, DIE #2
 4. EMITTER, COMMON
 5. EMITTER, COMMON
 6. BASE, DIE #2
 7. BASE, DIE #1
 8. EMITTER, COMMON</p> | <p>STYLE 10:
 PIN 1. GROUND
 2. BIAS 1
 3. OUTPUT
 4. GROUND
 5. GROUND
 6. BIAS 2
 7. INPUT
 8. GROUND</p> | <p>STYLE 11:
 PIN 1. SOURCE 1
 2. GATE 1
 3. SOURCE 2
 4. GATE 2
 5. DRAIN 2
 6. DRAIN 2
 7. DRAIN 1
 8. DRAIN 1</p> | <p>STYLE 12:
 PIN 1. SOURCE
 2. SOURCE
 3. SOURCE
 4. GATE
 5. DRAIN
 6. DRAIN
 7. DRAIN
 8. DRAIN</p> |
| <p>STYLE 13:
 PIN 1. N.C.
 2. SOURCE
 3. SOURCE
 4. GATE
 5. DRAIN
 6. DRAIN
 7. DRAIN
 8. DRAIN</p> | <p>STYLE 14:
 PIN 1. N-SOURCE
 2. N-GATE
 3. P-SOURCE
 4. P-GATE
 5. P-DRAIN
 6. P-DRAIN
 7. N-DRAIN
 8. N-DRAIN</p> | <p>STYLE 15:
 PIN 1. ANODE 1
 2. ANODE 1
 3. ANODE 1
 4. ANODE 1
 5. CATHODE, COMMON
 6. CATHODE, COMMON
 7. CATHODE, COMMON
 8. CATHODE, COMMON</p> | <p>STYLE 16:
 PIN 1. EMITTER, DIE #1
 2. BASE, DIE #1
 3. EMITTER, DIE #2
 4. BASE, DIE #2
 5. COLLECTOR, DIE #2
 6. COLLECTOR, DIE #2
 7. COLLECTOR, DIE #1
 8. COLLECTOR, DIE #1</p> |
| <p>STYLE 17:
 PIN 1. VCC
 2. V2OUT
 3. V1OUT
 4. TXE
 5. RXE
 6. VEE
 7. GND
 8. ACC</p> | <p>STYLE 18:
 PIN 1. ANODE
 2. ANODE
 3. SOURCE
 4. GATE
 5. DRAIN
 6. DRAIN
 7. CATHODE
 8. CATHODE</p> | <p>STYLE 19:
 PIN 1. SOURCE 1
 2. GATE 1
 3. SOURCE 2
 4. GATE 2
 5. DRAIN 2
 6. MIRROR 2
 7. DRAIN 1
 8. MIRROR 1</p> | <p>STYLE 20:
 PIN 1. SOURCE (N)
 2. GATE (N)
 3. SOURCE (P)
 4. GATE (P)
 5. DRAIN
 6. DRAIN
 7. DRAIN
 8. DRAIN</p> |
| <p>STYLE 21:
 PIN 1. CATHODE 1
 2. CATHODE 2
 3. CATHODE 3
 4. CATHODE 4
 5. CATHODE 5
 6. COMMON ANODE
 7. COMMON ANODE
 8. CATHODE 6</p> | <p>STYLE 22:
 PIN 1. I/O LINE 1
 2. COMMON CATHODE/VCC
 3. COMMON CATHODE/VCC
 4. I/O LINE 3
 5. COMMON ANODE/GND
 6. I/O LINE 4
 7. I/O LINE 5
 8. COMMON ANODE/GND</p> | <p>STYLE 23:
 PIN 1. LINE 1 IN
 2. COMMON ANODE/GND
 3. COMMON ANODE/GND
 4. LINE 2 IN
 5. LINE 2 OUT
 6. COMMON ANODE/GND
 7. COMMON ANODE/GND
 8. LINE 1 OUT</p> | <p>STYLE 24:
 PIN 1. BASE
 2. EMITTER
 3. COLLECTOR/ANODE
 4. COLLECTOR/ANODE
 5. CATHODE
 6. CATHODE
 7. COLLECTOR/ANODE
 8. COLLECTOR/ANODE</p> |
| <p>STYLE 25:
 PIN 1. VIN
 2. N/C
 3. REXT
 4. GND
 5. IOUT
 6. IOUT
 7. IOUT
 8. IOUT</p> | <p>STYLE 26:
 PIN 1. GND
 2. dv/dt
 3. ENABLE
 4. ILIMIT
 5. SOURCE
 6. SOURCE
 7. SOURCE
 8. VCC</p> | <p>STYLE 27:
 PIN 1. ILIMIT
 2. OVLO
 3. UVLO
 4. INPUT+
 5. SOURCE
 6. SOURCE
 7. SOURCE
 8. DRAIN</p> | <p>STYLE 28:
 PIN 1. SW_TO_GND
 2. DASIC OFF
 3. DASIC_SW_DET
 4. GND
 5. V_MON
 6. VBULK
 7. VBULK
 8. VIN</p> |
| <p>STYLE 29:
 PIN 1. BASE, DIE #1
 2. EMITTER, #1
 3. BASE, #2
 4. EMITTER, #2
 5. COLLECTOR, #2
 6. COLLECTOR, #2
 7. COLLECTOR, #1
 8. COLLECTOR, #1</p> | <p>STYLE 30:
 PIN 1. DRAIN 1
 2. DRAIN 1
 3. GATE 2
 4. SOURCE 2
 5. SOURCE 1/DRAIN 2
 6. SOURCE 1/DRAIN 2
 7. SOURCE 1/DRAIN 2
 8. GATE 1</p> | | |

DOCUMENT NUMBER:	98ASB42564B	Electronic versions are uncontrolled except when accessed directly from the Document Repository. Printed versions are uncontrolled except when stamped "CONTROLLED COPY" in red.
DESCRIPTION:	SOIC-8 NB	PAGE 2 OF 2

ON Semiconductor and  are trademarks of Semiconductor Components Industries, LLC dba ON Semiconductor or its subsidiaries in the United States and/or other countries. ON Semiconductor reserves the right to make changes without further notice to any products herein. ON Semiconductor makes no warranty, representation or guarantee regarding the suitability of its products for any particular purpose, nor does ON Semiconductor assume any liability arising out of the application or use of any product or circuit, and specifically disclaims any and all liability, including without limitation special, consequential or incidental damages. ON Semiconductor does not convey any license under its patent rights nor the rights of others.

MECHANICAL CASE OUTLINE

PACKAGE DIMENSIONS

ON Semiconductor®



SCALE 1:1

MSOP8 EP, 3x3
CASE 846AM
ISSUE O

DATE 27 FEB 2014

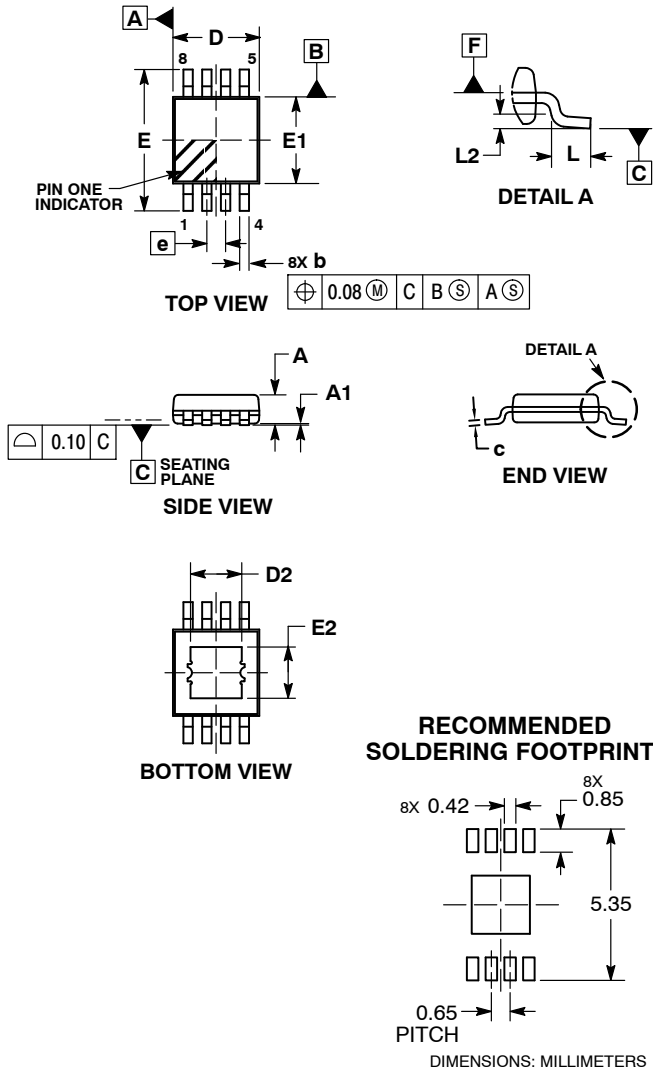

NOTES:

1. DIMENSIONS AND TOLERANCING PER ASME Y14.5M, 1994.
2. CONTROLLING DIMENSIONS: MILLIMETERS.
3. DIMENSION b DOES NOT INCLUDE DAMBAR PROTRUSION. ALLOWABLE DAMBAR PROTRUSION SHALL BE 0.10 MM IN EXCESS OF MAXIMUM MATERIAL CONDITION.
4. DIMENSION D DOES NOT INCLUDE MOLD FLASH, PROTRUSIONS, OR GATE BURRS. MOLD FLASH, PROTRUSIONS, OR GATE BURRS SHALL NOT EXCEED 0.15 MM PER SIDE. DIMENSION E DOES NOT INCLUDE INTERLEAD FLASH OR PROTRUSION. INTERLEAD FLASH OR PROTRUSION SHALL NOT EXCEED 0.25 MM PER SIDE. DIMENSIONS D AND E ARE DETERMINED AT DATUM F.
5. DATUMS A AND B TO BE DETERMINED AT DATUM F.
6. A1 IS DEFINED AS THE VERTICAL DISTANCE FROM THE SEATING PLANE TO THE LOWEST POINT ON THE PACKAGE BODY.

DIM	MILLIMETERS	
	MIN	MAX
A	---	1.10
A1	0.05	0.15
b	0.25	0.40
c	0.13	0.23
D	2.90	3.10
D2	1.78	REF
E	4.75	5.05
E1	2.90	3.10
E2	1.42	REF
e	0.65	BSC
L	0.40	0.70
L2	0.254	BSC

GENERIC MARKING DIAGRAM*

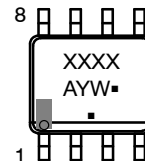

- XXXX = Specific Device Code
- A = Assembly Location
- Y = Year
- W = Work Week
- = Pb-Free Package

(Note: Microdot may be in either location)
*This information is generic. Please refer to device data sheet for actual part marking.
Pb-Free indicator, "G" or microdot "▪", may or may not be present and may be in either location.

*For additional information on our Pb-Free strategy and soldering details, please download the ON Semiconductor Soldering and Mounting Techniques Reference Manual, SOLDERRM/D.

DOCUMENT NUMBER:	98AON82708F	Electronic versions are uncontrolled except when accessed directly from the Document Repository. Printed versions are uncontrolled except when stamped "CONTROLLED COPY" in red.
DESCRIPTION:	MSOP8 EP, 3X3	PAGE 1 OF 1

ON Semiconductor and ON are trademarks of Semiconductor Components Industries, LLC dba ON Semiconductor or its subsidiaries in the United States and/or other countries. ON Semiconductor reserves the right to make changes without further notice to any products herein. ON Semiconductor makes no warranty, representation or guarantee regarding the suitability of its products for any particular purpose, nor does ON Semiconductor assume any liability arising out of the application or use of any product or circuit, and specifically disclaims any and all liability, including without limitation special, consequential or incidental damages. ON Semiconductor does not convey any license under its patent rights nor the rights of others.

onsemi, **Onsemi**, and other names, marks, and brands are registered and/or common law trademarks of Semiconductor Components Industries, LLC dba "**onsemi**" or its affiliates and/or subsidiaries in the United States and/or other countries. **onsemi** owns the rights to a number of patents, trademarks, copyrights, trade secrets, and other intellectual property. A listing of **onsemi**'s product/patent coverage may be accessed at www.onsemi.com/site/pdf/Patent-Marking.pdf. **onsemi** reserves the right to make changes at any time to any products or information herein, without notice. The information herein is provided "as-is" and **onsemi** makes no warranty, representation or guarantee regarding the accuracy of the information, product features, availability, functionality, or suitability of its products for any particular purpose, nor does **onsemi** assume any liability arising out of the application or use of any product or circuit, and specifically disclaims any and all liability, including without limitation special, consequential or incidental damages. Buyer is responsible for its products and applications using **onsemi** products, including compliance with all laws, regulations and safety requirements or standards, regardless of any support or applications information provided by **onsemi**. "Typical" parameters which may be provided in **onsemi** data sheets and/or specifications can and do vary in different applications and actual performance may vary over time. All operating parameters, including "Typicals" must be validated for each customer application by customer's technical experts. **onsemi** does not convey any license under any of its intellectual property rights nor the rights of others. **onsemi** products are not designed, intended, or authorized for use as a critical component in life support systems or any FDA Class 3 medical devices or medical devices with a same or similar classification in a foreign jurisdiction or any devices intended for implantation in the human body. Should Buyer purchase or use **onsemi** products for any such unintended or unauthorized application, Buyer shall indemnify and hold **onsemi** and its officers, employees, subsidiaries, affiliates, and distributors harmless against all claims, costs, damages, and expenses, and reasonable attorney fees arising out of, directly or indirectly, any claim of personal injury or death associated with such unintended or unauthorized use, even if such claim alleges that **onsemi** was negligent regarding the design or manufacture of the part. **onsemi** is an Equal Opportunity/Affirmative Action Employer. This literature is subject to all applicable copyright laws and is not for resale in any manner.

PUBLICATION ORDERING INFORMATION

LITERATURE FULFILLMENT:

Email Requests to: orderlit@onsemi.com

onsemi Website: www.onsemi.com

TECHNICAL SUPPORT

North American Technical Support:

Voice Mail: 1 800-282-9855 Toll Free USA/Canada

Phone: 011 421 33 790 2910

Europe, Middle East and Africa Technical Support:

Phone: 00421 33 790 2910

For additional information, please contact your local Sales Representative